

Angle gripper DHWC



Characteristics

At a glance

Further information → [dhwc](#)

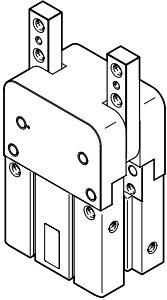

- Lateral gripper jaw support for high torque loads
- Gripper jaw centring options
- Max. repetition accuracy
- Proximity switch for sensing the piston position in the end positions and position transmitter for sensing the piston position at any point
- Wide range of adaptation options on the drives
- Flexible application options: can be used as a double- and single-acting gripper
- Sizing software for gripper selection → www.festo.com

These grippers are not designed for the following or similar application examples:

- Machining
- Aggressive media
- Grinding dust
- Welding spatter

Diagrams

Further information → [dhwc](#)



The diagrams shown in this document are also available online. These can be used to display precise values.

Position sensing

[A] For proximity sensor

By using proximity switches, any position can be detected.

Gripper function

[] Double-acting

Opening or closing by applying compressed air

[S] Single-acting, open

Open when depressurised. Closed when pressurised with compressed air

Gripping force backup

[NO] Opening

Opened by spring force in depressurised state

Type code

001	Series
DHWC	Angle gripper

002	Size [mm]
6	6
10	10
16	16
20	20
25	25
32	32

003	Position sensing
A	For proximity sensor

004	Gripper function
	Double-acting
S	Single-acting, open

005	Gripping force backup
	None
NO	Opening

Datasheet

General technical data

Size	6	10	16	20	25	32
Design	Connection direction at side Force pilot operated motion sequence					
Mode of operation	Double-acting	Double-acting Single-acting Open		Double-acting Open Single-acting	Double-acting Single-acting Open	
Gripper function	Angle					
Number of gripper jaws	2					
Max. opening angle	30 deg					
Pneumatic connection	M3			M5		
Repetition accuracy, gripper ¹⁾	0.1 mm		≤0.1 mm			
Rotationally symmetrical	–		≤0.2 mm			
Max. replacement accuracy	0.2 mm		≤0.2 mm			
Max. operating frequency of gripper	3 Hz		≤3 Hz	≤2 Hz		
Position detection	Via proximity switch					
Type of mounting	Either: Direct mounting via through-hole Direct mounting via thread		Either: Direct mounting via through-hole Direct mounting via thread Via through-hole and dowel pin Via female thread and dowel pin			
Mounting position	optional					

1) Under constant exposure to operating conditions, end-position drift occurs in the direction of movement of the gripper jaws at 100 consecutive strokes

Operating and environmental conditions

Size	6	10	16	20	25	32
Operating medium	Compressed air to ISO 8573-1:2010 [7:4:4]					
Note on operating and pilot medium	Lubricated operation possible (in which case lubricated operation will always be required)					
Ambient temperature ¹⁾	-10 ... 60°C					
Corrosion resistance class CRC ²⁾	0 - No corrosion stress					

1) Note the operating range of the proximity switches

2) More information www.festo.com/x/topic/crc

Operating pressure – DHWC-...

Size	6	10	16	20	25	32
Operating pressure	0.25 ... 0.8 MPa		0.1 ... 0.8 MPa			
Operating pressure	36.25 ... 116 psi		14.5 ... 116 psi			
Operating pressure	2.5 ... 8 bar		1 ... 8 bar			

Operating pressure – DHWC-...-NO

Size	10	16	20	25	32
Operating pressure	0.2 ... 0.8 MPa		0.15 ... 0.8 MPa		
Operating pressure	29 ... 116 psi		21.75 ... 116 psi		
Operating pressure	2 ... 8 bar		1.5 ... 8 bar		

Weight – DHWC-...

Size	6	10	16	20	25	32
Product weight	22 g	48 g	97 g	189.3 g	362 g	639 g

Weight – DHWC-...-NO

Size	10	16	20	25	32
Product weight	53.5 g	97.5 g	190.5 g	363.5 g	642 g

Datasheet

Materials						
Size	6	10	16	20	25	32
Material housing	Anodised wrought aluminium alloy					
Material gripper jaws	High-alloy steel					
Material cover cap	Wrought aluminium alloy, anodised					
Note on materials	RoHS-compliant					

Total gripping torque

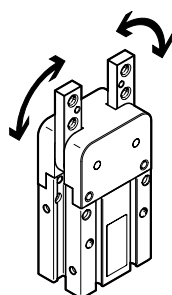

The gripping torque is not constant across the opening angle.

Total gripping torque – DHWC-...						
Size	6	10	16	20	25	32
Total gripping torque at 0.6 MPa (6 bar, 87 psi), opening	7.3 Ncm	25.1 Ncm	78.2 Ncm	173.5 Ncm	322.6 Ncm	687.6 Ncm
Total gripper torque, closing, 0.6 MPa (6 bar, 87 psi)	5.4 Ncm	20.6 Ncm	65.7 Ncm	142.9 Ncm	265.1 Ncm	578.6 Ncm

Total gripping torque – DHWC-...-NO						
Size	10	16	20	25	32	
Total gripper torque, closing, 0.6 MPa (6 bar, 87 psi)	15.9 Ncm	53.3 Ncm	120.9 Ncm	233.9 Ncm	550.7 Ncm	

Static load characteristics on the gripper jaws

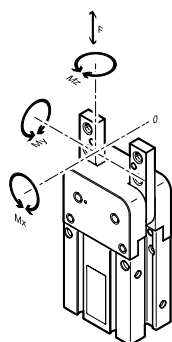

The indicated permissible forces and torques apply to a single gripper jaw. They include the lever arm, additional applied loads created by the workpiece or external gripper fingers and acceleration forces occurring during movement. The zero coordinate line (gripper jaw guide) must be taken into account when calculating torques.

Static load characteristics on the gripper jaws						
Size	6	10	16	20	25	32
Max. force on gripper jaw Fz static	18 N	40 N	60 N	100 N	140 N	210 N
Max. torque at gripper Mx static	0.3 Nm	0.4 Nm	1.2 Nm	1.5 Nm	2.2 Nm	5 Nm
Max. torque at gripper My static	0.3 Nm	0.5 Nm	0.9 Nm	2.2 Nm		5 Nm
Max. torque at gripper Mz static	0.3 Nm	0.5 Nm	0.9 Nm	2.2 Nm		5 Nm

Datasheet

Gripping force F per gripper jaw as a function of operating pressure and lever arm x

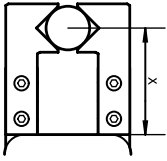

The gripping forces as a function of the operating pressure and lever arm can be determined from the following graphs.

The gripping torque is not constant across the opening angle.

Sizing software for gripper selection → www.festo.com

Gripping force F per gripper jaw as a function of operating pressure and lever arm x – External gripping (closing), double-acting – DHWC-6-A

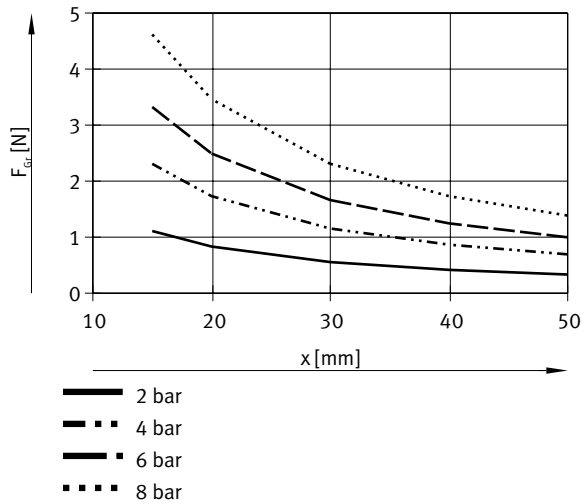

Gripping force F per gripper jaw as a function of operating pressure and lever arm x – External gripping (closing), double-acting – DHWC-10-A

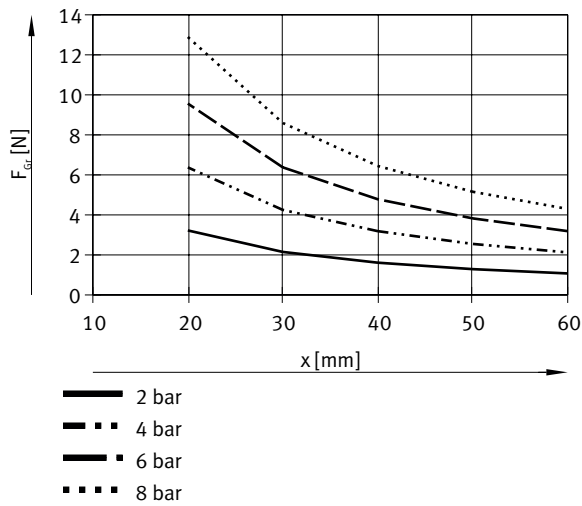

Datasheet

Gripping force F per gripper jaw as a function of operating pressure and lever arm x – External gripping (closing), double-acting – DHWC-16-A

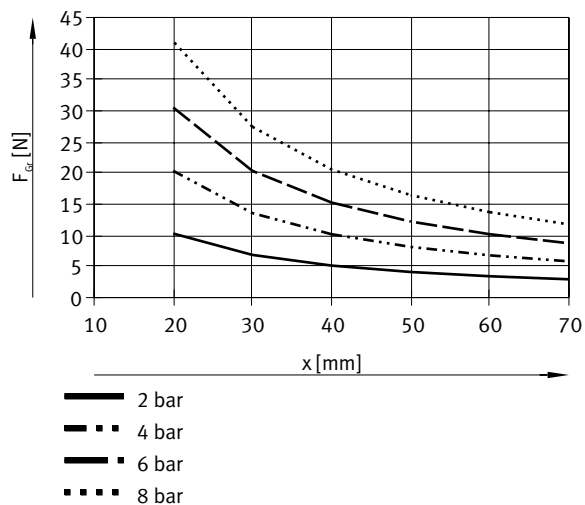

Gripping force F per gripper jaw as a function of operating pressure and lever arm x – External gripping (closing), double-acting – DHWC-20-A

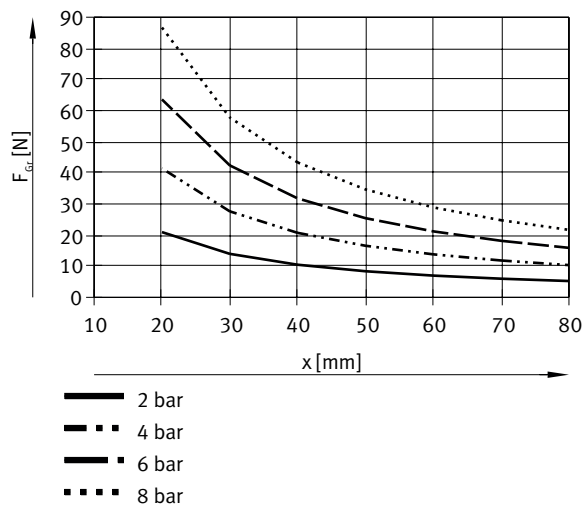

Datasheet

Gripping force F per gripper jaw as a function of operating pressure and lever arm x – External gripping (closing), double-acting – DHWC-25-A

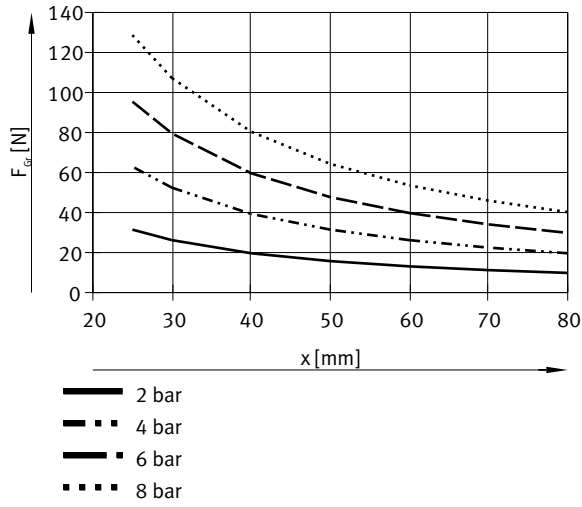

Gripping force F per gripper jaw as a function of operating pressure and lever arm x – External gripping (closing), double-acting – DHWC-32-A

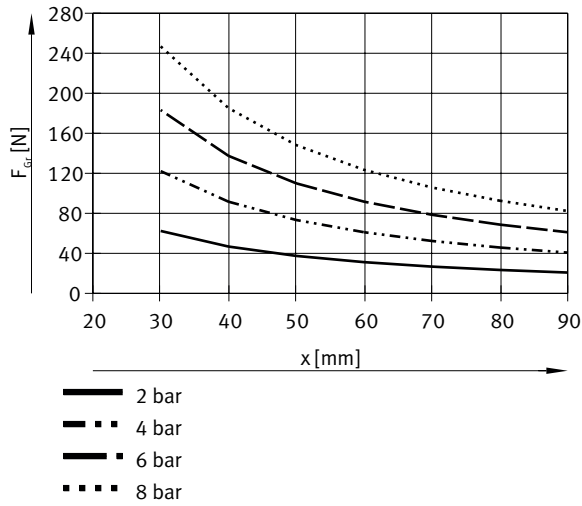

Datasheet

Gripping force F per gripper jaw as a function of operating pressure and lever arm x – External gripping (closing), single-acting – DHWC-10-A-S-NO

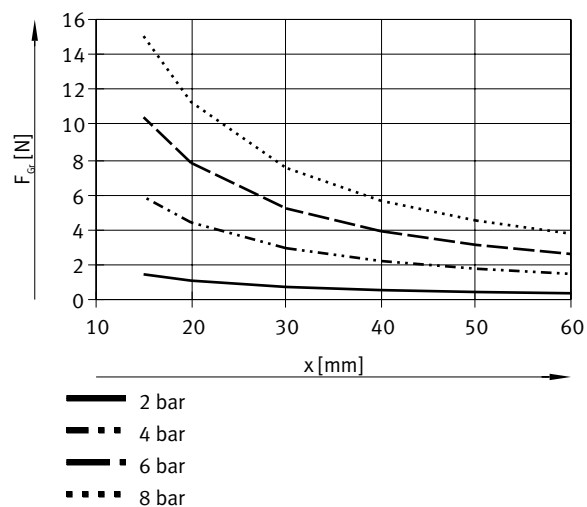

Gripping force F per gripper jaw as a function of operating pressure and lever arm x – External gripping (closing), single-acting – DHWC-16-A-S-NO

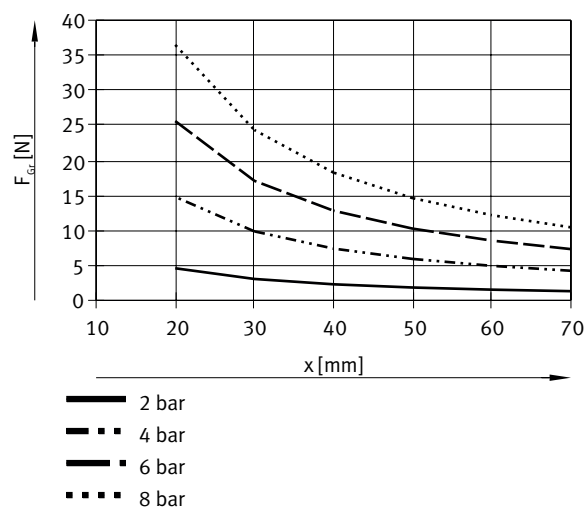

Datasheet

Gripping force F per gripper jaw as a function of operating pressure and lever arm x – External gripping (closing), single-acting – DHWC-20-A-S-NO

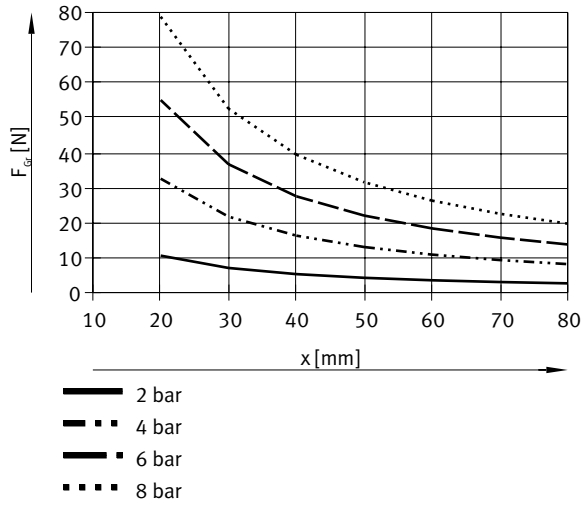

Gripping force F per gripper jaw as a function of operating pressure and lever arm x – External gripping (closing), single-acting – DHWC-25-A-S-NO

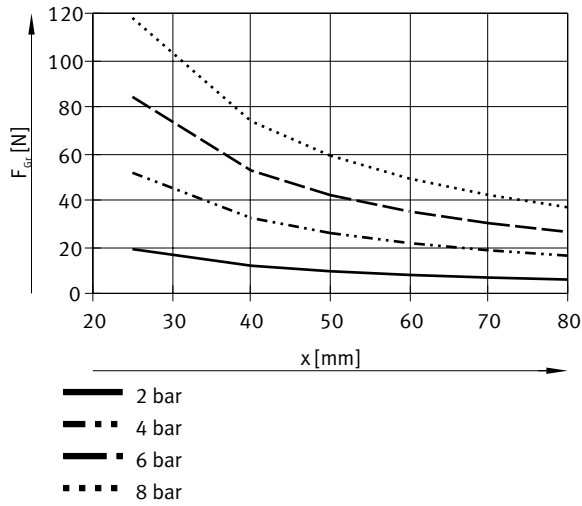

Datasheet

Gripping force F per gripper jaw as a function of operating pressure and lever arm x – External gripping (closing), single-acting – DHWC-32-A-S-NO

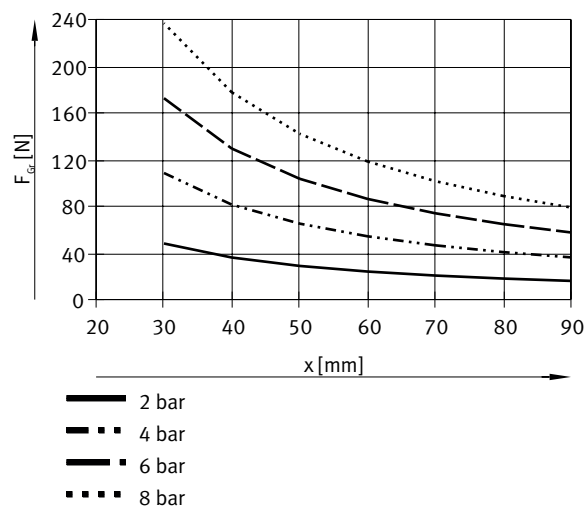

Gripping force F per gripper jaw as a function of operating pressure and lever arm x – Internal gripping (opening), double-acting – DHWC-6-A

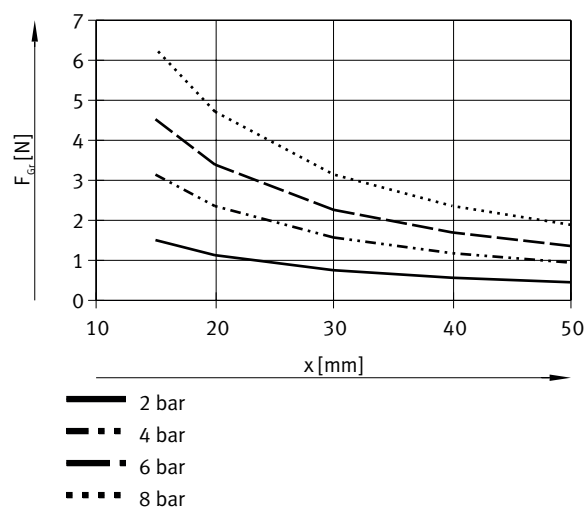

Datasheet

Gripping force F per gripper jaw as a function of operating pressure and lever arm x – Internal gripping (opening), double-acting – DHWC-10-A

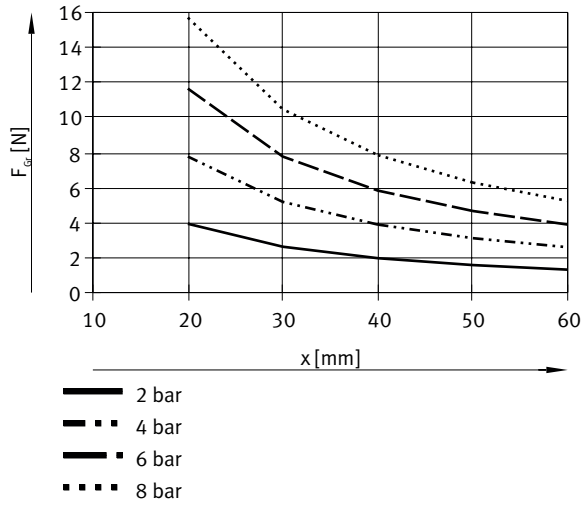

Gripping force F per gripper jaw as a function of operating pressure and lever arm x – Internal gripping (opening), double-acting – DHWC-16-A

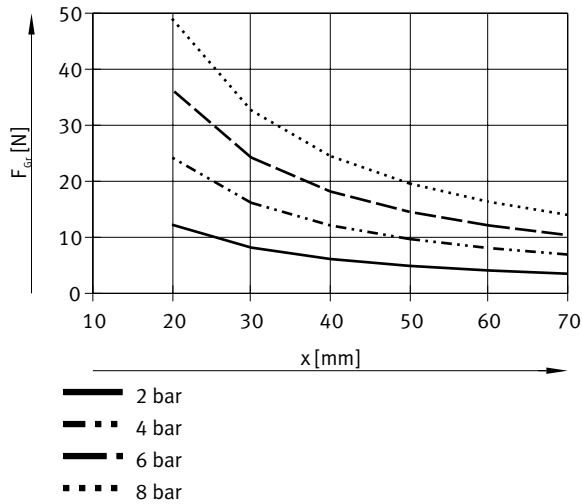

Datasheet

Gripping force F per gripper jaw as a function of operating pressure and lever arm x – Internal gripping (opening), double-acting – DHWC-20-A

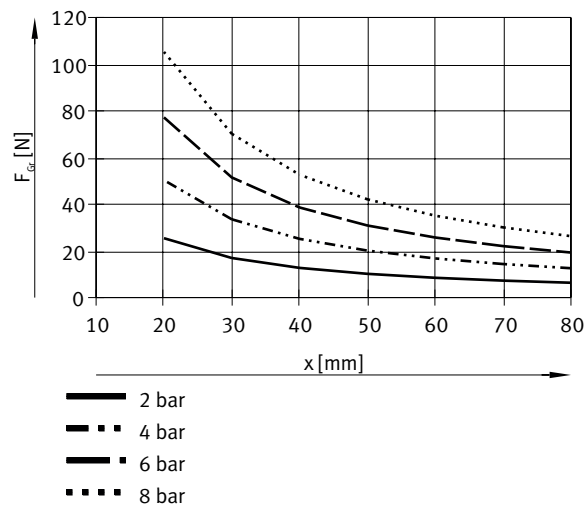

Gripping force F per gripper jaw as a function of operating pressure and lever arm x – Internal gripping (opening), double-acting – DHWC-25-A

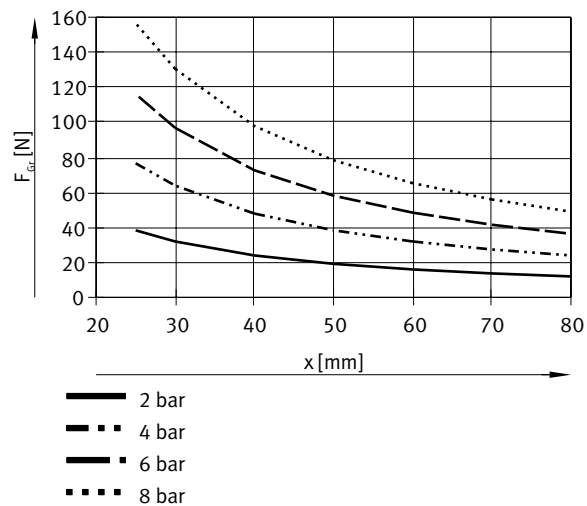

Datasheet

Gripping force F per gripper jaw as a function of operating pressure and lever arm x – Internal gripping (opening), double-acting – DHWC-32-A

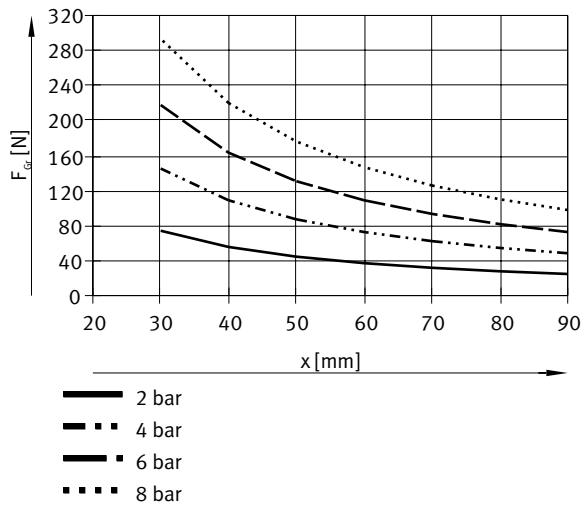

Gripping force F per gripper jaw at 0.6 MPa (6 bar, 87 psi) as a function of lever arm x and eccentricity a and b

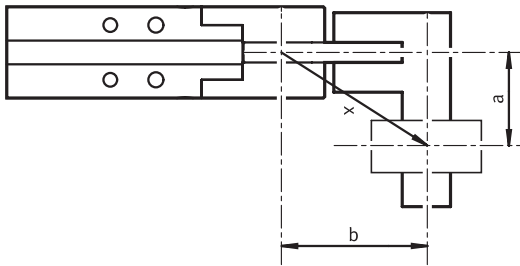

Gripping force F per gripper jaw at 0.6 MPa (6 bar, 87 psi) as a function of lever arm x and eccentricity a and b

$$x = \sqrt{a^2 + b^2} = \sqrt{20^2 + 25^2} = 32 \text{ mm}$$

The formula (on the left) must be used to calculate the lever arm x with eccentric gripping.
 The gripping force F can then be read from the graphs using the calculated value x.

Calculation example:

Assuming:

Distance a = 20 mm

Distance b = 25 mm

To be determined:

The gripping force at 6 bar, with a DHWC-16-A, used as an external gripper.

Datasheet

Gripping force F per gripper jaw at 0.6 MPa (6 bar, 87 psi) as a function of lever arm x and eccentricity a and b

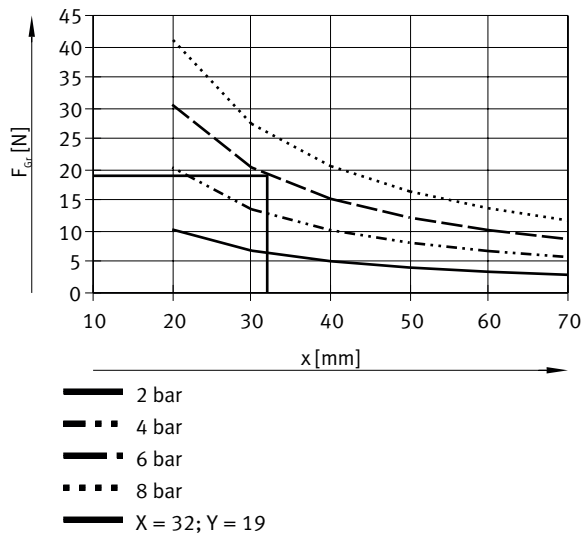

The graph gives a value of $F = 20$ N for the gripping force.

Torque curve M as a function of opening angle

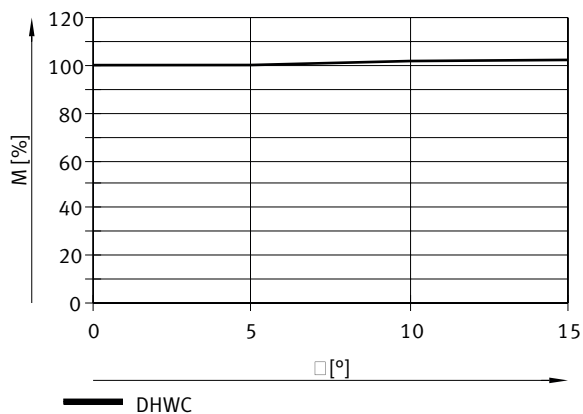

The drive principle of the gripper jaws means that the torque is not constant across the opening angle. The percentage available in each case can be calculated in the graph.

Opening angle of 0° means: parallel gripper jaw position.

Spring moment M as a function of the opening angle

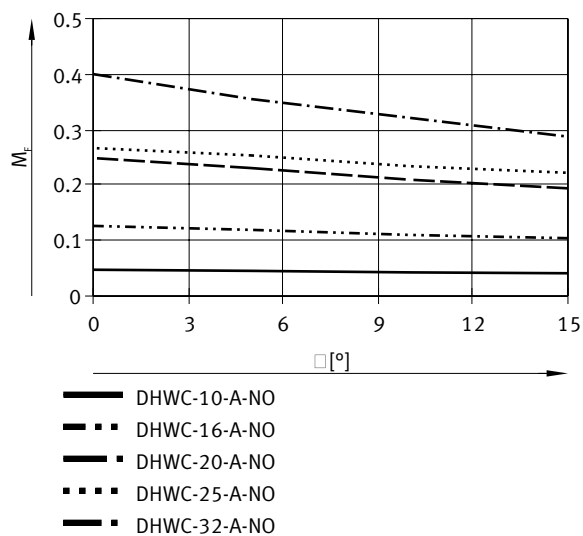

Calculation of the actual gripping torques M for DHWC...-S-NO as a function of the application:

Depending on the requirements, the gripper with built-in spring, DHWC...-S-NO (opening), can be used as a single-acting gripper.

To calculate the available gripping torque $M_{Grtotal}$ (per gripper jaw), the data from the graphs for the gripping force F_{Gr} , the torque curve M and the spring torque M_s must be combined accordingly.

$$M_{Gr} = F_{Gr} \cdot x \cdot M \text{ [%]}$$

- M_{Gr} = Gripping torque
- F_{Gr} = Gripping force
- x = Lever arm
- M = Torque curve

Datasheet

Mass moments of inertia

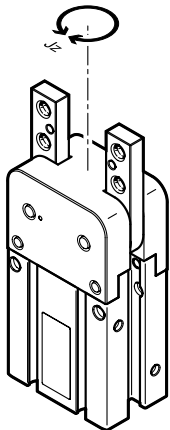

Mass moment of inertia of the gripper in relation to the central axis, without external gripper fingers, with no load.

Mass moments of inertia – DHWC-...

Size	6	10	16	20	25	32
Mass moment of inertia	0.009 kgcm ²	0.035 kgcm ²	0.115 kgcm ²	0.253 kgcm ²	1.083 kgcm ²	2.769 kgcm ²

Mass moments of inertia – DHWC-...-NO

Size	10	16	20	25	32
Mass moment of inertia	0.039 kgcm ²	0.116 kgcm ²	0.255 kgcm ²	1.087 kgcm ²	2.782 kgcm ²

Opening and closing times

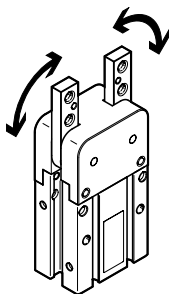

The indicated opening and closing times [ms] were measured at room temperature at an operating pressure of 0.6 MPa (6 bar, 87 psi) with a horizontally mounted gripper and without additional gripper fingers (mean values shown).

The grippers must be throttled for larger applied loads. Opening and closing times must then be adjusted accordingly.

Opening and closing times – DHWC-...

Size ¹⁾	6	10	16	20	25	32
Min. opening time at 0.6 MPa (6 bar, 87 psi)	4 ms	8 ms	4 ms	6 ms	38 ms	22 ms
Min. closing time at 0.6 MPa (6 bar, 87 psi)	7 ms	8 ms	12 ms	16 ms	50 ms	34 ms

¹⁾ The indicated opening and closing times [ms] were measured at room temperature, at an operating pressure of 6 bar and with the gripper installed horizontally without additional gripper fingers. The grippers must be throttled for higher masses [g]. Opening and closing times must then be adjusted accordingly.

Opening and closing times – DHWC-...-NO

Size ¹⁾	10	16	20	25	32
Min. opening time at 0.6 MPa (6 bar, 87 psi)	6 ms	20 ms	13 ms	51 ms	43 ms
Min. closing time at 0.6 MPa (6 bar, 87 psi)	12 ms	14 ms	10 ms	15 ms	16 ms

¹⁾ The indicated opening and closing times [ms] were measured at room temperature, at an operating pressure of 6 bar with the gripper mounted horizontally and without additional gripper fingers. The grippers must be throttled for higher masses [g]. Opening and closing times must then be adjusted accordingly.

Datasheet

Opening and closing times T to be set at 0.6 MPa (6 bar, 87 psi) as a function of mass moment of inertia of the gripper fingers – DHWC-6

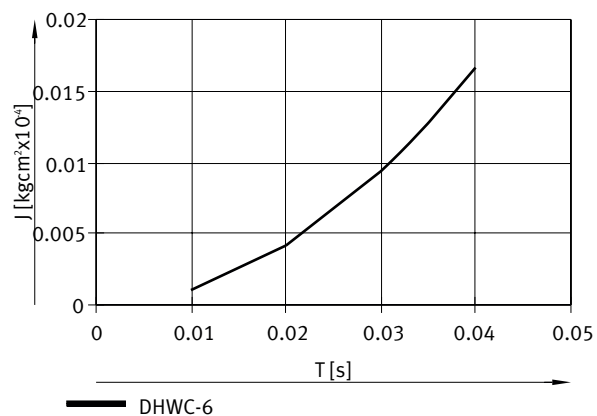

Opening and closing times T to be set at 0.6 MPa (6 bar, 87 psi) as a function of mass moment of inertia of the gripper fingers – DHWC-10

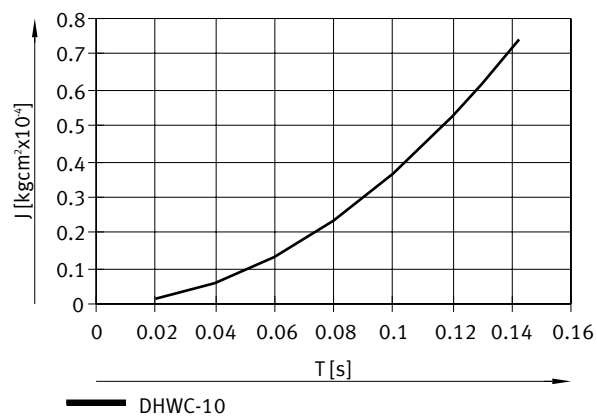

Opening and closing times T to be set at 0.6 MPa (6 bar, 87 psi) as a function of mass moment of inertia of the gripper fingers – DHWC-16

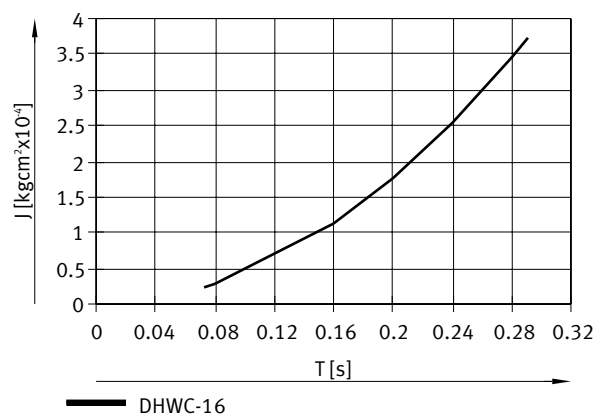

Datasheet

Opening and closing times T to be set at 0.6 MPa (6 bar, 87 psi) as a function of mass moment of inertia of the gripper fingers – DHWC-20

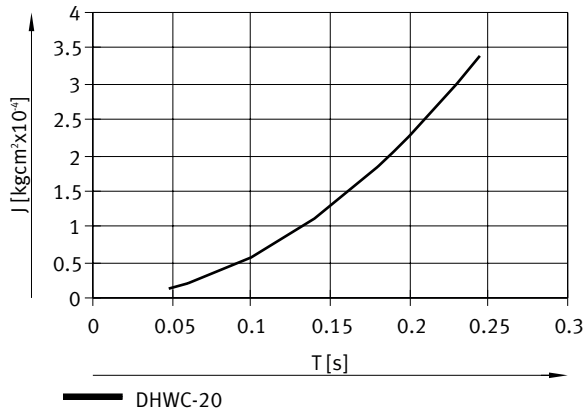

Opening and closing times T to be set at 0.6 MPa (6 bar, 87 psi) as a function of mass moment of inertia of the gripper fingers – DHWC-25

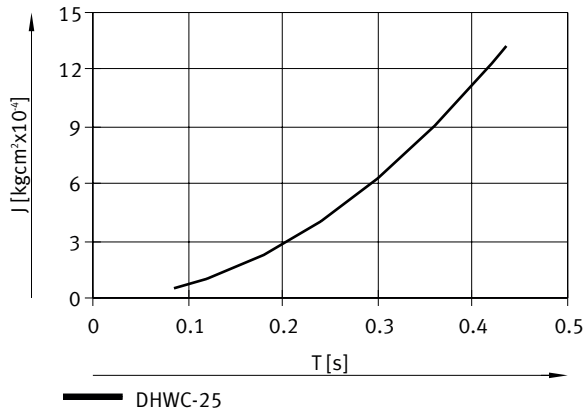

Opening and closing times T to be set at 0.6 MPa (6 bar, 87 psi) as a function of mass moment of inertia of the gripper fingers – DHWC-32

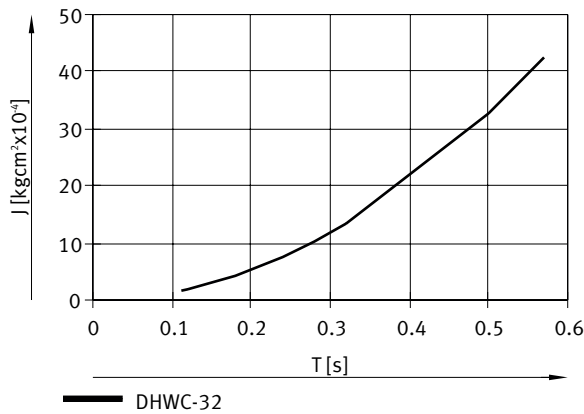

Dimensions

Dimensions – DHWC-6

Download CAD data → www.festo.com

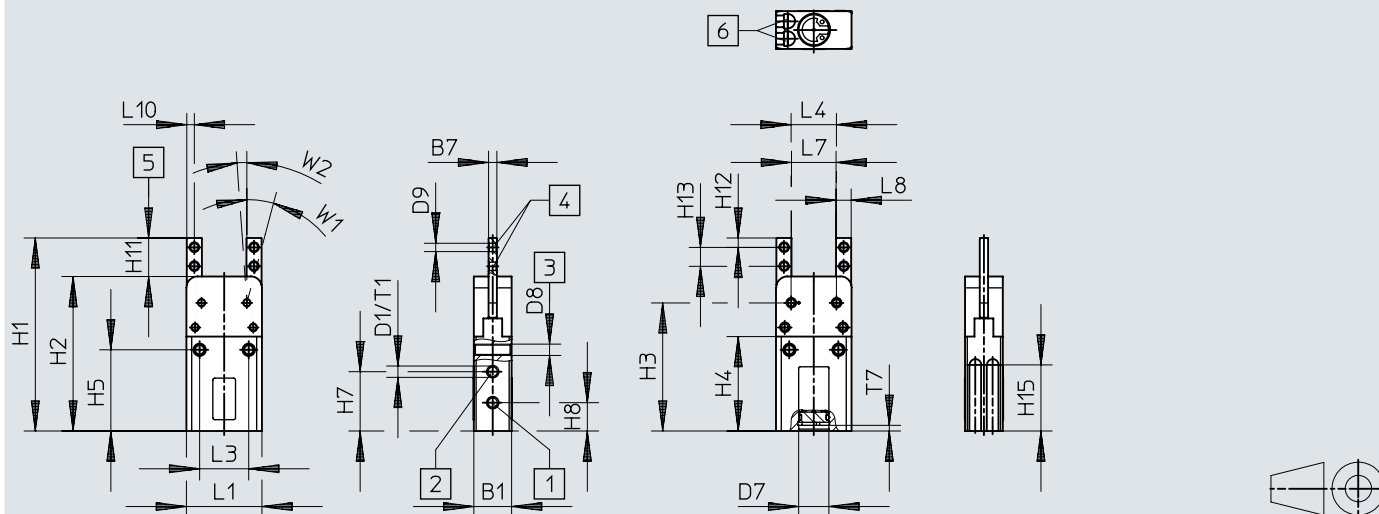

- [1] Open pneumatic connection
- [2] Close pneumatic connection
- [3] Threaded hole for mounting the gripper
- [4] Hole for mounting gripper fingers
- [5] Area for mounting gripper fingers
- [6] C-slot for proximity switch

	B1	B7	D1	D7	D8	D9	H1	H2	H3	H4	H5	H7	H8	H11
	+0,3	-0,01 -0,05		∅ H8		∅								-0,2
DHWC-6-A	10	2,2	M3	8	M3	2,2 ^{+0,1}	51,1	40,9	33,9	25	21,5	15,7	7,5	10,2

	H12	H13	H15	L1	L3	L4	L7	L8	L10	T1	T7	W1	W2
	-0,2			+0,3			-0,4	-0,4	+0,025 -0,225			±2°	+3°
DHWC-6-A	2,5	5	17,5	20	13	12	11,8	4	2	4,5	1,5	15°	2°

Dimensions

Dimensions – DHWC-10 ... 32

Download CAD data → www.festo.com

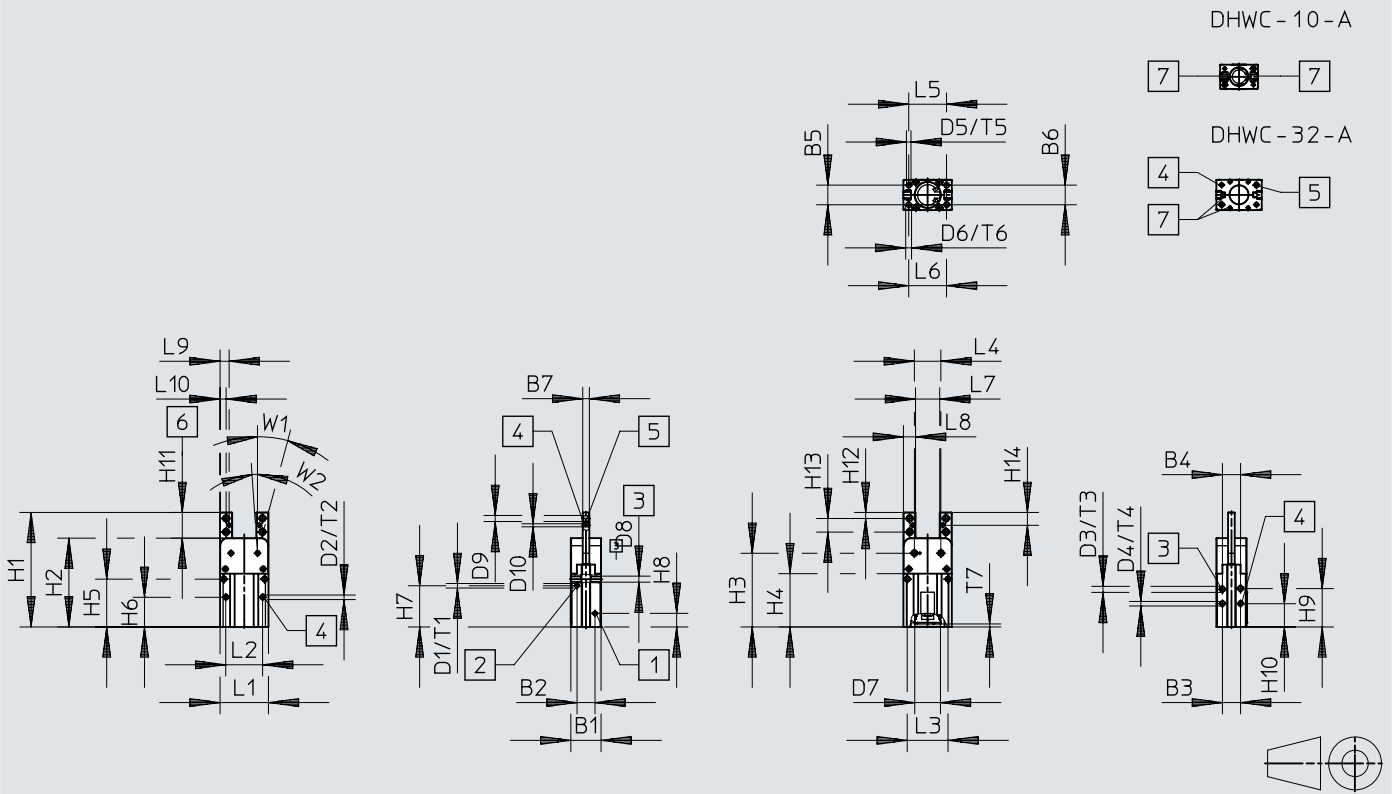

DHWC - 10 - A



DHWC - 32 - A



- [1] Open pneumatic connection
- [2] Close pneumatic connection
- [3] Threaded hole for mounting the gripper
- [4] Centring hole
- [5] Threaded hole for mounting gripper fingers
- [6] Area for mounting gripper fingers
- [7] DHWC-10: T-slot for proximity switches, DHWC-16 ... 32: Round slot and T-slot for proximity switches

Dimensions

	B1 +0,3	B2	B3 ±0,02	B4	B5	B6 ±0,02	B7 -0,01 -0,05	D1	D2 ∅ H9	D3	D4 ∅ H9	D5 ∅ H9	D6	D7 ∅ H8	D8	D9	D10 ∅ +0,02
DHWC-10-A	16	10,8	10,8	10,8	10,8	10,8	3	M3	2	M3	2	2	M3	12	M3	3,2 ^{+0,1}	2
DHWC-10-A-S-NO																	
DHWC-16-A	20	11,9	12	12	13	13	4,4	M3	3	M4	3	3	M4	17	M4	M4	3
DHWC-16-A-S-NO																	
DHWC-20-A	26	15,6	16	14	16,6	17	5,6	M5	4	M5	4	4	M5	21	M5	M5	3
DHWC-20-A-S-NO																	
DHWC-25-A	33	20,4	21	21	20	20	6,6	M5	4	M6	5	5	M6	26	M6	M5	3
DHWC-25-A-S-NO																	
DHWC-32-A	40	24	26	26	26	26	8,6	M5	5	M6	5	5	M6	25	M6	M6	3
DHWC-32-A-S-NO																	

	H1	H2	H3	H4	H5	H6 +0,1	H7	H8	H9	H10 +0,1	H11 -0,2	H12 -0,2	H13	H14 -0,2	L1 +0,3	L2 ±0,02	L3
DHWC-10-A	62,4	46,8	38,1	-	21,6	11,6	15,6	7	16,1	8,5	15,6	3,5	8,6	7,8	25	18	18,6
DHWC-10-A-S-NO	68,3	52,7	44		27,5	17,5	21,5		22	14,4							
DHWC-16-A	75,8	58,8	48,8	35,3	31,7	19,7	27,3	9	25,4	15,4	17	4	9	8,5	32	24,4	27
DHWC-16-A-S-NO																	
DHWC-20-A	87,4	68,4	55,9	39,9	35,9	21,9	30	10,2	28,8	16,8	19	5	9	9,5	40	28,4	31,6
DHWC-20-A-S-NO																	
DHWC-25-A	103,2	80,2	65	46,2	41,5	25,8	34,5	10,5	32,9	20,9	23	5,5	12	11,5	50	37,2	37,4
DHWC-25-A-S-NO																	
DHWC-32-A	117	89,3	69,3	46,7	42,2	25,2	34,2	11	33,2	20,2	27,7	6	16	14	60	46	46
DHWC-32-A-S-NO																	

	L4	L5 ±0,02	L6	L7 -0,4	L8 -0,4	L9 +0,025 -0,225	L10 -0,2	T1	T2	T3	T4	T5	T6	T7	W1 ±2°	W2 +3°
DHWC-10-A	14	19	19	13	6	3	3	4	3	4	3	3	4	1,5	15°	2°
DHWC-10-A-S-NO																
DHWC-16-A	17,6	25	25	16	8	6	4	4,5	3	4,5	3	3	6	2	15°	2°
DHWC-16-A-S-NO																
DHWC-20-A	24,8	31	30	22	9	6	4,5	6	4	8	4	4	10	2	15°	2°
DHWC-20-A-S-NO																
DHWC-25-A	31	38	38	30	10	5	5	7,5	4	10	4	4	12	2	15°	2°
DHWC-25-A-S-NO																
DHWC-32-A	38	46	46	36	12	6	6	7,5	5	10	5	5	13	2	15°	2°
DHWC-32-A-S-NO																

Ordering data

DHWC-6...				
	Size	Mode of operation	Part no.	Type
	6	Double-acting	8125286	DHWC-6-A

DHWC-10...				
	Size	Mode of operation	Part no.	Type
	10	Double-acting	8125481	DHWC-10-A
		Single-acting, Open	8133476	DHWC-10-A-S-NO

DHWC-16 ... 32...				
	Size	Mode of operation	Part no.	Type
	16	Double-acting	8128711	DHWC-16-A
		Single-acting, Open	8128709	DHWC-16-A-S-NO
	20	Double-acting	8128701	DHWC-20-A
		Open, Single-acting	8128702	DHWC-20-A-S-NO
	25	Double-acting	8128136	DHWC-25-A
		Single-acting, Open	8133477	DHWC-25-A-S-NO
	32	Double-acting	8128105	DHWC-32-A
		Single-acting, Open	8133475	DHWC-32-A-S-NO

Peripherals

Size: 6

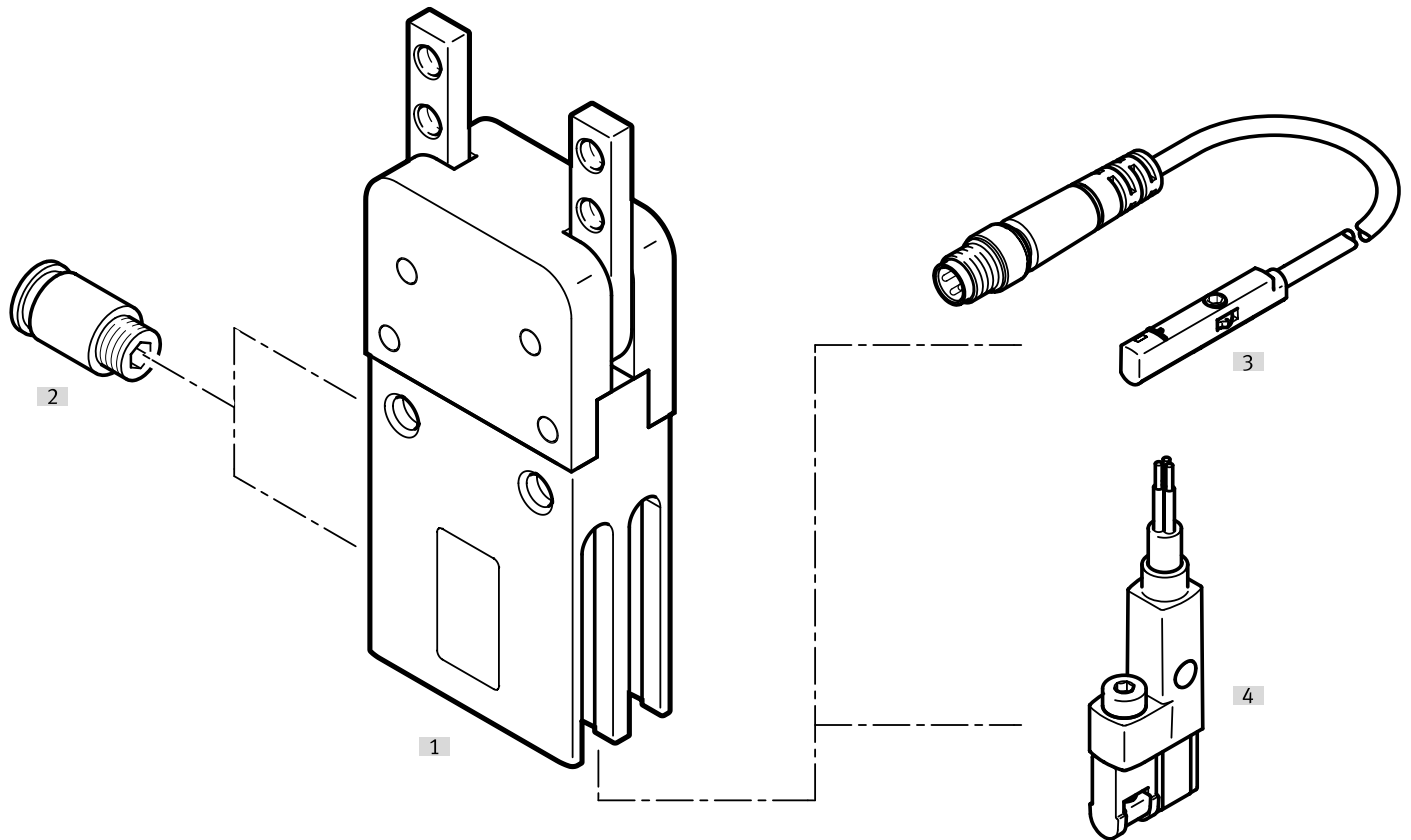

Accessories			→ Page/Internet
Type/order code	Description		
[1] Angle grippers DHWC	Double-acting or single-acting		dhwc
[2] Push-in fitting QS	For connecting tubing with standard O.D.		qs
[3] Proximity switch SMT-10M	For sensing the piston position in the end positions		26
[4] Proximity switch SMT-10G	For sensing the piston position in the end positions		26

Peripherals

Size 10

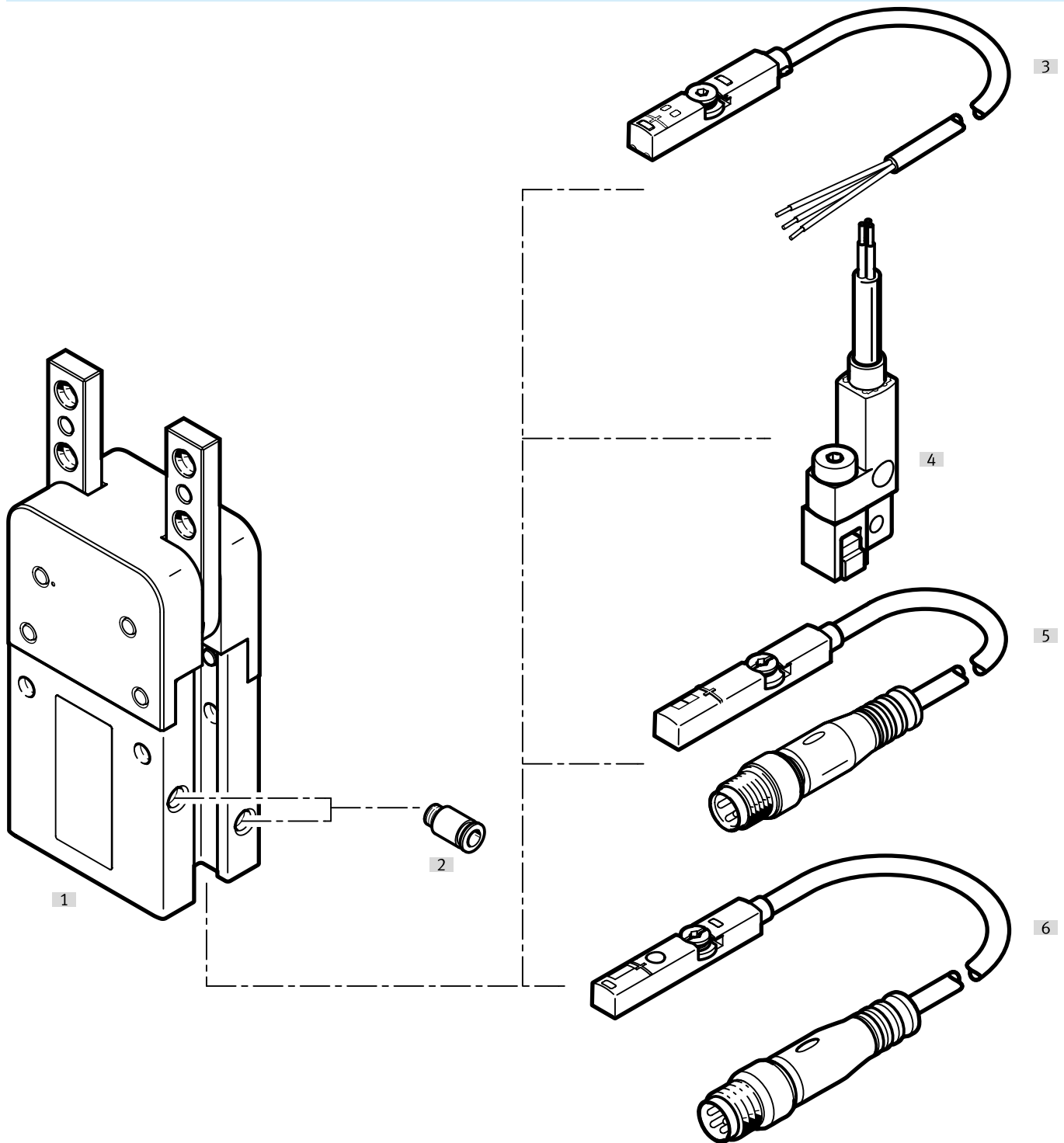

Accessories			→ Page/Internet
Type/order code	Description		
[1] Angle grippers DHWC	Double-acting		dhwc
[2] Push-in fitting QS	For connecting tubing with standard O.D		qs
[3] Proximity switch SMT-8M	For sensing the piston position in the end positions		26
[4] Proximity switch SMT-8G	For sensing the piston position in the end positions		26
[5] Position transmitter SMAT-8M	For sensing the piston position at any point		27
[6] Position transmitter SDAS-MHS	For sensing the piston position at any point		27

Peripherals

Size 16 ... 32

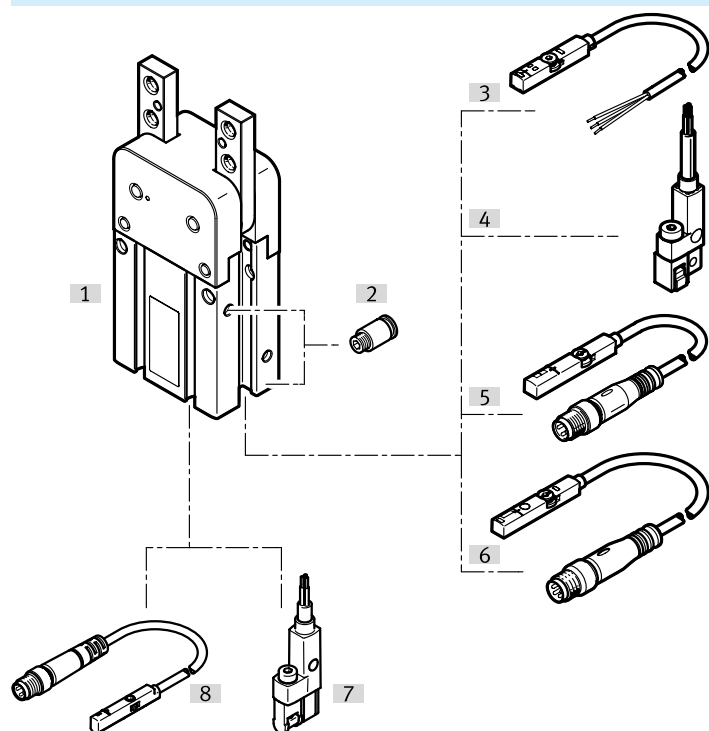

Accessories			→ Page/Internet
Type/order code	Description		
[1] Angle grippers DHWC	Double-acting or single-acting		dhwc
[2] Push-in fitting QS	For connecting tubing with standard O.D		qs
[3] Proximity switch SMT-8M	For sensing the piston position in the end positions		26
[4] Proximity switch SMT-8G	For sensing the piston position in the end positions		26
[5] Position transmitter SMAT-8M	For sensing the piston position at any point		27
[6] Position transmitter SDAS-MHS	For sensing the piston position at any point		27
[7] Proximity switch SMT-10G	For sensing the piston position in the end positions		26
[8] Proximity switch SMT-10M	For sensing the piston position in the end positions		26

Accessories

Proximity switch SMT-10M for round slot, magneto-resistive – for sizes 6, 16 ... 32

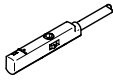
	Type of mounting	Switching output	Electrical connection	Cable length	Part no.	Type	
	Screw-clamped, Insertable in the slot from above	3-wire PNP N/O contact	Open end	2.5 m	551374	SMT-10M-PS-24V-E-2,5-Q-OE	
					★ 551373	SMT-10M-PS-24V-E-2,5-L-OE	
			Plug M8, A-coded	Open end	0.3 m	★ 551375	SMT-10M-PS-24V-E-0,3-L-M8D
						551376	SMT-10M-PS-24V-E-0,3-Q-M8D

Proximity switch SMT-10G for round slot, magneto-resistive – for sizes 6, 16 ... 32

	Type of mounting	Switching output	Electrical connection	Cable length	Part no.	Type
	Clamped in C-slot, Insertable in the slot lengthwise	3-wire NPN N/O contact	Open end	2.5 m	8065030	SMT-10G-NS-24V-E-2,5Q-OE
			Plug M8, A-coded	0.3 m	8065029	SMT-10G-NS-24V-E-0,3Q-M8D
		3-wire PNP N/O contact	Open end	2.5 m	547862	SMT-10G-PS-24V-E-2,5Q-OE
			Plug M8, A-coded	0.3 m	547863	SMT-10G-PS-24V-E-0,3Q-M8D

Proximity switch SMT-8M for T-slot, magneto-resistive – for sizes 10 ... 32

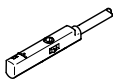
	Type of mounting	Switching output	Electrical connection	Cable length	Part no.	Type
	Screw-clamped, Insertable in the slot from above	3-wire NPN N/O contact	Open end	2.5 m	★ 574338	SMT-8M-A-NS-24V-E-2,5-OE
			Plug M8, A-coded	0.3 m	★ 574339	SMT-8M-A-NS-24V-E-0,3-M8D
		3-wire PNP N/C contact	Open end	7.5 m	★ 574340	SMT-8M-A-PO-24V-E-7,5-OE
				2.5 m	★ 574335	SMT-8M-A-PS-24V-E-2,5-OE
		3-wire PNP N/O contact	Plug M8, A-coded	0.3 m	★ 574334	SMT-8M-A-PS-24V-E-0,3-M8D
			Plug M12, A-coded		★ 574337	SMT-8M-A-PS-24V-E-0,3-M12

Proximity switch SMT-8G for T-slot, magneto-resistive – for sizes 10 ... 32

	Type of mounting	Switching output	Electrical connection	Cable length	Part no.	Type
	Clamped in T-slot, Insertable in the slot lengthwise	3-wire NPN N/O contact	Open end	2.5 m	8065028	SMT-8G-NS-24V-E-2,5Q-OE
			Plug M8, A-coded	0.3 m	8065027	SMT-8G-NS-24V-E-0,3Q-M8D
		3-wire PNP N/O contact	Open end	2.5 m	547859	SMT-8G-PS-24V-E-2,5Q-OE
			Plug M8, A-coded	0.3 m	547860	SMT-8G-PS-24V-E-0,3Q-M8D

Connecting cable NEBU, straight, connection M8

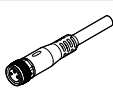
	Electrical connection 1, connector system	Electrical connection 2, connector system	Electrical connection 2, number of connections/ cores	Cable length	Part no.	Type
	M8x1, A-coded, to EN 61076-2-104	Open end	3	2.5 m	★ 541333	NEBU-M8G3-K-2.5-LE3
				5 m	★ 541334	NEBU-M8G3-K-5-LE3

Accessories

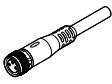
Connecting cable NEBU, straight, connection M12						
	Electrical connection 1, connector system	Electrical connection 2, connector system	Electrical connection 2, number of connections/cores	Cable length	Part no.	Type
	M12x1, A-coded to EN 61076-2-101	Open end	3	2.5 m	★ 541363	NEBU-M12G5-K-2.5-LE3
				5 m	★ 541364	NEBU-M12G5-K-5-LE3

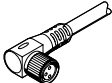
Connecting cable NEBU, angled, connection M8						
	Electrical connection 1, connector system	Electrical connection 2, connector system	Electrical connection 2, number of connections/cores	Cable length	Part no.	Type
	M8x1, A-coded, to EN 61076-2-104	Open end	3	2.5 m	★ 541338	NEBU-M8W3-K-2.5-LE3
				5 m	★ 541341	NEBU-M8W3-K-5-LE3

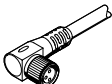
Connecting cable NEBU, angled, connection M12						
	Electrical connection 1, connector system	Electrical connection 2, connector system	Electrical connection 2, number of connections/cores	Cable length	Part no.	Type
	M12x1, A-coded to EN 61076-2-101	Open end	3	2.5 m	541367	NEBU-M12W5-K-2.5-LE3
				5 m	541370	NEBU-M12W5-K-5-LE3

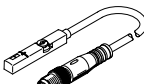
Position transmitter SMAT-8M for T-slot, plug M8, A-coded – for size 10 ... 32						
	Sensing range	Analogue output	Electrical connection 1, number of connections/cores	Cable length	Part no.	Type
	52 mm	0 - 10 V	4	0.3 m	553744	SMAT-8M-U-E-0,3-M8D

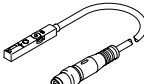
Position transmitter SDAS for T-slot, M8 plug, A-coded – for size 10 ... 32						
	Description	Sensing range	Electrical connection 1, number of connections/cores	Cable length	Part no.	Type
	Operating modes: two adjustable switching outputs; IO-Link®	52 mm	4	0.3 m	8063974	SDAS-MHS-M40-1L-PNLK-PN-E-0.3-M8
				2.5 m	8063975	SDAS-MHS-M40-1L-PNLK-PN-E-2.5-LE

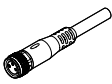
Connecting cables NEBU, straight						
	Electrical connection 1, connector system	Electrical connection 2, connector system	Electrical connection 2, number of connections/cores	Cable length	Part no.	Type
	M8x1, A-coded, to EN 61076-2-104	Open end	4	2.5 m	541342	NEBU-M8G4-K-2.5-LE4

Accessories

Connecting cables NEBU, straight

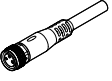
	Electrical connection 1, connector system	Electrical connection 2, connector system	Electrical connection 2, number of connections/cores	Cable length	Part no.	Type
	M8x1, A-coded, to EN 61076-2-104	Open end	4	5 m	541343	NEBU-M8G4-K-5-LE4

Connecting cables NEBU, angled

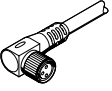
	Electrical connection 1, connector system	Electrical connection 2, connector system	Electrical connection 2, number of connections/cores	Cable length	Part no.	Type
	M8x1, A-coded, to EN 61076-2-104	Open end	4	2.5 m	541344	NEBU-M8W4-K-2.5-LE4
				5 m	541345	NEBU-M8W4-K-5-LE4