



Standard cylinder——SGC Series

In accordance with ISO15552 standard

Compendium of SGC Series

ISO15552(Original ISO6431) Standard cylinder

Bore size:125, 160, 200, 250

Multi-kinds of Seals Material

Adjustable air buffer

With adjustable air buffer on the front and back cover

Tie rod cylinder

The cylinder barrel and front/rear cap are jointed by tie rods with high reliability.

Convenient and fast fix sensor switch

Sensor switch can be directly fixed onto the cylinder, which is convenient and fast.
the counterpart sensor switch type is: CMSG, DMSG, EMSG

Three kinds of cylinder joints

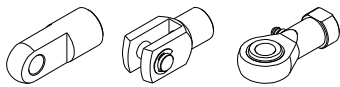

I Knuckle Y Knuckle Universal Joint

Multi-type cylinder



SGC: Double acting type



SGCD: Double rod type



SGCJ: Adjustable stroke type

Multi-mounting accessories

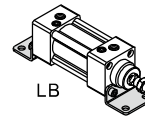

LB

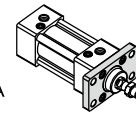

FA

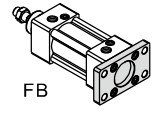

FB

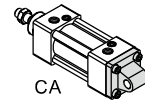

CA

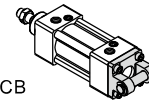

CB

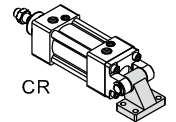

CR

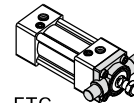

FTC

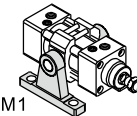

TCM1



TCM2

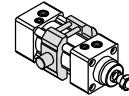

TC

Criteria for selection: Cylinder thrust

Unit : Newton(N)

Bore size	Rod size	Acting type	Pressure area(mm ²)	Operating pressure(MPa)								
				0.1	0.2	0.3	0.4	0.5	0.6	0.7	0.8	0.9
125	32	Double acting Push side	12272	1227.2	2454.4	3681.6	4908.8	6136.0	7363.2	8590.4	9817.6	11044.8
		Double acting Pull side	11468	1146.8	2293.6	3440.4	4587.2	5734.0	6880.8	8027.6	9174.4	10321.2
160	40	Double acting Push side	20106	2010.6	4021.2	6031.8	8042.4	10053.0	12063.6	14074.2	16084.8	18095.4
		Double acting Pull side	18849	1884.9	3769.8	5654.7	7539.6	9424.5	11309.4	13194.3	15079.2	16964.1
200	40	Double acting Push side	31416	3141.6	6283.2	9424.8	12566.4	15708.0	18849.6	21991.2	25132.8	28274.4
		Double acting Pull side	30157	3015.7	6031.4	9047.1	12062.8	15078.5	18094.2	21109.9	24125.6	27141.3
250	50	Double acting Push side	49086	4908.6	9817.2	14725.8	19634.4	24543.0	29451.6	34360.2	39268.8	44177.4
		Double acting Pull side	47123	4712.3	9424.6	14136.9	19045.5	23757.8	28470.1	33182.4	37894.7	42607.0

Installation and application



- When load changes in the work, the cylinder with abundant output capacity shall be selected.
- Relative cylinder with high temperature resistance or corrosion resistance shall be chosen under the condition of high temperature or corrosion.
- Necessary protection measure shall be taken in the environment with higher humidity, much dust or water drops, oil dust and welding dregs.
- Dirty substances in the pipe must be eliminated before cylinder is connected with pipeline to prevent the entrance of particles into the cylinder.
- The medium used by cylinder shall be filtered to 40μm or below.
- Anti-freezing measure shall be adopted under low temperature environment to prevent moisture freezing.
- The cylinder shall be carried out test run without load before application. Prior to run, buffer shall be turned to the minimum and gradually released to avoid the damage on cylinder caused by excessive impact.
- The cylinder shall avoid the influence of side load in operation to maintain the normal work of cylinder and extend the service life.
- If the cylinder is dismantled and stored for a long time, please conduct anti-rust treatment to the surface. Anti-dust caps shall be added in air inlet and outlet ports.



ISO15552 Standard cylinder

SGC Series



Specification

Bore size(mm)	125	160	200	250
Acting type	Double acting			
Fluid	Air(to be filtered by 40μm filter element)			
Mounting type	SGC	Basic FA FB CA CB CR LB TC FTC TCM1 TCM2		
	SGCD, SGCJ	Basic FA LB TC FTC TCM1 TCM2		
Operating pressure	0.15~1.0MPa(22~145psi)(1.5~10,0bar)			
Proof pressure	1.5MPa(215psi)(15bar)			
Temperature °C	-20~70			
Speed range mm/s	30~500			
Stroke tolerance	0~250 ^{+1.0} ₀ 251~1000 ^{+1.5} ₀ 1001~1500 ^{+2.0} ₀			
Cushion type	Variable cushion			
Adjustable cushion stroke	40	50	60	
Port size [Note1]	1/2"	3/4"	1"	

[Note1] PT thread, G thread are available.
Add) Refer to P362 for detail of sensor switch.

Symbol

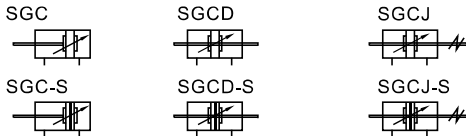

Product feature

- ISO15552 (original ISO6431) standard cylinder.
- The seal of piston adopts heterogeneous two way seal structure. It's dimension is tight and it has the function of oil reservation.
- SGC series cylinders are made of aluminum pipe.
- The buffer adjustment of cylinder is smooth and steady.
- Cylinders and accessories for installation with several specifications are optional.
- The seal material with high temperature resistance is adopted, operating temperature range is 0~150°C.

Stroke

Bore size (mm)	Standard stroke (mm)																Max.std stroke	Max. stroke					
125	25	50	75	80	100	125	150	160	175	200	250	300	350	400	450	500	600	700	800	900	1000	1500	1800
160	25	50	75	80	100	125	150	160	175	200	250	300	350	400	450	500	600	700	800	900	1000	1500	2000
200	25	50	75	80	100	125	150	160	175	200	250	300	350	400	450	500	600	700	800	900	1000	1500	2000
250	25	50	75	80	100	125	150	160	175	200	250	300	350	400	450	500	600	700	800	900	1000	1500	2000

[Note] Consult us for non-standard stroke.

Ordering code

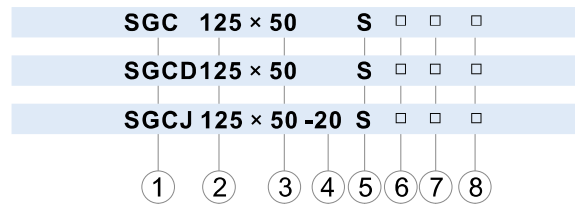

① Model	② Bore size	③ Stroke	④ Adjustable stroke	⑤ Magnet	⑥ Mounting type[Note1]	⑦ Seals Material	⑧ Thread type
SGC: Double acting type (Aluminum barrel)	125 160 200 250	Refer to stroke table for details	No this code	Blank: Without magnet S: With magnet	Blank	Blank: TPU [Note2] H: Viton N: NBR	Blank: PT G: G
SGCD: Double rod type (Aluminum barrel)					LB		
SGCJ: Adjustable stroke type (Aluminum barrel)					FA		
	FB						
	CA						
	CB						
	CR						
	FTC						
	TC						
	Blank						
	LB						
	FA						
	FTC						
	TC						

[Note1] CR is used with CB. FTC, TC are used with TCM1, TCM2. Please refer to page 31~33 for details. [Note2] TPU seals are not available for SGC250.

ISO15552 Standard cylinder

SGC Series

Inner structure and material of major parts

SGC

NO.	Item	Material
1	Rod nut	Carbon steel
2	Piston rod	Carbon steel with 20μm chrome plated
3	Front cover packing	NBR(SGC250)\TPU(Other)
4	Bushing	Wear resistant material
5	Front cover	Aluminum alloy
6	O-ring	NBR
7	Buffer gasket	NBR(SGC250)\TPU(Other)
8	Wear ring	Wear resistant material
9	O-ring	NBR
10	Magnet	Rubber
11	Piston Seal	NBR
12	Screw	Carbon steel
13	Piston	Aluminum alloy
14	Barrel	Aluminum alloy
15	Back cover	Aluminum alloy
16	Tie-rod	Carbon steel
17	Tie-rod nut	Carbon steel

Dimensions

SGC

Bore size\Item	A	AB	AC	AD	AE	B	D	DA	E	EA	F	FA	H	K	KA	KB	M	MA	N	NA	P	PA	PB
125	279	119	160	46	46	140	32	74	M27×2.0	54	41	13.5	27	M12	31	110	60	45	60	4	1/2"	23	14
160	332	152	180	50	50	180	40	94	M36×2.0	72	55	18	36	M16	30	140	65	58	65	4	3/4"	25	15
200	347	167	180	50	50	220	40	100	M36×2.0	72	55	18	36	M16	30	175	75	67	75	5	3/4"	25	15
250	389	189	200	58	58	282	50	111	M42×2.0	84	65	21	46	M20	35	220	90	78	90	8	1"	31	22

Remark: The dimensions of magnet type cylinder are the same as non-magnet type cylinder.

SGCD

SGCJ

Bore size\Item	A		AB	AC	DA	DB	E	FA
	SGCD	SGCJ						
125	398	366.5	119	160	74	42.5	M27X2.0	13.5
160	484	458	152	180	94	68	M36X2.0	18
200	514	482	167	180	100	68	M36X2.0	18
250	578	547	189	200	111	80	M42X2.0	21

Remark:
 1. The dimensions of magnet type cylinder are the same as non-magnet type cylinder.
 2. The unmarked dimension is the same as SGC standard type.

ISO15552 Standard cylinder

SGC Series—Accessories

Dimensions

FA/FB

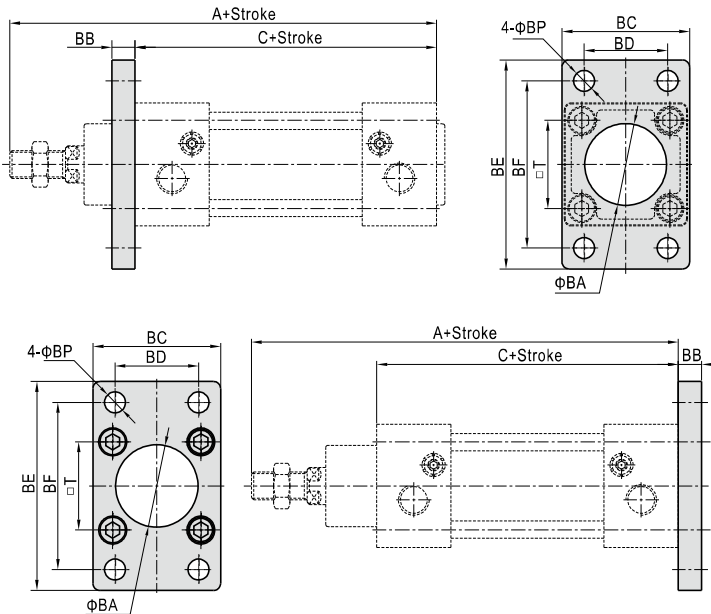

Bore size\Item	A	C	BA	BB	BC	BD	BE	BF	BP	T
125	279	160	60.5	20	139	90	218	180	16.5	110
160	332	180	65.5	20	180	115	280	230	18.5	140
200	347	180	75.5	25	220	135	320	270	24	175
250	389	200	90.5	25	267	165	376	330	26	220

CB

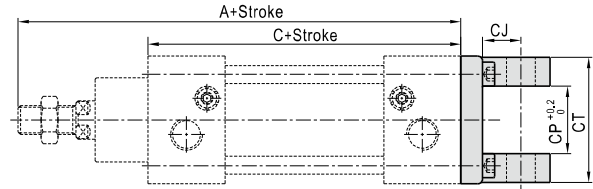
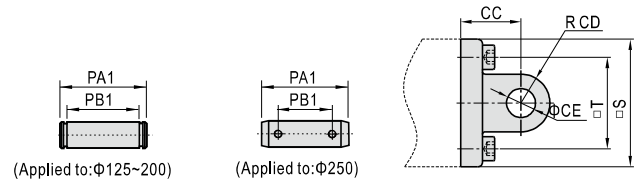

Bore size\Item	A	C	CC	CD	CE	CJ	CP	CT	PA1	PB1	S	T
125	279	160	50	21.5	25	31	70	130	139	130.5	139	110
160	332	180	55	30	30	35.5	90	170	181	170.5	180	140
200	347	180	60	30	30	36	90	170	181	170.5	220	175
250	389	200	70	35	40	46	110.3	200	230	208	270	220

TC

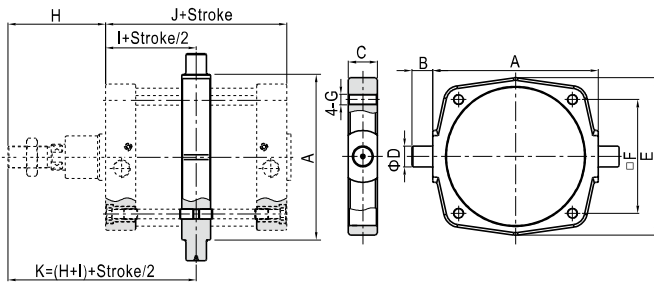

Bore size\Item	A	B	C	D	E	F	G	H	I	J	K
125	160	25	40	25	158.5	110	M12	119	80	160	199
160	200	32	46	32	197.5	140	M16	152	90	180	242
200	250	32	46	32	245	175	M16	167	90	180	257
250	320	40	56	40	304	220	M20	189	100	200	289

[Note] The installation position of the accessories can not be adjusted arbitrarily.

CR

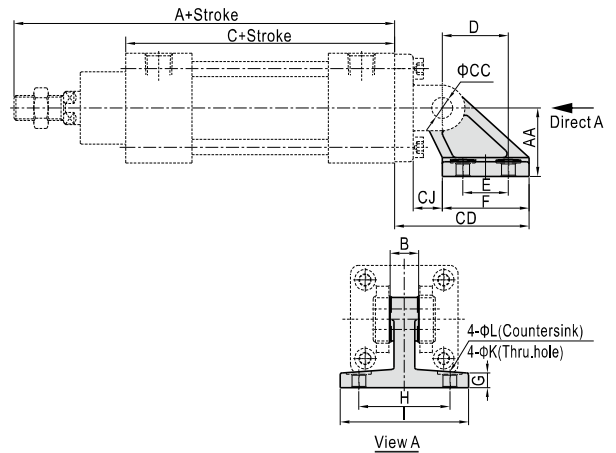

Bore size\Item	A	AA	B	C	CC	CD	CJ	D	E	F	G	H	I	K	L
125	279	90	70	160	25	135	26	70	60	90	20	94	124	14	20
160	332	115	90	180	30	171	25	97	88	126	25	118	156	14	20
200	347	135	90	180	30	185	31	105	90	130	30	122	162	18	26

[Note] CR can't be used alone, it must be used with CB.

ISO15552 Standard cylinder

SGC Series—Accessories

FTC

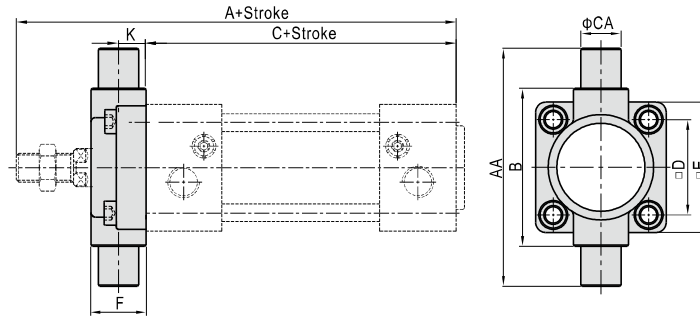

Bore size\Item	A	C	AA	B	CA	D	E	F	K
125	279	160	210	160	25	110	139	43	20
160	332	180	264	200	32	140	179	56	20
200	347	180	314	250	32	175	218	64	20

TCM1

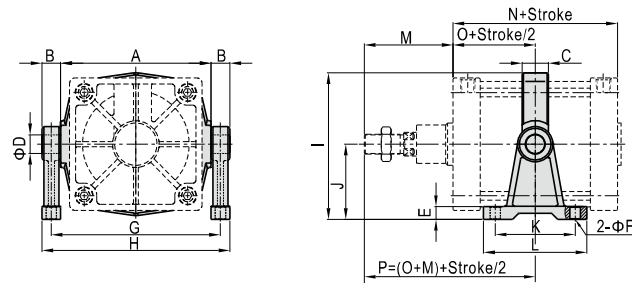

Bore size\Item	A	B	C	D	E	F	G	H	I	J	K	L	M	N	O	P
125	160	25	40	25	19	18	185	213	169.3	90	115	155	119	160	80	199
160	200	32	46	32	24	22	232	267	208.8	110	140	190	152	180	90	242
200	250	32	46	32	27	22	282	317	257.5	135	150	200	167	180	90	257
250	320	40	56	40	28	22	360	400	312	160	170	220	189	200	100	289

[Note] The installation position of the accessories can not be adjusted arbitrarily.

TCM2

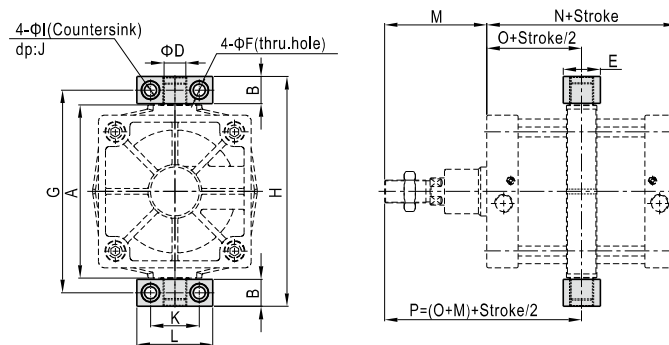

Bore size\Item	A	B	D	E	F	G	H	I	J	K	L	M	N	O	P
125	160	24.5	25	50	14	187.5	212	20	14	50	75	119	160	80	199
160	200	30	32	60	18	234	264	26	17.5	60	92	152	180	90	242
200	250	30	32	60	18	284	314	26	17.5	60	92	167	180	90	257
250	320	50	40	70	22	374	424	33	22	90	140	189	200	100	289

[Note] The installation position of the accessories can not be adjusted arbitrarily.