



Twin-rod cylinder——TN, TR Series

Compendium of TN/TR Series

TN series is enterprises standard, TR series is JIS standard

Bumper in front of the barrel

Bumper in front of the barrel can adjust the stroke of cylinder and relieve impact.

Twin-rod cylinder

It is good resistance to bending and twisting moments.

Be mounted the workpiece from three directions

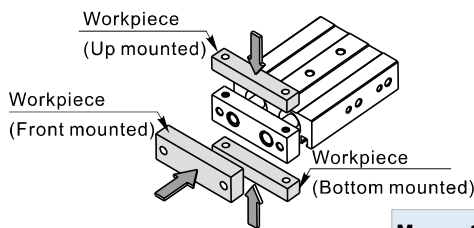

Magnetic switch slots around the cylinder body

There are magnetic switch slots around the cylinder body convenient to install inducting switch.

Multi-type cylinder

TN: Twin-rod cylinder (Double acting type)

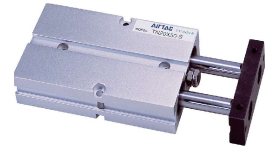

TR: Twin-rod cylinder (Double acting type)



Five or six bore size are available

TN series bore size: 10, 16, 20, 25, 32

TR series bore size: 6, 10, 16, 20, 25, 32

Mounted from four directions

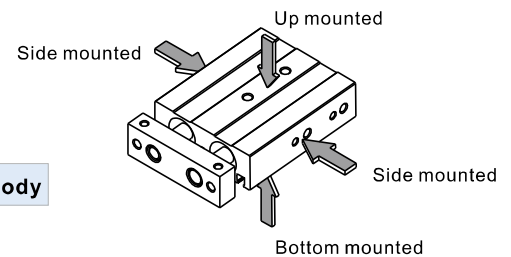

Criteria for selection: Cylinder thrust

Unit : Newton(N)

Bore size	Rod size	Acting type	Pressure area(mm ²)	Operating pressure(MPa)							
				0.1	0.2	0.3	0.4	0.5	0.6	0.7	
6	4	Double acting	Push side	56.5	5.7	11.3	17.0	22.6	28.3	33.9	39.6
			Pull side	31.4	3.1	6.3	9.4	12.6	15.7	18.8	22.0
10	6	Double acting	Push side	157.1	15.7	31.4	47.1	62.8	78.6	94.3	110.0
			Pull side	100.5	10.1	20.1	30.2	40.2	50.3	60.3	70.4
16	8	Double acting	Push side	402.1	40.2	80.4	120.6	160.8	201.1	241.3	281.5
			Pull side	301.6	30.2	60.3	90.5	120.6	150.8	181.0	211.1
20	10	Double acting	Push side	628.3	62.8	125.7	188.5	251.3	314.2	377.0	439.8
			Pull side	471.2	47.1	94.2	141.4	188.5	235.6	282.7	329.8
25	12	Double acting	Push side	981.7	98.2	196.4	294.5	392.7	490.9	589.0	687.2
			Pull side	755.6	75.6	151.1	226.7	302.2	377.8	453.4	528.9
32	16	Double acting	Push side	1608.5	160.9	321.7	482.6	643.4	804.3	965.1	1126.0
			Pull side	1206.4	120.6	241.3	361.9	482.6	603.2	723.8	844.5

Installation and application



- When load changes in the work, the cylinder with abundant output capacity shall be selected.
- Relative cylinder with high temperature resistance or corrosion resistance shall be chosen under the condition of high temperature or corrosion;
- Necessary protection measure shall be taken in the environment with higher humidity, much dust or water drops, oil dust and welding dregs.
- Dirty substances in the pipe must be eliminated before cylinder is connected with pipeline to prevent the entrance of particles into the cylinder;
- The medium used by cylinder shall be filtered to 40μm or below.
- As both the front cover and piston are short, too large stroke can not be selected.
- Anti-freezing measure shall be adopted under low temperature environment to prevent moisture freezing.
- The cylinder shall avoid radial load in operation to maintain the normal and extend service life.
- If the cylinder is dismantled and stored for a long time, please conduct anti-rust treatment to the surface. Anti-dust cap shall be inserted into the inlet and outlet ports. As the precision of the manufacture and guide is high, Please do not dismantle the fixed block or cylinder cover .



Twin-rod cylinder

TN Series

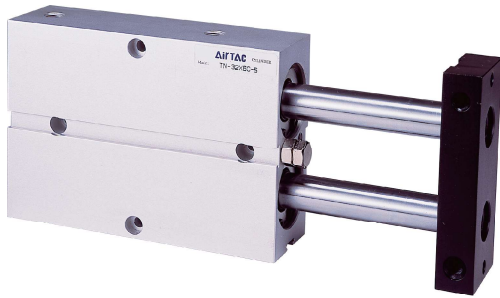

Symbol

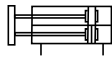

Specification

Bore size(mm)	10	16	20	25	32
Acting type	Double acting				
Fluid	Air(to be filtered by 40µm filter element)				
Operating pressure	0.2~1.0MPa(29~145psi)		0.15~1.0MPa(22~145psi)		
Proof pressure	1.5MPa(215psi)				
Temperature °C	-20~70				
Speed range mm/s	30~500				
Adjustable stroke mm	-5~0				
Stroke tolerance	≤100 ^{+1.0} ₀ >100 ^{+1.5} ₀				
Cushion type	Bumper				
Non-rotating tolerance [Note1]	±0.4°		±0.3°		
Port size [Note2]	M5×0.8				1/8"

[Note1] Retract position.

[Note2]PT thread is available.

Add) Refer to P362 for detail of sensor switch.

Product feature

1. Enterprises standard is implemented.
2. Embedded installation and fixation mode saves the installation space.
3. It is good resistance to bending and twisting moments.
4. Mounting holes on three sides facilitates multi-position mounting.
5. Bumper in front of the barrel can adjust the stroke of cylinder and relieve impact.
6. Standard configuration of this series has magnet and the type without magnet is not available.

Stroke

Bore size (mm)	Standard stroke (mm)													Max.std stroke	
10	10	20	30	40	50	60	70	80	90	100					100
16	10	20	30	40	50	60	70	80	90	100	125	150	175	200	200
20	10	20	30	40	50	60	70	80	90	100	125	150	175	200	200
25	10	20	30	40	50	60	70	80	90	100	125	150	175	200	200
32	10	20	30	40	50	60	70	80	90	100	125	150	175	200	200

[Note] When the stroke less then or equal to 100mm, The dimensions of non-std stroke cylinder has the same dimensions as the next longer stroke std. stroke cylinder. e.g. 35mm stroke cylinder has the same dimensions of 40 std. stroke cylinder.

Ordering code

TN 20 ×50 S □



① Model	② Bore size	③ Stroke	④ Magnet [Note1]	⑤ Thread type [Note 2]
TN: Twin-rod cylinder (Double acting type)	10 16 20 25 32	Refer to stroke table for details	S: With magnet	Blank: PT

[Note1] TN Series are all with magnet. [Note2] When the thread is standard, the code is blank.

Inner structure and material of major parts

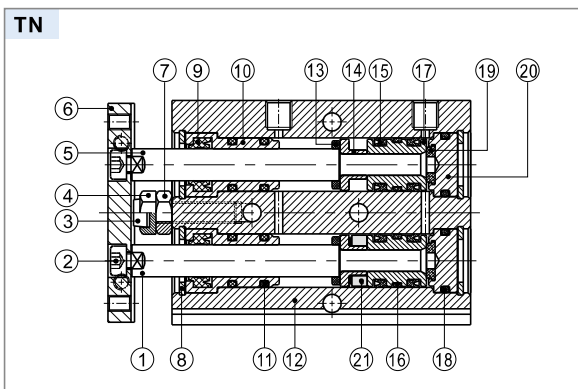

NO.	Item	Material	NO.	Item	Material
1	Piston rod B	Φ32 S45C Other SUS304	12	Body	Aluminum alloy
2	Screw	Carbon steel	13	Bumper	TPU
3	Bumper	POM	14	Magnet holder	Φ10 SUS303 Other Aluminum alloy
4	Adjustable nut	Carbon steel	15	Piston seal	NBR
5	Piston rod A	S45C	16	Wear ring	Wear resistant material
6	Fixing plate	Free cutting steel	17	Piston	Φ10 SUS303 Other Aluminum alloy
7	Screw	Carbon steel	18	Seal ring	NBR
8	C clip	Spring steel	19	Bumper	TPU
9	Wiper seal	NBR	20	Back cover	Aluminum alloy
10	Front cover	Aluminum alloy	21	Magnet	Sintered metal(Neodymium-iron-boron)
11	O-ring	NBR			

Twin-rod cylinder

TN Series

Dimensions

TN10

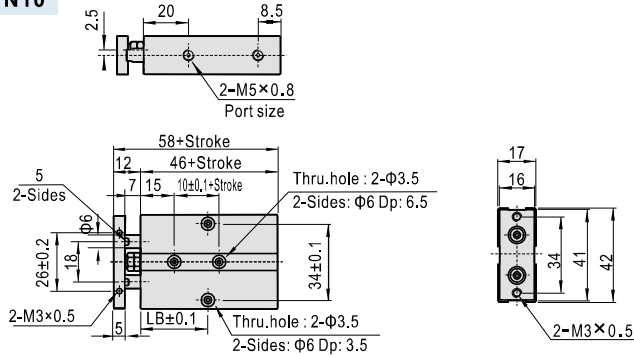

Item\Stroke	10	20	30	40	50	60	70	80	90	100
LB	30	30	35	40	45	50	55	60	65	70

TN16~25

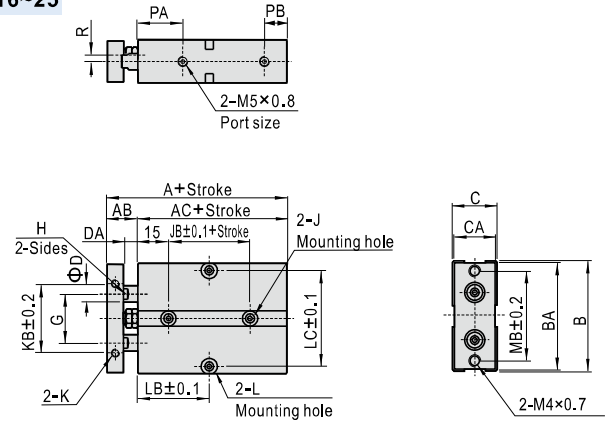

Bore size\Item	A	AB	AC	B	BA	C	CAD	DA	G	H	J
16	68	15	53	54	53	21	20	8	8.2	24	6
20	78	20	58	62	61	25	24	10	10.2	28	8
25	81	19	62	73	72	30	29	12	10.2	34	10

Bore size\Item	JB	K	KB	PA	PB	L	LC	MB	R
16	20	M4x0.7Dp:5	34	22	11	Both sides:Φ8Dp:4.5Thru.hole:Φ4.5	47	47	3
20	20	M4x0.7Dp:5	44	25	12	Both sides:Φ8Dp:4.5Thru.hole:Φ4.5	55	55	3.5
25	30	M4x0.7Dp:6	56	27	12	Both sides:Φ8Dp:4.5Thru.hole:Φ4.5	66	66	6

Bore size\Item	LB															
Stroke≤	10	20	30	40	50	60	70	80	90	100	125	150	175	200		
16	30	35	40	45	50	55	60	65	70	75	87.5	100	112.5	125		
20	35	35	40	45	50	55	60	65	70	75	87.5	100	112.5	125		
25	40	40	45	50	55	60	65	70	75	80	92.5	105	117.5	130		

TN32

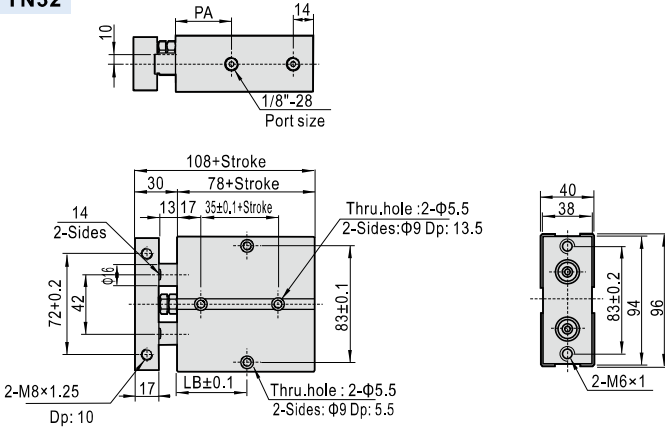

Item\Stroke	10	20	30	40	50	60	70	80	90	100	125	150	175	200
LB	45	50	55	60	65	70	75	80	85	90	102.5	115	127.5	140
PA	35	40												

Installation and application

1、How to mount workpiece :

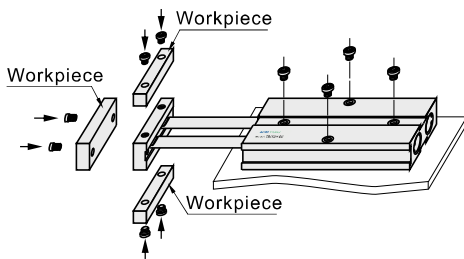

2、Max. weight of allowable side-load

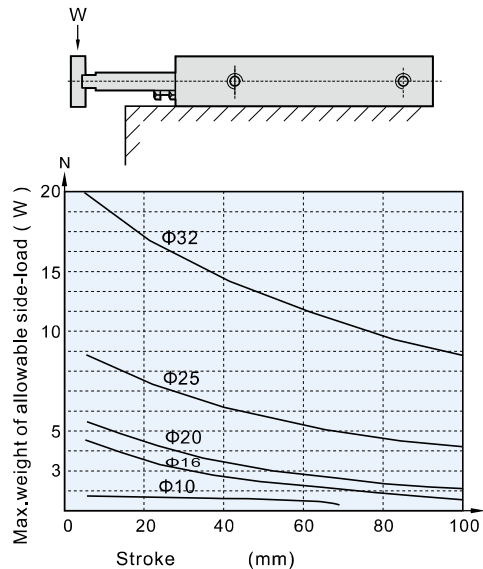

Twin-rod cylinder

TR Series



Symbol

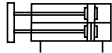

Product feature

1. JIS standard is implemented.
2. The non-rotating precision is high and deflection of the end of piston rod is low, which is suitable for precise guide.
3. It adopts lengthening type sliding supporting guide. No additional lubricant is needed and it has good performance of guide.
4. Mounting holes on three sides facilitates multi-position mounting.
5. It is good resistance to bending and twisting moments.
6. Except for the axial, each side of the cylinder has installation orifices to provide several installation and fixation ways for the customers.
7. There are two groups of air intake and outlet at two sides of the cylinder for the actual selection.
8. Bumper in front of the barrel can adjust the stroke of cylinder and relieve impact.
9. Standard configuration of this series has magnet and the type without magnet is not available.

Specification

Bore size(mm)	6	10	16	20	25	32
Acting type	Double acting					
Fluid	Air(to be filtered by 40μm filter element)					
Operating pressure	0.2~1.0MPa(29~145psi)			0.15~1.0MPa(22~145psi)		
Proof pressure	1.5MPa(215psi)					
Temperature °C	-20~70					
Speed range mm/s	30~500					
Adjustable stroke mm	-5~0					
Stroke tolerance	≤100 ^{+1.0} ₀ > 100 ^{+1.5} ₀					
Cushion type	Bumper					
Non-rotating tolerance [Note1]	±0.2°	±0.15°			±0.1°	
Port size [Note2]	M5×0.8				1/8"	

[Note1] Retract position.

[Note2]PT thread, G thread and NPT thread are available.

Add) Refer to P362 for detail of sensor switch.

Stroke

Bore size (mm)	Standard stroke (mm)															Max.std stroke
6	10	20	30	40	50											50
10	10	20	30	40	50	60	70	80	90	100						100
16	10	20	30	40	50	60	70	80	90	100	125	150	175	200	200	
20	10	20	30	40	50	60	70	80	90	100	125	150	175	200	200	
25	10	20	30	40	50	60	70	80	90	100	125	150	175	200	200	
32	10	20	30	40	50	60	70	80	90	100	125	150	175	200	200	

[Note] When the stroke less then or equal to 100mm, The dimensions of non-std stroke cylinder has the same dimensions as the next longer stroke std. stroke cylinder, e.g. 35mm stroke cylinder has the same dimensions of 40 std. stroke cylinder.

Ordering code

TR 20 ×50 S □



① Model	② Bore size	③ Stroke	④ Magnet [Note1]	⑤ Thread type [Note 2]
TR: Twin-rod cylinder (Double acting type)	6 10 16 20 25 32	Refer to stroke table for details	S: With magnet	Blank: PT G : G T : NPT

[Note1] TR Series are all with magnet. [Note2] When the thread is standard, the code is blank.

Inner structure and material of major parts

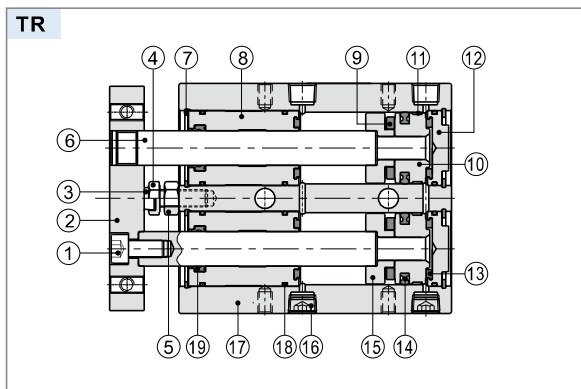

NO.	Item	Material	NO.	Item	Material
1	Screw	Carbon steel	10	Piston	Φ6,10 SUS304
2	Fixing plate	Aluminum alloy			Other Aluminum alloy
3	Bumper	POM	11	Wear ring	Nylon 6
4	Screw	Free cutting steel	12	Back cover	Aluminum alloy
5	Nut	Carbon steel	13	Bumper	TPU
6	Piston rod	Φ20~32	14	Piston seal	NBR
		Other			SUS304
7	C clip	Spring steel	15	Magnet holder	Φ6,10 SUS304
8	Front cover	Aluminum alloy			Other Aluminum alloy
9	Magnet	Φ32	16	Screw	Carbon steel
		Other	17	Body	Aluminum alloy
			18	Back cover O-ring	NBR
		Sintered metal (Neodymium-iron-boron)	19	Spool O-ring	NBR

Twin-rod cylinder

TR Series

Dimensions

TR6~16

Bore size\Item	A	AB	AC	B	BA	C	CA	D	DA	G	T	NB	PA	PB	R	S
6	58,5	13,5	45	37	35	16	14	4	8	16	23	28	24,5	6,5	M3×0,5	4,5
10	72	17	55	46	44	17	15	6	9	20	36,5	35	30	8	M4×0,7	3,5
16	79	19	60	58	56	20	18	8	9	25	46,5	45	38	8	M5×0,8	5

Bore size\Item	JC LC							
Stroke	10~25	30~50	60~80	90~100	125	150	175	200
6	JC=10+Stroke/2 LC=13+Stroke		-	-	-	-	-	-
10	30	40	50	60	-	-	-	-
16	25	35	45	55	65	75	145	145

Bore size\Item	J	JB	K
6	One side:φ6.5Dp:3.5Thru.hole:φ3.5	13	-
10	One side:φ6.5Dp:3.5Thru.hole:φ3.5	20	M4×0.7Thru.thread
16	One side:φ8.0Dp:4.5Thru.hole:φ4.5	30	M5×0.8Thru.thread

Bore size\Item	L	LB	M
6	M3×0.5Dp:4.5	10	M3×0.5
10	M3×0.5Dp:5	20	M5×0.8
16	M4×0.7Dp:5	30	M6×1.0

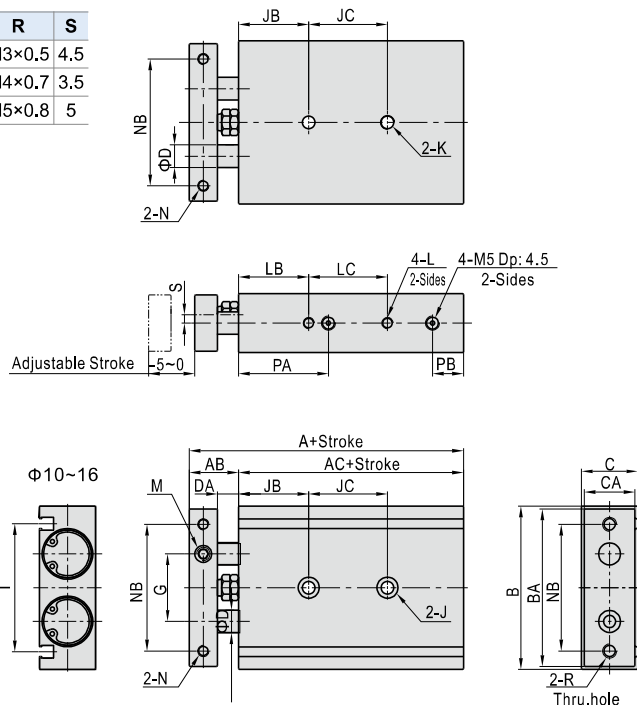
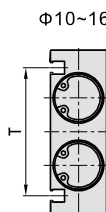
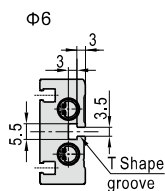

TR20~32

Bore size\Item	A	AB	AC	B	BA	C	CA	D	DA	G	JB	P	PA	PB
20	94	24	70	64	62	25	23	10	12	28	30	M5×0,8	46	9
25	96	24	72	80	78	30	28	12	12	35	30	1/8"	43	9
32	112	30	82	98	96	38	36	16	14	44	30	1/8"	53	10

Bore size\Item	JC LB							
Stroke	10~25	30~50	60~100	125	150	175	200	
20	30	40	60	80	80	100	100	
25	30	40	60	80	80	100	100	
32	40	50	70	90	90	110	110	

Bore size\Item	K	J	L
20	M6×1.0	One side:φ9.5Dp:5.5Thru.hole:φ5.5	M4×0.7Dp:5.5
25	M8×1.25	One side:φ11Dp:6.5Thru.hole:φ7	M5×0.8Dp:7
32	M8×1.25	One side:φ11Dp:6.5Thru.hole:φ7	M5×0.8Dp:7

Bore size\Item	LC	M	N	NB	R	S	T
20	9,5	M8×1,25	M4×0,7Dp:6	50	M5×0,8	6,5	52
25	13	M8×1,25	M5×0,8Dp:7,5	60	M6×1,0	9	61
32	20	M10×1,5	M5×0,8Dp:8	75	M6×1,0	11,5	73

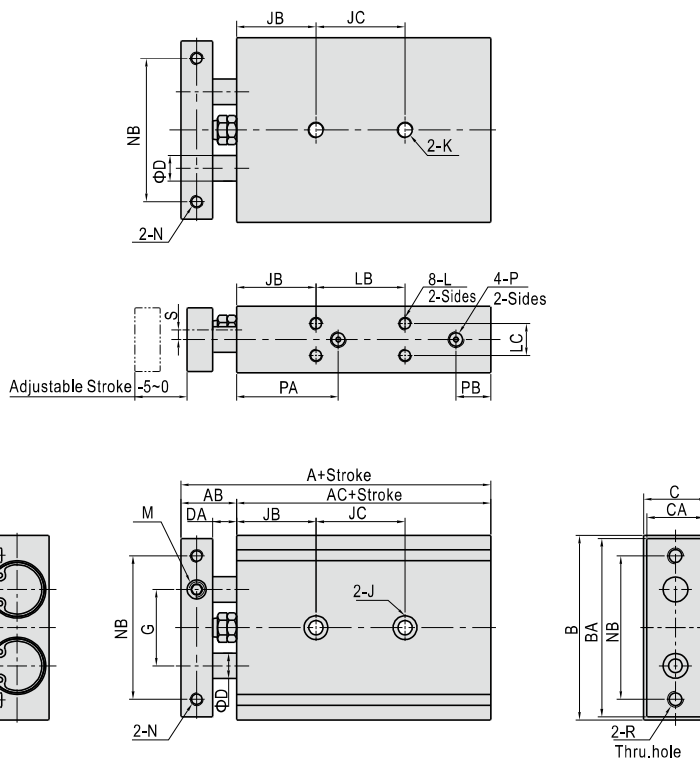
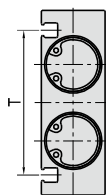

Installation and application

1、 How to mount workpiece :

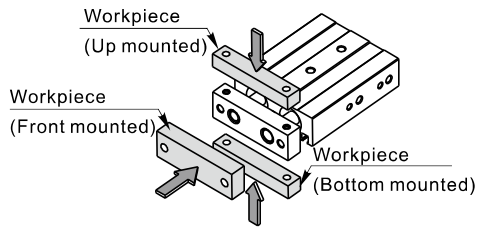

How to mount the workpiece

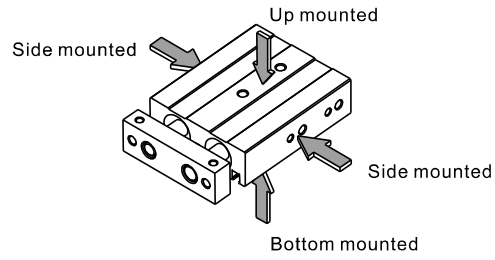

How to mount the cylinder

2、 Max. weight of allowable side-load

Mounting type

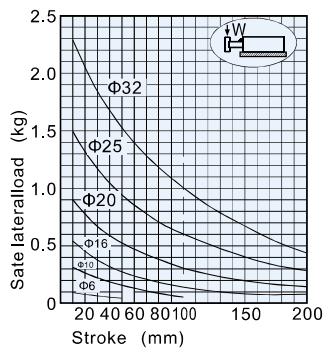
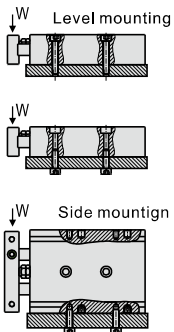

3、 Safe deflection

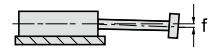
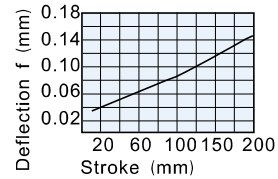

The average value of deflection of rod end of the whole series basically stays in the line showed in the chart on the right.