

# Air Cylinder Short Type

## Standard: Double Acting, Single Rod

# CM3 Series

ø20, ø25, ø32, ø40



### How to Order

**With auto switch**

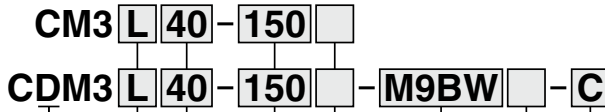

B	Basic
L	Foot
F	Rod flange
G	Head flange
C	Single clevis
D	Double clevis
U	Rod trunnion

**Mounting**

T	Head trunnion
E	Integrated clevis
BZ	Boss-cut/Basic
FZ	Boss-cut/Rod flange
UZ	Boss-cut/Rod trunnion

**Bore size**

20	20 mm
25	25 mm
32	32 mm
40	40 mm

**Rod end thread**

Nil	Male thread
F	Female thread
G	Long male rod end*

\* G: Same rod end dimensions (A, AL, H) as CM2 series.

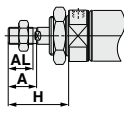

**Auto switch mounting bracket** (Note)  
 Note) This symbol is indicated when the D-A9□ or M9□ type auto switch is specified. This mounting bracket does not apply to other auto switches (D-C7□ and H7□, etc.) (Nil)

**Number of auto switches**

Nil	2 pcs.
S	1 pc.
n	"n" pcs.

**Auto switch**

Nil	Without auto switch
-----	---------------------

### Built-in Magnet Cylinder Model

If a built-in magnet cylinder without an auto switch is required, there is no need to enter the symbol for the auto switch.  
 (Example) CDM3F32-100

**Cylinder stroke (mm)**  
 Refer to the next page for standard strokes.

### Applicable Auto Switches

Refer to pages 1575 to 1701 for further information on auto switches.

Type	Special function	Electrical entry	Indicator light	Wiring (Output)	Load voltage		Auto switch model		Lead wire length (m)					Pre-wired connector	Applicable load			
					DC	AC	Perpendicular	In-line	0.5 (Nil)	1 (M)	3 (L)	5 (Z)	None (N)					
Solid state auto switch	—	Grommet	No	3-wire (NPN)	5 V, 12 V	—	M9NV	M9N	●	●	●	○	—	○	IC circuit			
				3-wire (PNP)			M9PV	M9P	●	●	●	○	—	○				
		Connector	Yes	2-wire	5 V, 12 V	—	M9BV	M9B	●	●	●	○	—	○	—			
				Terminal conduit			3-wire (NPN)	—	H7C	●	—	●	○	—		○	IC circuit	
	Diagnostic indication (2-color indicator)	Grommet	Yes	2-wire	5 V, 12 V	—	M9WV	M9NW	●	●	●	○	—	○	—			
				3-wire (PNP)			M9WV	M9W	●	●	●	○	—	○				
				Water resistant (2-color indicator)	Grommet	Yes	2-wire	5 V, 12 V	—	M9NAV*1	M9NA*1	○	○	●	○	—	○	—
							3-wire (PNP)			M9PAV*1	M9PA*1	○	○	●	○	—	○	
				Diagnostic output (2-color indicator)	Grommet	Yes	2-wire	5 V, 12 V	—	M9BAV*1	M9BA*1	○	○	○	○	—	○	—
							4-wire (NPN)			—	H7NF	●	—	●	○	—	○	
Reed auto switch	—	Grommet	Yes	3-wire (Equiv. to NPN)	—	5 V	—	A96V	A96	●	—	●	—	—	IC circuit	—		
				Connector	No	2-wire	24 V	12 V	100 V	A93V*2	A93	●	●	●	—	—	—	—
									100 V or less	A90V	A90	●	—	●	—	—	—	
									100 V, 200 V	—	B54	●	—	●	—	—	—	
									200 V or less	—	B64	●	—	●	—	—	—	
		Terminal conduit	No	2-wire	24 V	12 V	24 V or less	—	C73C	●	—	●	●	—	—	IC circuit		
							—	—	C80C	●	—	●	●	—	—			
							—	—	A33A	—	—	—	—	●	—	PLC		
							—	—	A34A	—	—	—	—	●	—			
							100 V, 200 V	—	A44A	—	—	—	—	●	—			
DIN terminal	Yes	2-wire	24 V	12 V	—	—	A44A	—	—	—	—	—	—	—				
					—	—	B59W	●	—	●	—	—	—					
					—	—	—	—	—	—	—	—	—					
					—	—	—	—	—	—	—	—	—					
					—	—	—	—	—	—	—	—	—					

\*1 Water resistant type auto switches can be mounted on the above models, but in such case SMC cannot guarantee water resistance.  
 A water-resistant type cylinder is recommended for use in an environment which requires water resistance.  
 \*2 1 m type lead wire is only applicable to D-A93.  
 \* Lead wire length symbols: 0.5 m ..... Nil (Example) M9NW  
 1 m ..... M (Example) M9NWM  
 3 m ..... L (Example) M9NWL  
 5 m ..... Z (Example) M9NZ  
 None ..... N (Example) H7CN  
 \* Solid state auto switches marked with "○" are produced upon receipt of order.  
 \* Do not indicate suffix "N" for no lead wire on the D-A3□/A44/A/G39A/K39A types.  
 \* The D-G39A/K39A cannot be mounted on the bore size ø20.  
 \* Since there are other applicable auto switches than listed above, refer to page 286 for details.  
 \* For details about auto switches with pre-wired connector, refer to pages 1648 and 1649.  
 \* The D-A9□(V), M9□(V), M9□W(V), M9□A(V) type auto switches are shipped together, (but not assembled). (However, auto switch mounting brackets are assembled when being shipped.)



CJ1
CJP
CJ2
JCM
CM2
CM3
CG1
CG3
JMB
MB
MB1
CA2
CS1
CS2
D-□
-X□
Technical Data



## Symbol

Double acting,  
Single rod/Rubber bumper

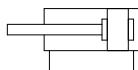

Refer to pages 283 to 286 for cylinders with auto switches.

- Auto switch proper mounting position (detection at stroke end) and its mounting height
- Minimum stroke for auto switch mounting
- Operating range
- Auto switch mounting brackets/Part no.

## Warning

1. Operate the cylinder within the specified cylinder speed, kinetic energy and lateral load at the rod end.
2. The allowable kinetic energy is different between the cylinders with male rod end and with female rod end due to the different thread sizes. Refer to page 274.
3. When female rod end is used, use a washer, etc. to prevent the contact part at the rod end from being deformed depending on the material of the work piece.

## Caution

1. Use a thin wrench when tightening the piston rod.

## Specifications

Bore size (mm)		20	25	32	40
Type	Pneumatic				
Action	Double acting, Single rod				
Fluid	Air				
Proof pressure	1.0 MPa				
Maximum operating pressure	0.7 MPa				
Minimum operating pressure	0.05 MPa				
Ambient and fluid temperature	Without auto switch: -10 to +70°C (No freezing) With auto switch: -10 to +60°C (No freezing)				
Lubrication	Not required (Non-lube)				
Stroke length tolerance	$^{+1.4}_0$ mm				
Piston speed	50 to 750 mm/s				
Cushion	Rubber bumper				
Allowable kinetic energy	Male rod end	0.2 J	0.29 J	0.46 J	0.84 J
	Female rod end	0.11 J	0.18 J	0.29 J	0.52 J

\* Operate the cylinder within the allowable kinetic energy. Refer to page 274 for details.

## Standard Strokes

Bore size (mm)	Standard stroke (mm) <sup>Note)</sup>
20	25, 50, 75, 100, 125, 150, 200, 250, 300
25	
32	
40	

\* Other intermediate strokes can be manufactured upon receipt of order.  
Manufacture of intermediate strokes in 1 mm increments is possible. (Spacers are not used.)

## Boss-cut

Boss for the head cover bracket is eliminated and the total length of cylinder is shortened.



## Comparison of the Full Length Dimension (Versus CM3□-□ type)

	ø20	ø25	ø32	ø40
	-13	-13	-13	-16

## Mounting

- Boss-cut/Basic (BZ)
- Boss-cut/Rod flange (FZ)
- Boss-cut/Rod trunnion (UZ)

## Mounting Brackets/Part No.

Mounting bracket	Min. order qty.	Bore size (mm)				Contents (for minimum order quantity)
		20	25	32	40	
Foot *	2	CM-L020B	CM-L032B	CM-L040B	CM-L040B	2 feet, 1 mounting nut
Flange	1	CM-F020B	CM-F032B	CM-F040B	CM-F040B	1 flange
Single clevis **	1	CM-C020B	CM-C032B	CM-C040B	CM-C040B	1 single clevis, 3 liners
Double clevis *** (with pin)	1	CM-D020B	CM-D032B	CM-D040B	CM-D040B	1 double clevis, 3 liners, 1 clevis pin, 2 retaining rings
Trunnion (with nut)	1	CM3-T020B	CM3-T032B	CM3-T040B	CM3-T040B	1 trunnion, 1 trunnion nut

\* Order 2 feet per cylinder.

\*\* 3 liners are included with a clevis bracket for adjusting the mounting angle.

\*\*\* A clevis pin and retaining rings (split pins for ø40) are included.

## Mounting and Accessories

Accessories	Standard			Option		
	Mounting nut	Rod end nut (male thread)	Clevis pin	Single knuckle joint	Double knuckle joint <small>Note 3)</small>	Pivoting clevis bracket <small>Note 4)</small>
Basic	● (1 pc.)	●	—	●	●	—
Foot	● (2)	●	—	●	●	—
Rod flange	● (1)	●	—	●	●	—
Head flange	● (1)	●	—	●	●	—
Integrated clevis	— <small>Note 1)</small>	●	—	●	●	●
Single clevis	— <small>Note 1)</small>	●	—	●	●	—
Double clevis <small>Note 3)</small>	— <small>Note 1)</small>	●	● <small>Note 5)</small>	●	●	—
Rod trunnion	● (1) <small>Note 2)</small>	●	—	●	●	—
Head trunnion	● (1) <small>Note 2)</small>	●	—	●	●	—
Boss-cut/Basic	● (1)	●	—	●	●	—
Boss-cut/Rod flange	● (1)	●	—	●	●	—
Boss-cut/Rod trunnion	● (1)	●	—	●	●	—

Note 1) Mounting nuts are not attached to the Integrated clevis, single clevis and double clevis types.

Note 2) Trunnion nuts are attached to the rod trunnion and head trunnion types.

Note 3) A pin and retaining rings (split pins for ø40) are included with the double clevis and double knuckle joint.

Note 4) A pivoting clevis bracket pin and retaining rings are included with the pivoting clevis bracket.

Note 5) Retaining rings (split pins for ø40) are included with the clevis pin.

## Mounting Brackets, Accessories/Material, Surface Treatment

Segment	Description	Material	Surface treatment
Mounting brackets	Foot	Iron	Nickel plated
	Flange	Iron	Nickel plated
	Single clevis	Iron	Nickel plated
	Double clevis	Iron	Nickel plated
	Trunnion	Iron	Electroless nickel plated
Accessories	Rod end nut (male thread)	Iron	Zinc chromated
	Mounting nut	Iron	Nickel plated
	Trunnion nut	Iron	Nickel plated
	Pivoting clevis bracket	Iron	Nickel plated
	Pivoting clevis bracket pin	Iron	(None)
	Single knuckle joint	Iron	Electroless nickel plated
	Double knuckle joint	Iron	Electroless nickel plated Metallic silver color painted for ø40
	Double clevis pin	Iron	(None)
	Double knuckle joint pin	Iron	(None)

\* For part numbers and dimensions of accessories, refer to pages 280 and 281.

## Weights

Bore size (mm)		20	25	32	40
Basic weight	Basic	0.12	0.18	0.25	0.45
	Long male rod end (G)	0.13	0.20	0.27	0.48
	Female rod end (F)	0.11	0.17	0.23	0.41
	Boss-cut/Basic	0.11	0.17	0.23	0.42
	Boss-cut/Long male rod end	0.12	0.18	0.25	0.45
	Boss-cut/Female rod end	0.10	0.15	0.22	0.38
	Integrated clevis	0.12	0.18	0.26	0.46
	Integrated clevis/Long male rod end	0.13	0.19	0.28	0.48
	Integrated clevis/Female rod end	0.11	0.16	0.25	0.41
	Foot	0.15	0.16	0.16	0.27
Additional weight for bracket	Flange	0.06	0.09	0.09	0.12
	Single clevis	0.04	0.04	0.04	0.09
	Double clevis	0.05	0.06	0.06	0.13
	Trunnion	0.04	0.07	0.07	0.10
Pivoting bracket	0.08	0.09	0.17	0.25	
Single knuckle joint	0.05	0.09	0.09	0.10	
Double knuckle joint (with pin)	0.05	0.09	0.09	0.13	
Additional weight per 50 mm of stroke	0.04	0.06	0.08	0.11	
Additional weight for switch magnet	0.01	0.01	0.01	0.01	

## Warning

### 1. Do not rotate the cover.

If a cover is rotated when installing a cylinder or screwing a fitting into the port, it is likely to damage the junction part with cover.

## Caution

### 1. Do not touch the cylinder during operation at a high speed and a high frequency.

Use caution when handling a cylinder, which is running at a high speed and a high frequency, because the surface of a cylinder tube could get so hot enough as to cause you get burned.

### 2. Do not use the air cylinder as an air-hydro cylinder.

If it uses turbine oil in place of fluids for cylinder, it will result in oil leakage and damage the product.

Calculation: (Example) **CDM3F20-100G**

(Flange type, ø20, 100 mm stroke)

- Basic weight ..... 0.13 (Basic type G, ø20)
- Additional weight for bracket ..... 0.06 (Flange)
- Additional weight for stroke ..... 0.04/50 mm
- Air cylinder stroke ..... 100 mm
- Additional weight for switch magnet ..... 0.01

$$0.13 + 0.06 + 0.04 \times (100/50) + 0.01 = 0.28 \text{ kg}$$

# CM3 Series

## Allowable Kinetic Energy

**Table (1) Max. Allowable Kinetic Energy** [J]

Bore size (mm)	20	25	32	40
Male rod end	0.2	0.29	0.46	0.84
Female rod end	0.11	0.18	0.29	0.52

$$\text{Kinetic energy } E \text{ (J)} = \frac{(m_1 + m_2) V^2}{2}$$

$m_1$  : Mass of cylinder movable parts    kg  
 $m_2$  : Load mass    kg  
 $V$  : Piston speed at the end    m/s

**Table (2) Mass of Cylinder Movable Parts: At Each Rod End/Without Built-in Magnet/0 Stroke** [g]

Bore size (mm)	20	25	32	40
Basic	31.2	55.8	82.5	147.3
Long male rod end (G)	39.4	69.4	102.0	172.7
Female rod end (F)	22.4	38.5	66.5	102.3

\* Mass of the rod end nut is included for the basic type and the long male rod end type (G).

**Table (3) Additional Mass** [g]

Bore size (mm)	20	25	32	40
Additional mass per 50 mm of stroke	19.6	30.6	44.1	60.6
Switch magnet	3.5	4.0	5.0	6.0

\* Do not apply a lateral load over the allowable range to the rod end when it is mounted horizontally.

Calculation: (Example) CDM3B40-175

- Basic mass of movable parts: Table (2) Rod end [Basic, Bore size [40] ..... 147.3 g
  - Additional mass: Additional mass of stroke 60.6 x 175/50 = 212.1 g ..... 212.1 g
  - Switch magnet ..... 6.0 g
- Total 365.4 g

## Allowable Lateral Load at Rod End

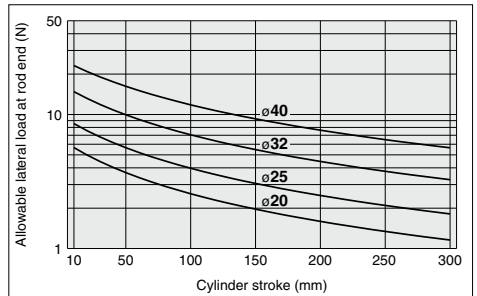

## Theoretical Output

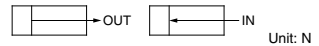

Bore size D (mm)	Rod size d (mm)	Operating direction	Piston area (mm <sup>2</sup> )	Operating pressure (MPa)						
				0.2	0.3	0.4	0.5	0.6	0.7	
20	8	OUT	314	62.8	94.2	125.6	157	188.4	219.8	
		IN	264	52.8	79.2	105.6	132	158.4	184.8	
25	10	OUT	491	98.2	147.3	196.4	245.5	294.6	343.7	
		IN	412	82.4	123.6	164.8	206	247.2	288.4	
32	12	OUT	804	160.8	241.2	321.6	402	482.4	562.8	
		IN	691	138.2	207.3	276.4	345.5	414.6	483.7	
40	14	OUT	1257	251.4	377.1	502.8	628.5	754.2	879.9	
		IN	1103	220.6	330.9	441.2	551.5	661.8	772.1	

\* Theoretical output (N) = Pressure (MPa) x Piston area (mm<sup>2</sup>)

## Construction

### With rubber bumper

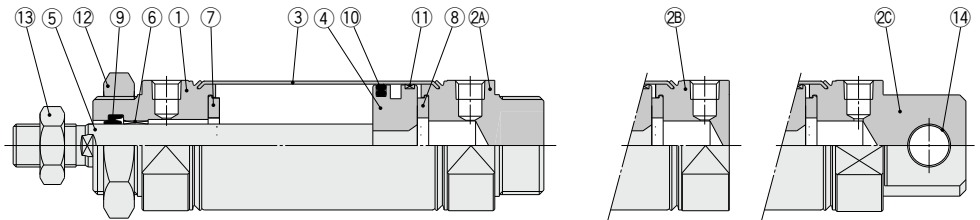

### Component Parts

No.	Description	Material	Note
1	Rod cover	Aluminum alloy	Anodized
2A	Head cover A	Aluminum alloy	Anodized
2B	Head cover B	Aluminum alloy	Anodized
2C	Head cover C	Aluminum alloy	Anodized
3	Cylinder tube	Stainless steel	
4	Piston	Aluminum alloy	Chromated
5	Piston rod	Carbon steel	Hard chrome plated
6	Bushing	Bearing alloy	
7	Bumper A	Urethane	
8	Bumper B	Urethane	
9	Rod seal	NBR	
10	Piston seal	NBR	
11	Wear ring	Resin	
12	Mounting nut	Carbon steel	Nickel plated
13	Rod end nut	Carbon steel	Zinc chromated
14	Bushing for clevis	Bearing alloy	

## ⚠ Caution

### 1. Not able to disassemble.

Cover and cylinder tube are connected to each other by crimping method, thus making it impossible to disassemble.

## Dimensions

### Basic (B): C□M3B Bore size - Stroke

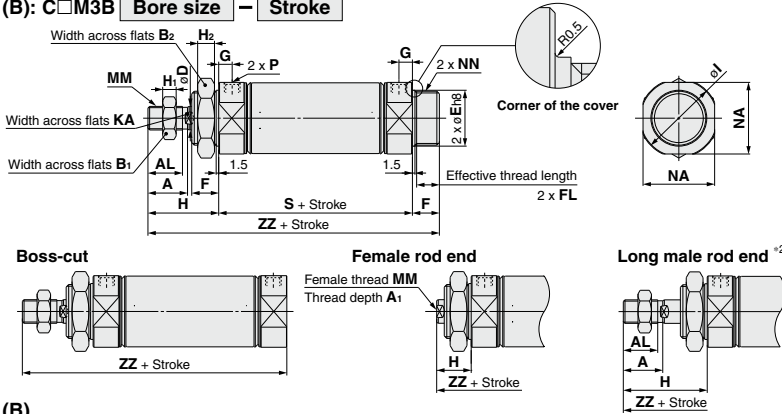

### Basic (B)

Bore size	A	AL	B <sub>1</sub>	B <sub>2</sub>	D	E	F	FL	G	H	H <sub>1</sub>	H <sub>2</sub>	I	KA	MM	NA	NN
20	14.5	12	13	26	8	20 <sup>0</sup> <sub>-0.033</sub>	13	10.5	6	31	5	8	27.9	Width across flats 6 length 3.5	M8 x 1.25	24	M20 x 1.5
25	17.5	15	17	32	10	26 <sup>0</sup> <sub>-0.033</sub>	13	10.5	6	34	6	8	33.4	Width across flats 8 length 3.5	M10 x 1.25	30	M26 x 1.5
32	17.5	15	17	32	12	26 <sup>0</sup> <sub>-0.033</sub>	13	10.5	8	34	6	8	37.4	Width across flats 10 length 3.5	M10 x 1.25	34.5	M26 x 1.5
40	23.5	20.5	22	41	14	32 <sup>0</sup> <sub>-0.039</sub>	16	13.5	8	42	8	10	46.4	Width across flats 12 length 3.5	M14 x 1.5	42.5	M32 x 2

Bore size	P	S	ZZ
20	M5 x 0.8	55	99
25	M5 x 0.8	56	103
32	Rc1/8	62	109
40	Rc1/8	67	125

Bore size	ZZ (mm)
20	86
25	90
32	96
40	109

Bore size	A <sub>1</sub>	H	MM	ZZ
20	8	20	M4 x 0.7	88
25	8	20	M5 x 0.8	89
32	12	20	M6 x 1	95
40	13	21	M8 x 1.25	104

Bore size	A	AL	H	ZZ
20	18	15.5	41	109
25	22	19.5	45	114
32	22	19.5	45	120
40	24	21	50	133

\*1 Use a thin wrench when tightening the piston rod.

\*2 The dimension from the rod cover to the male rod end of the long male rod end type is the same as the CM2 series.

\*3 When female thread is used, use a washer, etc. to prevent the contact part at the rod end from being deformed depending on the material of the work piece.

### Foot (L): C□M3L Bore size - Stroke

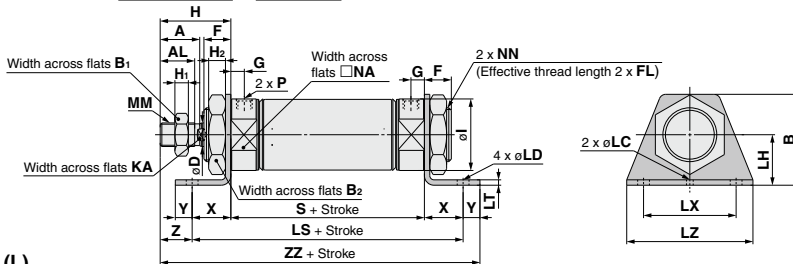

### Foot (L)

Bore size	A	AL	B	B <sub>1</sub>	B <sub>2</sub>	D	F	FL	G	H	H <sub>1</sub>	H <sub>2</sub>	I	KA	LC	LD	LH	LS
20	14.5	12	40	13	26	8	13	10.5	6	31	5	8	27.9	Width across flats 6 length 3.5	4	6.8	25	95
25	17.5	15	47	17	32	10	13	10.5	6	34	6	8	33.4	Width across flats 8 length 3.5	4	6.8	28	96
32	17.5	15	47	17	32	12	13	10.5	8	34	6	8	37.4	Width across flats 10 length 3.5	4	6.8	28	102
40	23.5	20.5	54	22	41	14	16	13.5	8	42	8	10	46.4	Width across flats 12 length 3.5	4	7	30	113

Bore size	LT	LX	LZ	MM	NA	NN	P	S	X	Y	Z	ZZ
20	3.2	40	55	M8 x 1.25	24	M20 x 1.5	M5 x 0.8	55	20	8	11	114
25	3.2	40	55	M10 x 1.25	30	M26 x 1.5	M5 x 0.8	56	20	8	14	118
32	3.2	40	55	M10 x 1.25	34.5	M26 x 1.5	Rc1/8	62	20	8	14	124
40	3.2	55	75	M14 x 1.5	42.5	M32 x 2	Rc1/8	67	23	10	19	142

\* Use a thin wrench when tightening the piston rod.

\* Refer to the dimensions of the basic type for the female rod end type and the long male rod end type.

CJ1

CJP

CJ2

JCM

CM2

**CM3**

CG1

CG3

JMB

MB

MB1

CA2

CS1

CS2

D-□

-X□

Technical Data

# CM3 Series

## Dimensions

Rod Flange (F): C□M3F **Bore size** – **Stroke**

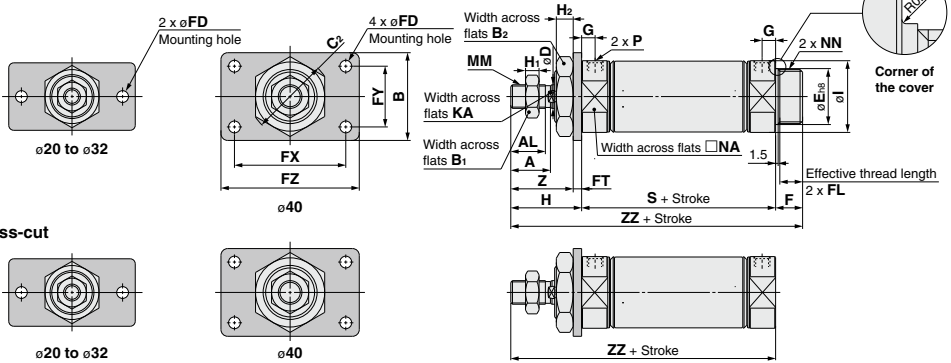

**Boss-cut**

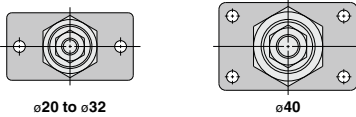

**Rod Flange (F)**

Bore size	A	AL	B	B <sub>1</sub>	B <sub>2</sub>	C <sub>2</sub>	D	E	F	FD	FL	FT	FX	FY	FZ	G	H	H <sub>1</sub>	H <sub>2</sub>
20	14.5	12	34	13	26	30	8	20 <sup>0</sup> <sub>-0.033</sub>	13	7	10.5	4	60	—	75	6	31	5	8
25	17.5	15	40	17	32	37	10	26 <sup>0</sup> <sub>-0.033</sub>	13	7	10.5	4	60	—	75	6	34	6	8
32	17.5	15	40	17	32	37	12	26 <sup>0</sup> <sub>-0.033</sub>	13	7	10.5	4	60	—	75	8	34	6	8
40	23.5	20.5	52	22	41	47.3	14	32 <sup>0</sup> <sub>-0.039</sub>	16	7	13.5	5	66	36	82	8	42	8	10

Bore size	I	KA	MM	NA	NN	P	S	Z	ZZ
20	27.9	Width across flats 6 length 3.5	M8 x 1.25	24	M20 x 1.5	M5 x 0.8	55	27	99
25	33.4	Width across flats 8 length 3.5	M10 x 1.25	30	M26 x 1.5	M5 x 0.8	56	30	103
32	37.4	Width across flats 10 length 3.5	M10 x 1.25	34.5	M26 x 1.5	Rc1/8	62	30	109
40	46.4	Width across flats 12 length 3.5	M14 x 1.5	42.5	M32 x 2	Rc1/8	67	37	125

Bore size	ZZ
20	86
25	90
32	96
40	109

\* Use a thin wrench when tightening the piston rod.

\* Refer to the dimensions of the basic type for the female rod end type and the long male rod end type.

**Head Flange (G): C□M3G** **Bore size** – **Stroke**

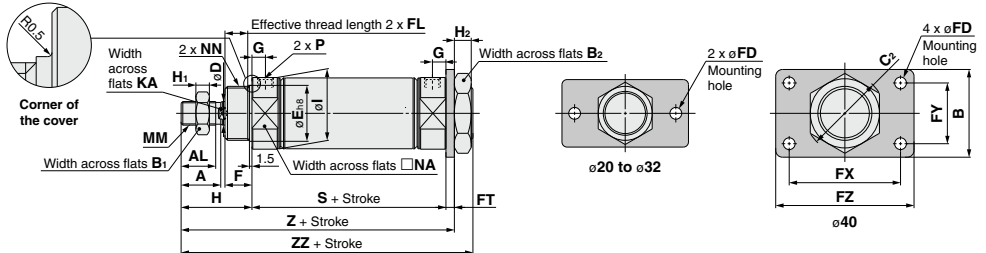

**Head Flange (G)**

Bore size	A	AL	B	B <sub>1</sub>	B <sub>2</sub>	C <sub>2</sub>	D	E	F	FD	FL	FT	FX	FY	FZ	G	H	H <sub>1</sub>	H <sub>2</sub>
20	14.5	12	34	13	26	30	8	20 <sup>0</sup> <sub>-0.033</sub>	13	7	10.5	4	60	—	75	6	31	5	8
25	17.5	15	40	17	32	37	10	26 <sup>0</sup> <sub>-0.033</sub>	13	7	10.5	4	60	—	75	6	34	6	8
32	17.5	15	40	17	32	37	12	26 <sup>0</sup> <sub>-0.033</sub>	13	7	10.5	4	60	—	75	8	34	6	8
40	23.5	20.5	52	22	41	47.3	14	32 <sup>0</sup> <sub>-0.039</sub>	16	7	13.5	5	66	36	82	8	42	8	10

Bore size	I	KA	MM	NA	NN	P	S	Z	ZZ
20	27.9	Width across flats 6 length 3.5	M8 x 1.25	24	M20 x 1.5	M5 x 0.8	55	90	99
25	33.4	Width across flats 8 length 3.5	M10 x 1.25	30	M26 x 1.5	M5 x 0.8	56	94	103
32	37.4	Width across flats 10 length 3.5	M10 x 1.25	34.5	M26 x 1.5	Rc1/8	62	100	109
40	46.4	Width across flats 12 length 3.5	M14 x 1.5	42.5	M32 x 2	Rc1/8	67	114	125

\* Use a thin wrench when tightening the piston rod.

\* Refer to the dimensions of the basic type for the female rod end type and the long male rod end type.

## Dimensions

### Single Clevis (C): C□M3C Bore size – Stroke

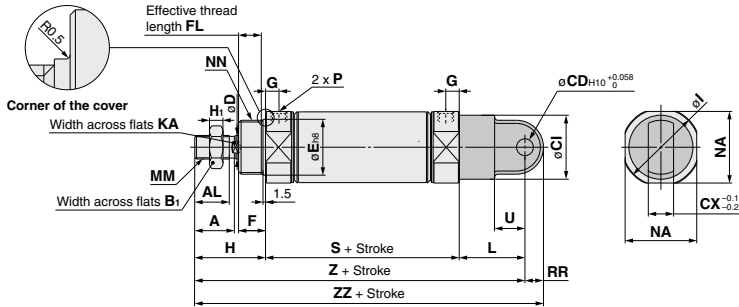

### Single Clevis (C)

Bore size	A	AL	B <sub>1</sub>	CD	CI	CX	D	E	F	FL	G	H	H <sub>1</sub>	I	KA	L
20	14.5	12	13	9	24	10	8	20 <sup>0</sup> <sub>-0.033</sub>	13	10.5	6	31	5	27.9	Width across flats 6 length 3.5	30
25	17.5	15	17	9	30	10	10	26 <sup>0</sup> <sub>-0.033</sub>	13	10.5	6	34	6	33.4	Width across flats 8 length 3.5	30
32	17.5	15	17	9	30	10	12	26 <sup>0</sup> <sub>-0.033</sub>	13	10.5	8	34	6	37.4	Width across flats 10 length 3.5	30
40	23.5	20.5	22	10	38	15	14	32 <sup>0</sup> <sub>-0.039</sub>	16	13.5	8	42	8	46.4	Width across flats 12 length 3.5	39

Bore size	MM	NA	NN	P	RR	S	U	Z	ZZ
20	M8 x 1.25	24	M20 x 1.5	M5 x 0.8	9	55	14	116	125
25	M10 x 1.25	30	M26 x 1.5	M5 x 0.8	9	56	14	120	129
32	M10 x 1.25	34.5	M26 x 1.5	Rc1/8	9	62	14	126	135
40	M14 x 1.5	42.5	M32 x 2	Rc1/8	11	67	18	148	159

\* Use a thin wrench when tightening the piston rod.

\* Refer to the dimensions of the basic type for the female rod end type and the long male rod end type.

### Double Clevis (D): C□M3D Bore size – Stroke

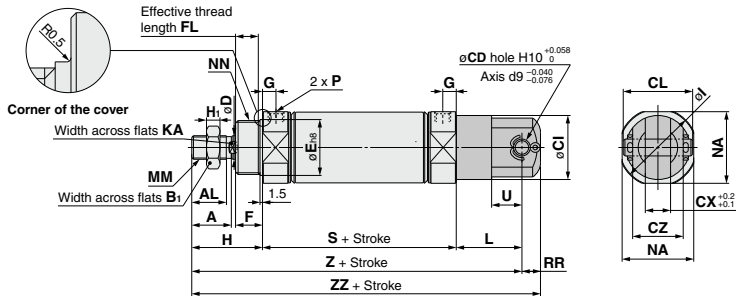

### Double Clevis (D)

Bore size	A	AL	B <sub>1</sub>	CD	CI	CL	CX	CZ	D	E	F	FL	G	H	H <sub>1</sub>	I	KA
20	14.5	12	13	9	24	25	10	19	8	20 <sup>0</sup> <sub>-0.033</sub>	13	10.5	6	31	5	27.9	Width across flats 6 length 3.5
25	17.5	15	17	9	30	25	10	19	10	26 <sup>0</sup> <sub>-0.033</sub>	13	10.5	6	34	6	33.4	Width across flats 8 length 3.5
32	17.5	15	17	9	30	25	10	19	12	26 <sup>0</sup> <sub>-0.033</sub>	13	10.5	8	34	6	37.4	Width across flats 10 length 3.5
40	23.5	20.5	22	10	38	41.2	15	30	14	32 <sup>0</sup> <sub>-0.039</sub>	16	13.5	8	42	8	46.4	Width across flats 12 length 3.5

Bore size	L	MM	NA	NN	P	RR	S	U	Z	ZZ
20	30	M8 x 1.25	24	M20 x 1.5	M5 x 0.8	9	55	14	116	125
25	30	M10 x 1.25	30	M26 x 1.5	M5 x 0.8	9	56	14	120	129
32	30	M10 x 1.25	34.5	M26 x 1.5	Rc1/8	9	62	14	126	135
40	39	M14 x 1.5	42.5	M32 x 2	Rc1/8	11	67	18	148	159

\* A clevis pin and retaining rings (split pins for ø40) are shipped together.

\* Use a thin wrench when tightening the piston rod.

\* Refer to the dimensions of the basic type for the female rod end type and the long male rod end type.

CJ1

CJP

CJ2

JCM

CM2

**CM3**

CG1

CG3

JMB

MB

MB1

CA2

CS1

CS2

D-□

-X□

Technical Data

# CM3 Series

## Dimensions

Rod Trunnion (U): C□M3U **Bore size** – **Stroke**

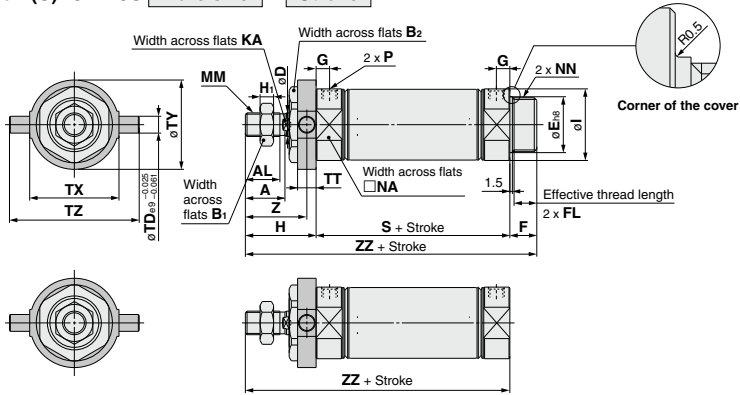

Boss-cut

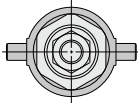

Rod Trunnion (U)

Bore size	A	AL	B <sub>1</sub>	B <sub>2</sub>	D	E	F	FL	G	H	H <sub>1</sub>	I	KA	MM	NA
20	14.5	12	13	26	8	20 <sup>0</sup> <sub>-0.033</sub>	13	10.5	6	31	5	27.9	Width across flats 6 length 3.5	M8 x 1.25	24
25	17.5	15	17	32	10	26 <sup>0</sup> <sub>-0.033</sub>	13	10.5	6	34	6	33.4	Width across flats 8 length 3.5	M10 x 1.25	30
32	17.5	15	17	32	12	26 <sup>0</sup> <sub>-0.033</sub>	13	10.5	8	34	6	37.4	Width across flats 10 length 3.5	M10 x 1.25	34.5
40	23.5	20.5	22	41	14	32 <sup>0</sup> <sub>-0.039</sub>	16	13.5	8	42	8	46.4	Width across flats 12 length 3.5	M14 x 1.5	42.5

Bore size	NN	P	S	TD	TT	TX	TY	TZ	Z	ZZ
20	M20 x 1.5	M5 x 0.8	55	8	10	32	32	52	26	99
25	M26 x 1.5	M5 x 0.8	56	9	10	40	40	60	29	103
32	M26 x 1.5	Rc1/8	62	9	10	40	40	60	29	109
40	M32 x 2	Rc1/8	67	10	11	53	53	77	36.5	125

Boss-cut (mm)	
Bore size	ZZ
20	86
25	90
32	96
40	109

\* Use a thin wrench when tightening the piston rod.

\* Refer to the dimensions of the basic type for the female rod end type and the long male rod end type.

Head Trunnion (T): C□M3T **Bore size** – **Stroke**

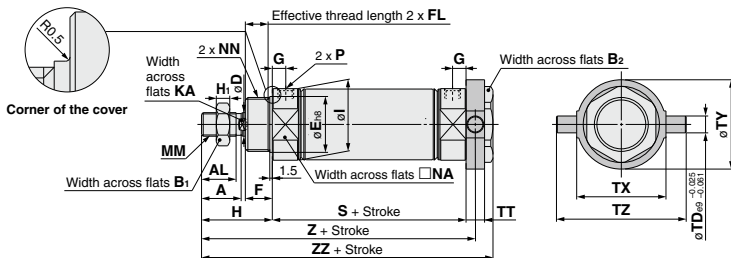

Head Trunnion (T)

Bore size	A	AL	B <sub>1</sub>	B <sub>2</sub>	D	E	F	FL	G	H	H <sub>1</sub>	I	KA	MM	NA
20	14.5	12	13	26	8	20 <sup>0</sup> <sub>-0.033</sub>	13	10.5	6	31	5	27.9	Width across flats 6 length 3.5	M8 x 1.25	24
25	17.5	15	17	32	10	26 <sup>0</sup> <sub>-0.033</sub>	13	10.5	6	34	6	33.4	Width across flats 8 length 3.5	M10 x 1.25	30
32	17.5	15	17	32	12	26 <sup>0</sup> <sub>-0.033</sub>	13	10.5	8	34	6	37.4	Width across flats 10 length 3.5	M10 x 1.25	34.5
40	23.5	20.5	22	41	14	32 <sup>0</sup> <sub>-0.039</sub>	16	13.5	8	42	8	46.4	Width across flats 12 length 3.5	M14 x 1.5	42.5

Bore size	NN	P	S	TD	TT	TX	TY	TZ	Z	ZZ
20	M20 x 1.5	M5 x 0.8	55	8	10	32	32	52	91	101
25	M26 x 1.5	M5 x 0.8	56	9	10	40	40	60	95	105
32	M26 x 1.5	Rc1/8	62	9	10	40	40	60	101	111
40	M32 x 2	Rc1/8	67	10	11	53	53	77	114.5	125

\* Use a thin wrench when tightening the piston rod.

\* Refer to the dimensions of the basic type for the female rod end type and the long male rod end type.



## Dimensions

Integrated Clevis (E): C□M3E Bore size — Stroke

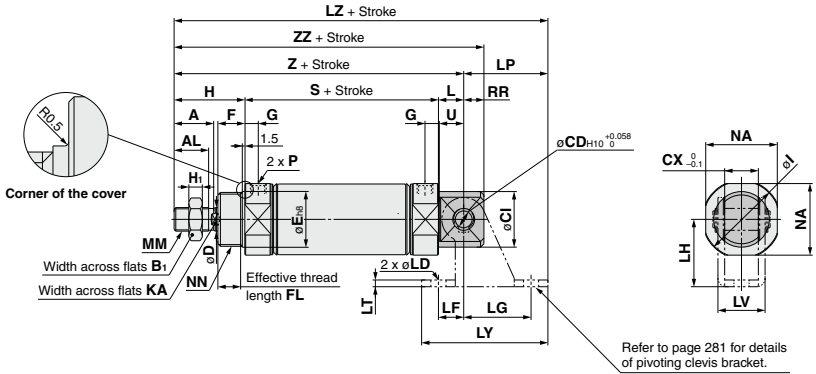

### Integrated Clevis (E)

Bore size	A	AL	B <sub>1</sub>	CD	CI	CX	D	E	F	FL	G	H	H <sub>1</sub>	I	KA	L
20	14.5	12	13	8	20	12	8	20 <sup>0</sup> <sub>-0.033</sub>	13	10.5	6	31	5	27.9	Width across flats 6 length 3.5	12
25	17.5	15	17	8	22	12	10	26 <sup>0</sup> <sub>-0.033</sub>	13	10.5	6	34	6	33.4	Width across flats 8 length 3.5	12
32	17.5	15	17	10	27	20	12	26 <sup>0</sup> <sub>-0.033</sub>	13	10.5	8	34	6	37.4	Width across flats 10 length 3.5	15
40	23.5	20.5	22	10	33	20	14	32 <sup>0</sup> <sub>-0.039</sub>	16	13.5	8	42	8	46.4	Width across flats 12 length 3.5	15

Bore size	MM	NA	NN	P	RR	S	U	Z	ZZ
20	M8 x 1.25	24	M20 x 1.5	M5 x 0.8	9	55	11.5	98	107
25	M10 x 1.25	30	M26 x 1.5	M5 x 0.8	9	56	11.5	102	111
32	M10 x 1.25	34.5	M26 x 1.5	Rc1/8	12	62	14.5	111	123
40	M14 x 1.5	42.5	M32 x 2	Rc1/8	12	67	14.5	124	136

### Pivoting Clevis Bracket

Bore size	LD	LF	LG	LH	LP	LT	LV	LY	LZ
20	6.8	15	30	30	37	3.2	18.4	59	135
25	6.8	15	30	30	37	3.2	18.4	59	139
32	9	15	40	40	50	4	28	75	161
40	9	15	40	40	50	4	28	75	174

\* Use a thin wrench when tightening the piston rod.

\* Refer to the dimensions of the basic type for the female rod end type and the long male rod end type.

- CJ1
- CJP
- CJ2
- JCM
- CM2
- CM3**
- CG1
- CG3
- JMB
- MB
- MB1
- CA2
- CS1
- CS2

D-□  
-X□  
Technical Data

# CM3 Series Dimensions of Accessories 1

## Single Knuckle Joint

(mm)

**I-020B, I-032B** Material: Carbon steel    **I-040B** Material: Free-cutting steel

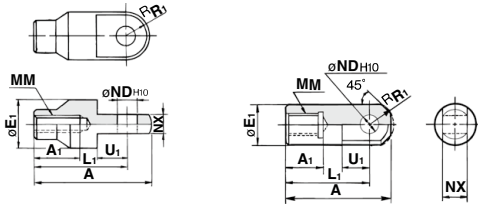

Part no.	Applicable bore size	A	A <sub>1</sub>	E <sub>1</sub>	L <sub>1</sub>	MM	ND <sub>H10</sub>	NX	R <sub>1</sub>	U <sub>1</sub>
<b>I-020B</b>	<b>20</b>	46	16	20	36	M8 x 1.25	9 <sup>+0.058</sup> <sub>0</sub>	9 <sup>-0.1</sup> <sub>-0.2</sub>	10	14
<b>I-032B</b>	<b>25, 32</b>	48	18	20	38	M10 x 1.25	9 <sup>+0.058</sup> <sub>0</sub>	9 <sup>-0.1</sup> <sub>-0.2</sub>	10	14
<b>I-040B</b>	<b>40</b>	69	22	24	55	M14 x 1.5	12 <sup>+0.070</sup> <sub>0</sub>	16 <sup>-0.1</sup> <sub>-0.3</sub>	15.5	20

\* Use a thin wrench when tightening the piston rod.

## Double Knuckle Joint

(mm)

**Y-020B, Y-032B** Material: Carbon steel    **Y-040B** Material: Cast iron

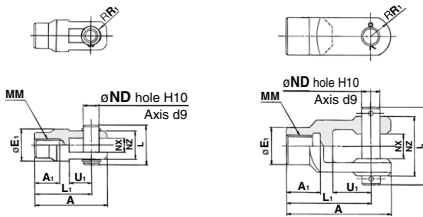

Part no.	Applicable bore size	A	A <sub>1</sub>	E <sub>1</sub>	L	L <sub>1</sub>	MM	ND	NX	NZ	R <sub>1</sub>	U <sub>1</sub>	Included pin part no.	Retaining ring Split pin size
<b>Y-020B</b>	<b>20</b>	46	16	20	25	36	M8 x 1.25	9	9 <sup>+0.2</sup> <sub>-0.1</sub>	18	5	14	CDP-1	Type C9 for axis
<b>Y-032B</b>	<b>25, 32</b>	48	18	20	25	38	M10 x 1.25	9	9 <sup>+0.2</sup> <sub>-0.1</sub>	18	5	14	CDP-1	Type C9 for axis
<b>Y-040B</b>	<b>40</b>	68	22	24	49.7	55	M14 x 1.5	12	16 <sup>+0.3</sup> <sub>-0.1</sub>	38	13	25	CDP-3	Type C9 for axis

\* A knuckle pin and retaining rings (split pins for ø40) are included.

## Double Clevis Pin

(mm)

**Bore size/ø20, ø25, ø32**

**CDP-1** Material: Carbon steel

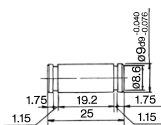

Retaining ring: Type C9 for axis

**Bore size/ø40**

**CDP-2** Material: Carbon steel

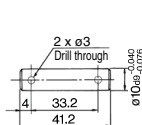

Split pin: ø3 x 18 $\epsilon$

\* Retaining rings (split pins for ø40) are included.

## Double Knuckle Joint Pin

(mm)

**Bore size/ø20, ø25, ø32**

**CDP-1** Material: Carbon steel

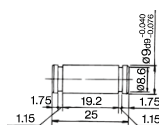

Retaining ring: Type C9 for axis

**Bore size/ø40**

**CDP-3** Material: Carbon steel

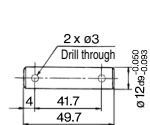

Split pin: ø3 x 18 $\epsilon$

\* Retaining rings (split pins for ø40) are included.

**Rod End Nut** (mm)

Material: Carbon steel

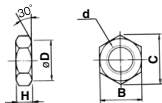

Part no.	Applicable bore size	B	C	D	d	H
NT-02	20	13	15.0	12.5	M8 x 1.25	5
NT-03	25, 32	17	19.6	16.5	M10 x 1.25	6
NT-04	40	22	25.4	21.0	M14 x 1.5	8

**Mounting Nut** (mm)

Material: Carbon steel

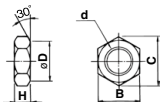

Part no.	Applicable bore size	B	C	D	d	H
SN-020B	20	26	30	25.5	M20 x 1.5	8
SN-032B	25, 32	32	37	31.5	M26 x 1.5	8
SN-040B	40	41	47.3	40.5	M32 x 2.0	10

**Trunnion Nut** (mm)

Material: Carbon steel

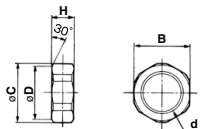

Part no.	Applicable bore size	B	C	D	d	H
TN-020B	20	26	28	25.5	M20 x 1.5	10
TN-032B	25, 32	32	34	31.5	M26 x 1.5	10
TN-040B	40	41	45	40.5	M32 x 2	10

**Pivoting Clevis Bracket (For CM3E)** (mm)

Material: Carbon steel

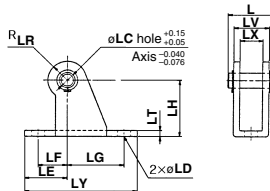

Part no.	Applicable bore size	L	LC	LD	LE	LF	LG	LH	LR
CM-E020B	20, 25	24.5	8	6.8	22	15	30	30	10
CM-E032B	32, 40	34	10	9	25	15	40	40	13

Part no.	Applicable bore size	LT	LX	LY	LV	Included pin part no.
CM-E020B	20, 25	3.2	12	59	18.4	CD-S02
CM-E032B	32, 40	4	20	75	28	CD-S03

Note 1) A pivoting clevis bracket pin and retaining rings are included.  
 Note 2) It cannot be used for the single clevis (CM3C) and double clevis (CM3D) types.

**Pivoting Clevis Bracket Pin (For CM3E)** (mm)

Material: Carbon steel

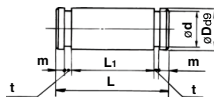

Part no.	Applicable bore size	Dd9	d	L	L1	m	t	Included retaining ring
CD-S02	20, 25	8 <sup>+0.15</sup> <sub>-0.076</sub>	7.6	24.5	19.5	1.6	0.9	Type C8 for axis
CD-S03	32, 40	10 <sup>+0.15</sup> <sub>-0.076</sub>	9.6	34	29	1.35	1.15	Type C10 for axis

Note) Retaining rings are included.

CJ1

CJP

CJ2

JCM

CM2

CM3

CG1

CG3

JMB

MB

MB1

CA2

CS1

CS2

D-□

-X□

Technical Data

# CM3 Series

## Dimensions of Accessories 2

### Dimensions

#### ■ Single Clevis (C)

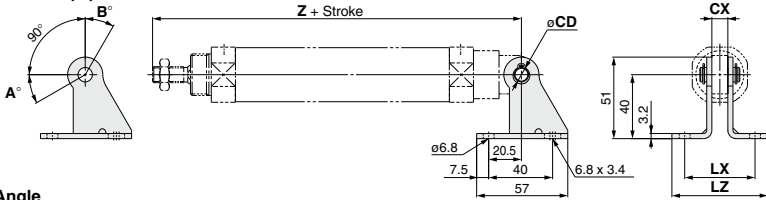

#### Rotating Angle

Bore size (mm)	A°	B°	A° + B° + 90°
20	25	85	200
25, 32	21	81	192
40	26	86	202

Mounting	Part no.	Applicable bore size	CX	Z + Stroke	CD	LX	LZ
CM3C (Single clevis)	CM-B032	20	10	116	9	44	60
		25		120			
		32		126			
	CM-B040	40	15	148	10	49	65

Note 1) A pivoting bracket pin and retaining rings are not included with the pivoting bracket.  
 Note 2) The above dimensions are for the male rod end type.

#### ■ Rod Trunnion (U)

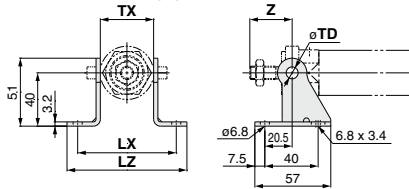

#### ■ Head Trunnion (T)

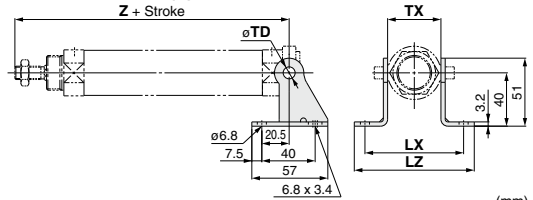

Mounting	Part no.	Applicable bore size	TX	Rod trunnion	Head trunnion	TD	LX	LZ
				Z	Z + Stroke			
CM3U, CM3T (Rod trunnion, Head trunnion)	CM-B020	20	32	26	91	8	66	82
	CM-B032	25	40	29	95	9	74	90
		32			101			
	CM-B040	40	53	36.5	114.5	10	87	103

Note 1) A pivoting bracket pin and retaining rings are not included with the pivoting bracket.  
 Note 2) The above dimensions are for the male rod end type.

#### Pivoting Bracket

■ Pivoting brackets consist of a set of two brackets.

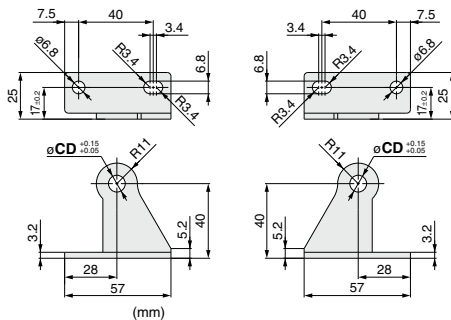

Part no.	CD
CM-B020 (Note 2)	8
CM-B032	9
CM-B040	10

Note 1) A pivoting bracket pin and retaining rings are not included with the pivoting bracket.  
 Note 2) CM-B020 is applicable only for trunnion type.

#### Pivoting Bracket Pin

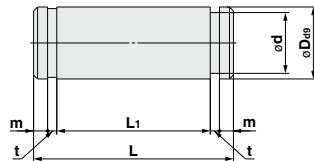

Applicable bore size	Part no.	Dd9	d	L	L1	m	t	Included retaining ring
20, 25, 32	CDP-1	9 <sup>+0.040</sup> / <sub>-0.076</sub>	8.6	25	19.2	1.75	1.15	Type C9 for axis
40	CD-S03	10 <sup>+0.040</sup> / <sub>-0.076</sub>	9.6	34	29	1.35	1.15	Type C10 for axis

Note) Retaining rings are included with the pivoting bracket pin.

# CM3 Series Auto Switch Mounting 1

## Auto Switch Proper Mounting Position (Detection at stroke end) and Its Mounting Height

### Solid state auto switch

- D-M9□
- D-M9□W
- D-M9□A

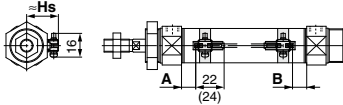

( ): Dimension of the D-M9□A.  
A and B are the dimensions from the end of the head cover/rod cover to the end of the auto switch.

- D-M9□V
- D-M9□WV
- D-M9□AV

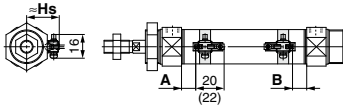

( ): Dimension of the D-M9□AV.  
A and B are the dimensions from the end of the head cover/rod cover to the end of the auto switch.

### D-H7□/H7□W/H7NF/H7BA/H7C

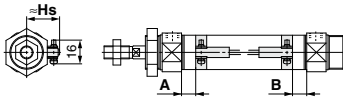

### D-G5NT

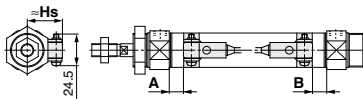

### D-G39A/K39A

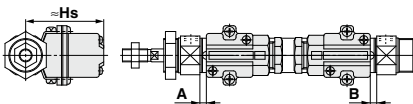

### Reed auto switch

- D-A9□

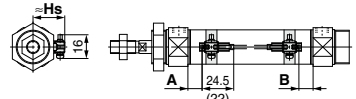

( ): Dimension of the D-A96.  
A and B are the dimensions from the end of the head cover/rod cover to the end of the auto switch.

- D-A9□V

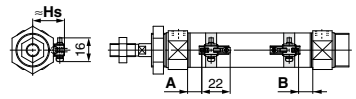

A and B are the dimensions from the end of the head cover/rod cover to the end of the auto switch.

### D-C7/C8/C73C/C80C

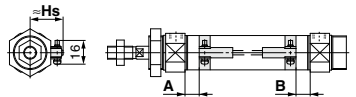

### D-B5/B6/B59W

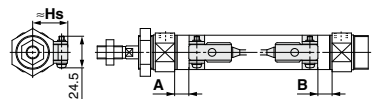

### D-A33A/A34A

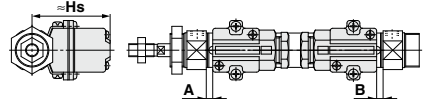

### D-A44A

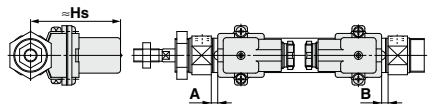

CJ1
CJP
CJ2
JCM
CM2
<b>CM3</b>
CG1
CG3
JMB
MB
MB1
CA2
CS1
CS2

D-□
-X□
Technical Data

# CM3 Series Auto Switch Mounting 2

## Auto Switch Proper Mounting Position (Detection at stroke end) and Its Mounting Height

### Auto Switch Proper Mounting Position

(mm)

Auto switch model	D-M9□(V) D-M9□W(V) D-M9□A(V)		D-A9□(V)		D-B54 D-B64		D-C73C D-C80C		D-B59W		D-A3□A D-A44A D-G39A (Note 2) D-K39A (Note 2)		D-H7C D-H7BA D-H7NF		D-G5NT	
	A	B	A	B	A	B	A	B	A	B	A	B	A	B	A	B
<b>20</b>	10	9	6	5	0.5	0	6.5	5.5	3.5	2.5	0	0	5.5	4.5	2	1
<b>25</b>	10	10	6	6	0.5	0.5	6.5	6.5	3.5	3.5	0	0	5.5	5.5	2	2
<b>32</b>	10	10	6	6	0.5	0.5	6.5	6.5	3.5	3.5	0	0	5.5	5.5	2	2
<b>40</b>	12	12	8	8	2.5	2.5	8.5	8.5	5.5	5.5	2	2	7.5	7.5	4	4

Note 1) Adjust the auto switch after confirming the operating condition in the actual setting.

Note 2) The D-G39A/K39A cannot be mounted on the bore size ø20.

Note 3) For the combination of the following auto switches, bore sizes and mounting positions, the auto switch cannot be mounted to the port side.

- D-G5□ type: On the head side and the rod side of the bore size ø32
- D-B5□/B64 types (except B59W) ... On the head side of the bore size ø20, ø32, On the rod side of the bore size ø32

### Auto Switch Mounting Height

(mm)

Auto switch model	D-M9□V D-M9□WV D-M9□AV D-A9□V		D-M9□ D-M9□W D-M9□A D-A9□ D-H7□ D-H7□W D-H7NF D-H7BA D-C7/C8		D-G5NT D-H7C D-B5□ D-B64 D-B59W		D-C73C D-C80C		D-G39A D-K39A D-A3□A		D-A44A	
	Hs	Hs	Hs	Hs	Hs	Hs	Hs	Hs	Hs	Hs	Hs	
<b>20</b>	23.5	22.5	25.5	25	60	69.5						
<b>25</b>	26	25	28	27.5	62.5	72						
<b>32</b>	29.5	28.5	31.5	31	66	75.5						
<b>40</b>	33.5	32.5	35.5	35	70	79.5						

## Minimum Stroke for Auto Switch Mounting

Auto switch model	n: Number of auto switches (mm)					
	With 1 pc.	With 2 pcs.			With n pcs.	
		Different surfaces	Same surface	Different surfaces	Same surface	
D-M9□	5	20	55	$20 + 35 \frac{(n-2)}{2}$ (n = 2, 4, 6...)	$55 + 35 (n-2)$ (n = 2, 3, 4, 5...)	
D-M9□W	10	20	55	$20 + 35 \frac{(n-2)}{2}$ (n = 2, 4, 6...)	$55 + 35 (n-2)$ (n = 2, 3, 4, 5...)	
D-M9□A	10	25	60	$25 + 35 \frac{(n-2)}{2}$ (n = 2, 4, 6...)	$60 + 35 (n-2)$ (n = 2, 3, 4, 5...)	
D-A9□	5	15	50	$15 + 35 \frac{(n-2)}{2}$ (n = 2, 4, 6...)	$50 + 35 (n-2)$ (n = 2, 3, 4, 5...)	
D-M9□V	5	20	35	$20 + 35 \frac{(n-2)}{2}$ (n = 2, 4, 6...)	$35 + 35 (n-2)$ (n = 2, 3, 4, 5...)	
D-A9□V	5	15	25	$15 + 35 \frac{(n-2)}{2}$ (n = 2, 4, 6...)	$25 + 35 (n-2)$ (n = 2, 3, 4, 5...)	
D-M9□WV D-M9□AV	10	20	35	$20 + 35 \frac{(n-2)}{2}$ (n = 2, 4, 6...)	$35 + 35 (n-2)$ (n = 2, 3, 4, 5...)	
D-C7□ D-C80	5	20	60	$20 + 45 \frac{(n-2)}{2}$ (n = 2, 4, 6...)	$60 + 45 (n-2)$ (n = 2, 3, 4, 5...)	
D-H7□ D-H7□W D-H7BA D-H7NF	10	25	70	$25 + 45 \frac{(n-2)}{2}$ (n = 2, 4, 6...)	$70 + 45 (n-2)$ (n = 2, 3, 4, 5...)	
D-C73C D-C80C D-H7C	15	30	80	$30 + 50 \frac{(n-2)}{2}$ (n = 2, 4, 6...)	$80 + 50 (n-2)$ (n = 2, 3, 4, 5...)	
D-B5□ D-B64 D-G5□ D-K59□	10	25	70	$25 + 50 \frac{(n-2)}{2}$ (n = 2, 4, 6...)	$70 + 50 (n-2)$ (n = 2, 3, 4, 5...)	
D-B59W	15	30	75	$30 + 50 \frac{(n-2)}{2}$ (n = 2, 4, 6...)	$75 + 50 (n-2)$ (n = 2, 3, 4, 5...)	
D-A3□A D-G39A D-K39A D-A44A	20	35	110	$35 + 30 \frac{(n-2)}{2}$ (n = 2, 4, 6...)	$110 + 100 (n-2)$ (n = 2, 3, 4, 5...)	

Note 1) Auto switch mounting

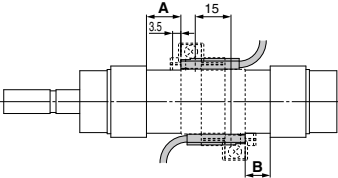
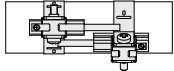
Auto switch model	With 2 auto switches	
	Different surfaces	Same surface
		
	<p>Correct auto switch mounting position is 3.5 mm from the back face of the switch holder.</p>	<p>The auto switch is mounted by slightly displacing it in a direction (cylinder tube circumferential exterior) so that the auto switch and lead wire do not interfere with each other.</p>
D-M9□ D-M9□W	Less than 20 stroke <small>Note 2)</small>	Less than 55 stroke <small>Note 2)</small>
D-M9□A	Less than 25 stroke <small>Note 2)</small>	Less than 60 stroke <small>Note 2)</small>
D-A9□	—	Less than 50 stroke <small>Note 2)</small>

Note 2) Minimum stroke for auto switch mounting in types other than those mentioned in Note 1

**CJ1**

**CJP**

**CJ2**

**JCM**

**CM2**

**CM3**

**CG1**

**CG3**

**JMB**

**MB**

**MB1**

**CA2**

**CS1**

**CS2**

**D-□**

**-X□**

Technical Data

# CM3 Series Auto Switch Mounting 3

## Operating Range

Auto switch model	Bore size (mm)			
	20	25	32	40
D-M9□(V) D-M9□W(V) D-M9□A(V)	3	3	4	3.5
D-A9□	6	6	6	6
D-C7□/C80 D-C73C/C80C	7	8	8	8
D-B5□/B64 D-A3□A/A44A	8	8	9	9
D-B59W	12	12	13	13
D-H7□/H7□W/H7BA D-G5NT/H7NF	4	4	4.5	5
D-H7C	7	8.5	9	10
D-G39A/K39A	8	9	9	9

\* Values which include hysteresis are for guideline purposes only, they are not a guarantee (assuming approximately ±30% dispersion) and may change substantially depending on the ambient environment.

## Auto Switch Mounting Brackets/Part No.

Auto switch model	Bore size (mm)			
	20	25	32	40
D-M9□(V) D-M9□W(V) D-A9□(V)	Note 1 BM5-020	Note 1 BM5-025	Note 1 BM5-032	Note 1 BM5-040
D-M9□A(V)	Note 2 BM5-020S	Note 2 BM5-025S	Note 2 BM5-032S	Note 2 BM5-040S
D-C7□/C80 D-C73C/C80C D-H7□ D-H7□W D-H7NF	BM2-020A	BM2-025A	BM2-032A	BM2-040A
D-H7BA	BM2-020AS	BM2-025AS	BM2-032AS	BM2-040AS
D-B5□/B64 D-B59W D-G5□/K59 D-G5A/K59W D-G5BA/K59F D-G5NT	BA2-020	BA2-025	BA2-032	BA2-040
D-A3□A/A44A D-G39A/K39A	BM3-020	BM3-025	BM3-032	BM3-040

Note 1) Set part number which includes the auto switch mounting band (BM2-□□□A) and the holder kit (BJ5-1/Switch bracket: Transparent).

Since the switch bracket (made from nylon) are affected in an environment where alcohol, chloroform, methylamines, hydrochloric acid or sulfuric acid is splashed over, so it cannot be used. Please consult SMC regarding other chemicals.

Note 2) Set part number which includes the auto switch mounting band (BM2-□□□AS/Stainless steel screw) and the holder kit (BJ4-1/Switch bracket: White).

Note 3) For the D-M9□A (V) type auto switch, do not install the switch bracket on the indicator light.

### [Stainless Steel Mounting Screw]

The following stainless steel mounting screw is available. Use it in accordance with the operating environment. (Since switch mounting bracket is not included, order it separately.)

BBA4: For D-C7/C8/H7 types

Note 4) Refer to page 1682 for details of BBA4 screws.

The above stainless steel screws are used when a cylinder is shipped with the D-H7BAL auto switches. When only an auto switch is shipped independently, the BBA4 screw is attached.

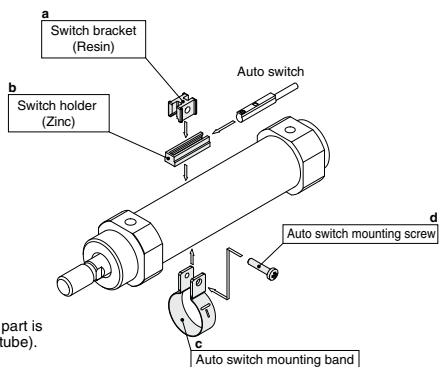

- BJ□-1 is a set of "a" and "b".
- BM2-□□□A(S) is a set of "c" and "d".  
Band (c) is mounted so that the projected part is on the internal side (contact side with the tube).  
BJ4-1 (Switch bracket: White)  
BJ5-1 (Switch bracket: Transparent)

### Other than the applicable auto switches listed in "How to Order," the following auto switches are mountable.

Refer to pages 1575 to 1701 for detailed specifications.

Type	Model	Electrical entry	Features
Solid state auto switch	D-H7A1, H7A2, H7B	Grommet (In-line)	—
	D-H7NW, H7PW, H7BW		Diagnostic indication(2-color indicator)
	D-H7BA		Water resistant(2-color indicator)
	D-G5NT		With timer
Reed auto switch	D-B53, C73, C76	Grommet (In-line)	—
	D-C80		Without indicator light

\* With pre-wired connector is also available for solid state auto switches. For details, refer to pages 1648 and 1649.

\* Normally closed (NC = b contact) solid state auto switches (D-M9□E(V)) are also available. For details, refer to page 1592-1.