

# Air Cylinder: Air-hydro Type Double Acting, Double Rod

## CA2W□H Series

ø40, ø50, ø63, ø80, ø100

### How to Order

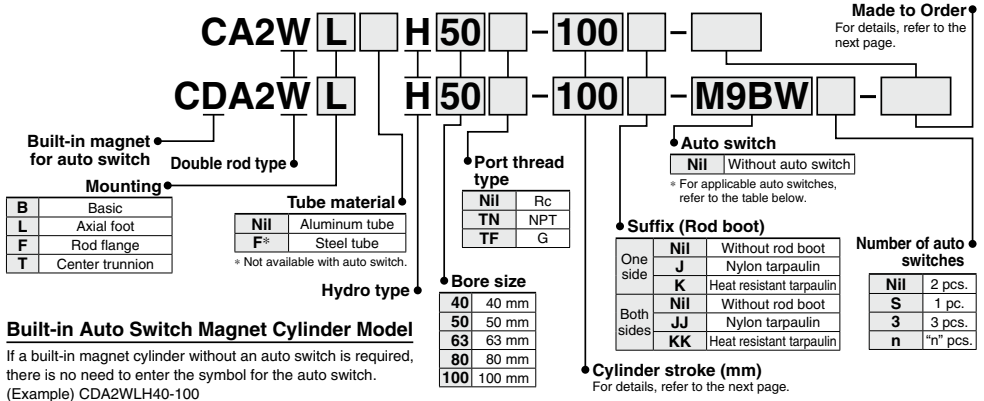

### Applicable Auto Switches/Refer to pages 1271 to 1365 for further information on auto switches.

Type	Special function	Electrical entry	Indicator/light	Wiring (Output)	Load voltage		Auto switch model		Lead wire length (m)					Pre-wired connector	Applicable load
					DC	AC	Tie-rod mounting	Band mounting	0.5 (Nil)	1 (M)	3 (L)	5 (Z)			
Solid state auto switch	—	Grommet	—	3-wire (NPN)	24 V	5 V, 12 V	—	M9N	●	●	●	○	○	IC circuit	—
				3-wire (PNP)				G59	●	●	●	○	○		
				2-wire				M9P	●	●	●	○	○		
				—				G5P	●	●	●	○	○		
				—				M9B	●	●	●	○	○		
				—				K59	●	●	●	○	○		
	Diagnostic indication (2-color indicator)	Terminal conduit	Yes	3-wire (NPN)	12 V	5 V, 12 V	—	G39C	●	●	●	○	○	IC circuit	Relay, PLC
				2-wire				G39	●	●	●	○	○		
				3-wire (NPN)				K39C	●	●	●	○	○		
				3-wire (PNP)				M9NW	●	●	●	○	○		
				2-wire				G59W	●	●	●	○	○		
				—				M9PW	●	●	●	○	○		
Water resistant (2-color indicator)	Grommet	—	2-wire	24 V	12 V	—	M9BW	●	●	●	○	○	—	—	
			3-wire (NPN)				K59W	●	●	●	○	○			
			3-wire (PNP)				M9NA <sup>*1</sup>	—	○	○	○	○			
			2-wire				M9PA <sup>*1</sup>	—	○	○	○	○			
			—				M9BA <sup>*1</sup>	—	○	○	○	○			
			—				G5BA <sup>*1</sup>	—	○	○	○	○			
With diagnostic output (2-color indicator) Magnetic field resistant (2-color indicator)	Grommet	—	4-wire (NPN)	24 V	5 V, 12 V	—	F59F	●	●	●	○	○	IC circuit	—	
			2-wire (Non-polar)				G59F	●	●	●	○	○			
Reed auto switch	—	Grommet	Yes	3-wire (NPN equiv.)	24 V	5 V	—	A96 <sup>*2</sup>	●	●	●	○	○	IC circuit	—
				—				A93 <sup>*2</sup>	●	●	●	○	○		
				—				A90 <sup>*2</sup>	●	●	●	○	○		
				—				A54	●	●	●	○	○		
				—				A64	●	●	●	○	○		
				—				A33C	●	●	●	○	○		
				—				A34C	●	●	●	○	○		
				—				A44C	●	●	●	○	○		
				—				A44	●	●	●	○	○		
				—				A59W	●	●	●	○	○		
Diagnostic indication (2-color indicator)	Terminal conduit	Yes	2-wire	24 V	12 V	—	B54	●	●	●	○	○	IC circuit	Relay, PLC	
							B64	●	●	●	○	○			
							A33C	●	●	●	○	○			
							A34C	●	●	●	○	○			
Diagnostic indication (2-color indicator)	DIN terminal	Yes	2-wire	24 V	100 V, 200 V	—	A44C	●	●	●	○	○	—	Relay, PLC	
							A59W	●	●	●	○	○			

\*1 Water resistant type auto switches can be mounted on the above models, but in such case SMC cannot guarantee water resistance.  
Please contact SMC regarding water resistant types with the above model numbers.

\* Lead wire length symbols: 0.5 m..... Nil (Example) M9NW \* Solid state auto switches marked with "○" are produced upon receipt of order.  
1 m..... M (Example) M9NWM \*\*D-A9□ and D-A9□V types cannot be mounted on ø50. Use D-Z7□ and D-Z80 instead.  
3 m..... L (Example) M9NWL  
5 m..... Z (Example) M9NWX

\* Since there are other applicable auto switches than listed above, refer to page 613 for details.

\* For details about auto switches with pre-wired connector, refer to pages 1340 and 1341.

\* The D-A9□/M9□□/P3DW□ auto switches are shipped together, (but not assembled). (However, auto switch mounting brackets are assembled for the D-A9□/M9□□ before shipment.)

# Air Cylinder: Air-hydro Type Double Acting, Double Rod **CA2W□H Series**

## Specifications

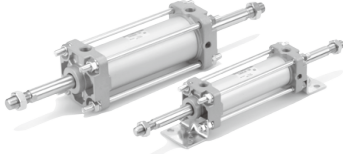

Bore size (mm)	40	50	63	80	100
Type	Air-hydro				
Fluid	Turbine oil				
Action	Double acting				
Proof pressure	1.5 MPa				
Maximum operating pressure	1.0 MPa				
Minimum operating pressure	0.16 MPa				
Piston speed	0.5 to 300 mm/s				
Ambient and fluid temperature	5 to 60°C				
Cushion	None				
Stroke length tolerance	Up to 250 st: <sup>+1.0</sup> <sub>0</sub> , 251 to 750 st: <sup>+1.4</sup> <sub>0</sub>				
Mounting	Basic, Axial foot, Rod flange, Center trunnion				

## Standard Strokes

Bore size	Standard stroke					Stroke range (mm) Note 3)
	40	50	63	80	100	
40	25, 50, 75, 100, 125, 150, 175, 200, 250, 300, 350, 400, 450, 500					1 to 1800
50, 63	25, 50, 75, 100, 125, 150, 175, 200, 250, 300, 350, 400, 450, 500, 600					
80, 100	25, 50, 75, 100, 125, 150, 175, 200, 250, 300, 350, 400, 450, 500, 600, 700					

Note 1) Aside from the standard strokes, intermediate strokes (within stroke range) are also available in 1 mm increments and are produced upon receipt of order.  
Note 2) Applicable strokes should be confirmed according to the usage. For details, refer to "Air Cylinders Model Selection" on front matter pages. In addition, the products that exceed the standard stroke might not be able to fulfill the specifications due to the deflection etc.

Note 3) The stroke range for the type with a rod boot is shown in the table below. Strokes exceeding those in the table below are only available as a special order.

Bore size	Stroke range
40 to 100	20 to 1400 mm

### Symbol

Without cushion

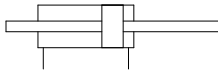

**Made to Order**  
Click here for details

Symbol	Specifications
-XC6	Made of stainless steel
-XC7	Tie-rod, cushion valve, tie-rod nut, etc. made of stainless steel
-XC14	Change of trunnion bracket mounting position
-XC15	Change of tie-rod length
-XC28	Compact flange made of SS400
-XC65	Made of stainless steel (Combination of XC7 and XC68)

Note) Since a heavy duty scraper (-XC4) is installed as standard, there is no need to specify it.

Refer to pages 607 to 613 for cylinders with auto switches.

- Auto switch proper mounting position (detection at stroke end) and its mounting height
- Operating range
- Minimum stroke for auto switch mounting
- Auto switch mounting brackets/Part no.

## Rod Boot Material

Symbol	Rod boot material	Max. ambient temperature
J	Nylon tarpaulin	70°C
K	Heat resistant tarpaulin	110°C*

\* Maximum ambient temperature for the rod boot itself.

\* The rod boot replacement part numbers are listed in the "Maintenance Parts List." [Click here](#) for further details.

## Minimum Stroke for Auto Switch Mounting

### ⚠ Caution

1. The minimum stroke for mounting varies with the auto switch type and cylinder mounting type. In particular, the center trunnion type needs careful attention. (For details, refer to pages 611 and 612.)

## Accessories

Standard	Mounting				
	Rod end nut	Basic	Foot	Flange	Center trunnion
Option	Single knuckle joint	●	●	●	●
	Double knuckle joint (with pin)	●	●	●	●
	With rod boot	●	●	●	●

\* Refer to page 575 for part numbers and dimensions.

## Weights/Aluminum Tube (Steel Tube)

Bore size (mm)		40	50	63	80	100
		(1.08)	(1.64)	(2.30)	(4.09)	(5.78)
Basic weight	Basic	1.03	1.59	2.26	3.94	5.57
	Axial foot	1.22	1.81	2.59	4.61	6.65
	Flange	1.40	2.05	3.05	5.39	7.49
	Trunnion	1.39	2.07	3.06	5.49	7.85
		(1.49)	(2.18)	(3.25)	(5.78)	(8.24)
Additional weight per 50 mm of stroke	All mounting brackets (Except steel tube trunnion)	0.30	0.40	0.50	0.71	0.92
	Steel tube trunnion	(0.44)	(0.58)	(0.77)	(1.06)	(1.35)
	Accessories	Single knuckle	0.23	0.26	0.26	0.60
	Double knuckle (with pin)	0.37	0.43	0.43	0.87	1.27

Calculation: (Example) **CA2WLH40-100** (Axial foot, ø40, 100 stroke) \* Values inside the parentheses are those for the steel tube type.

- Basic weight ..... 1.22 (Axial foot, ø40)
- Additional weight..... 0.30/50 stroke
- Cylinder stroke ..... 100 stroke

1.22 + 0.30 x 100/50 = **1.82 kg**

## Mounting Bracket Part No.

Bore size (mm)	40	50	63	80	100
Axial foot*	CA2-L04	CA2-L05	CA2-L06	CA2-L08	CA2-L10
Flange	CA2-F04	CA2-F05	CA2-F06	CA2-F08	CA2-F10

\* When axial foot brackets are used, order two pieces per cylinder.

# CA2W□H Series

## Construction

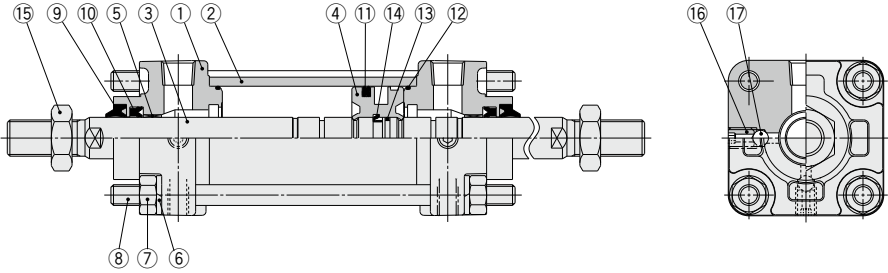

### Component Parts

No.	Description	Material	Note
1	Rod cover	Aluminum alloy	Metallic painted
2	Cylinder tube	Aluminum alloy	Hard anodized
3	Piston rod	Carbon steel	Hard chrome plating
4	Piston	Aluminum alloy	Chromated
5	Bushing	Bearing alloy	
6	Spring washer	Rolled steel	Chromated
7	Tie-rod nut	Rolled steel	Nickel plating
8	Tie-rod	Carbon steel	Zinc chromated
9	Scraper	NBR	
10	Rod seal	NBR	
11	Piston seal	NBR	
12	Cylinder tube gasket	NBR	
13	Piston gasket	NBR	
14	Piston holder	Urethane	
15	Rod end nut	Rolled steel	Nickel plating
16	Air release valve	Chromium molybdenum steel	Black zinc chromated
17	Check ball	Bearing steel	

### Replacement Parts: Seal Kit

Bore size (mm)	Kit no.	Contents
	Air-hydro type	
40	CA2WH40A-PS	Set of the nos. ⑩, ⑪, ⑫.
50	CA2WH50A-PS	
63	CA2WH63A-PS	
80	CA2WH80A-PS	
100	CA2WH100A-PS	

\* Do not disassemble the trunnion type. Refer to page 615.

\* Seal kit includes ⑩, ⑪ and ⑫. Order the seal kit based on each bore size.

\* Seal kit includes a grease pack (ø40, ø50: 10 g, ø63 or more: 20 g).

Order with the following part number when only the grease pack is needed.

**Grease pack part number: GR-S-010 (10 g), GR-S-020 (20 g)**

# Air Cylinder: Air-hydro Type Double Acting, Double Rod **CA2W□H Series**

## Basic: C□A2WBH

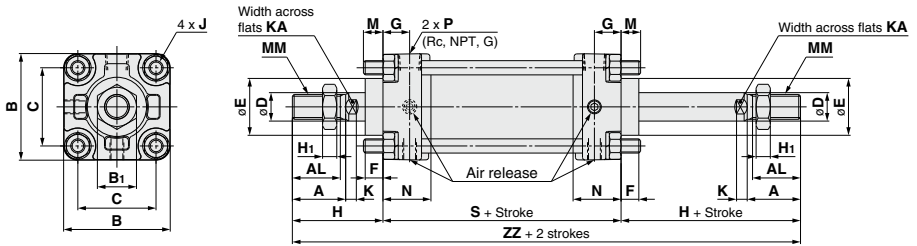

### With rod boot (One side)

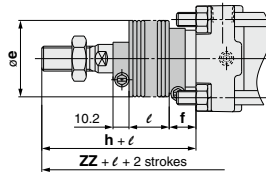

### With rod boot (Both sides)

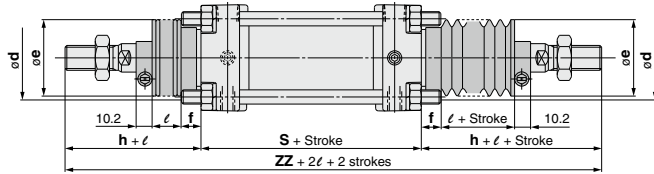

																(mm)	
Bore size (mm)	A	AL	B	B <sub>1</sub>	C	D	E	F	G	H <sub>1</sub>	J	K	KA	M	MM	N	
40	30	27	60	22	44	16	32	10	15	8	M8 x 1.25	6	14	11	M14 x 1.5	27	
50	35	32	70	27	52	20	40	10	17	11	M8 x 1.25	7	18	11	M18 x 1.5	30	
63	35	32	85	27	64	20	40	10	17	11	M10 x 1.25	7	18	14	M18 x 1.5	31	
80	40	37	102	32	78	25	52	14	21	13	M12 x 1.75	11	22	17	M22 x 1.5	37	
100	40	37	116	41	92	30	52	14	21	16	M12 x 1.75	11	26	17	M26 x 1.5	40	

Bore size (mm)	P	S	Without rod boot		With rod boot (One side)						Both sides	
			H	ZZ	d	e	f	h	l	ZZ	ZZ	
40	1/4	84	51	186	56	43	11.2	59	1/4 stroke	194	202	
50	3/8	90	58	206	64	52	11.2	66	1/4 stroke	214	222	
63	3/8	98	58	214	64	52	11.2	66	1/4 stroke	222	230	
80	1/2	116	71	258	76	65	12.5	80	1/4 stroke	267	276	
100	1/2	126	72	270	76	65	14.0	81	1/4 stroke	279	288	

The dimensions for each mounting type are the same as the standard double acting double rod model. Refer to pages 580 to 583. For details about accessories (options), refer to page 575.

# CA2 Series Auto Switch Mounting

## Auto Switch Proper Mounting Position (Detection at stroke end) and Its Mounting Height

### <Band mounting>

D-B5□/B64/B59W

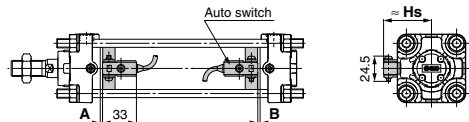

D-A3□  
D-G39/K39

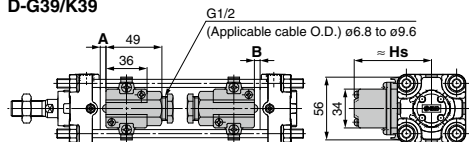

D-G5□/K59      D-G5BA  
D-G5□W/K59W    D-G59F/G5NT

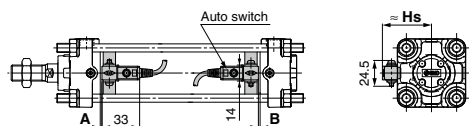

D-A44

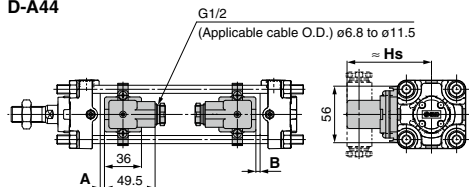

### <Tie-rod mounting>

D-M9□/M9□V      D-Y59□/Y69□/Y7P/Y7PV  
D-M9□W/M9□WV    D-Y7□W/Y7□WV  
D-M9□A/M9□AV    D-Y7BA  
D-A9□/A9□V      D-Z7□/Z80

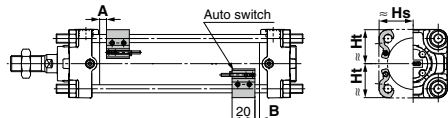

D-A5□/A6□  
D-A59W

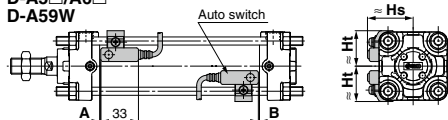

D-G39C/K39C  
D-A3□C

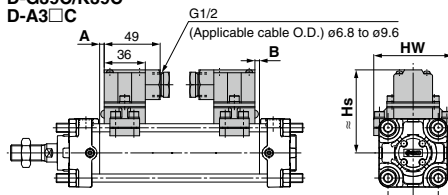

D-F5□/J59      D-F5□W/J59W  
D-F5NT      D-F5BA/F59F

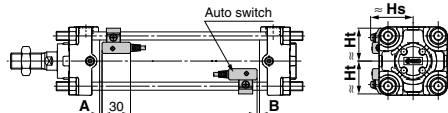

D-A44C

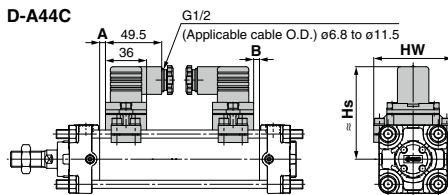

D-P3DWA

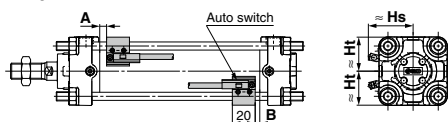

D-P4DW

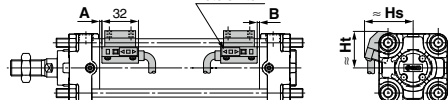

## Auto Switch Proper Mounting Position (Detection at stroke end) and Its Mounting Height

### Auto Switch Proper Mounting Position (Standard type)

(mm)

Auto switch model	D-M9□ D-M9□V D-M9□W D-M9□A D-M9□AV		D-A9□ D-A9□V		D-Y59□ D-Y69□ D-Y7P D-Y7PV D-Y7□W D-Y7□WV D-Y7BA D-Z7□ D-Z80 D-B59W		D-P3DWA		D-P4DW		D-F5□ D-J59 D-F59F D-F5□W D-J59W D-F5BA		D-F5NT		D-A59W		D-G39 D-G39C D-K39 D-K39C D-A5□ D-A6□ D-A3□ D-A3□C D-A44 D-A44C		D-G5□ D-K59 D-G5NT D-G5□W D-K59W D-G5BA D-G59F		D-B5□ D-B64		
	A	B	A	B	A	B	A	B	A	B	A	B	A	B	A	B	A	B	A	B	A	B	A
<b>40</b>	9	9	5	5	2.5	2.5	4.5	4.5	2	2	5.5	5.5	10.5	10.5	3	3	0	0	1	1	0	0	
<b>50</b>	9.5	8.5	5.5	4.5	3	2	5	4	2.5	1.5	6	5	11	10	3.5	2.5	0	0	1.5	0.5	0	0	
<b>63</b>	12.5	11.5	8.5	7.5	6	5	8	7	5.5	4.5	9	8	14	13	6.5	5.5	2.5	1.5	4.5	3.5	3	2	
<b>80</b>	16.5	13.5	12.5	9.5	10	7	12	9	9.5	6.5	13	10	18	15	10.5	7.5	6.5	3.5	8.5	5.5	7	4	
<b>100</b>	18	16	14	12	11.5	9.5	13.5	11.5	11	9	14.5	12.5	19.5	17.5	12	10	8	6	10	8	8.5	6.5	

Note) Adjust the auto switch after confirming the operating conditions in the actual setting.

### Auto Switch Proper Mounting Height (Standard type)

(mm)

Auto switch model	D-M9□ D-M9□W D-M9□A D-A9□		D-M9□V D-M9□WV D-M9□AV		D-A9□V		D-Y59□ D-Y7P D-Y7BA D-Y7□W D-Z7□ D-Z80		D-Y69□ D-Y7PV D-Y7□WV		D-P3DWA		D-P4DW		D-G5□ D-K59 D-G5NT D-G5□W D-K59W D-G5BA D-G59F D-B5□ D-B64 D-B59W		D-G39 D-K39 D-A3□		D-A44		D-F5□ D-J59 D-F5□W D-J59W D-F5BA D-F59F D-F5NT		D-A5□ D-A6□ D-A59W		D-G39C D-K39C D-A3□C		D-A44C		
	Hs	Ht	Hs	Ht	Hs	Ht	Hs	Ht	Hs	Ht	Hs	Ht	Hs	Ht	Hs	Ht	Hs	Ht	Hs	Ht	Hs	Ht	Hs	Ht	Hs	Ht	Hs	Ht	Hs
<b>40</b>	30	30	34	30	31	30	30	30	30	30	37.5	35	42.5	33	37	71.5	81.5	38	31.5	38.5	31.5	73	69	81	69				
<b>50</b>	34	34	38	34	35	34	34	34	34	41.5	39	46.5	37.5	42	76.5	86.5	42	35.5	42	35.5	78.5	77	86.5	77					
<b>63</b>	41	41	44	41	41.5	41	41	41	41	50	41	52	43	49	83.5	93.5	47	43	46.5	43	85.5	91	93.5	91					
<b>80</b>	49.5	49	52.5	49	50	49	49.5	49	49.5	49	58	49	58.5	51.5	57.5	92	102	53.5	51	53.5	51	94	107	102	107				
<b>100</b>	56.5	56	61	56	58.5	56	56.5	55.5	57.5	55.5	66	56	66	58.5	68	102.5	112.5	61	57.5	61.5	57.5	104	121	112	121				

**Auto Switch Proper Mounting Position (Detection at stroke end) and Its Mounting Height**

**Auto Switch Proper Mounting Position (Non-rotating rod type, With end lock)**

(mm)

Auto switch model	D-M9□ D-M9□V D-M9□W D-M9□A D-M9□AV		D-A9□ D-A9□V		D-Y59□ D-Y69□ D-Y7P D-Y7PV D-Y7□W D-Y7□WV D-Y7BA D-B59W D-Z7□ D-Z80		D-P3DWA		D-P4DW		D-G39 D-G39C D-K39 D-K39C D-A5□ D-A6□ D-A3□ D-A3□C D-A44 D-A44C		D-G5□ D-K59 D-G5NT D-G5□W D-K59W D-G5BA D-G59F		D-B5□ D-B64		D-F5□ D-J59 D-F59F D-F5□W D-J59W D-F5BA		D-F5NT		D-A59W	
	A	B	A	B	A	B	A	B	A	B	A	B	A	B	A	B	A	B	A	B	A	B
<b>40</b>	10	8	6	4	4	1	5.5	3.5	3.5	0.5	0.5	0	2.5	0	1	0	7	4	12	9	4.5	1.5
<b>50</b>	10	8	6	4	3.5	1.5	5.3	3.5	3	1	0	0	2	0	0.5	0	6.5	4.5	11.5	9.5	4	2
<b>63</b>	12.5	11.5	8.5	7.5	6	5	8	7	5.5	4.5	2.5	1.5	4.5	3.5	3	2	9	8	14	13	6.5	5.5
<b>80</b>	16	14	12	10	9.5	7.5	11.5	9.5	9	7	6	4	8	6	6.5	4.5	12.5	10.5	17.5	15.5	10	8
<b>100</b>	17.5	16.5	13.5	12.5	11	10	13	12	10.5	9.5	7.5	6.5	9.5	8.5	8	7	14	13	19	18	11.5	10.5

Note) Adjust the auto switch after confirming the operating conditions in the actual setting.

**Auto Switch Proper Mounting Height (Non-rotating rod type, With end lock)**

(mm)

Auto switch model	D-M9□ D-M9□V D-M9□W D-M9□A D-A9□		D-M9□V D-M9□W D-M9□AV		D-A9□V		D-Y59□ D-Y7P D-Y7PV D-Y7□W D-Y7BA D-Z7□ D-Z80		D-Y69□ D-Y7PV D-Y7□W		D-P3DWA		D-P4DW		D-G5□ D-K59 D-G5□W D-K59W D-G59F D-G5BA D-G5NT D-B5□ D-B64 D-B59W		D-G39 D-K39 D-A3□		D-A44		D-F5□ D-J59 D-F59W D-F59F D-F5BA D-F5NT		D-A5□ D-A6□		D-G39C D-K39C D-A3□C		D-A44C	
	Hs	Ht	Hs	Ht	Hs	Ht	Hs	Ht	Hs	Ht	Hs	Ht	Hs	Ht	Hs	Ht	Hs	Ht	Hs	Ht	Hs	Ht	Hs	Ht	Hs	Ht	Hs	Ht
<b>40</b>	30	30	34	30	31	30	30	30	30	30	37.5	35	42.5	33	37	71.5	81.5	38	31.5	38.5	31.5	73	69	81	69			
<b>50</b>	34	34	38	34	35	34	34	34	34	34	41.5	39	46.5	37.5	42	76.5	86.5	42	35.5	42	35.5	78.5	77	86.5	77			
<b>63</b>	41	41	44	41	41.5	41	41	41	41	41	50	41	52	43	49	83.5	93	47	43	46.5	43	85.5	91	93.5	91			
<b>80</b>	49.5	49	52.5	49	50	49	49.5	49	49.5	49	58	49	58.5	51.5	57.5	92	102	53.5	51	53.5	51	94	107	102	107			
<b>100</b>	56.5	56	61	56	58.5	56	58.5	55.5	57.5	55.5	66	56	66	58.5	68	102.5	112.5	61	57.5	61.5	57.5	104	121	112	121			

## Auto Switch Proper Mounting Position (Detection at stroke end) and Its Mounting Height

### Auto Switch Proper Mounting Position (Air-hydro type)

(mm)

Auto switch model	D-M9□ D-M9□V D-M9□W D-M9□WV D-M9□A D-M9□AV		D-A9□ D-A9□V		D-Y59□ D-Y69□ D-Y7P D-Y7PV D-Y7□W D-Y7□WV D-Y7BA D-B59W D-Z7□ D-Z80		D-P3DWA		D-P4DW		D-G39 D-G39C D-K39 D-K39C D-A5□ D-A6□ D-A3□ D-A3□C D-A44 D-A44C		D-G5□ D-K59 D-G5NT D-G5□W D-K59W D-G5BA D-G59F		D-B5□ D-B64		D-F5□ D-J59 D-F59F D-F5□W D-J59W D-F5BA		D-F5NT		D-A59W		
	A	B	A	B	A	B	A	B	A	B	A	B	A	B	A	B	A	B	A	B	A	B	A
<b>40</b>	10	8	6	4	4	1	5.5	3.5	3	1	0	0	2	0	0.5	0	6.5	4.5	11.5	9.5	4	2	
<b>50</b>	10	8	—	—	3.5	1.5	5.5	3.5	3	1	0	0	2	0	0.5	0	6.5	4.5	11.5	9.5	4	2	
<b>63</b>	12.5	11.5	—	—	6	5	8	7	5.5	4.5	2.5	1.5	4.5	3.5	3	2	9	8	14	13	6.5	5.5	
<b>80</b>	16	14	12	10	9.5	7.5	11.5	9.5	9	7	6	4	8	6	6.5	4.5	12.5	10.5	17.5	15.5	10	8	
<b>100</b>	17.5	16.5	13.5	12.5	11	10	13	12	10.5	9.5	7.5	6.5	9.5	8.5	8	7	14	13	19	18	11.5	10.5	

\* D-A9□ and D-A9□V types cannot be mounted on ø50.

Note) Adjust the auto switch after confirming the operating conditions in the actual setting.

### Auto Switch Proper Mounting Height (Air-hydro type)

(mm)

Auto switch model	D-M9□ D-M9□V D-M9□A D-A9□		D-M9□V D-M9□W D-M9□AV		D-A9□V		D-Y59□ D-Y7P D-Y7BA D-Y7□W D-Z7□ D-Z80		D-Y69□ D-Y7PV D-Y7□WV		D-P3DWA		D-P4DW		D-G5□ D-K59 D-G5NT D-G5□W D-K59W D-G5BA D-G59F D-B5□ D-B64 D-B59W		D-G39 D-K39 D-A3□		D-A44		D-F5□ D-J59 D-F5□W D-J59W D-F59F D-F5NT		D-A5□ D-A6□ D-A59W		D-G39C D-K39C D-A3□C		D-A44C		
	Hs	Ht	Hs	Ht	Hs	Ht	Hs	Ht	Hs	Ht	Hs	Ht	Hs	Ht	Hs	Ht	Hs	Ht	Hs	Ht	Hs	Ht	Hs	Ht	Hs	Ht	Hs	Ht	Hs
<b>40</b>	30	30	35	30	32	30	30	30	30.5	30	38	36	43	33.5	38	38	72.5	82.5	82.5	38.5	31	40	31	73	69	81	69		
<b>50</b>	34	34	39	34	—	—	34	34	35	34	42	40.5	47	38	43.5	78	88	88	42.5	35	43.5	35	78.5	77	86.5	77			
<b>63</b>	41	41	46	41	43.5	41	41	41	42.5	41	51	41	53	44	51	85.5	95.5	95.5	48	42	49	42	85.5	91	93.5	91			
<b>80</b>	49.5	49	54	49	51.5	49	49.5	48.5	51	48.5	59	49	60	52	59	93.5	103.5	103.5	54	50	55.5	50	94	107	102	107			
<b>100</b>	57	56	62.5	56	59.5	56	58.5	56	59	56	67	56	67	59	69.5	104	114	114	62	57.5	63	57.5	104	121	112	121			

\* D-A9□ and D-A9□V types cannot be mounted on ø50.

## Operating Range

(mm)

Auto switch model	Bore size				
	40	50	63	80	100
D-M9□/M9□V D-M9□W/M9□WV D-M9□A/M9□AV	4.5	5	5.5	5	6
D-A9□/A9□V	7.5 (7)	8.5 (—)	9.5 (9)	9.5 (9)	10.5 (9)
D-Z7□/Z80	8.5	7.5	9.5	9.5	10.5
D-A3□/A44 D-A3□C/A44C	9	10	11	11	11
D-A5□/A6□					
D-B5□/B64					
D-A59W	13	13	14	14	15
D-B59W	14	14	17	16	18

Auto switch model	Bore size				
	40	50	63	80	100
D-Y59□/Y69□ D-Y7P/Y7□V D-Y7□W/Y7□WV D-Y7BA	8	7	5.5	6.5	6.5
D-F5□/J59/F5□W D-J59W/F5BA D-F5NT/F59F	4	4	4.5	4.5	4.5
D-G5□/K59/G5□W D-K59W/G5BA D-G5NT/G59F	5	6	6.5	6.5	7
D-G39/K39 D-G39C/K39C	9	9	10	10	11
D-P3DWA	4.5	4.5	5.5	5.5	5.5
D-P4DW	4	4	4.5	4	4.5

\* Values which include hysteresis are for guideline purposes only, they are not a guarantee (assuming approximately ±30% dispersion) and may change substantially depending on the ambient environment.

Note 1) ( ): For CDA2□H and CDA2W□H Series.

Note 2) D-A9□ and D-A9□V types cannot be mounted on ø50 of the CDA2□H and CDA2W□H series.



**Minimum Stroke for Auto Switch Mounting**

n: Number of auto switches (mm)

Auto switch model	Number of auto switches	Brackets other than center trunnion	Center trunnion				
			ø40	ø50	ø63	ø80	ø100
D-M9□ D-M9□W	2 (Different surfaces and same surface) 1	15	80		85	90	95
	n	$15 + 40 \frac{(n-2)}{2}$ (n = 2, 4, 6, 8... Note 1)	$80 + 40 \frac{(n-4)}{2}$ (n = 4, 8, 12, 16... Note 2)		$85 + 40 \frac{(n-4)}{2}$ (n = 4, 8, 12, 16... Note 2)	$90 + 40 \frac{(n-4)}{2}$ (n = 4, 8, 12, 16... Note 2)	$95 + 40 \frac{(n-4)}{2}$ (n = 4, 8, 12, 16... Note 2)
D-M9□V D-M9□WV	2 (Different surfaces and same surface) 1	10	55		60	65	70
	n	$10 + 30 \frac{(n-2)}{2}$ (n = 2, 4, 6, 8... Note 1)	$55 + 30 \frac{(n-4)}{2}$ (n = 4, 8, 12, 16... Note 2)		$60 + 30 \frac{(n-4)}{2}$ (n = 4, 8, 12, 16... Note 2)	$65 + 30 \frac{(n-4)}{2}$ (n = 4, 8, 12, 16... Note 2)	$70 + 30 \frac{(n-4)}{2}$ (n = 4, 8, 12, 16... Note 2)
D-M9□A	2 (Different surfaces and same surface) 1	15	80		85	95	100
	n	$15 + 40 \frac{(n-2)}{2}$ (n = 2, 4, 6, 8... Note 1)	$80 + 40 \frac{(n-4)}{2}$ (n = 4, 8, 12, 16... Note 2)		$85 + 40 \frac{(n-4)}{2}$ (n = 4, 8, 12, 16... Note 2)	$95 + 40 \frac{(n-4)}{2}$ (n = 4, 8, 12, 16... Note 2)	$100 + 40 \frac{(n-4)}{2}$ (n = 4, 8, 12, 16... Note 2)
D-M9□AV	2 (Different surfaces and same surface) 1	10	60		65	70	75
	n	$10 + 30 \frac{(n-2)}{2}$ (n = 2, 4, 6, 8... Note 1)	$60 + 30 \frac{(n-4)}{2}$ (n = 4, 8, 12, 16... Note 2)		$65 + 30 \frac{(n-4)}{2}$ (n = 4, 8, 12, 16... Note 2)	$70 + 30 \frac{(n-4)}{2}$ (n = 4, 8, 12, 16... Note 2)	$75 + 30 \frac{(n-4)}{2}$ (n = 4, 8, 12, 16... Note 2)
D-A9□	2 (Different surfaces and same surface) 1	15	75		80	85	90
	n	$15 + 40 \frac{(n-2)}{2}$ (n = 2, 4, 6, 8... Note 1)	$75 + 40 \frac{(n-4)}{2}$ (n = 4, 8, 12, 16... Note 2)		$80 + 40 \frac{(n-4)}{2}$ (n = 4, 8, 12, 16... Note 2)	$85 + 40 \frac{(n-4)}{2}$ (n = 4, 8, 12, 16... Note 2)	$90 + 40 \frac{(n-4)}{2}$ (n = 4, 8, 12, 16... Note 2)
D-A9□V	2 (Different surfaces and same surface) 1	10	50		55	60	65
	n	$10 + 30 \frac{(n-2)}{2}$ (n = 2, 4, 6, 8... Note 1)	$50 + 30 \frac{(n-4)}{2}$ (n = 4, 8, 12, 16... Note 2)		$55 + 30 \frac{(n-4)}{2}$ (n = 4, 8, 12, 16... Note 2)	$60 + 30 \frac{(n-4)}{2}$ (n = 4, 8, 12, 16... Note 2)	$65 + 30 \frac{(n-4)}{2}$ (n = 4, 8, 12, 16... Note 2)
D-F5□/J59 D-F5□W/J59W D-F5BA/F59F D-A5□/A6	2 (Different surfaces and same surface) 1	15	90		100	110	120
	n (Same surface)	$15 + 55 \frac{(n-2)}{2}$ (n = 2, 4, 6, 8... Note 1)	$90 + 55 \frac{(n-4)}{2}$ (n = 4, 8, 12, 16... Note 2)		$100 + 55 \frac{(n-4)}{2}$ (n = 4, 8, 12, 16... Note 2)	$110 + 55 \frac{(n-4)}{2}$ (n = 4, 8, 12, 16... Note 2)	$120 + 55 \frac{(n-4)}{2}$ (n = 4, 8, 12, 16... Note 2)
D-F5NT	2 (Different surfaces and same surface) 1	25	110		120	130	140
	n (Same surface)	$25 + 55 \frac{(n-2)}{2}$ (n = 2, 4, 6, 8... Note 1)	$110 + 55 \frac{(n-4)}{2}$ (n = 4, 8, 12, 16... Note 2)		$120 + 55 \frac{(n-4)}{2}$ (n = 4, 8, 12, 16... Note 2)	$130 + 55 \frac{(n-4)}{2}$ (n = 4, 8, 12, 16... Note 2)	$140 + 55 \frac{(n-4)}{2}$ (n = 4, 8, 12, 16... Note 2)
D-A59W	2 (Different surfaces and same surface) 1	20	90		100	110	120
	n (Same surface)	$20 + 55 \frac{(n-2)}{2}$ (n = 2, 4, 6, 8... Note 1)	$90 + 55 \frac{(n-4)}{2}$ (n = 4, 8, 12, 16... Note 2)		$100 + 55 \frac{(n-4)}{2}$ (n = 4, 8, 12, 16... Note 2)	$110 + 55 \frac{(n-4)}{2}$ (n = 4, 8, 12, 16... Note 2)	$120 + 55 \frac{(n-4)}{2}$ (n = 4, 8, 12, 16... Note 2)
	1	15	90		100	110	120
D-G5□/K59 D-G5□W D-K59W D-G5BA D-G59F D-G5NT D-B5□/B64	2 Different surfaces	15	90	100	110		
	Same surface	75					
	n	Different surfaces	$15 + 50 \frac{(n-2)}{2}$ (n = 2, 4, 6, 8... Note 1)	$90 + 50 \frac{(n-4)}{2}$ (n = 4, 8, 12, 16... Note 2)	$100 + 50 \frac{(n-4)}{2}$ (n = 4, 8, 12, 16... Note 2)	$110 + 50 \frac{(n-4)}{2}$ (n = 4, 8, 12, 16... Note 2)	
		Same surface	$75 + 50 (n-2)$ (n = 2, 3, 4...)	$90 + 50 (n-2)$ (n = 2, 4, 6, 8... Note 1)	$100 + 50 (n-2)$ (n = 2, 4, 6, 8... Note 1)	$110 + 50 (n-2)$ (n = 2, 4, 6, 8... Note 1)	
	1	10	90	100	110		
D-B59W	2 Different surfaces	20	90	100	110		
	Same surface	75					
	n	Different surfaces	$20 + 50 \frac{(n-2)}{2}$ (n = 2, 4, 6, 8... Note 1)	$90 + 50 \frac{(n-4)}{2}$ (n = 4, 8, 12, 16... Note 2)	$100 + 50 \frac{(n-4)}{2}$ (n = 4, 8, 12, 16... Note 2)	$110 + 50 \frac{(n-4)}{2}$ (n = 4, 8, 12, 16... Note 2)	
		Same surface	$75 + 50 (n-2)$ (n = 2, 3, 4...)	$90 + 50 (n-2)$ (n = 2, 4, 6, 8... Note 1)	$100 + 50 (n-2)$ (n = 2, 4, 6, 8... Note 1)	$110 + 50 (n-2)$ (n = 2, 4, 6, 8... Note 1)	
1	15	90	100	110			

Note 1) When "n" is an odd number, an even number that is one larger than this odd number is used for the calculation.  
 Note 2) When "n" is an odd number, a multiple of 4 that is larger than this odd number is used for the calculation.

## Minimum Stroke for Auto Switch Mounting

			n: Number of auto switches (mm)				
Auto switch model	Number of auto switches	Brackets other than center trunnion	Center trunnion				
			ø40	ø50	ø63	ø80	ø100
D-G39 D-K39 D-A3□	2	Different surfaces	35	75	80	90	
		Same surface	100	100	100	100	
	n	Different surfaces	$35 + 30(n-2)$ (n = 2, 3, 4...)	$75 + 30(n-2)$ (n = 2, 4, 6, 8...) <sup>Note 1</sup>	$80 + 30(n-2)$ (n = 2, 4, 6, 8...) <sup>Note 1</sup>	$90 + 30(n-2)$ (n = 2, 4, 6, 8...) <sup>Note 1</sup>	
		Same surface	$100 + 100(n-2)$ (n = 2, 3, 4...)		$100 + 100(n-2)$ (n = 2, 4, 6, 8...) <sup>Note 1</sup>		
	1	10	75	80	90		
D-A44	2	Different surfaces	35	75	80	90	
		Same surface	55				
	n	Different surfaces	$35 + 30(n-2)$ (n = 2, 3, 4...)	$75 + 30(n-2)$ (n = 2, 4, 6, 8...) <sup>Note 1</sup>	$80 + 30(n-2)$ (n = 2, 4, 6, 8...) <sup>Note 1</sup>	$90 + 30(n-2)$ (n = 2, 4, 6, 8...) <sup>Note 1</sup>	
		Same surface	$55 + 50(n-2)$ (n = 2, 3, 4...)	$75 + 50(n-2)$ (n = 2, 4, 6, 8...) <sup>Note 1</sup>	$80 + 50(n-2)$ (n = 2, 4, 6, 8...) <sup>Note 1</sup>	$90 + 50(n-2)$ (n = 2, 4, 6, 8...) <sup>Note 1</sup>	
	1	10	75	80	90		
D-G39C D-K39C D-A3□C	2	Different surfaces	20	75	80	90	
		Same surface	100	100	100	100	
	n	Different surfaces	$20 + 35(n-2)$ (n = 2, 3, 4...)	$75 + 35(n-2)$ (n = 2, 4, 6, 8...) <sup>Note 1</sup>	$80 + 35(n-2)$ (n = 2, 4, 6, 8...) <sup>Note 1</sup>	$90 + 35(n-2)$ (n = 2, 4, 6, 8...) <sup>Note 1</sup>	
		Same surface	$100 + 100(n-2)$ (n = 2, 3, 4, 5...)		$100 + 100(n-2)$ (n = 2, 4, 6, 8...) <sup>Note 1</sup>		
	1	10	75	80	90		
D-A44C	2	Different surfaces	20	75	80	90	
		Same surface	55	75	80	90	
	n	Different surfaces	$20 + 35(n-2)$ (n = 2, 3, 4...)	$75 + 35(n-2)$ (n = 2, 4, 6, 8...) <sup>Note 1</sup>	$80 + 35(n-2)$ (n = 2, 4, 6, 8...) <sup>Note 1</sup>	$90 + 35(n-2)$ (n = 2, 4, 6, 8...) <sup>Note 1</sup>	
		Same surface	$55 + 50(n-2)$ (n = 2, 3, 4...)	$75 + 50(n-2)$ (n = 2, 4, 6, 8...) <sup>Note 1</sup>	$80 + 50(n-2)$ (n = 2, 4, 6, 8...) <sup>Note 1</sup>	$90 + 50(n-2)$ (n = 2, 4, 6, 8...) <sup>Note 1</sup>	
	1	10	75	80	90		
D-Y59□/Y7P D-Y7□W D-Z7□/Z80	2 (Different surfaces and same surface) 1	15	80	85	90	95	105
	n	$15 + 40 \frac{(n-2)}{2}$ (n = 2, 4, 6, 8...) <sup>Note 1</sup>	$80 + 40 \frac{(n-4)}{2}$ (n = 4, 8, 12, 16...) <sup>Note 2</sup>	$85 + 40 \frac{(n-4)}{2}$ (n = 4, 8, 12, 16...) <sup>Note 2</sup>	$90 + 40 \frac{(n-4)}{2}$ (n = 4, 8, 12, 16...) <sup>Note 2</sup>	$95 + 40 \frac{(n-4)}{2}$ (n = 4, 8, 12, 16...) <sup>Note 2</sup>	$105 + 40 \frac{(n-4)}{2}$ (n = 4, 8, 12, 16...) <sup>Note 2</sup>
D-Y69□/Y7PV D-Y7□WV	2 (Different surfaces and same surface) 1	10	65	75	80	90	
	n	$10 + 30 \frac{(n-2)}{2}$ (n = 2, 4, 6, 8...) <sup>Note 1</sup>	$65 + 30 \frac{(n-4)}{2}$ (n = 4, 8, 12, 16...) <sup>Note 2</sup>	$75 + 30 \frac{(n-4)}{2}$ (n = 4, 8, 12, 16...) <sup>Note 2</sup>	$80 + 30 \frac{(n-4)}{2}$ (n = 4, 8, 12, 16...) <sup>Note 2</sup>	$90 + 30 \frac{(n-4)}{2}$ (n = 4, 8, 12, 16...) <sup>Note 2</sup>	
D-Y7BA	2 (Different surfaces and same surface) 1	20	95	100	105	110	
	n	$20 + 45 \frac{(n-2)}{2}$ (n = 2, 4, 6, 8...) <sup>Note 1</sup>	$95 + 45 \frac{(n-4)}{2}$ (n = 4, 8, 12, 16...) <sup>Note 2</sup>	$100 + 45 \frac{(n-4)}{2}$ (n = 4, 8, 12, 16...) <sup>Note 2</sup>	$105 + 45 \frac{(n-4)}{2}$ (n = 4, 8, 12, 16...) <sup>Note 2</sup>	$110 + 45 \frac{(n-4)}{2}$ (n = 4, 8, 12, 16...) <sup>Note 2</sup>	
D-P3DWA	2 (Different surfaces and same surface) 1	15		85			
	n	$15 + 50 \frac{(n-2)}{2}$ (n = 2, 4, 6, 8...) <sup>Note 1</sup>		$85 + 50 \frac{(n-4)}{2}$ (n = 4, 8, 12, 16...) <sup>Note 2</sup>			
D-P4DW	2 (Different surfaces and same surface) 1	15	120	130	140		
	n	$15 + 65 \frac{(n-2)}{2}$ (n = 2, 4, 6, 8...) <sup>Note 1</sup>	$120 + 65 \frac{(n-4)}{2}$ (n = 4, 8, 12, 16...) <sup>Note 2</sup>	$130 + 65 \frac{(n-4)}{2}$ (n = 4, 8, 12, 16...) <sup>Note 2</sup>	$140 + 65 \frac{(n-4)}{2}$ (n = 4, 8, 12, 16...) <sup>Note 2</sup>		

Note 1) When "n" is an odd number, an even number that is one larger than this odd number is used for the calculation.

Note 2) When "n" is an odd number, a multiple of 4 that is larger than this odd number is used for the calculation.

## Auto Switch Mounting Brackets/Part No.

### <Tie-rod mounting>

Auto switch model	Bore size (mm)				
	40	50	63	80	100
D-M9□/M9□V D-M9□W/M9□WV D-M9□A/M9□AV D-A9□/A9□V	BA7-040	BA7-040	BA7-063	BA7-080	BA7-080
D-F5□/J59 D-F5□W/J59W D-F59F/F5NT D-A5□/A6□ D-A59W	BT-04	BT-04	BT-06	BT-08	BT-08
D-G39C/K39C D-A3□C/A44C	BA3-040	BA3-050	BA3-063	BA3-080	BA3-100
D-Y59□/Y69□ D-Y7P/Y7PV D-Y7□W/Y7□WV D-Y7BA D-Z7□/Z80	BA4-040	BA4-040	BA4-063	BA4-080	BA4-080
D-P3DWA	BK7-040S	BK7-040S	BA10-063S	BA10-080S	BA10-080S
D-P4DW	BAP2-040	BAP2-040	BAP2-063	BAP2-080	BAP2-080

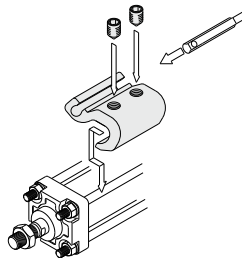

\* The figure shows the mounting example for the D-M9□(V)/M9□W(V)/M9□A(V)/A9□(V) types.

### <Band mounting>

#### Except air-hydro type

Auto switch model	Bore size (mm)				
	40	50	63	80	100
D-G39/K39 D-A3□/A44	BDS-04M	BDS-05M	BMB1-063	BMB1-080	BMB1-100
D-G5□/K59 D-G5□W/K59W D-G59F D-G5NT D-B5□/B64 D-B59W	BH2-040	BA5-050	BAF-06	BAF-08	BAF-10

Note 1) Auto switch brackets are included in the D-A3□C/A44C/G39C/K39C types. Specify the part number as follows depending on the cylinder size when ordering.  
(Example) ø40: D-A3□C-4, ø50: D-A3□C-5, ø63: D-A3□C-6, ø80: D-A3□C-8, ø100: D-A3□C-10

#### [Stainless Steel Mounting Screw]

The following stainless steel mounting screw kit (including set screws) is also available. Use it in accordance with the operating environment.  
(Since the auto switch mounting bracket and band are not included, order them separately.)

- BBA1: For D-A5/A6/F5/J5 types
- BBA3: For D-B5/B6/G5/K5 types

Note 2) Refer to pages 1369 and 1377 for details on the BBA1 and BBA3.

The above stainless steel screws are used when a cylinder is shipped with D-F5BA or G5BA auto switches. When only an auto switch is shipped independently, the BBA1 or BBA3 is attached.

Note 3) When using the D-M9□A(V) or Y7BA, do not use the steel set screws which are included with the above auto switch mounting brackets (BA7-□□□, BA4-□□□). Order a stainless steel screw kit (BBA1) separately, and use the M4 x 6 L stainless steel set screws included in the BBA1.

Note 4) There is a difference in the cylinder tube thickness depending on the cylinder model. Use caution when a band mounting type is used as an applicable auto switch and a cylinder model is changed.

### Air-hydro type

Auto switch model	Bore size (mm)				
	40	50	63	80	100
D-G39/K39 D-A3□/A44	BD1-04M	BD1-05M	BD1-06M	BD1-08M	BD1-10M
D-G5□/K59 D-G5□W/K59W D-G59F D-G5NT D-B5□/B64 D-B59W	BA-04	BA-05	BA-06	BA-08	BA-10

### Other than the applicable auto switches listed in "How to Order", the following auto switches are mountable.

Refer to pages 1271 to 1365 for the detailed specifications.

Type	Model	Electrical entry	Features	
Solid state	D-M9NV/M9PV/M9BV D-Y69A/Y69B/Y7PV D-M9NWV/M9PWV/M9BWW D-Y7NWW/Y7PWW/Y7BWW D-M9NAV/M9PAV/M9BAV	Grommet (Perpendicular)	—	
	D-Y59A/Y59B/Y7P D-F59/F5P/J59 D-Y7NW/Y7PW/Y7BW		Diagnostic indication (2-color indicator)	
	D-F59W/F5PW/J59W D-F5BA/Y7BA D-F5NT/G5NT		Grommet (In-line)	Water resistant (2-color indicator)
	D-P5DW		With timer	
	D-A93V/A96V D-A90V		Grommet (Perpendicular)	Magnetic field resistant (2-color indicator)
	D-A53/A56/B53/Z73/Z76 D-A67/Z80	Grommet (In-line)	Without indicator light	

\* With pre-wired connector is also available for solid state auto switches. For details, refer to pages 1340 and 1341.

\* Normally closed (NC = b contact) solid state auto switches (D-M9□E(V)/Y7G/Y7H) are also available. For details, refer to pages 1290 and 1292.



## 1 Cylinder with Heat Resistant Reed Auto Switch (-10 to 120°C)

Symbol  
**-X1184**

### Applicable Series

Description	Model	Action	Note
Standard type	CA2	Double acting, Single rod	

### How to Order

CDA2  Z -   -   - X1184

Switch model	
Symbol	Description
Nil	Without switch
B30	D-B30
B30J	D-B30J
B31	D-B31
B31J	D-B31J
B35	D-B35
B35J	D-B35J

Number of switches	
Symbol	Description
S	1 pc.
Nil	2 pcs.

Cylinder with heat resistant reed auto switch

\* For details about auto switches, refer to pages 1363 to 1365.

### Specifications

Ambient temperature range	-10°C to 120°C
Seal material	Fluororubber
Grease	Heat resistant grease

### Warning Precautions

Be aware that smoking cigarettes etc. after your hands have come into contact with the grease used in this cylinder can create a gas that is hazardous to humans.

### Dimensions (Dimensions other than below are the same as standard type.)

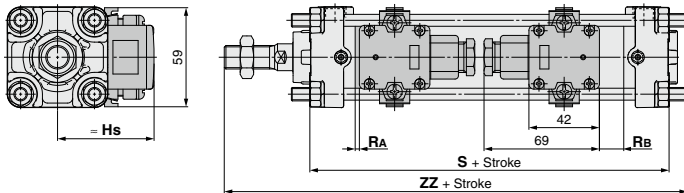

(mm)

Bore size	Hs	RA	RB	S	ZZ	Minimum mounting stroke		Auto switch mounting bracket part number
						Other than center trunnion	Center trunnion	
40	57.5	4	13	99	161	1 pc.: 50 st or more	180 st or more	BD1-04M
50	62.5	4	13	105	174		180 st or more	BD1-05M
63	69	7	16	113	185	2 pcs.: Different surfaces 50 st or more	190 st or more	BD1-06M
80	78	5.5	23.5	131	219		200 st or more	BD1-08M
100	88.5	7.5	25.5	141	230	2 pcs.: Same surface 220 st or more	210 st or more	BD1-10M