

Compendium of JSI Series

JSI Standard cylinder
Bore size: 32, 40, 50, 63, 80, 100, 125

Adjustable air buffer
With adjustable air buffer on the front and back cover

No tie rod cylinder
The cylinder barrel is aluminum profile with hard anodizing treatment.

Convenient and fast fix sensor switch
With sensor switch groove on the two sides of body, the counterpart sensor switch type is: CMSE \ DMSE.

Four kinds of cylinder joints
I Knuckle Y Knuckle Floating Joint Universal Joint

Multi-mounting accessories
LB FA FB CA CB CR TC TCM1 TCM2

Multi-type cylinder
JSI: Double acting type JSID: Double rod type JSIJ: Adjustable stroke type

Criteria for selection: Cylinder thrust

Unit : Newton(N)

Bore size	Rod size	Acting type	Pressure area(mm ²)	Operating pressure(MPa)								
				0.1	0.2	0.3	0.4	0.5	0.6	0.7	0.8	0.9
32	12	Double acting Push side	804	80.4	160.8	241.2	321.6	402.0	482.4	562.8	643.2	723.6
		Pull side	690	69.0	138.0	207.0	276.0	345.0	414.0	483.0	552.0	621.0
40	16	Double acting Push side	1256	125.6	251.2	376.8	502.4	628.0	753.6	879.2	1002.4	1130.4
		Pull side	1055	105.5	211.0	316.5	422.0	527.5	633.0	738.5	844.0	949.5
50	20	Double acting Push side	1963	196.3	392.6	588.9	785.2	981.5	1177.8	1374.1	1570.4	1766.7
		Pull side	1649	164.9	329.8	494.7	659.6	824.5	989.4	1154.3	1399.2	1484.1
63	20	Double acting Push side	3117	311.7	623.4	935.1	1246.8	1558.5	1870.2	2181.9	2493.6	2805.3
		Pull side	2803	280.3	560.6	840.9	1121.2	1401.5	1681.8	1962.1	2242.4	2522.7
80	25	Double acting Push side	5026	502.6	1005.2	1507.8	2010.4	2513.0	3015.6	3518.2	4020.8	4523.4
		Pull side	4536	453.6	907.2	1360.8	1814.4	2268.0	2721.6	3175.2	3628.8	4082.4
100	32	Double acting Push side	7853	785.3	1570.6	2355.9	3141.2	3926.5	4711.8	5497.1	6282.4	7067.7
		Pull side	7147	714.7	1429.4	2144.1	2858.9	3573.6	4288.3	5003.0	5717.7	6432.4
125	32	Double acting Push side	12272	1227.2	2454.4	3681.6	4908.8	6136.0	7363.2	8590.4	9817.6	11044.8
		Pull side	11468	1146.8	2293.6	3440.4	4587.2	5734.0	6880.8	8027.6	9174.4	10321.2

Installation and application



- When load changes in the work, the cylinder with abundant output capacity shall be selected.
- Relative cylinder with high temperature resistance or corrosion resistance shall be chosen under the condition of high temperature or corrosion.
- Necessary protection measure shall be taken in the environment with higher humidity, much dust or water drops, oil dust and welding dregs.
- Dirty substances in the pipe must be eliminated before cylinder is connected with pipeline to prevent the entrance of particles into the cylinder.
- The medium used by cylinder shall be filtered to 40μm or below.
- Anti-freezing measure shall be adopted under low temperature environment to prevent moisture freezing.
- The cylinder shall be carried out test run without load before application. Prior to run, buffer shall be turned to the minimum and gradually released to avoid the damage on cylinder caused by excessive impact.
- The cylinder shall avoid the influence of side load in operation to maintain the normal work of cylinder and extend the service life.
- If the cylinder is dismantled and stored for a long time, please conduct anti-rust treatment to the surface. Anti-dust caps shall be added in air inlet and outlet ports.

Standard cylinder

JSI Series



Specification

Bore size(mm)	32	40	50	63	80	100	125
Acting type	Double acting						
Fluid	Air (to be filtered by 40µm filter element)						
Mounting type	JSI	Basic FA FB CA CB CR LB TC TCM1 TCM2					
	JSID, JSIJ	Basic FA LB TC TCM1 TCM2					
Operating pressure	0.15~1.0MPa(22~145psi)(1.5~10.0bar)						
Proof pressure	1.5MPa(215psi)(15bar)						
Temperature °C	-20~70						
Speed range mm/s	30~800						30~500
Stroke tolerance	0~250 ^{+1.0} ₀		251~1000 ^{+1.5} ₀		1001~1500 ^{+2.0} ₀		
Cushion type	Variable cushion						
Adjustable cushion stroke	20		20.5		29		33
Port size [Note1]	1/8"		1/4"		3/8"		1/2"

[Note1] PT thread, G thread are available. Add) Refer to P362 for detail of sensor switch.

Symbol

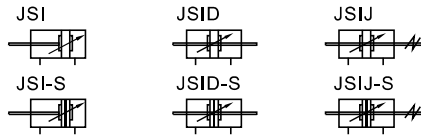

Product feature

1. JIS standard cylinder.
2. The seal of piston adopts heterogeneous two way seal structure. It's dimension is tight and it has the function of greasel reservation.
3. The cylinder barrel is aluminum profile with hard anodizing treatment.
4. Compared with ISO15552 standard cylinder, the cylinder of JSI series with the same cylinder diameter is shorter.
5. The buffer adjustment of cylinder is smooth and steady.
6. Cylinders and mounting accessories for installation with several specifications are optional.

Stroke

Bore size (mm)	Standard stroke (mm)												Max.std stroke	Max. stroke									
32	25	50	75	80	100	125	150	160	175	200	250	300	350	400	450	500	1000	1800					
40	25	50	75	80	100	125	150	160	175	200	250	300	350	400	450	500	600	700	800	900	1000	1200	1800
50	25	50	75	80	100	125	150	160	175	200	250	300	350	400	450	500	600	700	800	900	1000	1200	1800
63	25	50	75	80	100	125	150	160	175	200	250	300	350	400	450	500	600	700	800	900	1000	1500	1800
80	25	50	75	80	100	125	150	160	175	200	250	300	350	400	450	500	600	700	800	900	1000	1500	1800
100	25	50	75	80	100	125	150	160	175	200	250	300	350	400	450	500	600	700	800	900	1000	1500	1800
125	25	50	75	80	100	125	150	160	175	200	250	300	350	400	450	500	600	700	800	900	1000	1500	1800

[Note] Consult us for non-standard stroke.

Ordering code

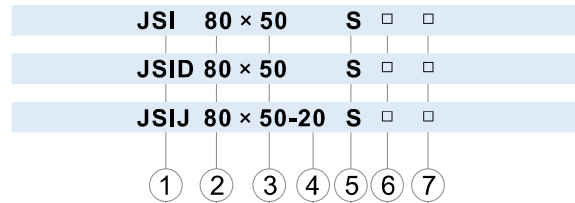

① Model	② Bore size	③ Stroke	④ Adjustable stroke	⑤ Magnet	⑥ Mounting type [Note1]	⑦ Thread type
JSI: Double acting type	32 40 50 63 80 100 125	Refer to stroke table for details	No this code	Blank: Without magnet S: With magnet	Blank	Blank: PT G: G
					LB	
FA						
FB						
CA						
CB						
CR						
TC						
Blank						
LB						
FA						
TC						

[Note1] Please refer to page 54~56 for details of accessories ; TC is used with TCM1, TCM2.

Standard cylinder

JSI Series

Inner structure and material of major parts

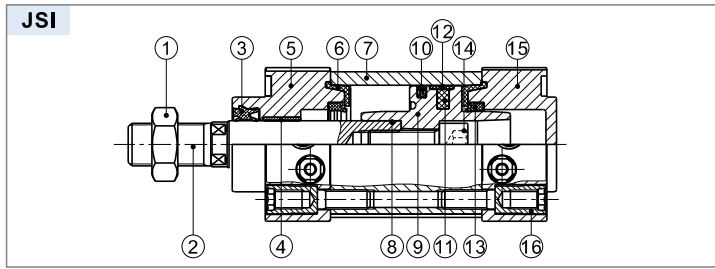

NO.	Item	Material
1	Rod nut	Carbon steel
2	Piston rod	Carbon steel with 20μm chrome plated or Stainless steel
3	Front cover packing	TPU
4	Bushing	Wear resistant material
5	Front cover	Aluminum alloy
6	O-ring	TPU
7	Barrel	Aluminum alloy
8	O-ring	NBR
9	Piston	Aluminum alloy
10	Piston seal	NBR
11	Magnet	Plastic
12	Wear ring	Wear resistant material
13	Buffer gasket	TPU
14	Screw	Carbon steel
15	Back cover	Aluminum alloy
16	Tie-rod nut	Carbon steel

Dimensions

JSI

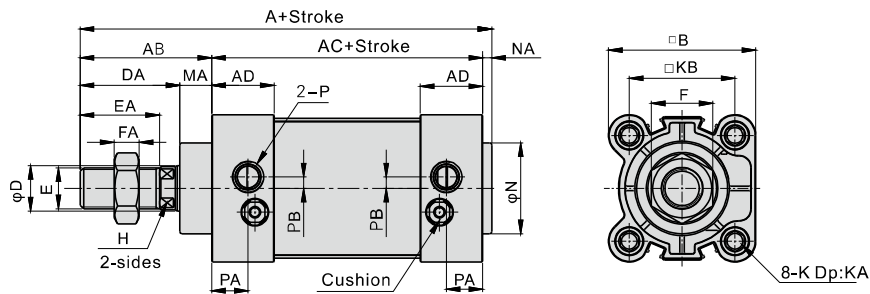

Bore size\Item	A	AB	AC	AD	B	D	DA	E	EA	F	FA	H	M	MA	K	KA	KB	N	NA	P	PA	PB
32	135	47	84	26	47	12	34	M10×1.25	22	17	6	10	30	13	M6	16	32.5	30	4	1/8"	13	5.5
40	139	51	84	25	53	16	38	M14×1.5	30	19	8	14	35	13	M6	16	38	35	4	1/4"	14	6
50	156	58	94	27.5	65	20	44	M18×1.5	35	27	11	18	40	14	M8	16	46.5	40	4	1/4"	16	5
63	156	58	94	27.5	75	20	44	M18×1.5	35	27	11	18	45	14	M8	16	56.5	45	4	3/8"	15	9
80	190	72	114	35	95	25	52	M22×1.5	40	32	13	22	45	20	M10	18	72	45	4	3/8"	19	11.5
100	190	72	114	35	115	32	52	M26×1.5	40	36	13	27	55	20	M10	18	89	55	4	1/2"	19	17
125	223	97	120	37.5	140	32	70	M27×2	54	41	13.5	27	60	27	M12	22	110	60	6	1/2"	20	17

Remark: The dimensions of magnet type cylinder are the same as non-magnet type cylinder.

JSID

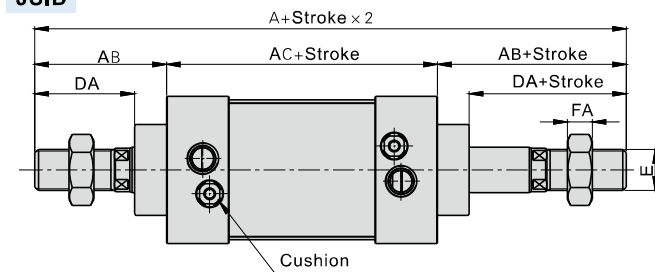

JSIJ

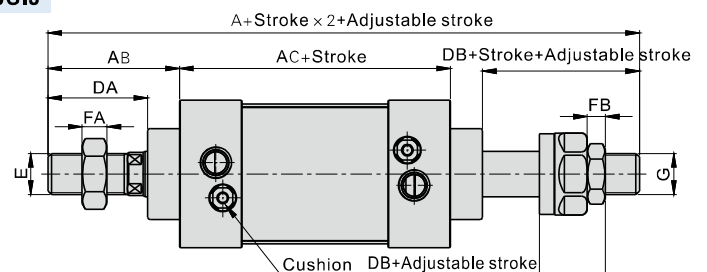

Bore size\Item	A(JSID)	A(JSIJ)	AB	AC	DA	DB	E	FA	FB	G
32	178	171	47	84	34	27	M10X1.25	6	6	M10X1.25
40	186	176	51	84	38	28	M14X1.5	8	7	M12X1.25
50	210	195	58	94	44	29	M18X1.5	11	8	M16X1.5
63	210	195	58	94	44	29	M18X1.5	11	8	M16X1.5
80	258	241.5	72	114	52	35.5	M22X1.5	13	10	M20X1.5
100	258	248.5	72	114	52	42.5	M26X1.5	13	13.5	M27X2.0
125	314	286.5	97	120	70	42.5	M27X2.0	13.5	13.5	M27X2.0

Remark:

- The dimensions of magnet type cylinder are the same as non-magnet type cylinder.
- The unmarked dimension is the same as JSI standard type.

Standard cylinder

JSI Series—Accessories

List for ordering code of accessories

Accessories Bore size	Mounting accessories							
	LB	FA/FB	CA	CB	CR	TC	TCM1	TCM2
32	F-JSI32LB	F-SI32FA	F-JSI32CA	F-JSI32CB	F-JSI32CR	F-SAI32TC	F-SI32TCM1	F-SI32TCM2
40	F-JSI40LB	F-SI40FA	F-JSI40CA	F-JSI40CB	F-JSI32CR	F-SAI40TC	F-SI40TCM1	F-SI40TCM2
50	F-JSI50LB	F-SI50FA	F-JSI50CA	F-JSI50CB	F-JSI50CR	F-SAI50TC	F-SI40TCM1	F-SI40TCM2
63	F-JSI63LB	F-SI63FA	F-JSI63CA	F-JSI63CB	F-JSI50CR	F-SAI63TC	F-SI63TCM1	F-SI63TCM2
80	F-JSI80LB	F-SI80FA	F-JSI80CA	F-JSI80CB	F-JSI80CR	F-SAI80TC	F-SI63TCM1	F-SI63TCM2
100	F-JSI100LB	F-SI100FA	F-JSI100CA	F-JSI100CB	F-JSI80CR	F-SAI100TC	F-SI125TCM1	F-SI125TCM2
125	F-JSI125LB	F-JSI125FA	F-JSI125CA	F-JSI125CB	F-JSI125CR	F-SAI125TC	F-SI125TCM1	F-SI125TCM2

Accessories Bore size	Knuckle				Sensor	
	I : I Knuckle	Y : Y Knuckle	F : F Knuckle	U : U Knuckle	CMSE	DMSE
32	F-M10X125I	F-M10X125Y	F-M10X125F	F-M10X125U	CMSE	DMSE
40	F-M14X150I	F-M14X150Y	F-M14X150F	F-M14X150U		
50	F-M18X150I	F-M18X150Y	F-M18X150F	F-M18X150U		
63	F-M18X150I	F-M18X150Y	F-M18X150F	F-M18X150U		
80	F-M22X150I	F-M22X150Y	F-M22X150F	-		
100	F-M26X150I	F-M26X150Y	F-M26X150F	F-M26X150U		
125	F-M27X200I	F-M27X200Y	F-M27X200F	F-M27X200U		

Accessory selection

Accessories Cylinder model	Mounting accessories										Knuckle [Note1]				Sensor	
	LB	FA	FB	CA	CB	CR	TC	TCM1	TCM2	I	Y	U	F	CMSE	DMSE	
JSI	Standard	●	●	●	●	●	●	●	●	●	●	●	●	●	●	
	With magnet	●	●	●	●	●	●	●	●	●	●	●	●	●	●	
JSID	Standard	●	●	x	x	x	x	●	●	●	●	●	●	x	x	
	With magnet	●	●	x	x	x	x	●	●	●	●	●	●	●	●	
JSIJ	Standard	●	●	x	x	x	x	●	●	●	●	●	●	x	x	
	With magnet	●	●	x	x	x	x	●	●	●	●	●	●	●	●	

[Note1] Please refer to P358~361 for knuckle detail.

Material of accessories

Accessories Bore size	Mounting accessories										Knuckle			
	LB	FA	FB	CA	CB	CR	TC	TCM1	TCM2	I	Y	F	U	
32-63	△	●	●	◇	◇	◇	◇	◇	◇	●	□	□	□	
80, 100	△	●	●	◇	◇	◇	◇	◇	◇	●	□	□	□	
125	◇	◇	◇	◇	◇	◇	◇	◇	◇	●	◇	◇	□	

●—Aluminum alloy, ◇—Nodular cast iron, □—Carbon steel, △—SPCC.

Dimensions

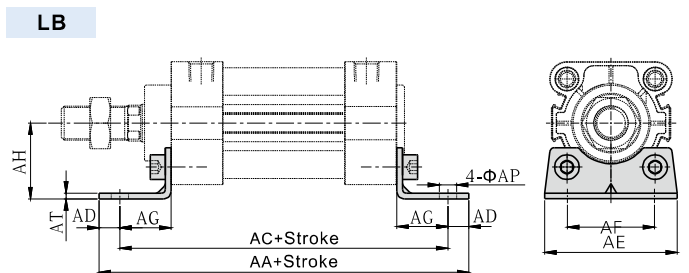

Bore size\Item	AA	AC	AD	AE	AF	AG	AH	AP	AT
32	146	128	9	50	32	22	30	7	3
40	154	132	11	55	38	24	33	9	3
50	170	148	11	70	46	27	40	9	3
63	176	148	14	80	56	27	45	12	4
80	202	174	14	100	72	30	55	12	5
100	210	178	16	120	89	32	65	14	5
125	250	210	20	136	90	45	81	14	8

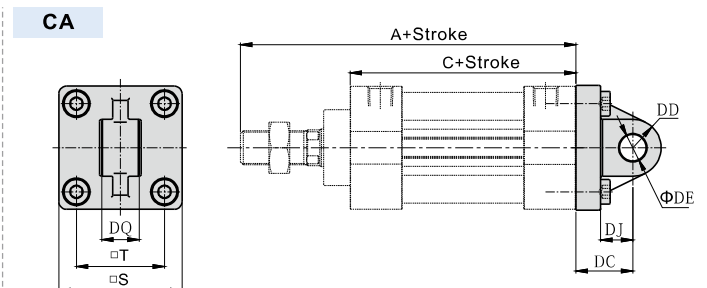

Bore size\Item	A	C	S	T	DC	DD	DE	DJ	DQ
32	131	84	46	32.5	23	10.5	10	13	13.8
40	135	84	52	38	23	11	10	13	13.8
50	152	94	65	46.5	30	15	14	17	19.8
63	152	94	75	56.5	30	15	14	17	19.8
80	186	114	95	72	42	17.5	22	27	29.8
100	186	114	114	89	42	17.5	22	27	29.8
125	217	120	136	110	50	28	25	28	31.8

Standard cylinder

JSI Series—Accessories

TCM1

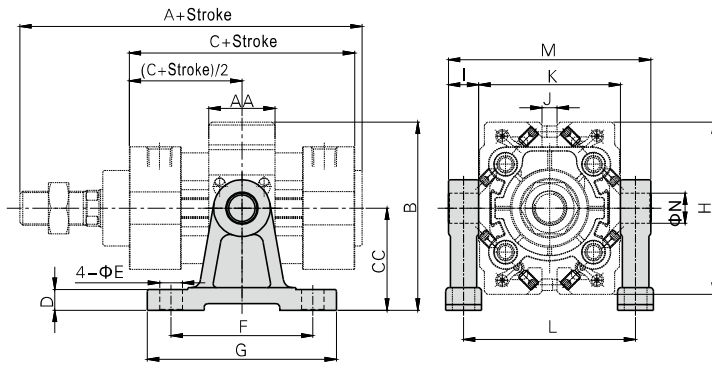

TCM2

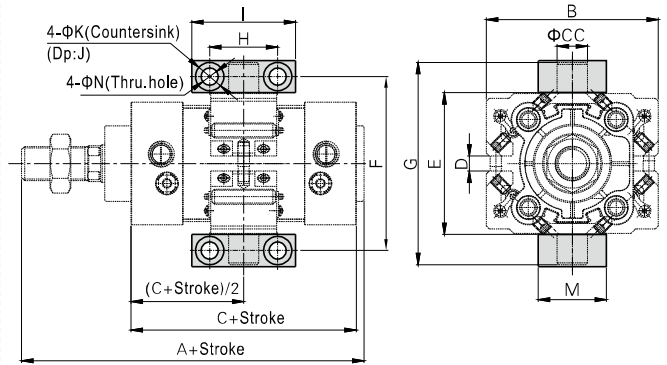

Bore size\Item	A	AA	B	C	CC	D	E	F	G	H	I	J	K	L	M	N
32	135	31	72.5	84	40	11	9	60	80	65	12	5	52	60	79	12
40	139	31	91.5	84	54	11	12	75	100	75	16	8	63	79	98	16
50	156	35	99.5	94	54	11	12	75	100	91	16	10	75	91	110	16
63	156	35	121.5	94	70	11	12	85	110	103	20	16	90	110	133	20
80	190	45	133	114	70	11	12	85	110	126	20	20	110	130	153	20
100	190	45	162.5	114	90	19	18	115	155	145	25	28	132	157	185	25
125	223	51	177.5	120	90	19	18	115	155	175	25	40	160	185	213	25

Bore size\Item	A	B	C	CC	D	E	F	G	H	I	J	K	M	N
32	135	65	84	12	5	52	68	82	32	46	6.8	11	30	7
40	139	75	84	16	8	63	82	99	36	55	9	15	36	9
50	156	91	94	16	10	75	94	111	36	55	9	15	36	9
63	156	103	94	20	16	90	113.5	134	42	65	11	18	40	11
80	190	126	114	20	20	110	133.5	154	42	65	11	18	40	11
100	190	145	114	25	28	132	159.5	184	50	75	14	20	50	14
125	223	175	120	25	40	160	187.5	212	50	75	14	20	50	14