

Motor controllers CMMS-ST, for stepper motors

FESTO

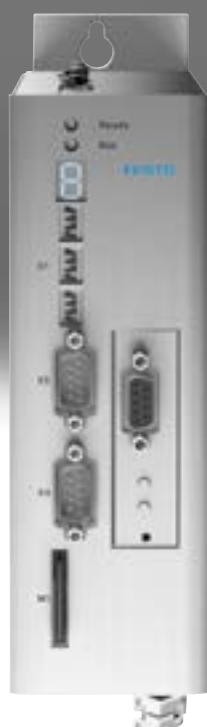

Key features

Features

Compactness

- Small dimensions
- Full integration of all components for the controller and power section, including RS232 and CANopen interface
- Integrated brake chopper
- Integrated EMC filters
- Automatic actuation for a holding brake
- Complies with the current CE and EN standards without additional external measures (motor cable length of up to 15 m)

Bus protocols

Integrated:



Optional:



Safety functions

- The motor controller CMMS-ST supports the "safe torque off (STO)" safety function and, by providing a reliable time delay, also supports "safe stop 1 (SS1)" with protection against unexpected start-up in accordance with the requirements of EN 61800-5-2
- Protection against unexpected start-up
- Two-channel shutdown of the power stage
- Shorter response times in the event of an error

Servo mode

- Encoder option (closed loop), in other words no step losses, following errors are corrected

Motion control

- Can be operated as a torque, rotational speed or position controller
- Integrated positioning control
- Time-optimised (trapezoidal) or jerk-free (S-shaped) positioning
- Absolute and relative movements
- Point-to-point positioning with and without motion path smoothing
- Position synchronisation
- Electronic gear unit
- 63 position sets
- 8 positioning profiles
- Wide range of homing methods

Input/output

- Freely programmable I/Os
- High-resolution 12-bit analogue input
- Jog/teach mode
- Easy connection to a higher-order controller via I/O or fieldbus
- Synchronous operation
- Master/slave mode

Integrated sequence control

- Automatic sequence of position sets without a higher-order controller
- Linear and cyclical position sequences
- Adjustable delay times

Interpolating multi-axis movement

- With a suitable controller, the CMMS-ST can perform path movements with interpolation via CANopen. To do this, the controller specifies setpoint position values in a fixed time pattern. In between, the servo position controller independently interpolates the data values between two interpolation points.

Key features

Motion program

- Linking any number of position sets into a motion program
- Step enabling conditions for the motion program possible via digital inputs, for example
MC – motion complete
I/O – digital inputs

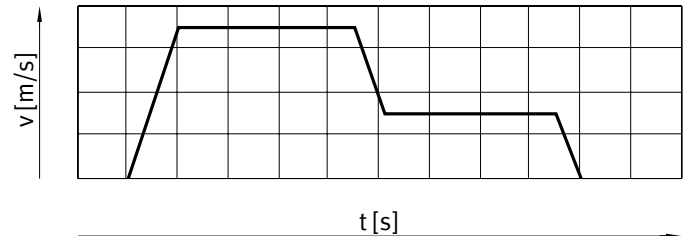
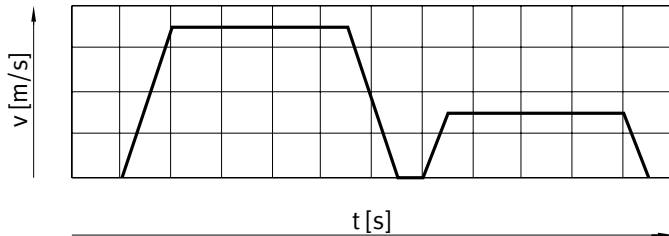

Library for EPLAN

→ www.festo.de/eplan



EPLAN macros for fast and reliable planning of electrical projects in combination with motor controllers, motors and cables. This enables a high level of planning reliability and standardisation of documentation without the need to create symbols, graphics and master data.

FHPP – Festo Handling and Positioning Profile

Optimised data profile

Festo has developed an optimised data profile, the "Festo Handling and Positioning Profile (FHPP)", which is specifically tailored to handling and positioning applications.

With the FHPP data profile, Festo motor controllers can be controlled using a fieldbus interface via standardised control and status bytes.

The following are defined, among others:

- Operating modes
- I/O data structure
- Parameter objects
- Sequence control

Type codes

001	Series
CMMS	Motor controller, standard

002	Motor type
ST	Stepper motor ST

003	Nominal current
C8	8 A

004	Nominal input voltage
7	48 V DC

005	Generation
G2	2nd generation

Datasheet

Bus protocols



General technical data

Type of mounting	Screwed onto connection plate
Operating mode	PWM MOSFET power output stage
Mode of operation	Microstepping, > 4000 steps/rev
Motor control	Sinusoidal current injection
Cycle rate [kHz]	Constant 50
Rotor position sensor	Encoder
Display	7-segment display
Parameterisation interface	RS232 (9600 ... 115,000 bits/s)
Encoder interface input	As speed/position specification for the slave drive in synchronous mode RS422
Encoder interface output	Setpoint specification for downstream slave drive
Braking resistor, integrated [Ω]	17
Pulse power of braking resistor [kVA]	0.5
Bus terminating resistor	Built in
Impedance of setpoint input [k Ω]	20
Number of analogue outputs	1
Operating range of analogue outputs [V]	± 10
Characteristics of digital logic outputs	Freely configurable in some cases
Number of analogue inputs	1
Operating range of analogue inputs [V]	± 10
Mains filter	Built in
Product weight [g]	900

Technical data – Bus protocols/control

Interfaces	I/O	CANopen	PROFIBUS DP	DeviceNet
Communication profile	–	DS301, FHPP	DP-V0/FHPP	FHPP
	–	DS301; DSP402	–	–
Max. fieldbus transmission rate [Mbps]	–	1	12	0.5
Interface	Built in	■	■	–
	Optional	–	–	■ → Page 10

Datasheet

Function blocks for PLC programming				
Programming software	Controller manufacturer	Interfaces		
		CANopen	PROFIBUS DP	DeviceNet
CODESYS TwinCAT	Festo	■	■	■
	Beckhoff			
	Other manufacturers			
RSLogix5000	Rockwell Automation	-	-	■
STEP 7	Siemens	-	■	-

Electrical data		
Output connection data		
Output voltage range		0 V up to input voltage
Nominal current setting		Via software
Max. peak current duration	[s]	2
Max. DC link voltage	[V DC]	48
Output frequency	[Hz]	0 ... 2000
Load supply		
Nominal voltage	[V DC]	24 ... 48
Nominal current	[A]	8
Peak current	[A]	12
Logic supply		
Nominal voltage	[V DC]	24 ±20%
Nominal current	[A]	0.2
Max. current of digital logic outputs	[mA]	100

Safety characteristics	
Safety function to EN 61800-5-2	Safe torque off (STO)
Performance Level (PL) to EN ISO 13849-1	Category 3, Performance Level d
Safety Integrity Level (SIL) to EN 61800-5-2, EN 62061, EN 61508	SIL 2
MTTFd	STO/2521 years
PFH	4.53×10^{-8}
Certification	BIA
Certificate issuing authority	BG MFS 09031
CE marking (see declaration of conformity)	To EU EMC Directive ¹⁾
	To EU Machinery Directive

1) For information about the area of use, see the EC declaration of conformity at: www.festo.com/sp → Certificates.
If the devices are subject to usage restrictions in residential, commercial or light-industrial environments, further measures for the reduction of the emitted interference may be necessary.

Datasheet

Operating and environmental conditions		
Digital logic outputs		Not galvanically isolated
Logic inputs		Galvanically isolated
Degree of protection		IP20
Protective function		I ² t monitoring
		Current monitoring
		Voltage failure detection
		Following error monitoring
		Temperature monitoring
Pollution degree		2
Ambient temperature	[°C]	0 ... +50
Storage temperature	[°C]	-25 ... +70
Relative humidity	[%]	0 ... 90 (non-condensing)
CE marking (see declaration of conformity) ¹⁾		To EU EMC Directive
		To EU Machinery Directive
UKCA marking (see declaration of conformity) ¹⁾		To UK instructions for EMC
		To UK instructions for machines
Certification		c UL us - Listed (OL)
		C-Tick
Note on materials		RoHS-compliant
PWIS conformity		VDMA24364-B2-L

1) For information about the area of use, see the EC declaration of conformity at: www.festo.com/sp → Certificates.

If the devices are subject to usage restrictions in residential, commercial or light-industrial environments, further measures for the reduction of the emitted interference may be necessary.

Datasheet

View of motor controller

From the front

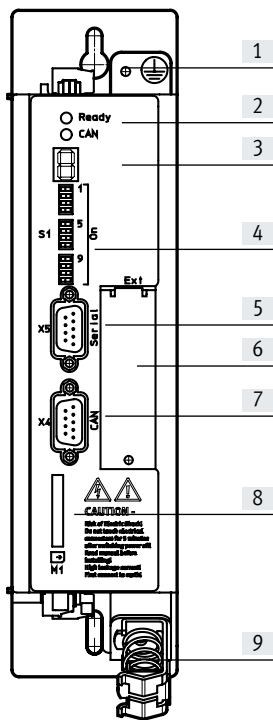

- [1] Earthing
- [2] Ready/bus – LED
- [3] Status indication
- [4] Fieldbus settings and bootloader
- [5] X5 interface: RS232/RS485
- [6] X4 technology module slot
- [7] Interface: CAN bus
- [8] SD memory card
- [9] Shield connection

From above

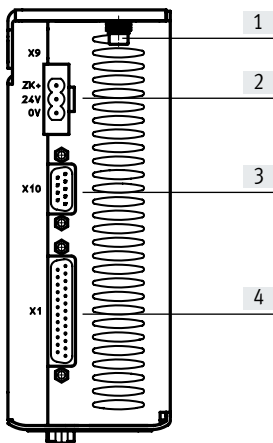

- [1] Earthing screw
- [2] X9 power supply
- [3] X10 incremental encoder interface (bidirectional)
- [4] X1 I/O interface

From underneath

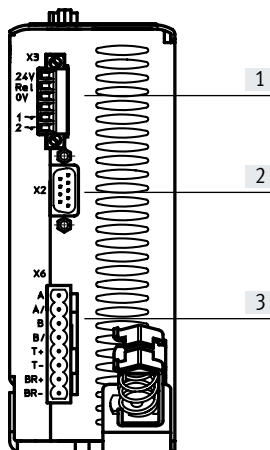

- [1] X3 safe standstill
- [2] X2 incremental encoder input for motor
- [3] X6 motor connection

Datasheet

Installation clearance for motor controller

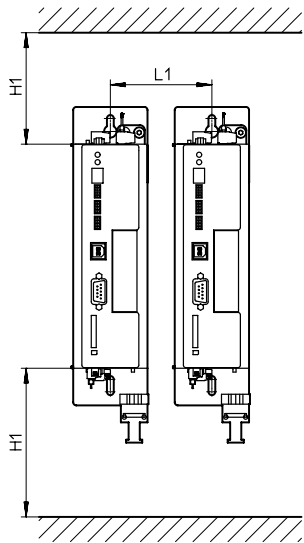

H1	L1
100	69

Dimensions

Download CAD data → www.festo.com

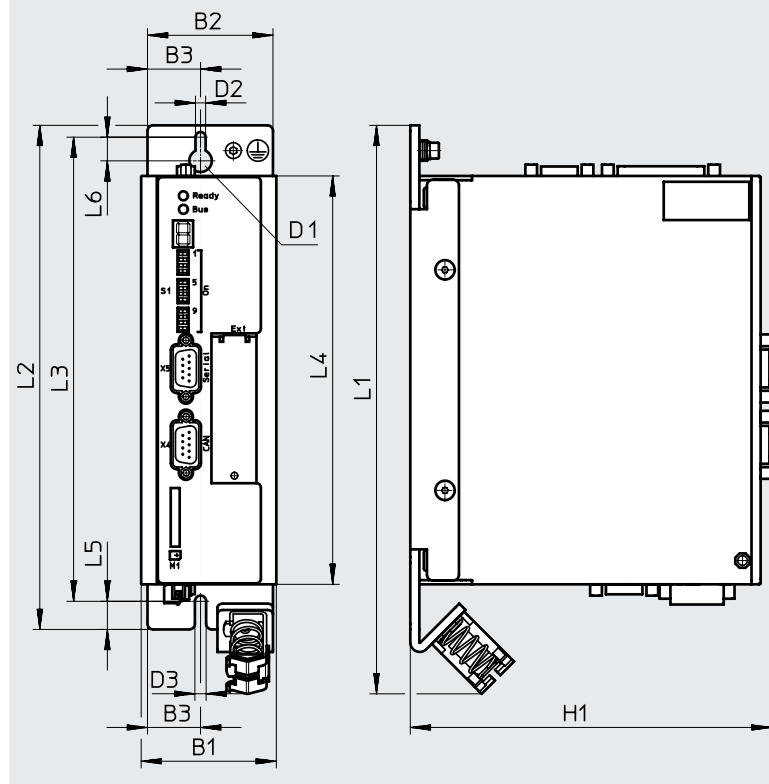

Type	B1	B2	B3	D1	D2	D3	H1
CMMS-ST	60	56	24	10	4.5	5	161

Type	L1	L2	L3	L4	L5	L6
CMMS-ST	252	224	206.25	181	12.5	15.75

Technical data and accessories

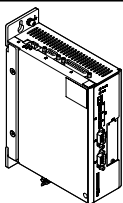

Ordering data		Description	Part no.	Type
		The plug assortment NEKM (→ page 11) is included in the scope of delivery of the motor controller.	572211	CMMS-ST-C8-7-G2

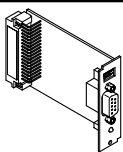
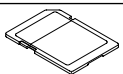
Accessories

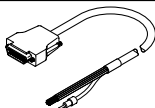
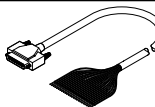
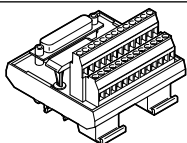
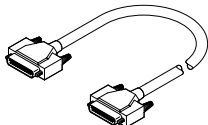
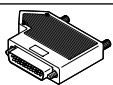
Ordering data – Plug-in cards				
Ordering data		Description	Part no.	Type
		Interface module, for PROFIBUS interface	547450	CAMC-PB
		Interface module, for DeviceNet interface	547451	CAMC-DN
		Memory card, for data backup and firmware download	1436343	CAMC-M-S-F10-V1

Ordering data – Connection options from I/O interface to the controller					
Ordering data		Description	Cable length [m]	Part no.	Type
Control cable					
		<ul style="list-style-type: none"> For I/O interface to any controller Recommended for analogue signals since the cable is shielded 	2.5	552254	NEBC-S1G25-K-2.5-N-LE26
		<ul style="list-style-type: none"> For I/O interface to any controller Cannot be used if the incremental encoder interface (plug X10) is in use 	3.2	8001373	NEBC-S1G25-K-3.2-N-LE25
Connection block					
		Ensures simple and clear wiring. The connection to the motor controller is established via the connecting cable NEBC-S1G25-K...	–	8001371	NEFC-S1G25-C2W25-S7
Connecting cable					
		Connects the motor controller to the connection block	1.0	8001374	NEBC-S1G25-K-1.0-N-S1G25
			2.0	8001375	NEBC-S1G25-K-2.0-N-S1G25
			5.0	8001376	NEBC-S1G25-K-5.0-N-S1G25
Plug					
		25-pin Sub-D plug. Each wire can be individually assembled using screw terminals	–	8001372	NEFC-S1G25-C2W25-S6

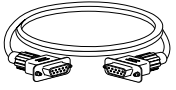
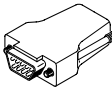
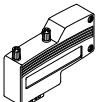
Accessories

Ordering data – Cables and plugs					
	Description	Cable length [m]	Part no.	Type	
Programming cable					
	–	2.0	160786	PS1-ZK11-NULLMODEM-2.0M	
Encoder plug					
	For incremental encoder interface	–	564264	NECC-A-S-S1G9-C2M	
Plug					
	For PROFIBUS interface	–	533780	FBS-SUB-9-WS-PB-K	
	For CANopen interface	–	533783	FBS-SUB-9-WS-CO-K	
	For DeviceNet interface	–	525635	FBSD-KL-2X5POL	

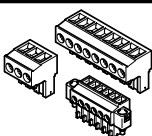
Ordering data – Assortment of plugs			
	Description	Part no.	Type
	<ul style="list-style-type: none"> Comprising plug for power supply, motor connection and safety function The plug assortment is included in the scope of delivery of the motor controller 	547452	NEKM-C-1

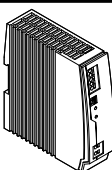
Ordering data – Power supply units						
	Description	Input voltage range [V AC]	Nominal output voltage [V DC]	Nominal output current [A]	Part no.	Type
	Power supply for motor controller	100 ... 240	24	5	8149580	CACN-3A-1-5-G2
				10	8149581	CACN-3A-1-10-G2
			48	5	8149583	CACN-3A-7-5-G2
				10	8149584	CACN-3A-7-10-G2
				20	8149585	CACN-11A-7-20-G2

 **Note**

If a common power supply unit is used to supply the power unit and the control unit, the voltage tolerances for supplying the control unit cannot be met at high braking energies. This can result in damage to the control unit. Always use separate power supplies to supply the power unit and the control unit.

Accessories

Ordering data – Documentation ¹⁾			
	Language	Part no.	Type
		Festo Handling and Positioning Profile (FHPP) for the motor controller family CMM...	
	DE	555695	P.BE-CMM-FHPP-SW-DE
	EN	555696	P.BE-CMM-FHPP-SW-EN
	ES	555697	P.BE-CMM-FHPP-SW-ES
	FR	555698	P.BE-CMM-FHPP-SW-FR
	IT	555699	P.BE-CMM-FHPP-SW-IT

1) User documentation in paper form is not included in the scope of delivery