

Series 12-REA

Sine rodless cylinder
 ø25, ø32, ø40, ø50, ø63

How to Order



Clean series
 12 — Special treatment on sliding part

Bore size (mm)

12 - REA 25 [] - 300

Cylinder stroke (mm)

Port type

Symbol	Type
Nil	Rc
TN	NPT
TF	G

Model

Model	Bore size (mm)	Port size	Lubrication	Standard stroke (mm)	Maximum manufacturable stroke (mm)
12-REA25	25	Rc1/8 NPT1/8 G1/8	Non-lube	200, 250, 300, 350, 400, 450, 500, 600, 700, 800	1300
12-REA32	32				
12-REA40	40	Rc1/4		200, 250, 300, 350, 400, 450, 500, 600, 700, 800, 900, 1000	
12-REA50	50	NPT1/4			
12-REA63	63	G1/4			

Note 1) Stroke exceeding the standard stroke will be available upon request as special product.

Note 2) Intermediate stroke is available by the 1 mm interval.

Note 3) Please contact SMC if the maximum manufacturable stroke is exceeded.

Specifications

Item	Bore size (mm)	
		25/32/40/50/63
Proof pressure		1.05MPa
Max. operating pressure		0.7MPa
Min. operating pressure		0.18MPa
Ambient and fluid temperature		-10 to 60°C (With no freezing)
Piston speed		50 to 300 mm/s
Stroke length tolerance		0 to 250 st: $^{+1.0}_0$, 251 to 1000 st: $^{+1.4}_0$, 1001 st to $^{+1.8}_0$
Grease		Fluorine grease
Particle generation grade (Refer to front matter pages 13 to 22 for details.)		Grade 3

Magnetic holding force

Bore size (mm)	25	32	40	50	63
Holding force N	363	588	922	1471	2256

Dimensions

12-REA 25 to 40

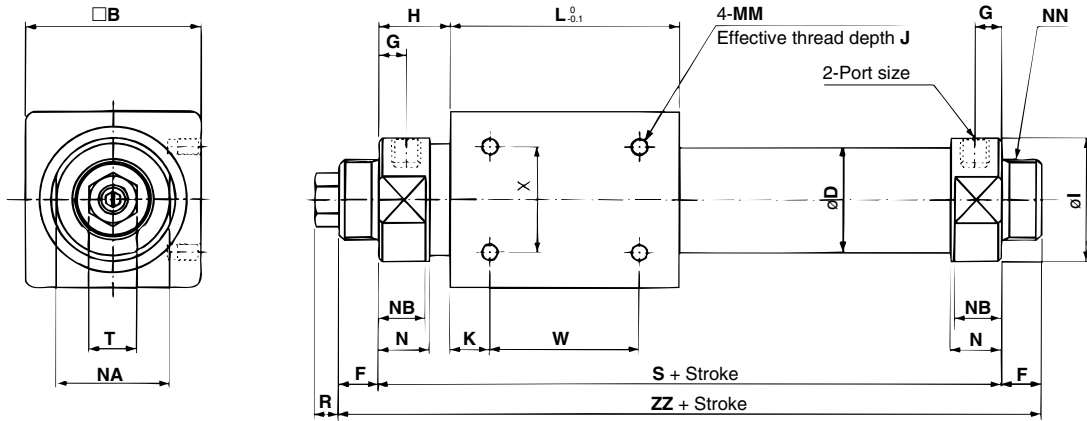

Model	Port size	B	D	F	G	H	I	K	L	MM x J	N	NA	NB	NN	S	W	X	ZZ	R	T
12-REA25	Rc, NPT, G 1/8	46	27.8	13	8	20.5	34	10	70	M5 x 0.8 x 8	15	30	13	M26 x 1.5	111	50	30	137	8	17
12-REA32	Rc, NPT, G 1/8	60	35	16	9	22	40	15	80	M6 x 1.0 x 8	17	36	15	M26 x 1.5	124	50	40	156	8	17
12-REA40	Rc, NPT, G 1/4	70	43	16	11	29	50	16	92	M6 x 1.0 x 10	21	46	19	M32 x 2.0	150	60	40	182	10	19

12- REA 50/63

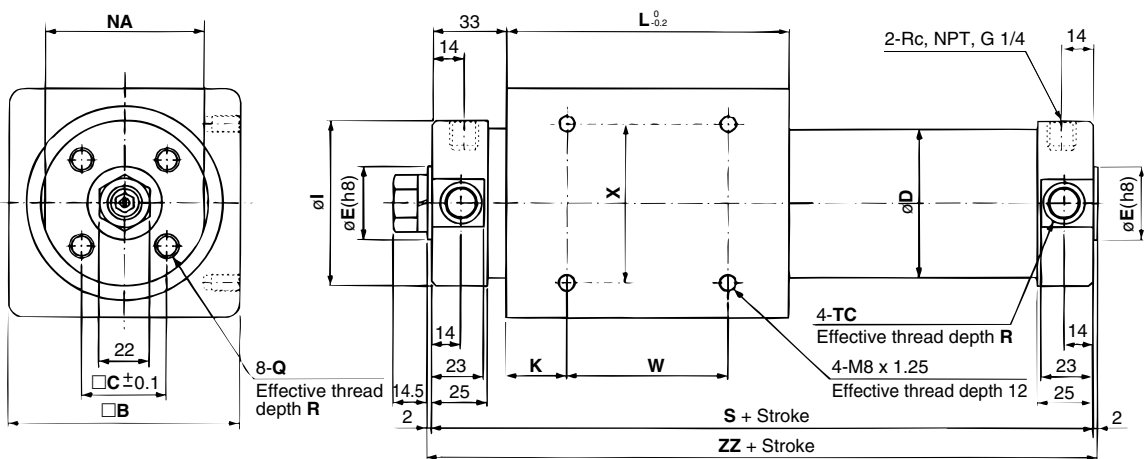

Model	B	C	D	E	I	K	L	NA	Q x R	S	TC x R	W	X	ZZ
12-REA50	86	32	53	30 ⁰ _{-0.033}	58.2	25	110	55	M8 x 1.25 x 16	176	M12 x 1.25 x 7.5	60	60	180
12-REA63	100	38	66	32 ⁰ _{-0.039}	72.2	26	122	69	M10 x 1.5 x 16	188	M14 x 1.5 x 11.5	70	70	192



Specific Product Precautions

Be sure to read before handling.

12-CY1B/3B/1R/3R/REA. Common Precautions

⚠ Caution

- 1. Use caution to the rotation of the external slider.**
Rotation should be controlled by connecting the external slider to another shaft (linear guide, etc.).
- 2. Do not operate with the magnetic coupling out of position.**
If the magnetic coupling is out of position, push the external slider by hand (or the position slider with air pressure) back to the proper position at the stroke end.
- 3. Do not apply a lateral load to the external slider.**
When a load is mounted directly to the cylinder, variations in the alignment of each shaft center cannot be offset, which results in the generation of a lateral load that can cause malfunction. The cylinder should be operated using a connection method which allows for shaft alignment variations and deflection due to the cylinder's own weight. A drawing of a recommended mounting method is shown in Figure 1.

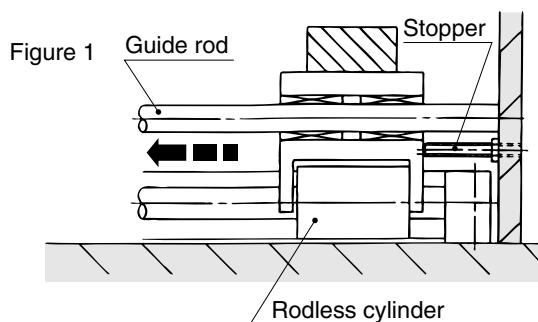

- 4. When used for vertical operation, use caution regarding allowable load.**
When used for vertical operation, use caution as there is a possibility of dropping due to separation of the magnetic coupling if a load greater than the allowable value is added. When used for vertical operation, contact SMC for the operating conditions (pressure, load, speed, stroke, frequency, etc.). Refer to Best Pneumatics vol.8 (CY1 series model selection method) for details.
- 5. Do not scratch or gouge the external surface of the cylinder.**
It can damage the wear ring, increase particle generation and cause malfunction.
- 6. Do not use the cylinder with its body fixed.**
Be sure to secure both head covers (or end covers in case of CY1R) before using the cylinder. Operation of the cylinder with its body fixed will damage the wear ring, resulting in increase of particle generation or malfunction.

12- CY1R/3R

⚠ Caution

- 1. Pay attention to the cylinder mounting surface.**
If there is any clearance between the end covers on both ends and the mounting surfaces, adjust the shim with a spacer for secure installation.

12- REA

⚠ Caution

- 1. Stroke adjustment is provided for position adjustment.**
This mechanism is not intended for adjustment of the cushion effect (smooth start-up, soft stop). This mechanism is for matching of the cylinder's stroke end position to the mechanical stopper, etc., of a machine.
- 2. Stroke adjustment should be conducted with no pressure supply.**
To ensure safety, stroke adjustment should be conducted with no pressure supply. Before adjustment is performed, shut off the drive air, release any residual pressure and implement measures to prevent dropping of workpieces, etc. Adjustment procedure is shown below.
 - 1) Insert a wrench into the hexagon hole of the adjustment screw to loosen lock nut A.
 - 2) Rotate the adjustment screw to right and left and move the cushion ring holder (stroke end) forward and backward to align the position with that of the external stopper.
 - 3) After the stroke end adjustment is completed, retighten lock nut A.

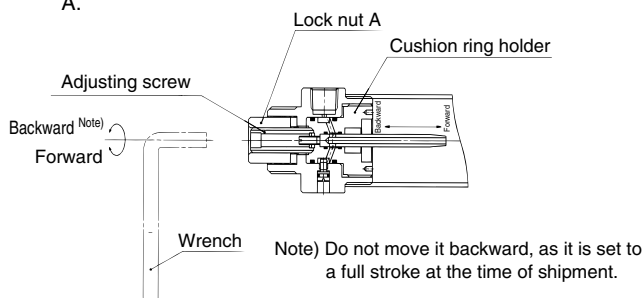

•Adjusting screw width across flats •Lock nut A tightening torque

Model	Width across flats (mm)	Model	Tightening torque (N·m)
12-REA25	5	12-REA25	1.2
12-REA32	5	12-REA32	1.2
12-REA40	6	12-REA40	2.1
12-REA50	8	12-REA50	3.4
12-REA63	8	12-REA63	3.4

3. Throttle type speed controllers are recommended for speed adjustment, as shown in the table below.

•Recommended speed controller

Model	Model		
	Elbow type	Straight type	In-line type
12-REA25	10-AS2201F-01-06-X214	10-AS2301F-01-06-X214	10-AS2001F-06-X214
12-REA32	10-AS2201F-02-06-X214	10-AS2301F-02-06-X214	10-AS2001F-06-X214
12-REA40	10-AS2201F-02-06-X214	10-AS2301F-02-06-X214	10-AS2001F-06-X214
12-REA50	10-AS3201F-02-08-X214	10-AS3301F-02-08-X214	10-AS3001F-08-X214
12-REA63	10-AS3201F-02-08-X214	10-AS3301F-02-08-X214	10-AS3001F-08-X214

Although speed adjustment is possible with meter-in and meter-out speed controllers, smooth start-up and soft stop may not be achieved.

In case the mounting orientation is not horizontal, a system with a pressure regulating circuit on the lower side is recommended. (It is also effective to shorten start-up delay in rising and for energy conservation.)

4. Cushion adjustment is not necessary.

The fixed cushion mechanism does not require the conventional cushion adjustment.

12-CY1B/3B

12- CY1R/3R

⚠ Warning

1. Use caution as the attractive power of the magnets is very strong.

When removing the external slider and piston slider from the cylinder tube for maintenance, etc., handle with caution, since the magnets installed in each slider have a very strong attractive force.

⚠ Caution

1. Use caution when taking off the external slider, as the piston slider will be directly attracted to it.

When removing the external slider or piston slider from the cylinder tube, first force the sliders out of their magnetically coupled positions, and then remove them individually when there is no longer any holding force. If they are removed while still magnetically coupled, they will be directly attracted to one another and will not come apart.

2. Use caution to the direction of the external slider and the piston slider.

Since the external slider and piston slider are directional for $\phi 6$, $\phi 10$ and holding type L, refer to the figures below when performing disassembly or maintenance. Put the external slider and piston slider together, and insert the piston slider into the cylinder tube so that they will have the correct positional relationship as shown in Fig. (2). If they align as shown in Fig. (3), insert the piston slider after turning it around 180° .

If the direction is not correct, it will be impossible to obtain the specified holding force.

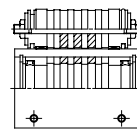

Figure 2. Correct positioning

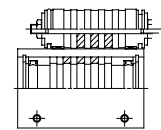

Figure 3. Positioning in incorrect direction

Example : $\phi 20$ to $\phi 63$ with L type holding force

3. Do not disassemble the magnetic components (piston slider and external slider).

This can cause a loss of holding force and malfunction.

4. Since it is possible to change the magnetic holding force (from H type to L type), please contact SMC if this is necessary.

5. When disassembling to replace the seals and wear ring, refer to the separate disassembly instructions.

⚠ Caution

6. Apply additional tightening when remounting the head cover after disassembly.

When disassembling, hold the wrench flat section of one head cover with a vice, and remove the other cover using a spanner or adjustable angle wrench on its wrench flat section. When retightening, first coat with Loctite (No. 542 red) and retighten 3° to 5° past the original position prior to removal.

6. Special tools are necessary for disassembly.

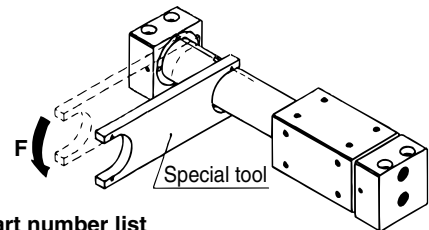

Special tool part number list

Part no.	Applicable bore size (mm)
CYRZ-V	6, 10, 15, 20
CYRZ-W	25, 32, 40
CYRZ-X	50
CYRZ-Y	63

12- REA

⚠ Warning

1. Do not disassemble the product because it may damage the air cushion mechanism.

Contact SMC when disassembly or maintenance is necessary .

Air cylinder

Rotary actuator

Air gripper

Directional control valve

Flow control equipment

Filter, Pressure control equipment

Fittings & Tubing

Air preparation equipment

Pressure switch

Clean gas filter