

Cylinder with Turntable

MGT Series

ø63, ø80, ø100

How to Order

MGT M 63 - 50 - 11 M9BW - M9BW 4

Cylinder with Turntable

Guide rod bearing type

M	Slide bearing
L	Ball bushing bearing

Bore size

63	63 mm
80	80 mm
100	100 mm

Port thread type

Nil	Rc
TN	NPT
TF	G

Stroke (mm)
Refer to "Standard Stroke" on page 638.

Cylinder unit/ Auto switch

Nil	Without auto switch (Built-in magnet)
-----	---------------------------------------

* For the applicable auto switch model, refer to the table below.

Cylinder unit/ Number of auto switches

Nil	2 pcs.
S	1 pc.

Table unit/ Number of auto switches

S	1 pc.
2	2 pcs.
3	3 pcs.
4	4 pcs.

Table position detector hardware

Symbol	Positioning angle	Switch bracket	Position detector arms			
			a	b	c	d
10	90°	×	×	×	×	×
11		○	○	○	○	○
12		○	○	○	○	×
13		○	○	×	○	○
14		○	○	×	×	×
15	180°	○	○	×	×	×
20		×	×	×	×	×
23		○	○	×	×	×
25		○	○	×	×	×

Table unit/ Auto switch

Nil	Without auto switch (Built-in magnet)
-----	---------------------------------------

* For the applicable auto switch model, refer to the table below.

Cylinder Unit/Applicable Auto Switches

Refer to pages 1119 to 1245 for detailed specifications of auto switches.

Type	Special function	Electrical entry	Indicator light	Wiring (Output)	Load voltage		Auto switch model		Lead wire length (m)					Pre-wired connector	Applicable load
					DC	AC	Perpendicular	In-line	0.5 (Nil)	1 (M)	3 (L)	5 (Z)			
Solid state auto switch	—	Grommet	Yes	3-wire (NPN)	5 V, 12 V	—	M9NV	M9N	●	●	●	○	○	IC circuit	Relay, PLC
				3-wire (PNP)			M9PV	M9P	●	●	●	○	○		
				2-wire	M9BV	M9B	●	●	●	○	○	—			
				3-wire (NPN)	5 V, 12 V	24 V	—	M9NVW	M9NW	●	●	●	○	○	
	3-wire (PNP)	M9PVW	M9PW	●				●	●	○	○				
	Water resistant (2-color indicator)	Grommet	No	3-wire (NPN)	5 V, 12 V	—	M9NAV ⁺	M9NA ⁺	○	○	○	○	○	IC circuit	
				3-wire (PNP)			M9PAV ⁺	M9PA ⁺	○	○	●	○	○		
				2-wire	12 V	M9BAV ⁺	M9BA ⁺	○	○	●	○	○	—		
2-wire				—		—	—	—	—	—	—	—			
Reed auto switch	—	Grommet	Yes	3-wire (NPN equiv.)	5 V	—	A96V	A96	●	—	—	—	—	IC circuit	—
				2-wire	24 V	12 V	A93V ⁺ 2	A93	●	●	●	●	—	—	Relay, PLC
—	—	—	No	2-wire	24 V	12 V	A90V	A90	●	—	—	—	—	IC circuit	

- *1 Water resistant type auto switches can be mounted on the above models, but in such case SMC cannot guarantee water resistance. Consult with SMC regarding water resistant types with the above model numbers.
- *2 1 m type lead wire is only applicable to D-A93.

- * Lead wire length symbols:
0.5 m Nil (Example) M9NV
1 m M (Example) M9NVW
3 m L (Example) M9NWL
5 m Z (Example) M9NWZ
- * Solid state auto switches marked "○" are produced upon receipt of order.
- * Refer to page 643 for applicable auto switches other than listed left.
- * Refer to pages 1192 and 1193 for details of auto switches with a pre-wired connector.
- * Auto switches are shipped together (not assembled).

Table Unit/Applicable Auto Switches

Refer to pages 1119 to 1245 for detailed specifications of auto switches.

Type	Special function	Electrical entry	Indicator light	Wiring (Output)	Load voltage		Auto switch model		Lead wire length (m)					Pre-wired connector	Applicable load
					DC	AC	In-line	0.5 (Nil)	1 (M)	3 (L)	5 (Z)				
Solid state auto switch	—	Grommet	Yes	3-wire (NPN)	12 V	24 V	—	M9N	●	●	●	○	○	IC circuit	Relay, PLC
				3-wire (PNP)				M9P	●	●	●	○	○		
				2-wire	M9B	●	●	●	○	○	—				
				3-wire (NPN)	5 V, 12 V	—	M9NV	M9N	●	●	●	○	○	IC circuit	
	3-wire (PNP)	M9PV	M9P	●			●	●	○	○					
	Water resistant (2-color indicator)	Grommet	No	2-wire	12 V	—	M9BW	M9B	●	●	●	○	○	—	
				3-wire (NPN)			5 V, 12 V	24 V	—	M9NAV ⁺	M9NA ⁺	○	○		
				3-wire (PNP)	M9PAV ⁺	M9PA ⁺				○	○	●	○	○	
2-wire				12 V	M9BAV ⁺	M9BA ⁺	○	○	●	○	○	—			
2-wire	—	—	—		—	—	—	—	—						
Reed auto switch	—	Grommet	Yes	3-wire (NPN equiv.)	5 V	—	A96	A96	●	—	—	—	—	IC circuit	—
				2-wire	24 V	12 V	A93	A93	●	●	●	●	—	—	Relay, PLC
—	—	—	No	2-wire	24 V	12 V	A90	A90	●	—	—	—	—	IC circuit	

- * Lead wire length symbols:
0.5 m Nil (Example) M9NV
1 m M (Example) M9NVW
3 m L (Example) M9NWL
5 m Z (Example) M9NWZ
- * Solid state auto switches marked "○" are produced upon receipt of order.
- * The in-line electrical entry type cannot be mounted.
- * Refer to pages 1192 and 1193 for details of auto switches with a pre-wired connector.
- * Auto switches are shipped together (not assembled).

MGJ

JMP

MGP

MGPW

MGQ

MGG

MGC

MGF

MGZ

MGT

D-□

-X□

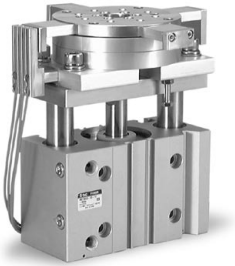

Specifications

Bore size (mm)	63	80	100
Action	Double acting		
Fluid	Air		
Proof pressure	1.5 MPa		
Maximum operating pressure	1.0 MPa		
Minimum operating pressure	0.1 MPa		
Ambient & fluid temperatures	-10 to 60°C (No freezing)		
Piston speed	50 to 400 mm/s		
Cushion	Rubber bumper on both ends		
Lubrication	Non-lube		
Stroke length tolerance	+1.5 0		
Table rotation system	Manual type		
Table rotation direction	Right, left, free repetitive rotation		
Table angle of rotation	Quarter circle 90°, half circle 180°, with positioning mechanism		

Standard Stroke

Bore size (mm)	Standard strokes (mm)
63	25, 50, 75, 100, 125,
80	
100	150, 175, 200

Intermediate strokes

Intermediate strokes (in 5 mm increments) other than the standard strokes are made by installing spacers of 5, 10, 15 and 20 mm widths.

(Ex.) 1.MGTM63-35ST is made by installing a 15 mm spacer inside a MGTM63-50ST, however the overall length will be the same as the 50ST.

Theoretical Output

Bore size (mm)	Rod size (mm)	Actuation direction	Piston area (mm ²)	Operating pressure (MPa)									
				0.2	0.3	0.4	0.5	0.6	0.7	0.8	0.9	1.0	
63	20	OUT	3117	623	935	1247	1559	1870	2182	2494	2805	3117	
		IN	2803	561	841	1121	1402	1682	1962	2242	2523	2803	
80	25	OUT	5027	1005	1508	2011	2514	3016	3519	4022	4524	5027	
		IN	4536	907	1361	1814	2268	2722	3175	3629	4082	4536	
100	30	OUT	7854	1571	2356	3142	3927	4712	5498	6283	7069	7854	
		IN	7147	1429	2144	2859	3574	4288	5003	5718	6432	7147	

Note) Theoretical output (N) = Pressure (MPa) x Piston area (mm²)

Additional Bracket Weight

Bore size (mm)	Symbols for table unit position detector bracket (kg)					
	10	11	12	13	14	15
	20	—	—	23	—	25
63	0	0.21	0.16	0.12	0.12	0.08
80	0	0.24	0.19	0.14	0.13	0.08
100	0	0.25	0.19	0.14	0.14	0.09

Weight

MGTM63 to 100 (Slide bearing)

Bore size (mm)	Model	Standard stroke (mm)							
		25	50	75	100	125	150	175	200
		63	MGTM63	6.96 (4.78)	7.81 (5.12)	8.57 (5.38)	9.32 (5.63)	10.08 (5.88)	10.83 (6.14)
80	MGTM80	12.07 (9.29)	13.31 (9.96)	14.25 (10.33)	15.18 (10.71)	16.12 (11.09)	17.06 (11.46)	18.00 (11.83)	19.87 (12.58)
100	MGTM100	17.83 (13.51)	19.56 (14.45)	20.89 (14.99)	22.22 (15.53)	23.55 (16.07)	24.88 (16.60)	26.21 (17.14)	28.87 (18.22)

MGTL63 to 100 (Ball bushing bearing)

Bore size (mm)	Model	Standard stroke (mm)							
		25	50	75	100	125	150	175	200
		63	MGTL63	6.62 (4.33)	7.49 (4.61)	8.15 (4.80)	8.91 (5.08)	9.57 (5.27)	10.24 (5.45)
80	MGTL80	12.03 (8.92)	13.33 (9.44)	14.15 (9.73)	14.97 (10.02)	15.79 (10.31)	16.61 (10.60)	17.43 (10.89)	19.07 (11.46)
100	MGTL100	17.53 (12.84)	19.33 (13.62)	20.51 (14.04)	21.69 (14.46)	22.87 (14.87)	24.04 (15.29)	25.22 (15.70)	27.58 (16.54)

Numbers inside () indicate the weight of moving parts.

Operating Conditions

Allowable eccentric load mass

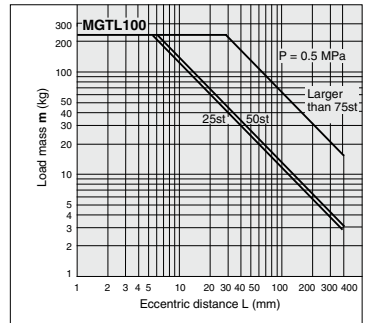
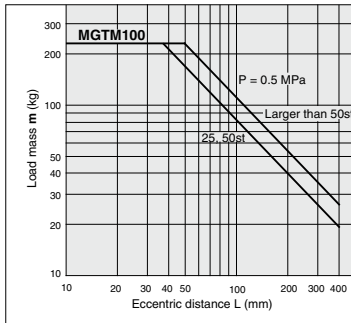
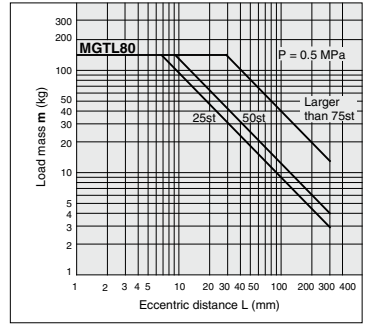
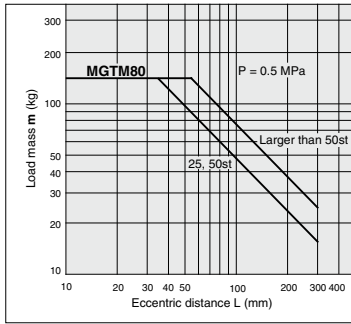
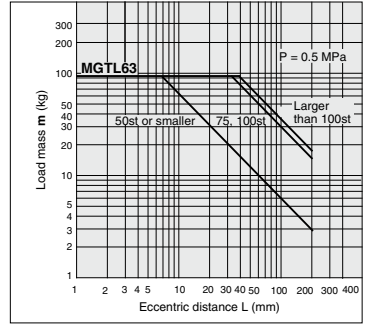
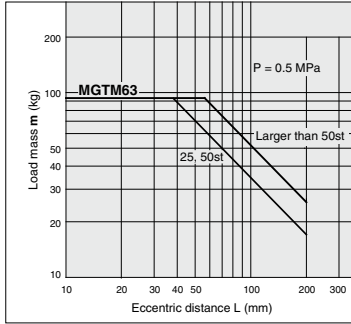
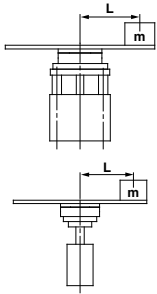

- MGJ
- JMGP
- MGP
- MGPDW
- MGQ
- MGG
- MGC
- MGF
- MGZ
- MGT

Allowable side load

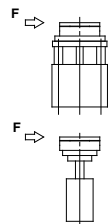

Bore size (mm)	Model	Stroke (mm)							
		25	50	75	100	125	150	175	200
63	MGTM	204	178	212	193	176	162	151	140
	MGTL	143	127	186	170	243	226	212	199
80	MGTM	250	221	291	267	246	228	213	199
	MGTL	62	154	255	237	220	205	192	180
100	MGTM	356	321	382	353	328	307	288	271
	MGTL	114	153	335	313	292	274	257	242

- D-
- X

Construction

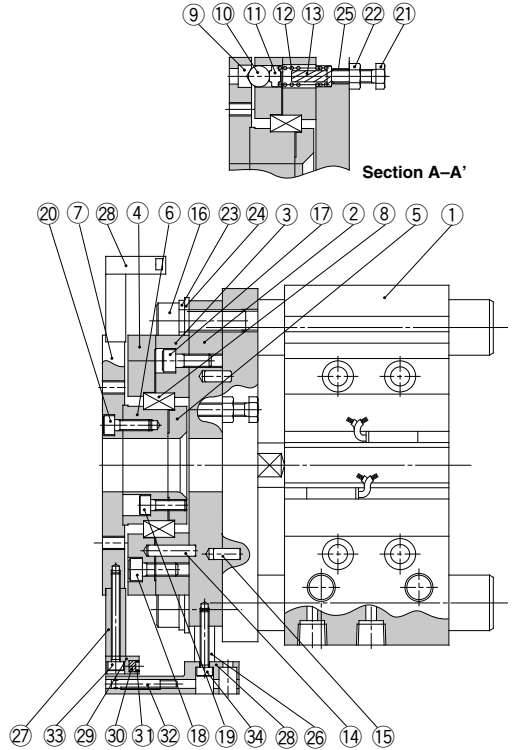
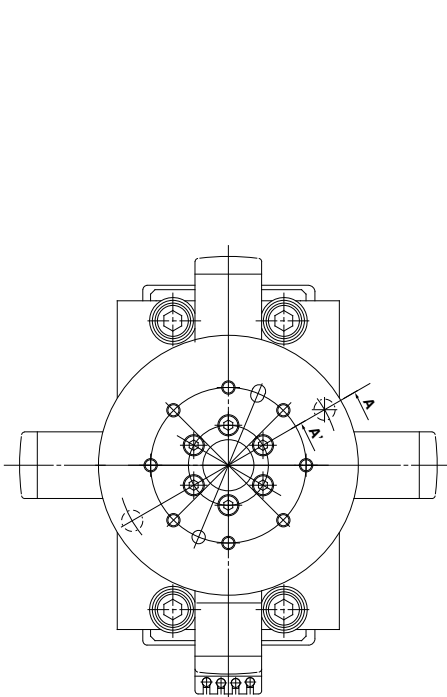

Component Parts

No.	Description	Material	Note
1	Flat cylinder w/turntable MGTM MGTL	—	MGPM63 to 100-□-□ MGPL63 to 100-□-□
2	Guide plate	Aluminum alloy	White anodized
3	Bearing guide A	Aluminum alloy	White anodized
4	Bearing guide B	Aluminum alloy	White anodized
5	Bearing guide C	Aluminum alloy	Chromated
6	Bearing guide D	Aluminum alloy	Chromated
7	Notch table	Carbon steel	Nickel plated
8	Bearing	—	
9	Notch ring	Carbon steel	Hard zinc chromated
10	Steel ball	High carbon chromium bearing steel	
11	Ball cap	Stainless steel	
12	Return spring	Piano wire	Zinc chromated

Component Parts (Position detector bracket)

No.	Description	Material	Note
26	Magnet base A	Aluminum alloy	White anodized
27	Magnet base B	Aluminum alloy	White anodized
28	Switch holder	Aluminum alloy	White anodized
29	Magnet holder	Aluminum alloy	White anodized
30	Magnet	—	
31	Retaining ring	Carbon tool steel	
32	Auto switch	—	
33	Hexagon socket head cap screw	Chrome molybdenum steel	Nickel plated
34	Hexagon socket head cap screw	Chrome molybdenum steel	Nickel plated

Note) Please refer to pages 447 and 448 for details on components and replaceable parts for flat cylinders with guides (MGPM, MGPL).

Component Parts

No.	Description	Material	Note
13	Spring guide	Carbon steel	
14	Parallel pin	High carbon chromium bearing steel	
15	Parallel pin	High carbon chromium bearing steel	
16	Hexagon socket head cap screw	Chrome molybdenum steel	Nickel plated
17	Hexagon socket head cap screw	Chrome molybdenum steel	Nickel plated
18	Hexagon socket head cap screw	Chrome molybdenum steel	Nickel plated
19	Hexagon socket head cap screw	Chrome molybdenum steel	Nickel plated
20	Hexagon socket head cap screw	Chrome molybdenum steel	Nickel plated
21	Hexagon bolt	Chrome molybdenum steel	Nickel plated
22	Hexagon nut	Carbon steel	Nickel plated
23	Spring washer	Steel wire	Nickel plated
24	Plain washer	Carbon wire	Nickel plated
25	Helical insert	Stainless steel	

Dimensions

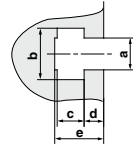
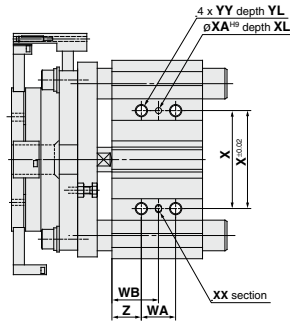
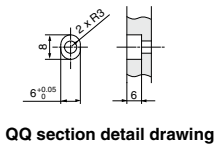
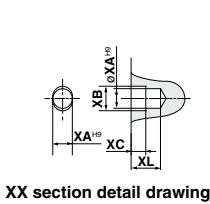

T groove dimensions (mm)

Bore size (mm)	a	b	c	d	e
63	11	17.8	10	7	18.5
80	13.3	20.3	12	8	22.5
100	15.3	23.3	13.5	10	30

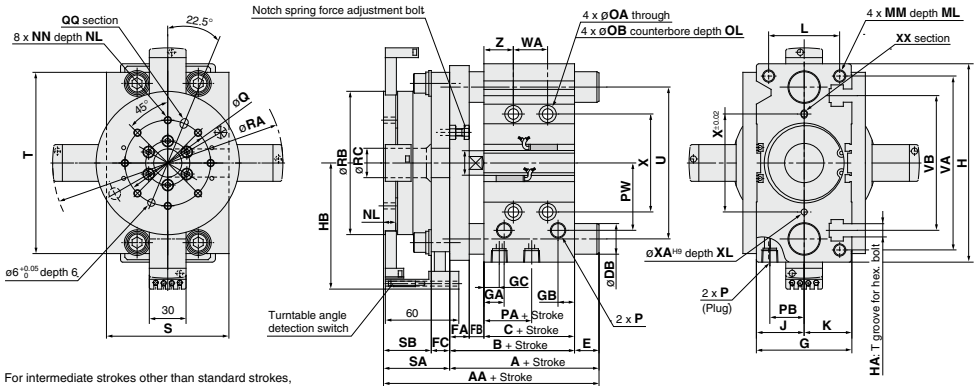

For intermediate strokes other than standard strokes, refer to the Manufacture of Intermediate Stroke on page 638.

Bore size (mm)	Standard stroke (mm)	B	C	DA	FA	FB	FC	G	GA	GB	GC	H	HA	HB	J	K	L	MM	ML	NN	NL	OA
63	25, 50, 75	77	49	20	16	12	15	78	16.5	13.5	16.5	162	M10	103	39	39	58	M10 x 1.5	22	M6 x 1.0	10	8.6
80	100, 125, 150, 175, 200	96.5	56.5	25	22	18	15	91.5	19	15.5	14.5	202	M12	121.5	45.5	46	54	M12 x 1.75	26	M8 x 1.25	12	10.6
100		116	66	30	25	25	20	111.5	23	19	18	240	M14	145	55.5	56	62	M14 x 2.0	32	M10 x 1.5	15	12.5

Bore size (mm)	OB	OL	P			PA	PB	PW	Q	RA	RB	RC	S	SA	SB	T	U	VA	VB
			Nil	TN	TF														
63	14	9	Rc 1/4	NPT 1/4	G 1/4	14	28	58	70	188	117	24	100	54	39	148	124	142	110
80	17.5	8	Rc 3/8	NPT 3/8	G 3/8	14.5	25.5	74	80	225	128	24	125	56	41	198	156	180	140
100	20	8	Rc 3/8	NPT 3/8	G 3/8	17.5	32.5	89	100	272	168	35	150	71	51	236	188	210	166

Bore size (mm)	WA			WB			X	XA	XB	XC	XL	YY	YL	Z
	25st	50, 75, 100st	Larger than 100st	25st	50, 75, 100st	Larger than 100st								
63	28	52	128	38	50	88	80	5	6	4	8	M10 x 1.5	20	24
80	28	52	128	42	54	92	100	6	7	5	10	M12 x 1.75	24	28
100	48	72	148	35	47	85	124	6	7	5	10	M14 x 2.0	28	11

Bore size (mm)	MGTM (Slide bearing)		MGTL (Ball bushing bearing)	
	AA	A	AA	A
63	160.5	172	106.5	118
80	171	198	115	142
100	208	233	137	162

Bore size (mm)	MGTM (Slide bearing)		MGTL (Ball bushing bearing)	
	AA	A	AA	A
63	160.5	172	106.5	118
80	171	198	115	142
100	208	233	137	162

- MGT
- MGC
- MGQ
- MGP
- JMGP
- MGTJ

- D
- X

Auto Switch Mounting

Auto Switch Proper Mounting Position (Detection at Stroke End)

Proper auto switch mounting position for cylinder (stroke end)

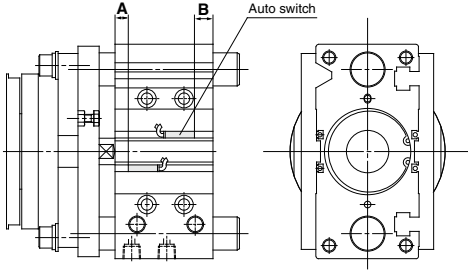

Proper Mounting Position (mm)

Auto switch model	D-M9□		D-A9□		D-Z7□/Z80	
	A	B	A	B	A	B
D-M9□V	15	19	11	15	10	14
D-M9□WV	18	23.5	14	19.5	13	18.5
D-M9□AV	22.5	28.5	18.5	24.5	17.5	23.5

Note) Adjust the auto switch after confirming the operating conditions in the actual setting.

Proper auto switch mounting position for table position detection

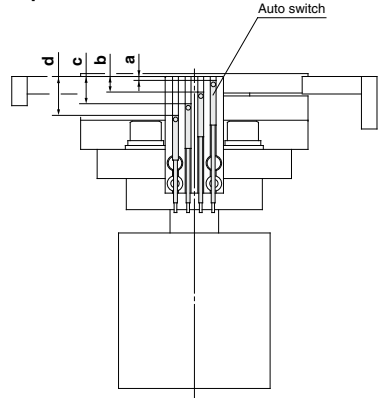

Proper Mounting Position (mm)

Auto switch model	a	b	c	d
D-A9□	2	8	14	20
D-M9□	6	12	18	24
D-M9□W/D-M9□A	5	11	17	23

* In order that adjacent auto switches do not misoperate, they should be set within ± 1 mm of the proper mounting positions indicated in the table above.

Auto Switch Mounting

When mounting an auto switch, insert it into the cylinder's auto switch groove from the direction shown in the figure below. After setting it in the mounting position, use a flat head watchmaker's screwdriver to secure it with the auto switch mounting screw which is included.

Mounting of auto switches for cylinder

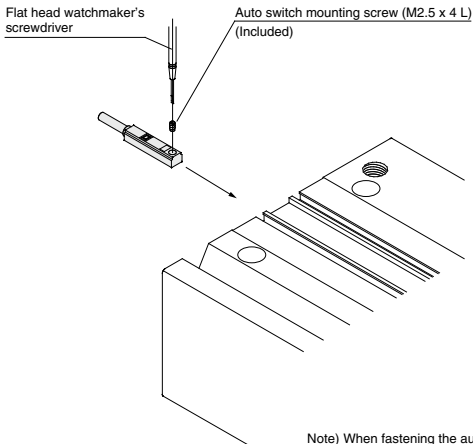

Mounting of auto switch for table position detection

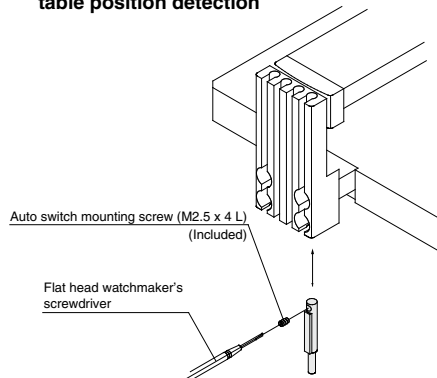

Note) When fastening the auto switch mounting screw, use a watchmaker's screwdriver with a grip diameter of 5 to 6 mm. The fastening torque should be 0.05 to 0.1 N·m. As a rule, it should be turned about 90° past the position at which tightening can be felt.

Minimum Stroke for Mounting

Auto switch model	No. of auto switches	(mm)		
		ø63	ø80	ø100
D-A9□	1 pc.		5	
	2 pcs.		10	
D-A9□V	1 pc.		5	
	2 pcs.		10	
D-M9□	1 pc.		5	
	2 pcs.		10	
D-M9□W	1 pc.		5 Note 1)	
	2 pcs.		10	
D-M9□WV	1 pc.		5 Note 2)	
	2 pcs.		10	
D-M9□A	1 pc.		5 Note 2)	
	2 pcs.		10 Note 2)	
D-Z7□	1 pc.		5	
D-Z80	2 pcs.		10	
D-Y59□	1 pc.		5	
D-Y7P	2 pcs.		10	
D-Y69□	1 pc.		5	
D-Y7PV	2 pcs.		5	
D-Y7□W	1 pc.		5 Note 2)	
D-Y7□WV	2 pcs.		10 Note 2)	
D-Y7BA	1 pc.		5 Note 2)	
	2 pcs.		10 Note 2)	

Note 1) Confirm that it is possible to secure the minimum bending radius of 10 mm of the auto switch lead wire before use.

Note 2) Confirm that it is possible to securely set the auto switch(es) within the range of indicator green light ON range before use.

For in-line entry type, please also consider Note 1) shown above.

Operating Range

Auto switch model	Bore size (mm)		
	63	80	100
D-A9□/A9□V	11	10.5	10.5
D-M9□/M9□V	7.5	7.5	8.5
D-M9□W/M9□WV			
D-M9□A/M9□AV			
D-Z7□/Z80	11.5	11.5	12
D-Y59□/Y69□	8	9.5	10
D-Y7P/Y7PV			
D-Y7□W/Y7□WV			
D-Y7BA			

* Hysteresis specifications are given as a guide, it is not a guaranteed range. (Tolerance ±30%)
Hysteresis may fluctuate due to the operating environment.

Auto Switch Mounting Bracket/Part No.

Auto switch model	Bore size (mm)
	ø63 to ø100
D-A9□/A9□V D-M9□/M9□W D-M9□W/M9□WV D-M9□A/M9□AV	BMG2-012

D-A9□(V), M9□(V), M9□W(V), M9□A(V)

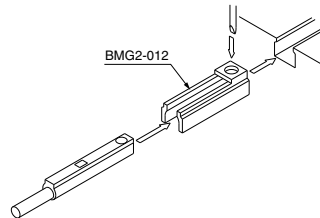

Besides the models listed in How to Order, the following auto switches can be mounted on cylinder units. Refer to pages 1119 to 1245 for the detailed specifications.

Auto switch type	Model	Electrical entry (Fetching direction)	Features
Reed	D-Z73, Z76	Grommet (In-line)	—
	D-Z80		Without indicator light
Solid state	D-Y69A, Y69B, Y7PV	Grommet (Perpendicular)	—
	D-Y7NWV, Y7PWV, Y7BWW		Diagnostic indication (2-color indicator)
	D-Y59A, Y59B, Y7P	Grommet (In-line)	—
	D-Y7NW, Y7PW, Y7BW		Diagnostic indication (2-color indicator)
	D-Y7BA		Water resistant (2-color indicator)

* For solid state auto switches, auto switches with a pre-wired connector are also available. Refer to pages 1192 and 1193 for details.

* Normally closed (NC = b contact) solid state auto switches (D-M9□E(V)/Y7G/Y7H) are also available. Refer to pages 1592-1 and 1139 for details.

MGJ

JMP

MGP

MGPW

MGQ

MGG

MGC

MGF

MGZ

MGT

D-□

-X□