

Insert Fittings

KF Series

RoHS

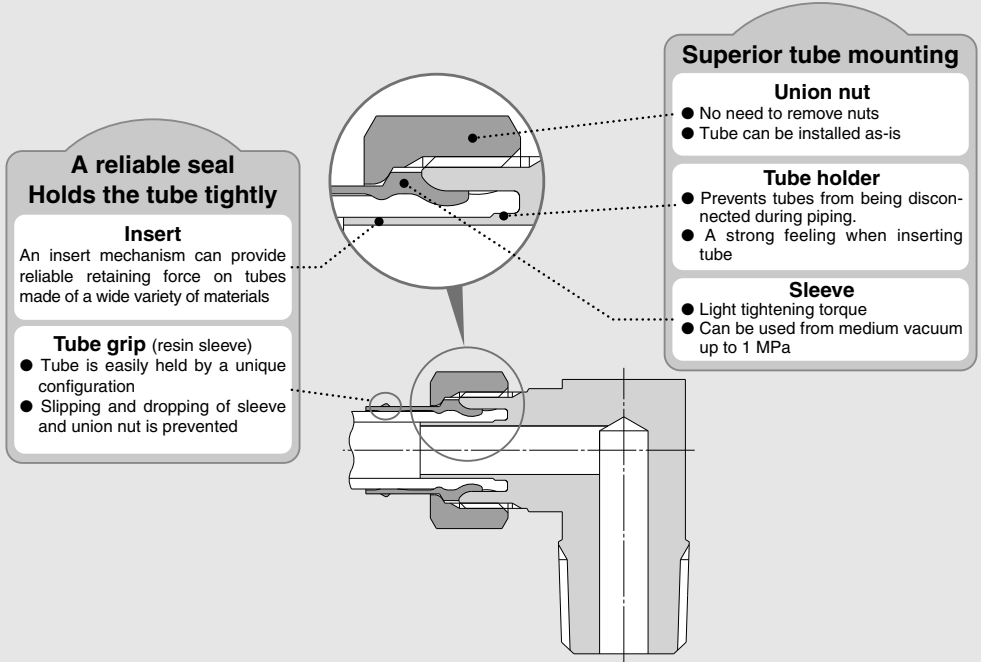

- Material / Body, Union nut: Brass
Sleeve: Resin or Brass
- Maximum operating temperature / **150°C** (Brass sleeve)
60°C (Resin sleeve)
- Applicable tubing material / FEP • PFA • Modified PTFE • Nylon
Soft nylon • Polyurethane
Polyolefin • Soft polyolefin
- Can be used with steam. (For brass sleeve)
- Grease-free

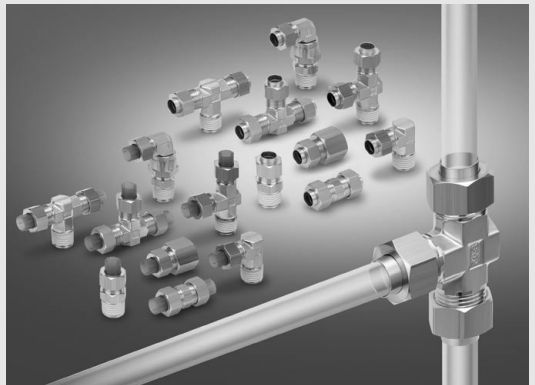

KQ2
KQB2
KS KX
KM
KF
M
H/DL L/LL
KC
KK
KK130
DM
KDM
KB
KR
KA
KQG2
KG
KFG2
MS
KKA
KP
LQ
MQR
T
IDK

Male Connector

Use to connect tubes in the same direction from female thread. Most general type.

Applicable tubing size (mm)		Connection thread	Model	
O.D.	I.D.		Resin sleeve	Brass sleeve
ø4	ø2.5	R1/8	KFH04-01S	KFH04B-01S
		R1/4	KFH04-02S	KFH04B-02S
		R1/8	KFH06-01S	KFH06B-01S
ø6	ø4	R1/4	KFH06-02S	KFH06B-02S
		R3/8	KFH06-03S	KFH06B-03S
		R1/8	KFH08U-01S	—
ø8	ø5	R1/4	KFH08U-02S	—
		R3/8	KFH08U-03S	—
		R1/8	KFH08N-01S	KFH08B-01S
ø6	ø6	R1/4	KFH08N-02S	KFH08B-02S
		R3/8	KFH08N-03S	KFH08B-03S
		R1/4	KFH10U-02S	—
ø6.5	ø3.8	R3/8	KFH10U-03S	—
		R1/2	KFH10U-04S	—
		R1/4	KFH10N-02S	KFH10B-02S
ø10	ø7.5	R3/8	KFH10N-03S	KFH10B-03S
		R1/2	KFH10N-04S	KFH10B-04S
		R1/4	KFH12U-02S	—
ø8	ø8	R3/8	KFH12U-03S	—
		R1/2	KFH12U-04S	—
		R1/4	KFH12N-02S	KFH12B-02S
ø12	ø9	R3/8	KFH12N-03S	KFH12B-03S
		R1/2	KFH12N-04S	KFH12B-04S



Branch Tee

Use to branch line from female thread in both 90° directions.

Applicable tubing size (mm)		Connection thread	Model	
O.D.	I.D.		Resin sleeve	Brass sleeve
ø4	ø2.5	R1/8	KFT04-01S	KFT04B-01S
		R1/4	KFT04-02S	KFT04B-02S
		R1/8	KFT06-01S	KFT06B-01S
ø6	ø4	R1/4	KFT06-02S	KFT06B-02S
		R3/8	KFT06-03S	KFT06B-03S
		R1/8	KFT08U-01S	—
ø8	ø5	R1/4	KFT08U-02S	—
		R3/8	KFT08U-03S	—
		R1/8	KFT08N-01S	KFT08B-01S
ø6	ø6	R1/4	KFT08N-02S	KFT08B-02S
		R3/8	KFT08N-03S	KFT08B-03S
		R1/4	KFT10U-02S	—
ø6.5	ø3.8	R3/8	KFT10U-03S	—
		R1/2	KFT10U-04S	—
		R1/4	KFT10N-02S	KFT10B-02S
ø10	ø7.5	R3/8	KFT10N-03S	KFT10B-03S
		R1/2	KFT10N-04S	KFT10B-04S
		R1/4	KFT12U-02S	—
ø8	ø8	R3/8	KFT12U-03S	—
		R1/2	KFT12U-04S	—
		R1/4	KFT12N-02S	KFT12B-02S
ø12	ø9	R3/8	KFT12N-03S	KFT12B-03S
		R1/2	KFT12N-04S	KFT12B-04S

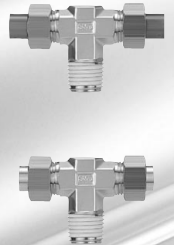

Male Elbow

Use to pipe at right angles to female thread. Most general type.

Applicable tubing size (mm)		Connection thread	Model	
O.D.	I.D.		Resin sleeve	Brass sleeve
ø4	ø2.5	R1/8	KFL04-01S	KFL04B-01S
		R1/4	KFL04-02S	KFL04B-02S
		R1/8	KFL06-01S	KFL06B-01S
ø6	ø4	R1/4	KFL06-02S	KFL06B-02S
		R3/8	KFL06-03S	KFL06B-03S
		R1/8	KFL08U-01S	—
ø8	ø5	R1/4	KFL08U-02S	—
		R3/8	KFL08U-03S	—
		R1/8	KFL08N-01S	KFL08B-01S
ø6	ø6	R1/4	KFL08N-02S	KFL08B-02S
		R3/8	KFL08N-03S	KFL08B-03S
		R1/4	KFL10U-02S	—
ø6.5	ø3.8	R3/8	KFL10U-03S	—
		R1/2	KFL10U-04S	—
		R1/4	KFL10N-02S	KFL10B-02S
ø10	ø7.5	R3/8	KFL10N-03S	KFL10B-03S
		R1/2	KFL10N-04S	KFL10B-04S
		R1/4	KFL12U-02S	—
ø8	ø8	R3/8	KFL12U-03S	—
		R1/2	KFL12U-04S	—
		R1/4	KFL12N-02S	KFL12B-02S
ø12	ø9	R3/8	KFL12N-03S	KFL12B-03S
		R1/2	KFL12N-04S	KFL12B-04S



Male Run Tee

Use to branch line in the same direction from female thread and in 90° direction.

Applicable tubing size (mm)		Connection thread	Model	
O.D.	I.D.		Resin sleeve	Brass sleeve
ø4	ø2.5	R1/8	KFY04-01S	KFY04B-01S
		R1/4	KFY04-02S	KFY04B-02S
		R1/8	KFY06-01S	KFY06B-01S
ø6	ø4	R1/4	KFY06-02S	KFY06B-02S
		R3/8	KFY06-03S	KFY06B-03S
		R1/8	KFY08U-01S	—
ø8	ø5	R1/4	KFY08U-02S	—
		R3/8	KFY08U-03S	—
		R1/8	KFY08N-01S	KFY08B-01S
ø6	ø6	R1/4	KFY08N-02S	KFY08B-02S
		R3/8	KFY08N-03S	KFY08B-03S
		R1/4	KFY10U-02S	—
ø6.5	ø3.8	R3/8	KFY10U-03S	—
		R1/2	KFY10U-04S	—
		R1/4	KFY10N-02S	KFY10B-02S
ø10	ø7.5	R3/8	KFY10N-03S	KFY10B-03S
		R1/2	KFY10N-04S	KFY10B-04S
		R1/4	KFY12U-02S	—
ø8	ø8	R3/8	KFY12U-03S	—
		R1/2	KFY12U-04S	—
		R1/4	KFY12N-02S	KFY12B-02S
ø12	ø9	R3/8	KFY12N-03S	KFY12B-03S
		R1/2	KFY12N-04S	KFY12B-04S



Female Union

Use to pipe from male thread such as pressure gauge.

Applicable tubing size (mm)		Connection thread	Model	
O.D.	I.D.		Resin sleeve	Brass sleeve
ø4	ø2.5	R1/4	KFF04-02	KFF04B-02
		R1/4	KFF06-02	KFF06B-02
ø6	ø4	R3/8	KFF06-03	KFF06B-03
		R1/4	KFF08U-02	—
ø8	ø6	R1/4	KFF08N-02	KFF08B-02
		R1/4	KFF10U-02	—
ø10	ø7.5	R1/4	KFF10N-02	KFF10B-02
		R1/4	KFF12U-02	—
ø12	ø9	R1/4	KFF12N-02	KFF12B-02

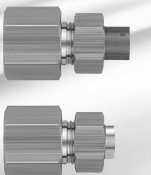

Bulkhead Connector

Use to connect male thread and tube through a panel.

Applicable tubing size (mm)		Connection thread	Model	
O.D.	I.D.		Resin sleeve	Brass sleeve
ø6	ø4	R1/4	KFE06-02	KFE06B-02
		R3/8	KFE08U-03	—
ø8	ø6	R3/8	KFE08N-03	KFE08B-03
		R3/8	KFE10U-03	—
ø10	ø7.5	R3/8	KFE10N-03	KFE10B-03
		R3/8	KFE12U-03	—
ø12	ø9	R3/8	KFE12N-03	KFE12B-03

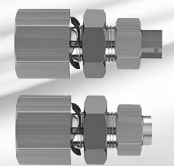

Swivel Elbow

Use to pipe at right angles to female thread. Swiveled at any direction.

Applicable tubing size (mm)		Connection thread	Model	
O.D.	I.D.		Resin sleeve	Brass sleeve
ø4	ø2.5	R1/8	KFV04-01S	KFV04B-01S
		R1/4	KFV04-02S	KFV04B-02S
ø6	ø4	R1/8	KFV06-01S	KFV06B-01S
		R1/4	KFV06-02S	KFV06B-02S
		R3/8	KFV06-03S	KFV06B-03S
ø8	ø5	R1/8	KFV08U-01S	—
		R1/4	KFV08U-02S	—
		R3/8	KFV08U-03S	—
ø6	ø6	R1/8	KFV08B-01S	KFV08B-01S
		R1/4	KFV08B-02S	KFV08B-02S
ø10	ø6.5	R3/8	KFV10U-03S	—
		R1/2	KFV10U-04S	—
ø7.5	ø7.5	R1/4	KFV10N-02S	KFV10B-02S
		R3/8	KFV10N-03S	KFV10B-03S
		R1/2	KFV10N-04S	KFV10B-04S
ø8	ø8	R1/4	KFV12U-02S	—
		R3/8	KFV12U-03S	—
		R1/2	KFV12U-04S	—
ø12	ø9	R1/4	KFV12N-02S	KFV12B-02S
		R3/8	KFV12N-03S	KFV12B-03S
		R1/2	KFV12N-04S	KFV12B-04S



Swivel Long Elbow

Use to pipe at right angles to female thread. Swiveled at any direction. Solid piece moves fittings up from workpiece.

Applicable tubing size (mm)		Connection thread	Model	
O.D.	I.D.		Resin sleeve	Brass sleeve
ø4	ø2.5	R1/8	KFW04-01S	KFW04B-01S
		R1/4	KFW04-02S	KFW04B-02S
ø6	ø4	R1/8	KFW06-01S	KFW06B-01S
		R1/4	KFW06-02S	KFW06B-02S
		R3/8	KFW06-03S	KFW06B-03S
ø8	ø5	R1/8	KFW08U-01S	—
		R1/4	KFW08U-02S	—
		R3/8	KFW08U-03S	—
ø6	ø6	R1/8	KFW08B-01S	KFW08B-01S
		R1/4	KFW08B-02S	KFW08B-02S
ø10	ø6.5	R3/8	KFW10U-03S	—
		R1/2	KFW10U-04S	—
ø7.5	ø7.5	R1/4	KFW10N-02S	KFW10B-02S
		R3/8	KFW10N-03S	KFW10B-03S
		R1/2	KFW10N-04S	KFW10B-04S
ø8	ø8	R1/4	KFW12U-02S	—
		R3/8	KFW12U-03S	—
		R1/2	KFW12U-04S	—
ø12	ø9	R1/4	KFW12N-02S	KFW12B-02S
		R3/8	KFW12N-03S	KFW12B-03S
		R1/2	KFW12N-04S	KFW12B-04S



Straight Union

Use to connect tubes in the same direction.

Applicable tubing size (mm)		Model	
O.D.	I.D.	Resin sleeve	Brass sleeve
ø4	ø2.5	KFH04-00	KFH04B-00
		KFH06-00	KFH06B-00
ø6	ø4	KFH08U-00	—
		KFH08N-00	KFH08B-00
ø8	ø6	KFH10U-00	—
		KFH10N-00	KFH10B-00
ø10	ø7.5	KFH12U-00	—
		KFH12N-00	KFH12B-00

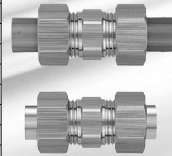

Tee Union

Use to connect tubes in both 90° directions.

Applicable tubing size (mm)		Model	
O.D.	I.D.	Resin sleeve	Brass sleeve
ø4	ø2.5	KFT04-00	KFT04B-00
		KFT06-00	KFT06B-00
ø6	ø4	KFT08U-00	—
		KFT08N-00	KFT08B-00
ø8	ø6	KFT10U-00	—
		KFT10N-00	KFT10B-00
ø10	ø7.5	KFT12U-00	—
		KFT12N-00	KFT12B-00

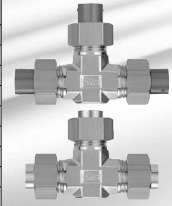

Bulkhead Union

Use to connect tubes through a panel.

Applicable tubing size (mm)		Model	
O.D.	I.D.	Resin sleeve	Brass sleeve
ø4	ø2.5	KFE04-00	KFE04B-00
		KFE06-00	KFE06B-00
ø6	ø4	KFE08U-00	—
		KFE08N-00	KFE08B-00
ø8	ø6	KFE10U-00	—
		KFE10N-00	KFE10B-00
ø10	ø7.5	KFE12U-00	—
		KFE12N-00	KFE12B-00

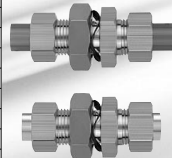

Plug

Use to plug unused fittings.

Applicable tubing size (mm)		Model
ø4		KFP-04
ø6		KFP-06
ø8		KFP-08
ø10		KFP-10
ø12		KFP-12



KQ2

KQB2

KS
KX

KM

KF

M

H/DL
L/LL

KC

KK

KK130

DM

KDM

KB

KR

KA

KQG2

KG

KFG2

MS

KKA

KP

LQ

MQR

T

IDK

Insert Fittings

KF Series



Resin sleeve



Brass sleeve

Specifications

Sleeve material	Resin	Brass
Fluid	Air, N ₂ , Water, Turbine oil class 1 (ISO VG32) ^{(Note 2) (Note 3) (Note 5)}	Air, N ₂ , Steam, Turbine oil class 1 (ISO VG32) ^{(Note 2) (Note 3)}
Ambient and fluid temperature	-5 to 60°C (No freezing) ^(Note 4) Water: 0 to 60°C (No freezing)	-5 to 150°C (No freezing) ^(Note 4)
Operating pressure range ^(Note 1)	-101.3 kPa to 1 MPa ^(Note 4)	
Proof pressure	7.0 MPa (at 60°C)	
Lubricant	Grease-free	
Seal on the threads	None or with sealant	

Note 1) Do not use the fittings with a leak tester or for vacuum retention because they are not guaranteed for zero leakage.
 Note 2) Swivel type is not compatible with water, steam and turbine oil class 1 (ISO VG32).
 Note 3) Consult with SMC regarding applicable tube separately.
 Note 4) Check the operating pressure range and operating temperature range of the tubing.
 Note 5) Deionized water is not recommended for use as it may affect the material used in the fittings. In addition, it is known to degrade the water quality.

Applicable Tubing

Series	Tubing O.D.	Tubing O.D. x I.D. (mm)								
		ø4 x ø2.5	ø6 x ø4	ø8 x ø5	ø8 x ø6	ø10 x ø6.5	ø10 x ø7.5	ø12 x ø8	ø12 x ø9	
T	Nylon	●	●	—	●	—	●	—	●	
TS	Soft nylon	●	●	—	●	—	●	—	●	
TU	Polyurethane	●	●	●	—	●	—	●	—	
TPH	Polyolefin	●	●	—	●	—	●	—	●	
TPS	Soft polyolefin	●	●	—	●	—	●	—	●	
TH	FEP	●	●	—	●	—	●	—	●	
TL	Super PFA	—	●	—	—	—	—	—	—	
TD	Modified PTFE	●	●	—	●	—	●	—	●	
TUS	Soft polyurethane	●	●	●	—	●	—	●	—	
TUH	Hard polyurethane (High pressure)	●	●	—	●	—	●	—	●	
TUZ	Wear resistant polyurethane	●	●	●	—	●	—	●	—	

How to Order

KF H 06 — **01 S** —

Type	Description
H	Male connector Straight union
L	Male elbow
T	Branch tee Tee union
F	Female union
E	Bulkhead connector Bulkhead union
Y	Male run tee
V	Swivel elbow
W	Swivel long elbow

Applicable tubing O.D.	
04	ø4
06	ø6
08	ø8
10	ø10
12	ø12

● **Made to Order**
Refer to page 179 for details.

● **Bore size / Applicable tubing O.D.**

Thread connection	01	R1/8
	02	R1/4, Rc1/4
	03	R3/8, Rc3/8
	04	R1/2, Rc1/2
Tubing connection	00	Same tubing size

Sealant (Male thread)	
Nil	None
S	With sealant

● **Applicable tubing / Sleeve material**

Applicable tubing material	Sleeve material	Tubing size (O.D. x I.D.)								
		ø4 x ø2.5	ø6 x ø4	ø8 x ø5	ø8 x ø6	ø10 x ø6.5	ø10 x ø7.5	ø12 x ø8	ø12 x ø9	
Nylon	Resin	Nil	—	N	—	N	—	N	—	
	Brass	B	—	B	—	B	—	B	—	
Soft nylon	Resin	Nil	—	N	—	N	—	N	—	
	Brass	B	—	B	—	B	—	B	—	
Polyurethane	Resin	Nil	U	—	U	—	U	—	—	
	Brass	B	—	B	—	B	—	B	—	
Polyolefin	Resin	Nil	—	N	—	N	—	N	—	
	Brass	B	—	B	—	B	—	B	—	
Soft polyolefin	Resin	Nil	U	—	U	—	U	—	—	
	Brass	B	—	B	—	B	—	B	—	
FEP	Resin	Nil	—	N	—	N	—	N	—	
	Brass	B	—	B	—	B	—	B	—	
Super PFA	Resin	—	Nil	—	N	—	—	—	—	
	Brass	—	B	—	B	—	—	—	—	
Modified PTFE	Resin	Nil	—	N	—	N	—	N	—	
	Brass	B	—	B	—	B	—	B	—	
Soft polyurethane	Resin	Nil	U	—	U	—	U	—	—	
	Hard polyurethane (High pressure)	Resin	Nil	U	—	U	—	U	—	
Wear resistant polyurethane	Resin	Nil	U	—	U	—	U	—		

For details on applicable tubing O.D. and port size combinations for each model, refer to the charts on the Dimensions page.

Construction

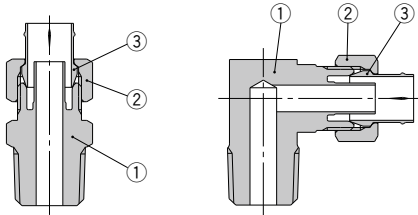

Principal Parts Material

No	Part no.	Material
1	Body	C3604, C3771
2	Union nut	C3604
3	Resin sleeve, plug	Nylon 66
	Brass sleeve	C2700

Identification of Fitting Body Exterior by Applicable Tubing

- Fittings used with polyurethane tube and soft polyolefin tube (Tube O.D. $\phi 8$, $\phi 10$ and $\phi 12$) are identified by the following marks on the body.
- Union nut and sleeve are compatible.

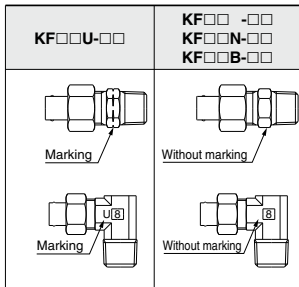

Swivel Type / Part No.

Swivel type fitting parts lineup

The bodies of elbow connectors and extended elbow connectors are compatible with almost any fitting. (Exceptions are "KFV-04" and "KFW-04" which are for the body of a $\phi 6$ tube.) Swivel fittings, elbow (KFV) and (KFW) constitute the combination with a male connector (KFH) and connector as shown in the diagram.

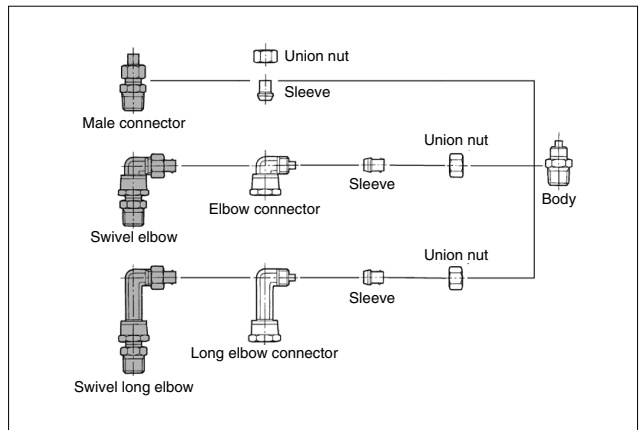

Made to Order

Symbol	Specifications
X2	Copper-free (Electroless nickel plated)

Suffix "X2" to the end of part number.
Ex.) KFH06-01S-X2

Elbow Connector: KFV

Part no.	Applicable tubing O.D./I.D.
KFV-04	$\phi 4/\phi 2.5$
KFV-06	$\phi 6/\phi 4$
KFV-08U	$\phi 8/\phi 5$
KFV-08N	$\phi 8/\phi 6$
KFV-10U	$\phi 10/\phi 6.5$
KFV-10N	$\phi 10/\phi 7.5$
KFV-12U	$\phi 12/\phi 8$
KFV-12N	$\phi 12/\phi 9$

Union Nut: KFN

Part no.	Applicable tubing O.D.
KFN-04	$\phi 4$
KFN-06	$\phi 6$
KFN-08	$\phi 8$
KFN-10	$\phi 10$
KFN-12	$\phi 12$

Long Elbow Connector: KFW

Part no.	Applicable tubing O.D./I.D.
KFW-04	$\phi 4/\phi 2.5$
KFW-06	$\phi 6/\phi 4$
KFW-08U	$\phi 8/\phi 5$
KFW-08N	$\phi 8/\phi 6$
KFW-10U	$\phi 10/\phi 6.5$
KFW-10N	$\phi 10/\phi 7.5$
KFW-12U	$\phi 12/\phi 8$
KFW-12N	$\phi 12/\phi 9$

Sleeve: KFS

Part no.		Applicable tubing O.D.
Resin sleeve	Brass sleeve	
KFS-04	KFSB-04	$\phi 4$
KFS-06	KFSB-06	$\phi 6$
KFS-08	KFSB-08	$\phi 8$
KFS-10	KFSB-10	$\phi 10$
KFS-12	KFSB-12	$\phi 12$

KF Series

Dimensions

Male Connector: KFH

Applicable tubing size (mm)		Conne- tion thread	Model	Width across flats		L ₁	L ₂	M	ød	A*	Effective area (mm ²)	Weight (g)		
O.D.	I.D.			H ₁	H ₂									
ø4	ø2.5	R1/8	KFH04-01S	10		29.6	22.9	15.5	1.5	1.6	13			
		R1/4	KFH04-02S	14		34	27.3							
		R1/8	KFH04B-01S	10	10	26.5	23.5	12.4	1.5	1.6				
		R1/4	KFH04B-02S	14		30.9	27.9							
ø6	ø4	R1/8	KFH06-01S	10		29.3	22.6	15.2	3	6	14			
		R1/4	KFH06-02S	14		33.7	27							
		R3/8	KFH06-03S	17	12	34.1	27.4	12.2	3	6				
		R1/8	KFH06B-01S	10		26.3	23.3							
		R1/4	KFH06B-02S	14		30.7	27.7	12.2	3	6				
		R3/8	KFH06B-03S	17		31.1	28.1							
ø8	ø5	R1/8	KFH08U-01S	12		29.3	22.6	16.2	4	11	16			
		R1/4	KFH08U-02S	14		33.7	27							
		R3/8	KFH08U-03S	17		34.1	27.4							
	ø6	ø5	R1/8	KFH08N-01S	12		29.3	22.6	16.2	5	17	16		
			R1/4	KFH08N-02S	14	14	33.7	27						
			R3/8	KFH08N-03S	17		34.1	27.4						
		ø6	ø5	R1/8	KFH08B-01S	12		26.4	23.4	13.3	5	17	17	
				R1/4	KFH08B-02S	14		30.8	27.8					
				R3/8	KFH08B-03S	17		31.2	28.2					
			ø10	ø6.5	R1/4	KFH10U-02S	17		35.3	28	18.8	5.5	21	32
					R3/8	KFH10U-03S	17		35.7	28.4				
					R1/2	KFH10U-04S	22		38.9	31.6				
ø7.5	ø6.5	R1/4		KFH10N-02S	17		35.3	28	18.8	6.5	30	31		
		R3/8		KFH10N-03S	17	17	35.7	28.4						
		R1/2		KFH10N-04S	22		38.9	31.6						
	ø7.5	ø6.5		R1/4	KFH10B-02S	17		31.5	28.5	15.0	6.5	30	33	
				R3/8	KFH10B-03S	17		31.9	28.9					
				R1/2	KFH10B-04S	22		35.1	32.1					
ø12	ø8	R1/4	KFH12U-02S	17		35.8	29	19.3	7	35	33			
		R3/8	KFH12U-03S	17		36.2	29.4							
		R1/2	KFH12U-04S	22		39.4	32.6							
	ø9	ø8	R1/4	KFH12N-02S	17		35.8	29	19.3	8	45	31		
			R3/8	KFH12N-03S	17	19	36.2	29.4						
			R1/2	KFH12N-04S	22		39.4	32.6						
		ø9	ø8	R1/4	KFH12B-02S	17		32.1	29.1	15.5	8	45	33	
				R3/8	KFH12B-03S	17		32.5	29.5					
				R1/2	KFH12B-04S	22		35.7	32.6					

* Reference dimensions after installation of R thread.



Resin sleeve



Brass sleeve

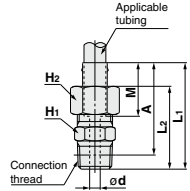

Dimensions

Male Elbow: KFL

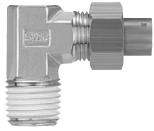

Resin sleeve



Brass sleeve

Applicable tubing size (mm)		Conne- tion thread	Model	Width across flats		L ₁	L ₂	L ₃	L ₄	M	ød	A*	Effective area (mm ²)	Weight (g)		
O.D.	I.D.			H ₁	H ₂											
ø4	ø2.5	R1/8	KFL04-01S	10	10	27.5	20.8	17	13	15.5	1.5	19.3	1.6	21		
		R1/4	KFL04-02S											19	25	
		R1/8	KFL04B-01S											17	22	
		R1/4	KFL04B-02S											19	26	
ø6	ø4	R1/8	KFL06-01S	10	12	27.2	20.5	17	13	15.2	3	19.3	6.0	22		
		R1/4	KFL06-02S											19	27	
		R3/8	KFL06-03S	12	12	30.2	23.5	20	13.7	3	21	19.3	6.0	38		
		R1/8	KFL06B-01S											17	23	
		R1/4	KFL06B-02S	10	12	24.2	21.2	19	13	12.2	3	21	19.3	6.0	28	
		R3/8	KFL06B-03S												12	39
ø8	ø5	R1/8	KFL08U-01S	12	14	28.2	21.5	18	14	16.2	4	21.3	11	9.5		
		R1/4	KFL08U-02S											21	32	
		R3/8	KFL08U-03S											20	31	
		R1/8	KFL08N-01S											18	39	
	ø6	R1/4	KFL08N-02S	12	14	28.2	21.5	18	14	13.3	5	21.3	12	16	31	
		R3/8	KFL08N-03S												21	37
		R1/8	KFL08B-01S												25.3	32
		R1/4	KFL08B-02S												21	33
R3/8	KFL08B-03S	12	14	27.3	24.3	20	13.7	21	16.8	6.5	23.3	18	38	38		
R1/4	KFL10U-02S													22	44	
ø10	ø6.5	R3/8	KFL10U-03S	14	17	31.8	24.5	22	16	18.8	5.5	22	20	66		
		R1/2	KFL10U-04S											25	68	
		R1/4	KFL10N-02S											22	38	
		R3/8	KFL10N-03S											21	43	
	ø7.5	R1/2	KFL10N-04S	14	17	33.8	26.5	25	16.8	15.0	6.5	25.3	23	26	65	
		R1/4	KFL10B-02S												22	39
		R3/8	KFL10B-03S												28.0	44
		R1/2	KFL10B-04S												30.0	66
ø12	ø8	R1/4	KFL12U-02S	14	19	34.3	27.5	23	17	19.3	7	24.2	30	24		
		R3/8	KFL12U-03S											22	53	
		R1/2	KFL12U-04S											25	68	
		R1/4	KFL12N-02S											23	51	
	ø9	R3/8	KFL12N-03S	14	19	34.3	27.5	22	15.7	15.5	8	24.2	35	27	52	
		R1/2	KFL12N-04S												25	67
		R1/4	KFL12B-02S												23	53
		R3/8	KFL12B-03S												30.6	54
R1/2	KFL12B-04S	14	19	30.6	27.6	22	15.7	25	16.8	8	24.2	35	27	69		
R1/2	KFL12B-04S													25	69	

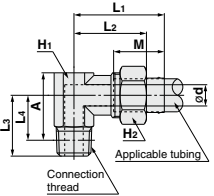

* Reference dimensions after installation of R thread.

- KQ2
- KQB2
- KS
- KX
- KM
- KF**
- M
- H/DL
- L/LL
- KC
- KK
- KK130
- DM
- KDM
- KB
- KR
- KA
- KQG2
- KG
- KFG2
- MS
- KKA
- KP
- LQ
- MQR
- T
- IDK

KF Series

Dimensions

Straight Union: KFH



Resin sleeve



Brass sleeve

Applicable tubing size (mm)		Model	Width across flats		L ₁	L ₂	M	ød	Effective area (mm ²)	Weight (g)
O.D.	I.D.		H ₁	H ₂						
ø4	ø2.5	KFH04-00	8	10	40.9	27.6	15.5	1.5	1.6	13
		KFH04B-00			34.7	28.8	12.4			14
ø6	ø4	KFH06-00	10	12	40.3	27	15.2	3	6	17
		KFH06B-00			34.3	28.4	12.2			19
ø8	ø5	KFH08U-00	12	14	41.3	28	16.2	4	11	23
		KFH08N-00			35.5	29.6	13			22
ø8	ø6	KFH08N-00	12	14	41.3	28	16.2	5	17	22
		KFH08B-00			35.5	29.6	13			24
ø10	ø6.5	KFH10U-00	17	17	44.6	30	18.8	5.5	21	36
		KFH10N-00			37.0	31.0	15.0			39
ø10	ø7.5	KFH10N-00	17	17	44.6	30	18.8	6.5	30	36
		KFH10B-00			37.0	31.0	15.0			39
ø12	ø8	KFH12U-00	17	19	45.5	32	19.3	7	35	42
		KFH12N-00			38.1	32.2	15.5			41
ø12	ø9	KFH12N-00	17	19	45.5	32	19.3	8	45	41
		KFH12B-00			38.1	32.2	15.5			44

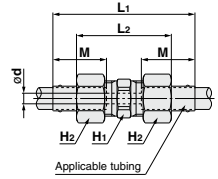

Tee Union: KFT



Resin sleeve



Brass sleeve

Applicable tubing size (mm)		Model	Width across flats		L ₁	L ₂	M	ød	Effective area (mm ²)	Weight (g)
O.D.	I.D.		H ₁	H ₂						
ø4	ø2.5	KFT04-00	10	10	27.5	20.8	15.5	1.5	1.6	33
		KFT04B-00			24.4	21.4	12.4			35
ø6	ø4	KFT06-00	10	12	27.2	20.5	15.2	3	6	37
		KFT06B-00			24.2	21.2	12.2			39
ø8	ø5	KFT08U-00	12	14	30.2	23.5	16.2	4	11	54
		KFT08N-00			27.3	24.3	13.3			53
ø8	ø6	KFT08N-00	12	14	30.2	23.5	16.2	5	17	53
		KFT08B-00			27.3	24.3	13.3			56
ø10	ø6.5	KFT10U-00	12	17	31.8	24.5	18.8	5.5	21	65
		KFT10N-00			28.0	25.0	15.0			63
ø10	ø7.5	KFT10N-00	12	17	31.8	24.5	18.8	6.5	30	63
		KFT10B-00			28.0	25.0	15.0			67
ø12	ø8	KFT12U-00	14	19	34.3	27.5	19.3	7	35	89
		KFT12N-00			30.6	27.6	15.5			85
ø12	ø9	KFT12N-00	14	19	34.3	27.5	19.3	8	45	85
		KFT12B-00			30.6	27.6	15.5			90

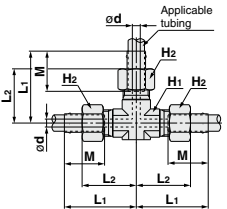

Dimensions

Branch Tee: KFT



Resin sleeve



Brass sleeve

Applicable tubing size (mm)		Connection thread R	Model	Width across flats		L ₁	L ₂	L ₃	L ₄	M	ød	A*	Effective area (mm ²)	Weight (g)													
O.D.	I.D.			H ₁	H ₂																						
ø4	ø2.5	R1/8	KFT04-01S	10	10	27.5	20.8	17	13	15.5	1.5	19.3	3	29													
		R1/4	KFT04-02S					19						34													
		R1/8	KFT04B-01S					17						30													
		R1/4	KFT04B-02S					19						35													
ø6	ø4	R1/8	KFT06-01S	10	10	27.2	20.5	17	13	15.2	3	19.3	10	32													
		R1/4	KFT06-02S					19						37													
		R3/8	KFT06-03S	12	12	30.2	23.5	22	15.7	3	19.3	10	34														
		R1/4	KFT06B-02S	10	10	24.2	21.2	19	13					12.2	19.3	10	39										
		R3/8	KFT06B-03S	12	12	27.2	24.2	22	15.7	3	19.3	12	55														
		R1/8	KFT08U-01S	12	14	30.2	23.5	20	16					16.2	23.3	14	49										
R1/4	KFT08U-02S	23	17					24.3	19	50																	
R3/8	KFT08U-03S	22	15.7					23	56																		
R1/8	KFT08N-01S	20	16					23.3	16	46																	
R1/4	KFT08N-02S	23	17					24.3	19	49																	
R3/8	KFT08N-03S	22	15.7					23	54																		
ø8	ø6	R1/8	KFT08B-01S	12	14	27.3	24.3	20	13.3	23.3	16	46															
		R1/4	KFT08B-02S					23					17	24.3	25	49											
		R3/8	KFT08B-03S					22					15.7	23	58												
		R1/8	KFT08B-01S					20					16	23.3	16	46											
		R1/4	KFT08B-02S					23					17	24.3	25	51											
		R3/8	KFT08B-03S					22					15.7	23	56												
ø10	ø6.5	R1/4	KFT10U-02S	12	17	31.8	24.5	23	18.8	18.8	5.5	24.3	27	46													
		R3/8	KFT10U-03S					22						15.7	23	63											
		R1/2	KFT10U-04S					14						14	33.8	26.5	27	18.8	27.3	34	90						
	ø7.5	R1/4	KFT10N-02S	12	17	31.8	24.5	23	17	18.8	18.8	6.5	24.3	30	57												
		R3/8	KFT10N-03S					22							15.7	23	62										
		R1/2	KFT10N-04S					14							14	33.8	26.5	27	18.8	27.3	41	88					
		R1/4	KFT10B-02S					12							17	28.0	25.0	23	17	15.0	24.3	30	60				
		R3/8	KFT10B-03S															22						15.7	23	65	
		R1/2	KFT10B-04S															14						14	30.0	27.0	27
		ø12	ø8					R1/4							KFT12U-02S	14	19	34.3	27.5	25	19.3	19.3	7	26.2	44	79	
R3/8	KFT12U-03S			24	17.7	27.3	81																				
R1/2	KFT12U-04S			27	18.8	27.3	94																				
ø9	R1/4		KFT12N-02S	14	19	30.6	27.6	25	15.5	15.5	8	27.5	32	75													
	R3/8		KFT12N-03S					24							17.7					26.2						48	78
	R1/2		KFT12N-04S					27							18.8					27.3						93	
	R1/4		KFT12B-02S					25							19					27.5						32	78
	R3/8		KFT12B-03S					24							17.7					26.2						48	81
	R1/2		KFT12B-04S					27							18.8					27.3						96	

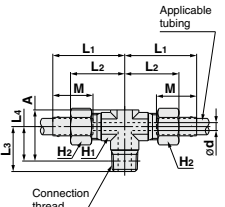

- KQ2
- KQB2
- KS
- KX
- KM
- KF**
- M
- H/DL
- L/LL
- KC
- KK
- KK130
- DM
- KDM
- KB
- KR
- KA
- KQG2
- KG
- KFG2
- MS
- KKA
- KP
- LQ
- MQR
- T
- IDK

* Reference dimensions after installation of R thread.

KF Series

Dimensions

Female Union: KFF

Applicable tubing size (mm)		Connection thread Rc	Model	Width across flats			L ₁	L ₂	L ₃	M	ød	Effective area (mm ²)	Weight (g)		
O.D.	I.D.			H ₁	H ₂	H ₃									
ø4	ø2.5	Rc1/4	KFF04-02	17	10	33.5	26.8	15	15.5	1.5	1.6	25			
			KFF04B-02										30.4	27.4	12.4
ø6	ø4	Rc1/4	KFF06-02	17	12	33.2	26.5	15	15.2	3	6	27			
			KFF06B-02										35.2	28.5	17
			KFF06-03										30.2	27.2	15
			KFF06B-03										32.2	29.2	17
ø8	ø5	Rc1/4	KFF08U-02	17	14	33.2	26.5	15	16.2	4	11	28			
			KFF08B-02										30.3	27.3	13.3
ø10	ø6.5	Rc1/4	KFF10U-02	17	17	34.8	27.5	15	18.8	5.5	21	32			
			KFF10N-02										31.0	28.0	15.0
			KFF10B-02										31.0	28.0	15.0
ø12	ø8	Rc1/4	KFF12U-02	17	19	35.3	28.5	15	19.3	7	35	35			
			KFF12N-02										31.6	28.6	15.5
			KFF12B-02										31.6	28.6	15.5

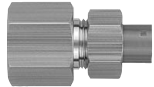

Resin sleeve

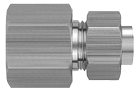

Brass sleeve

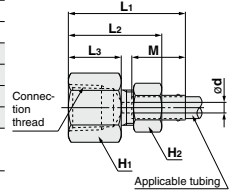

Bulkhead Connector: KFE

Applicable tubing size (mm)		Connection thread Rc	Model	Width across flats			L ₁	L ₂	L ₃	M	ød	T ₂	Mounting hole	Effective area (mm ²)	Weight (g)			
O.D.	I.D.			H ₁	H ₂	H ₃												
ø6	ø4	Rc1/4	KFE06-02	17	12	17	44.2	37.5	16	15.2	3	M10 x 1	11	6	41			
			KFE06B-02													41.2	38.2	12.2
ø8	ø5	Rc3/8	KFE08U-03	19	14	19	46.2	39.5	17	16.2	4	M12 x 1	13	11	49			
			KFE08N-03													43.3	40.3	13.3
			KFE08B-03													43.3	40.3	13.3
			KFE08-03													43.3	40.3	13.3
ø10	ø6.5	Rc3/8	KFE10U-03	19	17	22	48.8	41.5	17	18.8	5.5	M15 x 1	16	21	63			
			KFE10N-03													45.0	42.0	15.0
			KFE10B-03													45.0	42.0	15.0
ø12	ø8	Rc3/8	KFE12U-03	22	19	24	51.3	44.5	17	19.3	7	M17 x 1	18	35	93			
			KFE12N-03													47.6	44.6	15.5
			KFE12B-03													47.6	44.6	15.5

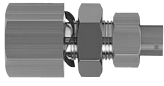

Resin sleeve

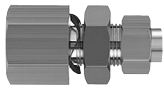

Brass sleeve

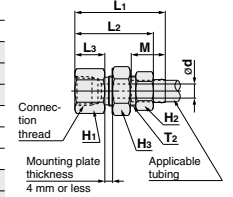

Bulkhead Union: KFE

Applicable tubing size (mm)		Model	Width across flats			L ₁	L ₂	M	ød	Mounting hole	Effective area (mm ²)	Weight (g)			
O.D.	I.D.		H ₁	H ₂	H ₃										
ø4	ø2.5	KFE04-00	12	10	13	50.9	37.6	15.5	1.5	9	1.6	23			
		KFE04B-00											44.7	38.8	12.4
ø6	ø4	KFE06-00	14	12	17	51.3	38	15.2	3	11	6	34			
		KFE06B-00											45.3	39.4	12.2
ø8	ø5	KFE08U-00	17	14	19	52.3	39	16.2	4	13	11	47			
		KFE08N-00											46.5	40.6	13
		KFE08B-00											46.5	40.6	13
ø10	ø6.5	KFE10U-00	19	17	22	56.6	42	18.8	5.5	16	21	67			
		KFE10N-00											49.0	43.0	15.0
		KFE10B-00											49.0	43.0	15.0
ø12	ø8	KFE12U-00	22	19	24	59.5	46	19.3	7	18	35	87			
		KFE12N-00											52.1	46.2	15.5
		KFE12B-00											52.1	46.2	15.5



Resin sleeve



Brass sleeve

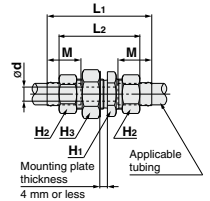

Dimensions

Male Run Tee: KFY



Resin sleeve



Brass sleeve

Applicable tubing size (mm)		Conne- tion thread R	Model	With across flats		L ₁	L ₂	L ₃	L ₄ *	M	ød	A*	Effective area (mm ²)	Weight (g)									
O.D.	I.D.			H ₁	H ₂																		
ø4	ø2.5		R1/8	KFY04-01S	10	10	27.5	20.8	17	13	15.5	40.5	3.5	28									
			R1/4	KFY04-02S											24.4	21.4	19	12.4	37.4	32			
			R1/8	KFY04B-01S																	17	19	33
			R1/4	KFY04B-02S																			
ø6	ø4		R1/8	KFY06-01S	10	12	27.2	20.5	19	13	15.2	40.2	11	31									
			R1/4	KFY06-02S											12	30.2	23.5	22	15.7	46.8	13	51	
			R3/8	KFY06-03S	10	12	24.2	21.2	19	13	12.2	37.2	11	33									
			R1/4	KFY06B-02S											12	27.2	24.2	22	15.7	42.8	13	53	
			R3/8	KFY06B-03S																			
			ø8	ø5		R1/8	KFY08U-01S	12	14	30.2	23.5	20	16	16.2	46.2	15	48						
R1/4	KFY08U-02S	23				17	47.2											21	50				
R3/8	KFY08U-03S																			22	15.7	45.8	18
R1/8	KFY08N-01S	20				16	43.3											18	49				
R1/4	KFY08N-02S																			23	17	47.2	27
R3/8	KFY08N-03S	22				15.7	45.8											53					
ø6				R1/8	KFY08B-01S			12	14	27.3	24.3	20	16	13.3	44.3	18	49						
		R1/4		KFY08B-02S	23	17	44.3											27	50				
		R3/8		KFY08B-03S																22	15.7	42.9	55
		R1/8		KFY08B-01S	23	17	43.3											18	49				
		R1/4		KFY08B-02S																23	17	44.3	27
		R3/8		KFY08B-03S	22	15.7	42.9											55					
ø10	ø6.5		R1/4	KFY10U-02S				12		31.8	24.5	22	15.7	18.8	48.8	30	58						
			R3/8	KFY10U-03S	14	17	33.8											26.5	27	18.8	52.6	89	
			R1/2	KFY10U-04S																			23
			R1/4	KFY10N-02S	31.8	24.5	22											15.7	47.4	46	62		
	R3/8	KFY10N-03S	12	17				28.0	25.0	22	15.7	43.6	46	65									
	R1/2	KFY10N-04S			14		30.0								27.0	27	18.8	48.8	46	91			
	ø12	ø7.5		R1/4				KFY10B-02S	12		28.0	25.0	22	15.7							15.0	43.6	46
				R3/8	KFY10B-03S	14		30.0							27.0	27	18.8	48.8	46	91			
R1/2				KFY10B-04S	23																		
R1/4				KFY10B-02S		33.8	26.5	27							18.8	52.6	88						
R3/8		KFY10B-03S	12	17	28.0				25.0	22	15.7	43.6	46	65									
R1/2		KFY10B-04S				14		30.0							27.0	27	18.8	48.8	46	91			
ø12		ø8		R1/4	KFY12U-02S				14	19	34.3	27.5	25	19							19.3	53.3	34
				R3/8	KFY12U-03S	24	17.7	51.9							49	93							
	R1/2			KFY12U-04S	27												18.8	53.1	96				
	R1/4			KFY12N-02S		25	19	53.3							36	76							
	R3/8	KFY12N-03S	24	17.7	51.9				54	78													
	R1/2	KFY12N-04S				27	18.8	53.1			92												
	ø9		R1/4	KFY12B-02S	14				19	30.6		27.6	25	19	15.5	49.6	36	79					
			R3/8	KFY12B-03S		24	17.7	48.2			54								81				
R1/2			KFY12B-04S	27																18.8	49.4	54	95
R1/4			KFY12B-02S			25	19	49.6			36								79				
R3/8	KFY12B-03S	24	17.7	48.2	54				81														
R1/2	KFY12B-04S					27	18.8	49.4		54	95												

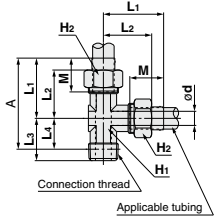

* Reference dimensions after installation of R thread.

- KQ2
- KQB2
- KS
- KX
- KM
- KF**
- M
- H/DL
- L/LL
- KC
- KK
- KK130
- DM
- KDM
- KB
- KR
- KA
- KQG2
- KG
- KFG2
- MS
- KKA
- KP
- LQ
- MQR
- T
- IDK

KF Series

Dimensions

Swivel Elbow: KFV



Resin sleeve



Brass sleeve

Applicable tubing size (mm)		Connection thread R	Model	Width across flats				L1	L2	L3	L4*	M	ød	A*	Effective area (mm ²)	Weight (g)						
O.D.	I.D.			H1	H2	H3	H4															
ø4	ø2.5		R1/8	10	10	14	10	19.3	32.8	29.7	15.5		35.5	1.4		40						
			R1/4													KFV04-02S	14	37.5	31.7	50		
			R1/8													KFV04B-01S	10	32.8	29.7	41		
			R1/4													KFV04B-02S	14	22.9	19.9	12.4	35.5	51
			R1/8													KFV06-01S	10	32.8	29.7	36.6	42	
ø6	ø4		R1/4	10	12	14	10	19	37.2	31.7	15.2		38.6	5		52						
			R3/8													KFV06-03S	17	37.6	32.4	64		
			R1/8													KFV06B-01S	10	32.8	29.7	36.6	43	
			R1/4													KFV06B-02S	14	22.7	19.7	12.2	38.6	53
			R3/8													KFV06B-03S	17	37.6	32.4	39.3	65	
ø8	ø5		R1/8	12	14	17	12	20.5	38.8	30.7	16.2		40.8	9.4		52						
			R1/4													KFV08U-02S	14	38.2	32.7	61		
			R3/8													KFV08U-03S	17	38.6	33.4	73		
	ø6		R1/8				KFV08N-01S	12	27.2	38.8	30.7	38.8	57									
			R1/4				KFV08N-02S	14	38.2	32.7	40.8	60										
			R3/8				KFV08N-03S	17	38.6	33.4	41.5	72										
			R1/8				KFV08B-01S	12	33.8	30.7	38.8	58										
			R1/4				KFV08B-02S	14	24.3	21.3	13.3	40.8	61									
			R3/8				KFV08B-03S	17	38.6	33.4	41.5	73										
ø10	ø6.5		R1/4	14	17	19	17	21.5	40.2	34.7	18.8		44.5	18		73						
			R3/8													KFV10U-03S	22	40.6	35.4	81		
			R1/2													KFV10U-04S	22	43.8	36.5	104		
	ø7.5		R1/4				KFV10N-02S	17	28.8	40.2	34.7	44.5	72									
			R3/8				KFV10N-03S	17	40.6	35.4	45.2	80										
			R1/2				KFV10N-04S	22	43.8	36.5	46.3	104										
			R1/4				KFV10B-02S	17	40.2	34.7	44.5	73										
			R3/8				KFV10B-03S	17	25.0	22.0	15.0	45.2	81									
			R1/2				KFV10B-04S	22	43.8	36.5	46.3	105										
ø12	ø8		R1/4	17	19	22	17	23.5	41.2	35.7	19.3		46.7	30		92						
			R3/8													KFV12U-03S	22	41.6	36.4	100		
			R1/2													KFV12U-04S	22	44.8	37.5	124		
	ø9		R1/4				KFV12N-02S	17	30.3	41.2	35.7	46.7	90									
			R3/8				KFV12N-03S	17	41.6	36.4	47.4	98										
			R1/2				KFV12N-04S	22	44.8	37.5	48.5	123										
			R1/4				KFV12B-02S	17	41.2	35.7	46.7	92										
			R3/8				KFV12B-03S	17	26.6	23.6	15.5	47.4	100									
			R1/2				KFV12B-04S	22	44.8	37.5	48.5	125										

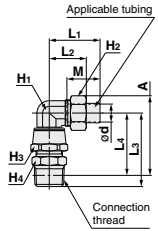

* Reference dimensions after installation of R thread.

Dimensions

Swivel Long Elbow: KFW



Resin sleeve



Brass sleeve

Applicable tubing size (mm)		Connection thread R	Model	Width across flats				L ₁	L ₂	L ₃	L ₄ *	M	ød	A*	Effective area (mm ²)	Weight (g)	
O.D.	I.D.			H ₁	H ₂	H ₃	H ₄										
ø4	ø2.5	R/8	KFW04-01S	10	10	14	10	26	19.3	52.8	49.7	15.5	55.5	1.4	58		
		R1/4	KFW04-02S				14									57.2	51.7
		R/8	KFW04B-01S	10	22.9	19.9	10	52.8	49.7	12.4	57.2	51.7	15.5	55.5	64		
		R1/4	KFW04B-02S	14			57.2									51.7	
		ø6	ø4	R/8	KFW06-01S	10	12	14	10	25.7	19.0	53.8	50.7	15.2	57.6	5.0	61
R1/4	KFW06-02S			14	58.2				52.7								
R/8	KFW06-03S			10	22.7	19.7	10	53.8	50.7	12.2	58.2	52.7	15.2	57.6	67		
R1/4	KFW06B-02S			14			58.2									52.7	
R/8	KFW06B-03S			10	27.2	20.5	10	54.8	51.7	16.2	58.6	53.4	15.2	60.3	78		
R1/4	KFW06B-01S			14			58.6									53.4	
ø8	ø6			R/8	KFW08U-01S	12	14	17	12	24.3	21.3	54.8	51.7	13.3	59.8	14	81
				R1/4	KFW08U-02S				14								
				R/8	KFW08U-03S	12	27.2	20.5	12	59.6	54.4	16.2	59.8	51.7	15.2	62.5	90
		R1/4	KFW08N-01S	14	54.8	51.7											
		R/8	KFW08N-02S	12	24.3	21.3	12	59.2	53.7	13.3	61.8	53.7	15.2	59.8	82		
		R1/4	KFW08B-01S	14			59.2									53.7	
		ø10	ø6.5	R/8	KFW08B-03S	14	17	19	12	25.0	22.0	59.6	54.4	15.0	62.5	18	89
				R1/4	KFW10U-02S				14								
				R/8	KFW10U-03S	14	28.8	21.5	14	61.2	55.7	18.8	61.6	56.4	15.5	65.5	25
R1/2	KFW10U-04S			17	64.8	57.5											
R/8	KFW10N-02S			14	25.0	22.0	14	61.2	55.7	15.0	61.6	56.4	15.5	66.2	104		
R1/4	KFW10N-03S			17			61.2									55.7	
R/8	KFW10B-02S			14	30.3	23.5	14	64.2	58.7	19.3	64.8	57.5	15.5	65.5	126		
R1/2	KFW10B-04S			22			64.8									57.5	
ø12	ø8			R/8	KFW10B-03S	17	19	22	14	26.6	23.6	64.2	58.7	15.5	69.7	30	146
		R1/4	KFW12U-02S	17	64.2				58.7								
		R/8	KFW12U-03S	17	30.3	23.5	17	64.6	59.4	19.3	64.2	58.7	15.5	70.4	146		
		R1/2	KFW12U-04S	22			67.8									60.5	
		R/8	KFW12N-02S	17	26.6	23.6	17	64.2	58.7	15.5	64.6	59.4	15.5	69.7	144		
		R1/4	KFW12N-03S	22			64.2									58.7	
		R/8	KFW12N-04S	17	22	19	22	17	67.8	60.5	8	71.5	38	145			
		R1/2	KFW12B-02S	22				67.8							60.5		
		R/8	KFW12B-03S	17	26.6	23.6	17	64.2	58.7	15.5	70.4	59.4	15.5	71.5	147		
R1/4	KFW12B-04S	22	64.2	58.7													
R/8	KFW12B-03S	17	22	19	22	17	67.8	60.5	8	71.5	38	159					
R1/2	KFW12B-04S	22				67.8							60.5				

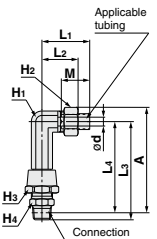

* Reference dimensions after installation of R thread.

Plug: KFP



(mm)				
Applicable tubing size (mm)	Model	L ₁	ød	Weight (g)
ø4	KFP-04	12	6.5	0.3
ø6	KFP-06	12	8.5	0.5
ø8	KFP-08	12	10.4	0.7
ø10	KFP-10	13.5	13	1.0
ø12	KFP-12	14	15	1.4



- KQ2
- KQB2
- KS
- KX
- KM
- KF
- M
- H/DL
- L/LL
- KC
- KK
- KK130
- DM
- KDM
- KB
- KR
- KA
- KQG2
- KG
- KFG2
- MS
- KKA
- KP
- LQ
- MQR
- T
- IDK

KF Series

Dimensions

Elbow Connector: KFB



Applicable tubing size (mm)		Model	Width across flats		L ₁	L ₂	ød	Weight (g)
O.D.	I.D.		H ₁	H ₂				
ø4	ø2.5	KFB-04	10	14	18.5	18.5	1.5	21.1
ø6	ø4	KFB-06	10	14	18.5	18.5	3	21.6
ø8	ø5	KFB-08U	12	17	20	19.5	4	32.8
	ø6	KFB-08N					5	32.9
ø10	ø6.5	KFB-10U	14	19	21	21.5	5.5	41.9
	ø7.5	KFB-10N					6.5	41.7
ø12	ø8	KFB-12U	17	22	22	22.5	7	61.8
	ø9	KFB-12N					8	61.6

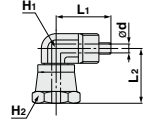

Long Elbow Connector: KFW



Applicable tubing size (mm)		Model	Width across flats		L ₁	L ₂	ød	Weight (g)
O.D.	I.D.		H ₁	H ₂				
ø4	ø2.5	KFW-04	10	14	18.5	38.5	1.5	31.7
ø6	ø4	KFW-06	10	14	18.5	39.5	3	33.0
ø8	ø5	KFW-08U	12	17	20	40.5	4	48.0
	ø6	KFW-08N					5	46.8
ø10	ø6.5	KFW-10U	14	19	21	42.5	5.5	62.4
	ø7.5	KFW-10N					6.5	63.4
ø12	ø8	KFW-12U	17	22	22	45.5	7	94.0
	ø9	KFW-12N					8	94.5

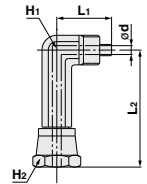

Sleeve: KFS



Resin sleeve



Brass sleeve

Applicable tubing size (mm)		Model	L	øD	Weight (g)
ø4	KFS-04				
	KFSB-04	8.7	0.6		
ø6	KFS-06	12	8.5	0.1	
	KFSB-06	8.8		0.9	
ø8	KFS-08	12	10.5	0.2	
	KFSB-08	8.8		1.2	
ø10	KFS-10	13.5	13	0.3	
	KFSB-10	9.6		1.7	
ø12	KFS-12	14	15	0.4	
	KFSB-12	10.1		2.1	



Union Nut: KFN



Applicable tubing size (mm)		Model	Width across flats		Weight (g)
			H	L	
ø4	KFN-04	10	8	3.0	
ø6	KFN-06	12	8	3.8	
ø8	KFN-08	14	8	4.7	
ø10	KFN-10	17	9	7.0	
ø12	KFN-12	19	10	9.5	

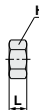



KF Series

Specific Product Precautions 1

Be sure to read this before handling the products.

Refer to back page 50 for Safety Instructions and pages 13 to 17 for Fittings and Tubing Precautions.

Selection

⚠ Caution

1. Please consult with SMC regarding fluids other than air and steam.

Piping

⚠ Caution

1. Installation of tubing
 - 1) Take a tube having no flaws on its periphery and cut it off at right angles. Do not use pinchers, nippers or scissors, etc. The tubing might be cut diagonally or flattened, making installation impossible or causing problems such as disconnection and leakage.
 - 2) Without loosening the union nut, grab the tube and gently push it thoroughly into the fitting.
 - 3) After insertion, confirm that the tube will not disconnect.

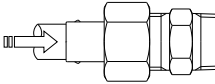

- 4) When the union is loose, tighten it additionally, temporarily by hand.
- 5) After fixing the body with the tightening tool, tighten the union nut with an appropriate wrench, applying the torque as shown below. After tightening the clearance between the union nut and the body in the axial direction is about 2 mm.

Fitting size	Sleeve material			
	Resin		Brass	
	Appropriate tightening rotations	Equivalent tightening torque (N·m)	Appropriate tightening rotations	Equivalent tightening torque (N·m)
KF□04	1.5 to 2.0	2 to 7	1.5	2 to 4
KF□06	1.5 to 2.0	3 to 8	1.5	4 to 6
KF□08	1.5 to 2.0	4 to 9	1.5	6 to 9
KF□10	1.5 to 2.0	6 to 9	1.5	10 to 12
KF□12	1.5 to 2.0	9 to 12	1.5	10 to 12

Piping

⚠ Caution

2. How to connect elbow type connector
 - 1) First tighten by hand, then use an appropriate wrench to tighten 1/6 to 1/3 turns additionally. Refer to the table below for equivalent tightening torque.

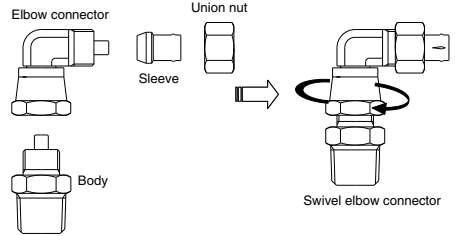

Fitting size	Appropriate tightening rotations	Equivalent tightening torque (N·m)
KF□-04	1/6 to 1/3	3 to 7
KF□-06	1/6 to 1/3	3 to 7
KF□-08	1/6 to 1/3	3 to 7
KF□-10	1/6 to 1/3	5 to 10
KF□-12	1/6 to 1/3	5 to 10

KQ2

KQB2

KS
KX

KM

KF

M

H/DL
L/LL

KC

KK

KK130

DM

KDM

KB

KR

KA

KQG2

KG

KFG2

MS

KKA

KP

LQ

MQR

T

IDK



KF Series

Specific Product Precautions 2

Be sure to read this before handling the products.

Refer to back page 50 for Safety Instructions and pages 13 to 17 for Fittings and Tubing Precautions.

Operating Environment

Warning

1. Do not use in environments or locations where there is a danger of damage to the fittings and tubing.
For fitting and tubing materials, refer to specifications and construction drawings, etc.

Maintenance

Caution

1. Pre-maintenance inspection
When the product is removed, turn off the power, cut off the supply pressure, and confirm that fluid in the piping has been discharged.
2. During regular maintenance, check for the following and replace any components as necessary.
 - a) Scratches, gouges, abrasion, corrosion
 - b) Leakage
 - c) Flattening or distortion of tubing
 - d) Hardening, deterioration or softness of tubing
3. Do not repair the fittings or patch the tubing for reuse.
4. Using this product for extended periods of time can result in leaks due to the material change. In such cases, tighten the union nut additionally.
A guide for the additional tightening is 1/6 to 1/4 turns. But in case of the brass sleeve, the limit for additional tightening is 1/2 turns.
When there is a leak even after additional tightening, replace the sleeve with new one.
5. Sleeve is not recyclable. Replace it every time piping is performed.