



RoHS

Foot Pedal Type 5 Port Mechanical Valve

XT34-60/67

- 5 port is added to the foot pedal type mechanical valve.
- Models with lock and without lock are available.

Model

Model	XT34-60	XT34-67
Lock	With lock	Without lock
Weight	0.8 kg	0.5 kg

Specifications

Fluid	Air/Inert gas		
Operating pressure	0.15 to 0.9 MPa		
Ambient and fluid temperature	-5 to 60°C (No freezing)		
Flow rate characteristics	C [dm ³ /(s·bar)]	b	Cv
1(P) → 2(B)/4(A)	0.76	0.22	0.17
2(B)/4(A) → 4(EB)/5(EA)	0.53	0.28	0.13
Lubrication	Not required (Use turbine oil Class 1 ISO VG32, if lubricated)		
Port size	Port 1(P), Port 2(B), Port 4(A): Rc1/8 Port 3(EB), Port 5(EA): M5 x 0.8		

XT34-60 (With lock)



Symbol

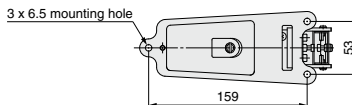
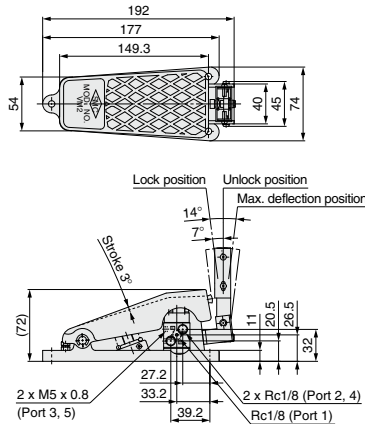
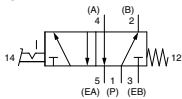

Travel required for operation	3°
Full Operating Force (F.O.F.)	55 N (at 0.5 MPa)
Travel required to release the lock	7°
Force required to release the lock (F.O.F.)	3.5 N

Operation

Locked

When stepping on the pedal, it is locked by the lock lever, and held in a locked state.

Unlocked

When pushing the lock lever with the toe, the lock is released, and the pedal returns to its original position.

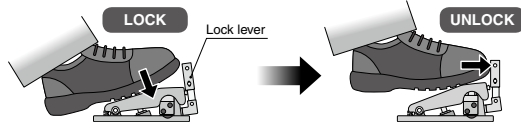

XT34-67 (Without lock)

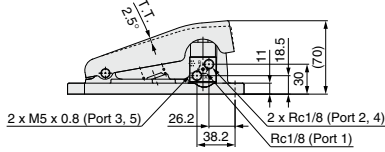
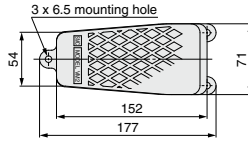

Symbol

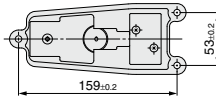
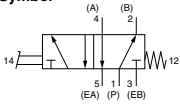

Total Travel (T.T.)	2.5°
Full Operating Force (Reference value)(F.O.F.)	55 N (at 0.5 MPa)