

Compact Vacuum Unit Ejector/Vacuum Pump System

ZB Series

New An IO-Link compatible pressure switch has been added.

- Allows for ejector control with a single communication line
- Reading of the device information and parameter batch settings are possible.



Quick response

Response time of the valve:

5 ms

Vacuum response time:

28 ms

Energy-saving

Air consumption: 17% reduced*

Vacuum pressure reached: 21% increased*

* Compared with existing model

(Shortened by **25%**;
Comparison with other SMC products)

* Conditions: Nozzle size $\phi 0.6$, when the pressure reaches -60 kPa, vacuum piping size $\phi 4/\phi 2.5 \times 50$ mm

Vacuum breaking time: 14 ms

* Conditions: Needle flow rate set to 10 L/min, when the pressure reaches atmospheric pressure, with supply pressure 0.5 MPa, vacuum piping size $\phi 4/\phi 2.5 \times 50$ mm

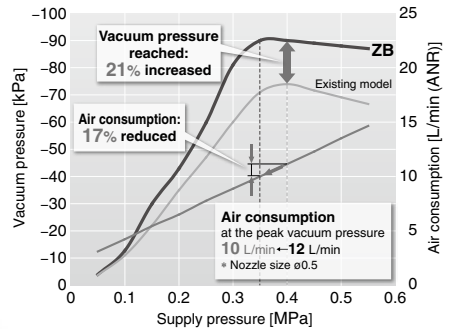

Compact/Lightweight

46 g

* Single unit weight

All-in-One

Supply valve, release valve, vacuum break flow adjustment needle, suction filter, and silencer

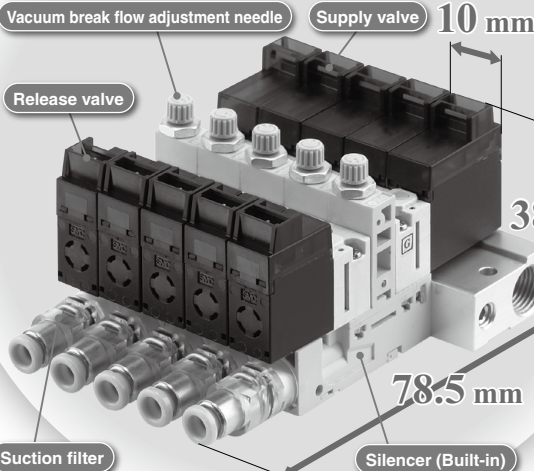

Nominal filtration rating: 30 μ m

With vacuum pressure switch

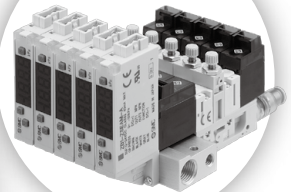

Set value can be copied up to **10 units.**

Reduction in setting work

Prevention of mistakes in setting

Source of copy



ZB Series

Unit with release pressure supply port can be selected.

Air pressure and release pressure can be adjusted separately.
Release pressure can be adjusted to suit the workpiece.

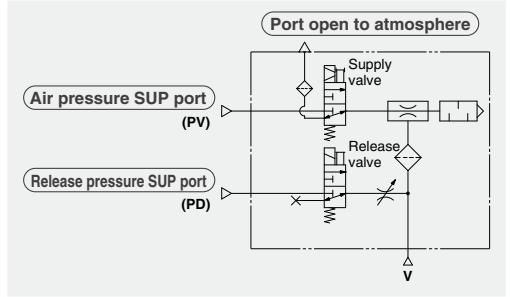
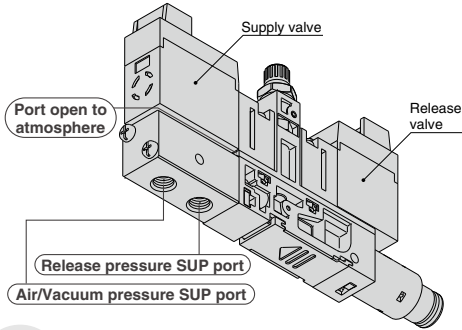

Release response time is shortened by 25% by the port open to atmosphere.

Having the R port of the supply valve allows instant vacuum break with the pump system and controls excessive increase of the release pressure.

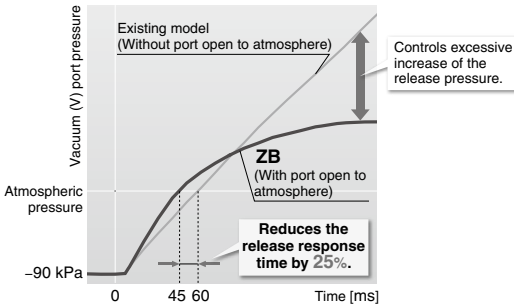

* Conditions: Needle flow rate set to 5 L/min, with supply pressure 0.5 MPa, vacuum piping size $\phi 4/\phi 2.5 \times 100$ mm

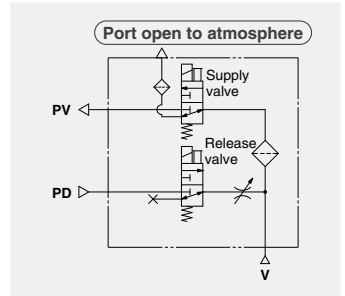

Prevents incorrect vacuum break (exhaust interference).

Installing individual exhaust ports prevents incorrect vacuum break due to exhaust interference when used as a manifold. Individual exhaust port specification for which piping can be connected is also available.

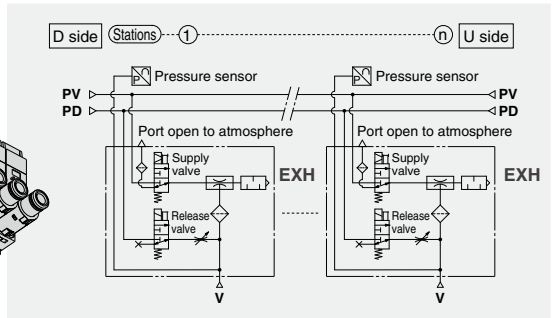
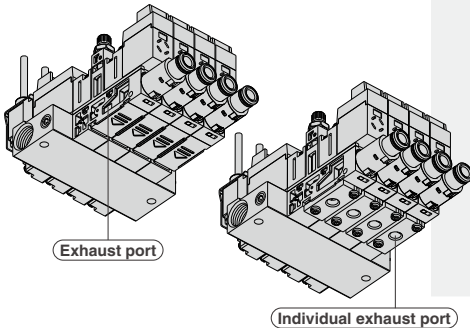

Easy maintenance

Simple installation and removal without the use of screws

■ Replacement of filter element

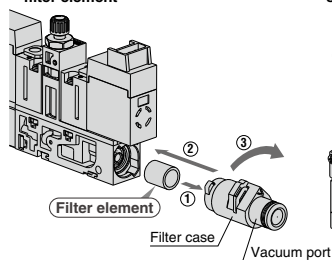

■ Replacement of sound absorbing material

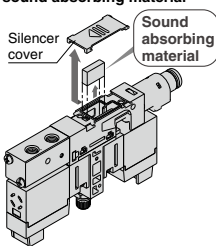

Fine adjustment of the vacuum break

It can be adjusted from 1 to 14.5 L/min (ANR).

* With the supply pressure 0.5 MPa

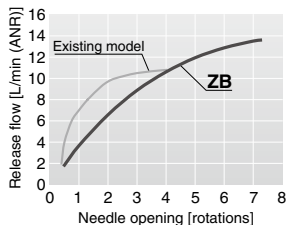

Unit either with pressure sensor or vacuum pressure switch can be selected.

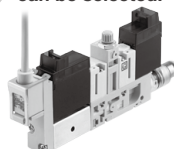

With pressure sensor

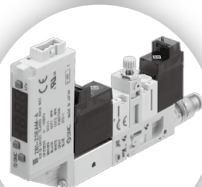

With vacuum pressure switch

Applicable to the latching type valve

Latching type can be selected for the supply valve. (Nozzle sizes: $\phi 0.3$ and $\phi 0.4$ only)

Reduces power consumption by reducing energization time when generating vacuum, and prevents workpieces being dropped if there is an instantaneous power cut due to lightning etc. (when the air supply is not stopped).

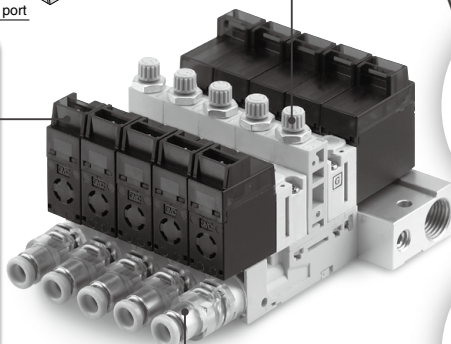

Construction which reduces discharge of dust with the vacuum break air

This product has a construction with the vacuum pressure path and release pressure path separated, which reduces the amount of dust collected by the suction filter discharged to the atmosphere.

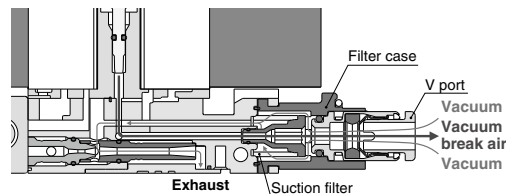

Application Example

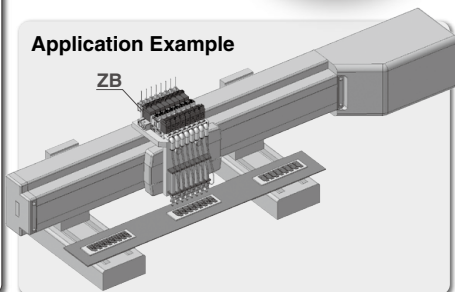

Single unit

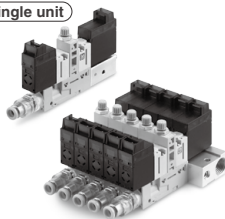

Manifold

Variations

Model	Nozzle size	Supply valve		Release valve	Pressure sensor	IO-Link compatible* vacuum pressure switch	Manifold stations
		Large flow (N.C.)	Latching*				
Vacuum pump system	ZB00	—	—	●	●	●	1 to 12 stations
Ejector	ZB03	$\phi 0.3$	●	—	●	—	
	ZB04	$\phi 0.4$	●	●	●	—	
	ZB05	$\phi 0.5$	●	—	●	●	
	ZB06	$\phi 0.6$	●	—	●	●	

* If the latching type supply valve is selected for the ZB03/04 ejector, the IO-Link compatible vacuum pressure switch cannot be selected.

IO-Link Compatible **ZB Series**

Visualization of operation/equipment status/Remote monitoring and control by communication

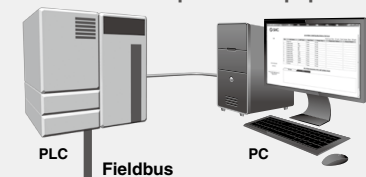

Configuration File (IODD File^{*1})
 • Manufacturer • Product part no. • Set value

^{*1} IODD File:
 IODD is an abbreviation of IO Device Description.
 This file is necessary for setting the device and connecting it to a master. Save the IODD file on the PC to be used to set the device prior to use.

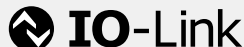

IO-Link is an open communication interface technology between the sensor/actuator and the I/O terminal that is an international standard. IEC 61131-9.

Device settings can be set by the master.

- Threshold value
- Operation mode, etc.

Read the device data.

- ON/OFF signal and analog value
- Device information:
 Manufacturer, Product part number, Serial number, etc.
- Normal or abnormal device status
- Cable breakage

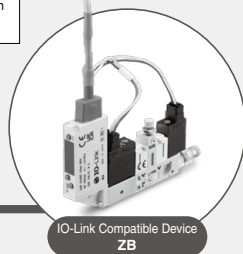

Implement diagnostic bits in the process data.

The diagnostic bit in the cyclic process data makes it easy to find problems with the equipment. It is possible to find problems with the equipment in real time using the cyclic (periodic) data and to monitor such problems in detail with the noncyclic (aperiodic) data.

- | | | |
|--|--|---|
| Error <ul style="list-style-type: none"> • OUT1/2 over current • Outside of zero-clear range • Temperature sensor failure • Master version mismatch | Warning <ul style="list-style-type: none"> • Valve protection warning • Energy saving operation warning | Pressure value diagnosis <ul style="list-style-type: none"> • Above the upper limit/ below the lower limit of the display range |
|--|--|---|

Input Process Data

Byte	1								0								
Bit offset	15	14	13	12	11	10	9	8	7	6	5	4	3	2	1	0	
Item	System error	Error	Valve warning	PD_IN forced output	Reservation				Pressure value diagnosis	Release valve output	Supply valve output	Reservation	Pressure confirmation	Pressure confirmation	Release confirmation	Energy saving confirmation	Suction confirmation
Byte	3								2								
Bit offset	31	30	29	28	27	26	25	24	23	22	21	20	19	18	17	16	
Item	Measured pressure value																

Process Data

Input process data	Output process data
4 bytes	2 bytes

Output Process Data

Byte	1								0							
Bit offset	15	14	13	12	11	10	9	8	7	6	5	4	3	2	1	0
Item	Reservation								Reservation							
									Automatic release forced OFF	Valve protection forced OFF	Energy saving control force Off	Energy saving force Off	Release instruction	Release instruction	Vacuum instruction	Vacuum instruction

Display function

Displays the output communication status and indicates the presence of communication data

Operation and Display

Communication with master	Status	Screen display	Description
Yes	Normal	Operate	Normal communication status (readout of measured value, command) * Output process data valid
			Normal communication status (readout of measured value) * Output process data invalid
		Start up	At the start of communication
			Preoperate
No	Abnormal	Version does not match	The IO-Link version does not match that of the master. ^{*2}
		Communication disconnection	Normal communication was not received for 1 s or longer.
	SIO mode ^{*3}		General switch output

^{*1} Displays the measured value ^{*2} When the product is connected to the master with version "V1.0," error E15 is generated. ^{*3} Cannot be used in SIO mode

Compact Vacuum Unit

ZB Series



How to Order Single Unit

Vacuum Pump System **ZB 00 2 0 - K1 5 L - P1 - C4**

Ejector System **ZB 04 1 1 - K1 5 L - P1 - C4**

IO-Link Compatible

Vacuum Pump System **ZB 00 2 0 - K1 5 LO - EL - C4**

Ejector System **ZB 04 1 1 - K1 5 LO - EL - C4**

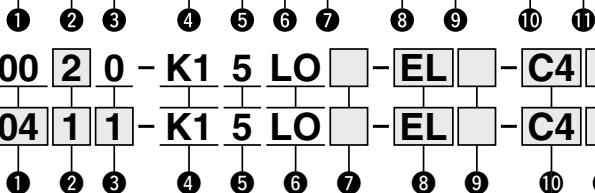

1 Nominal Nozzle Size

Symbol	Nominal nozzle size	Applicable supply valve and standard supply pressure	
		Large flow (N.C.)	Latching
00 ^{Note 1)}	—	●	—
03	ø0.3	● (0.35 MPa)	● (0.4 MPa)
04	ø0.4	● (0.35 MPa)	● (0.45 MPa)
05	ø0.5	● (0.35 MPa)	—
06	ø0.6	● (0.5 MPa)	—

Note 1) Vacuum pump system only

2 Body Type

Symbol	Body specification	Port specification ^{Note 2)}
1	Single unit	PV, PD common port (PV = PD)
2	Single unit	PV, PD individual port (PV ≠ PD)
3	For manifold	No distinction

Note 2) Names of the ports and functions are as follows.

PV: Air pressure SUP port (Ejector)
Vacuum pressure SUP port (Vacuum pump system)

PD: Release pressure SUP port
(For the unit with PD port, select the model with a release valve for ●.)

Specify the port specification of the body for manifold with the manifold model number.

5 Rated Voltage

5	24 VDC
6	12 VDC

6 Supply Valve/Release Valve Electrical Entry^{Note 4)}

L	L-type plug connector With lead wire	
LO	L-type plug connector Without connector	
M	M-type plug connector With lead wire ^{Note 5)}	
MO	M-type plug connector Without connector ^{Note 5)}	

Note 4) All with light and surge suppressor.

Lead wire length is 300 mm for the models with lead wire. For other lead wire length, select a model without connector and include the connector assembly part number in **Table 2** on page 692.

Note 5) M- and MO-type connectors cannot be selected for models with vacuum sensor or pressure switch for vacuum.

3 Exhaust Type

0	For vacuum pump system (Without silencer)		Without exhaust port
1	Silencer exhaust (Individual exhaust)		Exhaust direction
2	Port exhaust (Individual exhaust)		Exhaust port

4 Combination of Supply Valve and Release Valve^{Note 3)}

Symbol	Supply valve	Release valve	Applicable body type			
			Ejector		Pump system	
			PV = PD	PV ≠ PD	PV = PD	PV ≠ PD
K1	Normally closed	Normally closed	●	●	—	●
J1	Normally closed	None	●*	—	●*	—
Q1	Latching (Positive common)	Normally closed	●	●	—	—
Q2	Latching (Positive common)	None	●*	—	—	—

* Vacuum break by port open to atmosphere

Note 3) Refer to **Table 1** on page 692 for the part number of supply valve and release valve of each specification. Latching type is applicable only to the ejector nozzle sizes ø0.3 and ø0.4

7 Manual Override^{Note 6)}

Nil	Non-locking push type	
B	Locking type (Tool required) Semi-standard	

Note 6) Latching type (supply valve) has the push-locking type only, but either the push type or the locking type can be selected for the release valve.

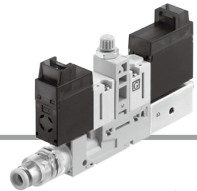

8 Pressure Sensor/Vacuum Pressure Switch Specifications

Symbol	Type	Pressure range [kPa]	Specifications	
Nll	Without pressure sensor/vacuum pressure switch			
P1	Pressure sensor	0 to -101	Output: 1 to 5 V, accuracy: $\pm 2\%$ F.S. or less ^{Note 8)}	
P3		-100 to 100	Output: 1 to 5 V, accuracy: $\pm 2\%$ F.S. or less ^{Note 8)}	
EA	Vacuum pressure switch ^{Note 7)}	0 to -101	NPN 2 outputs	With unit switching function ^{Note 9)}
EAM				SI unit only ^{Note 10)}
EAP			With unit switching function [Initial value psj] ^{Note 9)}	
EB			PNP 2 outputs	With unit switching function ^{Note 9)}
EBM				SI unit only ^{Note 10)}
EBP		With unit switching function [Initial value psj] ^{Note 9)}		
FA		-100 to 100	NPN 2 outputs	With unit switching function ^{Note 9)}
FAM				SI unit only ^{Note 10)}
FAP			With unit switching function [Initial value psj] ^{Note 9)}	
FB			PNP 2 outputs	With unit switching function ^{Note 9)}
FBM	SI unit only ^{Note 10)}			
FBP	With unit switching function [Initial value psj] ^{Note 9)}			
EL	0 to -101	IO-Link	With unit switching function ^{Note 9)}	
ELM			SI unit only ^{Note 10)}	
FL			With unit switching function ^{Note 9)}	
FLM			SI unit only ^{Note 10)}	

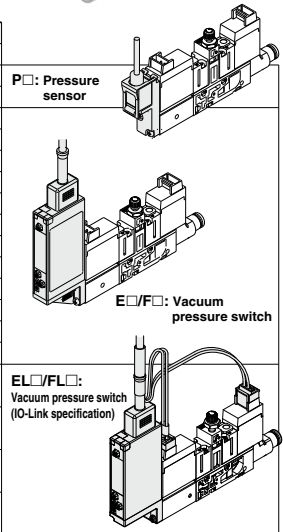

Note 7) The energy saving control cannot be used.
 Note 8) Only the lead wire length 3 m is available for the pressure sensor.
 Note 9) The unit switching function is not available in Japan due to a new measurement law.
 Note 10) Fixed unit: kPa

9 Lead Wire with Connector for Vacuum Pressure Switch

Nll	Without lead wire with connector (No need to specify for pressure sensor type.)
G	Lead wire with connector and connector cover, Lead wire length 2 m
H	Lead wire with connector for IO-Link (With M12 connector), Lead wire length 0.3 m

10 Vacuum (V) Port ^{Note 12)}

Symbol	Fitting	Metric size	Inch size	Notes
C2	Straight $\phi 2$ one-touch fitting			With suction filter ^{Note 11)}
C4	Straight $\phi 4$ one-touch fitting			
N1	Straight $\phi 1/8"$ one-touch fitting			
N3	Straight $\phi 5/32"$ one-touch fitting			With suction filter ^{Note 11)}
L2	Elbow $\phi 2$ one-touch fitting			
L4	Elbow $\phi 4$ one-touch fitting			
LN1	Elbow $\phi 1/8"$ one-touch fitting			
LN3	Elbow $\phi 5/32"$ one-touch fitting			

Note 11) The filter included in this product is of a simple type, and will become clogged quickly in environments with high quantities of dust or particulates. Please make additional use of an air suction filter of the ZFA, ZFB or ZFC series.

Note 12) Be sure to hold the filter case when connecting and disconnecting the tube for the elbow type.

⚠ Warning

The filter case of this suction filter is made of nylon. Contact with alcohol or similar chemicals may cause it to be damaged. Also, do not use the filter when these chemicals are present in the atmosphere.

11 Option ^{Note 13)}

Symbol	Description	Diagram
Nll	Without option	
B	With bracket for single unit (Enclosed with the product for shipment without being assembled)	
K	Screwdriver handling type vacuum break flow rate adjustment needle ^{Note 14)}	

Note 13) When multiple options are selected, state them in alphabetical order.

Note 14) Knob operated type is standard.

How to Order Manifold

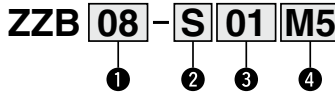

1 Stations

01	1 station
02	2 stations
⋮	⋮
12	12 stations

3 Common Supply (PV) Port Size

01	Rc1/8
01N	NPT1/8
01F	G1/8 (Note)
M5	M5 x 0.8

Note) G thread

Regarding thread ridge shape, it conforms to G thread standard (JIS B 0202), but it doesn't conform to ISO16030 and ISO1179 for the other shape.

2 Pressure Sensor/Vacuum Pressure Switch Mountable (Note)

Nil	Sensor/switch non-mountable base
S	Sensor/switch mountable base

Note) Select "S" when the model with either the pressure sensor or the vacuum pressure switch is selected in 3 for the single unit. (Refer to "Manifold" on page 700.)

4 Common Release Pressure (PD) Port Size (Note)

Nil	Without PD port (PV = PD)
M5	M5 x 0.8 (PV ≠ PD)

Note) Refer to 4 on page 684 for the combinations of supply valve and release valve selectable.

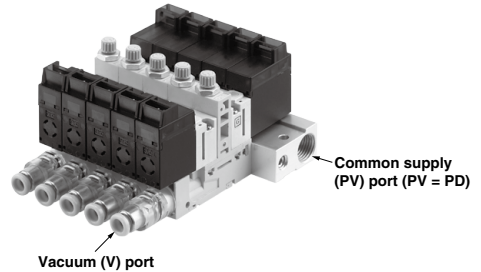

* Prepare a part to plug the unused port if the unit is used with an air supply on one side. Example) For M5 x 0.8: M-5P

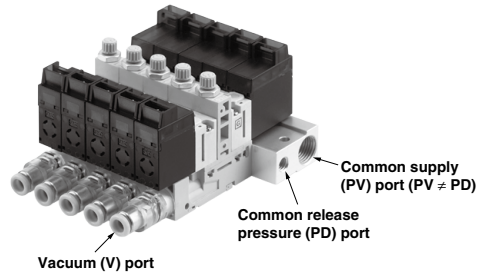

How to Order the Product

Single unit

Select the body type 1 or 2 referring to 2 Body type on page 1. (Example shows body type 1.)

Example) ZB04 1-K15L-P1-C4

Manifold

Refer to "How to Order Manifold" and select the body type 3 referring to 2 Body type on page 1. Pre-fix "*" to the part number for the single unit(s) to be mounted as a manifold. (Without "*", they will be shipped as a spare part and will not be mounted as a manifold.)

* The blanking plate assembly (Model: ZB1-BP2-A) can be mounted at portions where the single unit is not mounted. When ordering the product to be assembled into the base, specify an asterisk (*) indicating the assembly. (If an asterisk (*) is not specified, the product is not assembled into the base and is shipped separately.)

Example) ZZB08-011
 * ZB05 3-1-K15L-C44 (Stations 1 to 4)
 * ZB05 3-1-K15L-L43 (Stations 5 to 7)
 * ZB1-BP2-A1 (Stations 8)

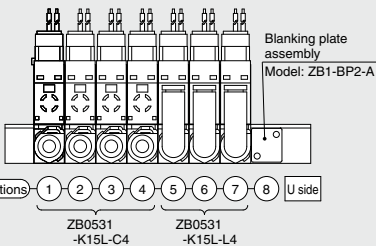

Manifold Maximum Simultaneous Operating Stations

Supply (PV) port Fitting size	Ejector model Supply valve type	ZB03		ZB04		ZB05		ZB06	
		Large flow (N.C.)	Latching	Large flow (N.C.)	Latching	Large flow (N.C.)	Large flow (N.C.)	Large flow (N.C.)	Latching
Rc1/8 NPT1/8 G1/8	Supply from one side	12				10		12	
	Supply from both sides					12			
M5 x 0.8	Supply from one side	10				8		10	
	Supply from both sides	12				10		12	

Note) These values are obtained under the standard supply pressure.

Specifications

General Specifications

Operating temperature range	-5 to 50°C (No condensation)
Fluid	Air
Vibration resistance <small>Note 1)</small>	30 m/s ² (Without sensor/switch) 20 m/s ² (With sensor/switch)
Impact resistance <small>Note 2)</small>	150 m/s ² (Without sensor/switch) 100 m/s ² (With sensor/switch)

Note 1) 10 to 500 Hz for 2 hours in each direction of X, Y and Z (During de-energizing)

Note 2) 3 times in each direction of X, Y and Z (During de-energizing)

Supply Valve/Release Valve Common Specifications

Valve construction	3-port direct operated poppet valve
Lubrication	Not required
Manual override <small>Note)</small>	Non-locking push type, Locking type (Tool required)
Enclosure	Dustproof
Rated coil voltage DC	24 V, 12 V
Allowable voltage range	Rated voltage ±10%

Note) Push-locking type only for the latching type

Supply Valve/Release Valve Specifications For details on the VQ100 series, refer to the Web Catalog.

Type	Supply valve			Release valve
	Large flow type (N.C.)		Latching type	Standard
Supply valve/release valve model	ZB1-VQ110U-□	ZB1-VQ120U-□	ZB1-VQ110L-□	ZB1-VQ110-□
Applicable system	Ejector (N.C.)	Pump system (N.C.)	Ejector <small>Note 1)</small>	Ejector (N.C.) Pump system (N.C.)
Maximum operating pressure	0.55 MPa	0.1 MPa	0.55 MPa	0.55 MPa
Minimum operating pressure	0.1 MPa	-0.1 MPa	0.1 MPa	0 MPa
Response time	5 ms or less	5 ms or less	5 ms or less	ON: 3.5 ms OFF: 2 ms
Rated coil voltage	24 VDC	0.7 W (29 mA) <small>Note 2)</small>	0.7 W (29 mA) <small>Note 2)</small>	1 W (42 mA)
Power consumption (Current)	12 VDC	0.7 W (58 mA) <small>Note 2)</small>	0.7 W (58 mA) <small>Note 2)</small>	1 W (83 mA)
Electrical entry	L-type plug connector (With light/surge voltage suppressor) M-type plug connector (With light/surge voltage suppressor) <small>Note 3)</small>			

Note 1) Latching type is applicable only to the ejector nozzle sizes ø0.3 and ø0.4

Note 2) Inrush: 3.1 W (10 ms after energized); Holding: 0.7 W

Note 3) M-type can also be selected when the ejector or the pump system is selected without pressure sensor/vacuum pressure switch.

Ejector Specifications Note 1)

Model	ZB03		ZB04		ZB05	ZB06
Supply valve type	Large flow (N.C.)	Latching	Large flow (N.C.)	Latching	Large flow (N.C.)	Large flow (N.C.)
Nozzle size (mm)	0.3		0.4		0.5	0.6
Supply pressure range <small>Note 2)</small> (MPa)			0.2 to 0.55		0.3 to 0.55	
Standard supply pressure (MPa)	0.35	0.4	0.35	0.45	0.35	0.5
Air consumption (L/min (ANR))	3.5	4	6.5	8.5	10	18
Maximum suction flow (L/min (ANR))	2		3.5		4.5	7
Maximum vacuum pressure (kPa)	-86		-90			

Note 1) These values are representative values, and may vary depending on the atmospheric pressure (weather, height above sea level, etc.).

Note 2) The maximum operating pressure is 0.5 MPa when using the product either with pressure sensor or vacuum pressure switch.

Suction Filter Specifications

Nominal filtration rating	30 μm
Filtration area	130 mm ²

Refer to Vacuum Equipment Model Selection from pages 11 to 32 for the ejector model selection.

Weight

Single Unit

Single unit model	Weight (g)
ZB□1/2□-K1□ (Single unit, without sensor)	46
ZB□3□-K1□ (One station for manifold, without sensor)	40

Pressure Sensor/Vacuum Pressure Switch

Pressure sensor/vacuum pressure switch model	Weight (g)
ZB1-PS□-A (Except pressure sensor, cable portion)	5
ZB1-ZS□□-A (Except vacuum pressure switch, lead wire assembly with connector)	14

Manifold Base

	1 sta.	2 sta.	3 sta.	4 sta.	5 sta.	6 sta.	7 sta.	8 sta.	9 sta.	10 sta.	11 sta.	12 sta.
Weight (g)	16	22	28	34	41	47	53	60	66	72	79	85

Calculation of weight for the manifold type

(Single unit weight x Number of stations) + (Pressure sensor/vacuum pressure switch weight x Number of stations) + Manifold base

Example) 5-station manifold with pressure sensors

$$40 \text{ g} \times 5 \text{ pcs.} + 5 \text{ g} \times 5 \text{ pcs.} + 41 \text{ g} = \boxed{266 \text{ g}}$$

Ejector Exhaust Characteristics/Flow Rate Characteristics

Nozzle Size $\phi 0.3$ Supply Valve, Large Flow Type (N.C.)/ZB03□□-K1

Exhaust Characteristics

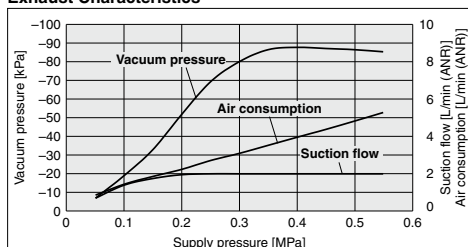

Flow Rate Characteristics

(Supply pressure: 0.35 MPa)

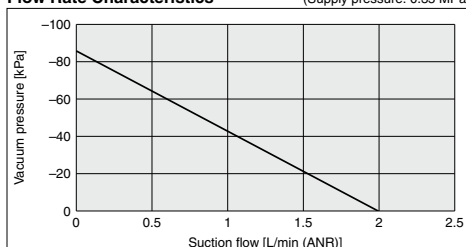

Nozzle Size $\phi 0.4$ Supply Valve, Large Flow Type (N.C.)/ZB04□□-K1

Exhaust Characteristics

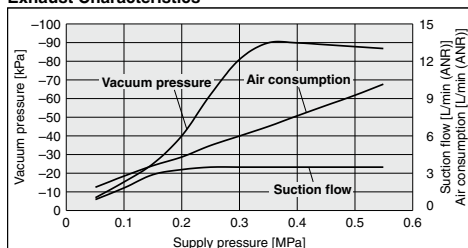

Flow Rate Characteristics

(Supply pressure: 0.35 MPa)

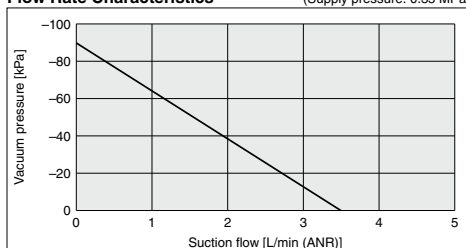

Nozzle Size $\phi 0.5$ Supply Valve, Large Flow Type (N.C.)/ZB05□□-K1

Exhaust Characteristics

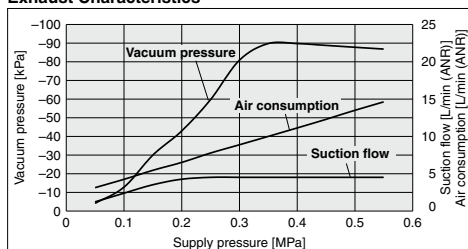

Flow Rate Characteristics

(Supply pressure: 0.35 MPa)

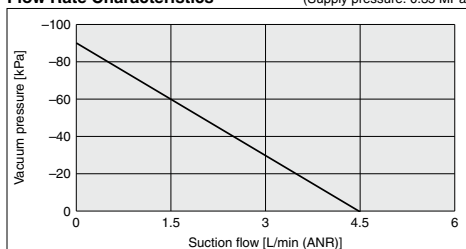

Nozzle Size $\phi 0.6$ Supply Valve, Large Flow Type (N.C.)/ZB06□□-K1

Exhaust Characteristics

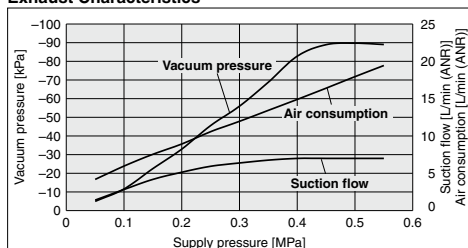

Flow Rate Characteristics

(Supply pressure: 0.5 MPa)

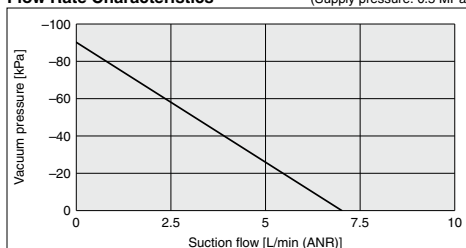

Nozzle Size $\phi 0.3$ Supply Valve, Latching Type/ZB03□□-Q₁

Exhaust Characteristics

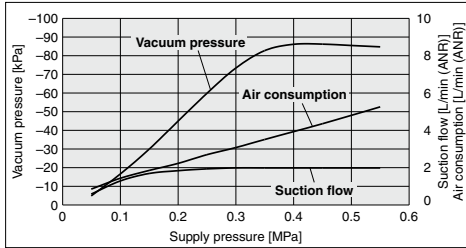

Flow Rate Characteristics

(Supply pressure: 0.4 MPa)

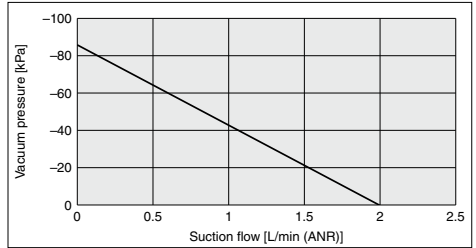

Nozzle Size $\phi 0.4$ Supply Valve, Latching Type/ZB04□□-Q₁

Exhaust Characteristics

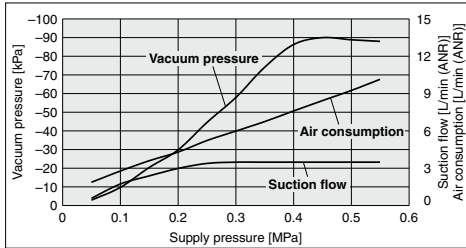

Flow Rate Characteristics

(Supply pressure: 0.45 MPa)

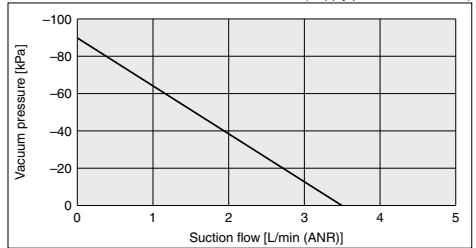

Vacuum Pump System Flow Rate Characteristics/ZB00

The graph shows the suction flow rate characteristics of the vacuum pump system at different vacuum pressures.

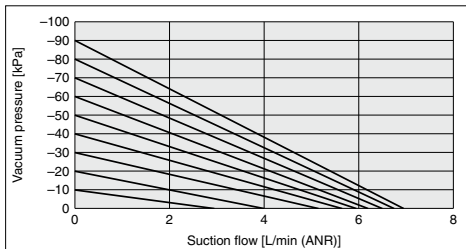

The actual suction flow at the point of suction varies depending on the vacuum pump's piping conditions. (For above graph, vacuum (V) port is $\phi 4 \times 50$ mm.)

Flow rate characteristics: Cv : 0.025

Release Flow Rate Characteristics (Ejector/Pump System)

The graph shows the flow rate characteristics with various supply pressures when the vacuum break flow adjustment needle is opened from the fully close state.

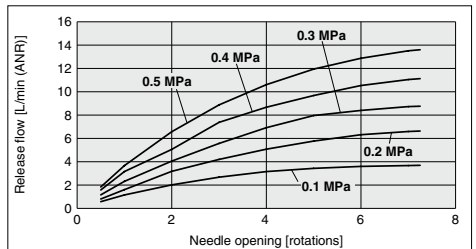

Note) The flow rate characteristics shown in this graph are representative values, and the flow at the absorption part may vary depending on the piping conditions to the vacuum (V) port, etc.

Flow rate characteristics: Cv : 0.011 (Needle full open)

How to Read Flow Rate Characteristics Graph

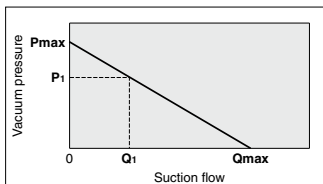

Flow rate characteristics are expressed in ejector vacuum pressure and suction flow. If suction flow changes, the vacuum pressure will also be changed. Normally this relationship is expressed in ejector standard operating pressure use. In graph, **Pmax** is max. vacuum pressure and **Qmax** is maximum suction flow. The values are specified according to catalog use. Changes in vacuum pressure are expressed in the below order.

1. When ejector suction port is covered and made airtight, suction flow becomes zero and vacuum pressure is at maximum value (**Pmax**).
2. When suction port is opened gradually, air can flow through, (air leakage), suction flow increases, but vacuum pressure decreases. (condition **P1** and **Q1**)
3. When suction port is opened further and fully opened, suction flow moves to maximum value (**Qmax**), but vacuum pressure is near zero (atmospheric pressure).

As described above, the vacuum pressure changes when the suction flow changes. In other words, when there is no leakage from the vacuum (V) port, the vacuum pressure can reach its maximum, but as the amount of leakage increases, the vacuum pressure decreases. When the amount of leakage and the max. suction flow become equal, the vacuum pressure becomes almost zero.

In the case when ventilative or leaky work should be adsorbed, please note that vacuum pressure will not rise.

ZB Series

Pressure Sensor/Vacuum Pressure Switch Specifications

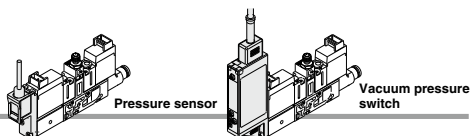

Pressure Sensor/ZB1-PS□-A (Refer to the PSE series in the Web Catalog and Operation Manual for details.)

Model (Refer to the standard model number for the sensor unit on page 692.)	ZB1-PS1-A (PSE541)	ZB1-PS3-A (PSE543)
Rated pressure range	0 to -101 kPa	-100 to 100 kPa
Proof pressure		500 kPa
Output voltage		1 to 5 VDC
Output impedance		Approx. 1 kΩ
Power supply voltage	10 to 24 VDC±10%, Ripple (p-p) 10% or less	
Current consumption	15 mA or less	
Accuracy	±2% F.S. (Ambient temperature: 25°C)	
Linearity	±0.4% F.S. or less	
Repeat accuracy	±0.2% F.S. or less	
Effect of power supply voltage	±0.8% F.S. or less	
Temperature characteristics	±2% F.S. or less (Ambient temperature: based on 25°C)	
Material	Case	Resin
	Pressure sensing section	Sensor pressure receiving area: Silicon, O-ring: HNBR Oil-resistant vinyl cabtire cable
Lead wire	2.7 x 3.2 mm (elliptic), Cross section: 0.15 mm ² , 3 cores, 3 m, Insulator O.D.: 0.9 mm	

Vacuum Pressure Switch/ZB1-ZS□□□□-A (Refer to the ZSE/ISE10 series in the Web Catalog and Operation Manual for details.)

Model (Refer to the standard model number for the switch unit on page 692.)	ZB1-ZSE□□□□-A (ZSE10)	ZB1-ZSF□□□□-A (ZSE10F)
Rated pressure range	0 to -101 kPa	-100 to 100 kPa
Set pressure range/Pressure display range	10 to -105 kPa	-105 to 105 kPa
Proof pressure		500 kPa
Minimum unit setting		0.1 kPa
Power supply voltage	12 to 24 VDC±10%, Ripple (p-p) 10% or less (with power supply polarity protection)	
Current consumption	40 mA or less	
Switch output	NPN or PNP open collector 2 outputs (Select)	
	Maximum load current	80 mA
	Maximum applied voltage	28 V (with NPN output)
	Residual voltage	2 V or less (with load current of 80 mA)
	Response time	2.5 ms or less (Response time selections with anti-chattering function: 20, 100, 500, 1000, 2000 ms)
	Short circuit protection	Yes
Repeat accuracy	±0.2% F.S. ±1 digit	
Hysteresis	Hysteresis mode	Variable (0 or above) ^{Note 1)}
	Window comparator mode	
Display	3 1/2 digit, 7-segment LED, 1-color display (Red)	
Display accuracy	±2% F.S. ±1 digit (Ambient temperature of 25 ±3°C)	
Indicator light	Lights up when output is turned ON. OUT1: Green, OUT2: Red	
Environmental resistance	Enclosure	IP40
	Operating humidity range	Operating/Stored: 35 to 85% RH (No condensation)
	Withstand voltage	1000 VAC for 1 minute between live parts and enclosure
Temperature characteristics	Insulation resistance	50 MΩ or more between live parts and enclosure (at 500 VDC mega)
		±2% F.S. (at 25°C in an operating temperature range of -5 and 50°C)
Lead wire	Oil-resistant vinyl cabtire cable Cross section: 0.15 mm ² (AWG26), 5 cores, 2 m, Insulator O.D.: 1.0 mm	



Note 1) If the applied voltage fluctuates around the set value, the hysteresis must be set to a value more than the fluctuating width, otherwise chattering will occur.
Note 2) Refer to "General Specifications" on page 687 for the specifications not shown in the table.

IO-Link Compatible Vacuum Pressure Switch/ZB1-ZS□□□-A

(For details, refer to the ZB1-ZS□□□-A operation manual on the SMC website.)

Model	ZB1-ZSEL□□-A	ZB1-ZSFL□□-A	
Rated pressure range	0 to -101 kPa	-100 to 100 kPa	
Set pressure range	10 to -105 kPa	-105 to 105 kPa	
Proof pressure	500 kPa		
Smallest settable increment	0.1 kPa		
Power supply voltage	24 VDC ±10%, Ripple (p-p) 10% or less (with power supply polarity protection)		
Current consumption	40 mA or less		
Switch output	Output type	PNP open collector OUT1, OUT2: For valve control	
	Residual voltage	2 V or less (with load current of 80 mA)	
	Short circuit protection	Yes	
Repeatability	±0.2% F.S. ±1 digit		
Hysteresis	Variable (0.1 or above)		
Display	3 1/2 digit, 7-segment LED, 1-color display (Red)		
Display accuracy	±2% F.S. ±1 digit (Ambient temperature of 25 ±3°C)		
Indicator light	Lights up when solenoid valve output is turned ON. Release valve output (OUT1): Green, Supply valve output (OUT2): Red		
Digital filter	Variable from 0 to 10 s (0.01 s increments)		
Environmental resistance	Enclosure	IP40	
	Withstand voltage	1000 VAC for 1 min between terminals and housing	
	Insulation resistance	50 MΩ or more (500 VDC measured via megohmmeter) between terminals and housing	
	Operating temperature range	Operating: -5 to 50°C, Stored: -10 to 60°C (No condensation or freezing)	
Temperature characteristics	Operating humidity range	Operating/Stored: 35 to 85% RH (No condensation)	
	Temperature characteristics	±2% F.S. (25°C standard)	
Lead wire	Cable 3 cores, ø3.4, 300 mm Valve connector lead wire Insulator O.D.: 1.5 mm, 100 mm		

Description (Vacuum Pressure Switch)

Output (OUT1) display (Green)	Lights up when OUT1 is turned ON.
Output (OUT2) display (Red)	Lights up when OUT2 is turned ON.
LED display	Displays the current pressure, set mode and error code.
 button (UP)	Selects the mode or increases the ON/OFF set-value. Use for switching to the peak display mode.
 button (DOWN)	Selects the mode or decreases the ON/OFF set-value. Use for switching to the bottom display mode.
 button (SET)	Use for changing the mode or setting the set-value.

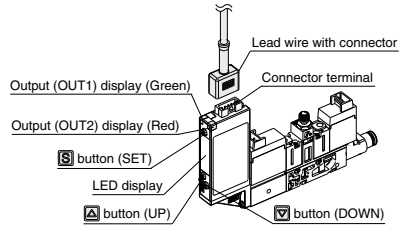

Internal Circuits and Wiring Examples

■ Pressure Sensor

ZB1-PS□-A

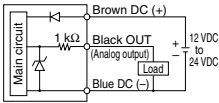

Voltage output type: 1 to 5 V
Output impedance: Approx. 1 kΩ

■ Vacuum Pressure Switch

ZB1-ZS□A□□-A
NPN (2 outputs)

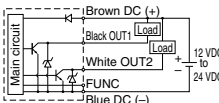

Max. 28 V, 80 mA
Residual voltage: 2 V or less

ZB1-ZS□B□□-A
PNP (2 outputs)

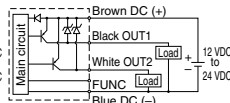

Max. 80 mA
Residual voltage: 2 V or less

* The FUNC terminal is connected when using the copy function. (Refer to the Operation Manual.)

■ IO-Link Compatible Vacuum Pressure Switch

ZB1-ZS□□□□-A

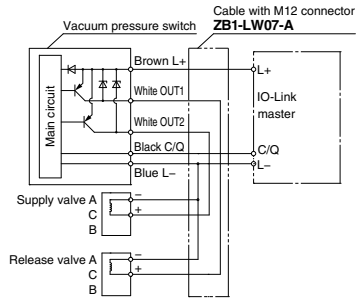

IO-Link: Process Data

Relationship between the process data and pressure value

ZB1-ZSEL□□-A (For 0 to -101 kPa)

Measured pressure value (PD)

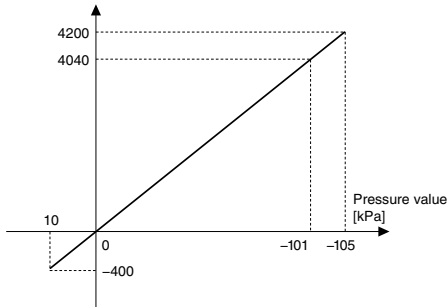

ZB1-ZSFL□□-A (For -100 to 100 kPa)

Measured pressure value (PD)

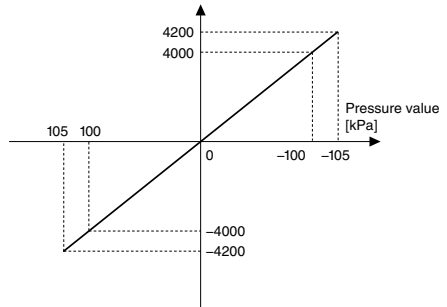

Construction

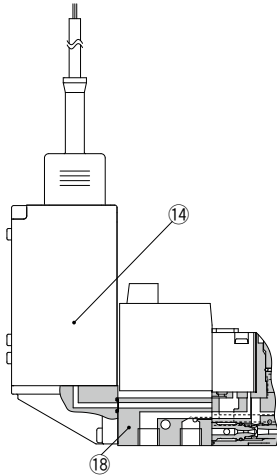

Single Unit/Vacuum Pressure Switch

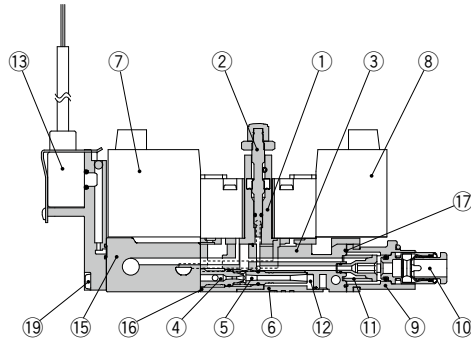

Manifold/Pressure Sensor

Component Parts

No.	Description	Material	Note
1	Valve body assembly	Resin/HNBR	White
2	Needle assembly	Resin/Brass/NBR	—
3	Body	Resin	White
4	Nozzle	Aluminum	Vacuum pump system: Spacer
5	Diffuser	Aluminum	Vacuum pump system: None
6	Silencer cover	Resin	White

Replacement Parts

No.	Description	Model (Refer to page 692.)	Note
7	Supply valve	ZB1-VQ110U-□□□ ZB1-VQ110L-□□ ZB1-VQ120U-□□□□	Refer to Table 1 on page 692 for applicable part number.
8	Release valve	ZB1-VQ110-□□□□	
9	V-port assembly	ZB1-VPN3-□-A	
10	One-touch fitting	KJ□□-C1	It is required when replacing the fitting only.
11	Filter element	ZB1-FE3-A	Nominal filtration rating: 30 μm, 10 pcs. per set
12	Sound absorbing material	ZB1-SE1-A	10 pcs. per set
13	Pressure sensor assembly	ZB1-PS□-A	
14	Vacuum pressure switch assembly	ZB1-ZS□□□□-A	
15	Manifold base assembly	ZZB□-□□□	Refer to "Manifold" in "How to Order the Product" on page 686 for change in the number of stations.
16	Gasket	ZB1-GK1-A	10 pcs. per set
17	Filter case gasket	ZB1-FG1-A	10 pcs. per set
18	Body assembly for single unit	ZB1-SB□-A	Without pressure sensor/switch, 2 mounting screws (M2 x 26) are included.
		ZB1-SBS□-A	With pressure sensor/switch, 2 mounting screws (M2 x 30) are included.
19	Mounting screw	ZB1-SR1-1-A	Without pressure sensor/switch, 10 pcs. per set
		ZB1-SR1-2-A	With pressure sensor/switch, 10 pcs. per set

How to Replace the Filter

When adsorption performance decreases or when there is delay in response time due to clogging of the filter, stop the operation and replace the filter with a new one.

- 1) Hold the V-port assembly with your fingers, turn it 45 degrees in the counterclockwise direction and pull it out. For the straight type fitting, it can be removed with a hexagon wrench (width across flats: 2) by inserting it until it touches the end and turning it 45 degrees in the counterclockwise direction. (When using a wrench, do not turn it more than 45 degrees by force as this will damage the hexagon hole which is made of resin.)
- 2) Remove the filter element from the removed filter case, and mount a new filter element into the case.
- 3) Confirm that the filter case gasket is not displaced and that it has no foreign matter stuck to it.
- 4) Insert the tab of the V-port assembly along the groove, and rotate it approx. 45 degrees in the clockwise direction while pressing it gently until it stops. (Mount the filter case in the direction specified in the figure. If it is mounted with the tab downwards, it will interfere with the floor when the unit is installed on the floor.)

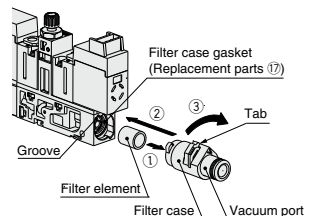

How to Order Replacement Parts

⑦ Supply valve/⑧ Release valve

Table 1 Combination of the supply valve and the release valve

* The applicable supply valve specification varies depending on the nozzle size of the ejector.
 * The symbols in the table correspond to the supply valves/release valves stated on the right.

Symbol	Supply valve/release valve specifications		Ejector				Pump system					
	Supply valve	Release valve	ZB03		ZB04		ZB05		ZB06		ZB00	
K1	N.C.	N.C.	(1)	(4)	(1)	(4)	(1)	(4)	(1)	(4)	(3)	(4)
J1	N.C.	None	(1)		(1)		(1)		(1)		(3)	
Q1	Latch	N.C.	(2)	(4)	(2)	(4)						
Q2	Latch	None	(2)		(2)							

Table 2 Connector assembly

AXT661 - [] - []

Applicable valve

14A	(1), (3), (4) (N.C.)
13A	(2) (Latching)

Lead wire length (mm)

Nil	300
6	600
10	1000
20	2000
30	3000

Table 3 Supply valve/release valve accessories

Supply valve/release valve model	Accessories
ZB1-VQ110U -□□	Mounting screw (M1.7 x 15) 2 pcs.
ZB1-VQ110U -□□ B	Mounting screw (M1.7 x 22) 2 pcs.
ZB1-VQ110L -□□	Mounting screw (M1.7 x 22) 2 pcs.
ZB1-VQ120U -□□	Mounting screw (M1.7 x 15) 2 pcs.
ZB1-VQ120U -□□ B	Mounting screw (M1.7 x 22) 2 pcs.
ZB1-VQ110 -□□	Mounting screw (M1.7 x 15) 2 pcs.
ZB1-VQ110 -□□ B	Mounting screw (M1.7 x 22) 2 pcs.

⑨ V-port assembly

ZB1 - VPN3 - [C2] - A

One-touch fitting

C2	Straight ø2 one-touch fitting	Metric size
C4	Straight ø4 one-touch fitting	Metric size
N1	Straight ø1/8" one-touch fitting	Inch size
N3	Straight ø5/32" one-touch fitting	Inch size
L2	Elbow ø2 one-touch fitting	Metric size
L4	Elbow ø4 one-touch fitting	Metric size
LN1	Elbow ø1/8" one-touch fitting	Inch size
LN3	Elbow ø5/32" one-touch fitting	Inch size

⑩ One-touch fitting (Purchasing order is available in units of 10 pieces.)

KJ [H] [04] - C1

Body type

H	Straight
L	Elbow

Port size

02	ø2 one-touch fitting	Metric size
04	ø4 one-touch fitting	Metric size
01	ø1/8" one-touch fitting	Inch size
03	ø5/32" one-touch fitting	Inch size

* Body type: Only for the combination of the elbow type body and the ø4 one-touch fitting, add the suffix "N" to the part number.

KJL04-C1-N

⑪ Filter element (10 pcs. in 1 set)

ZB1 - FE3 - A

* Nominal filtration rating using suction filter: 30 µm

⑫ Sound absorbing material (10 pcs. in 1 set)

ZB1 - SE1 - A

■ Supply valve/release valve model

- (1) ZB1-VQ110U - [] [] []
- (2) ZB1-VQ110L - [] [] []
- (3) ZB1-VQ120U - [] [] []
- (4) ZB1-VQ110 - [] [] []

Rated voltage

5	24 VDC
6	12 VDC

Connector entry direction ^{Note 1)}

L	L-type plug connector, with lead wire
LO	L-type plug connector, without connector
M	M-type plug connector, with lead wire ^{Note 2)}
MO	M-type plug connector, without connector ^{Note 2)}

Note 1) All with light and surge voltage suppressor.
 Lead wire length is 300 mm for the models with lead wire.
 For other lead wire length, select a model without connector and include the connector assembly part number.

Note 2) M-type plug connector is not available with the model with pressure sensor.

Manual override ^{Note 3)}

Nil	Non-locking push type
B	Locking type (Tool required), Semi-standard

Note 3) Only the push-locking type (no symbol) is available for the latching type.
 Note 4) Refer to **Table 3** for the accessories.

⑬ Pressure sensor assembly

ZB1 - PS [1] - A

Pressure sensor specifications

1	0 to -101 kPa, output: 1 to 5 V, accuracy: ±2% F.S. or less
3	-100 to 100 kPa, output: 1 to 5 V, accuracy: ±2% F.S. or less

* Lead wire length: 3 m

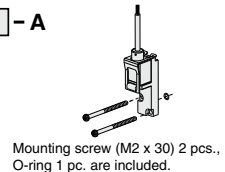

⑭ Vacuum pressure switch assembly

ZB1 - ZS [A] [M] [G] - A

Rated pressure range

E	0.0 to -101.0 kPa
F	-100.0 to 100 kPa

Output specifications

A	NPN open collector 2 outputs
B	PNP open collector 2 outputs
L	IO-Link

Lead wire with connector

Nil	Without lead wire with connector
G	With lead wire with connector (Lead wire length: 2 m)
H	Lead wire with connector for IO-Link compatible vacuum pressure switch (With M12 connector, Length: 300 mm)

Unit specifications

Nil	With unit switching function ^{Note 1)}
M	SI unit only ^{Note 2)}

P ^{Note 3)} With unit switching function (Initial value psi) ^{Note 1)}

Note 1) The unit switching function is not available in Japan due to a new measurement law.

Note 2) Fixed unit: kPa

Note 3) This option cannot be selected if "L" is selected for the output specification.

Mounting screw (M2 x 30) 2 pcs.,
 O-ring 1 pc. are included.

* If only the lead wire with connector is required, order using the following part number.

Part number of the lead wire with connector: **ZS-39-5G**

Part number of the lead wire with connector for IO-Link compatible vacuum pressure switch: **ZB1-LW07-A**

Dimensions: Single Unit

ZB□□¹⁰₁₁²⁰-K15LO□-□^E□□-□²¹

Ejector/Vacuum pump system
Silencer exhaust,
With supply valve/release valve,
With IO-Link compatible vacuum
pressure switch

(mm)		
Port type	A	B
C2	4.1	103.6
C4	7.5	107
N1	7.4	106.9
N3	7.5	107
L2	8.4	107.9
L4	8.3	107.8
LN1	8.3	107.8
LN3	8.3	107.8

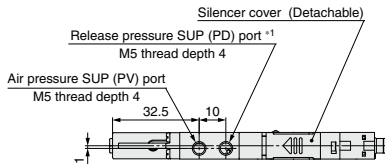
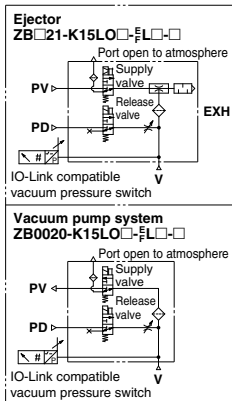
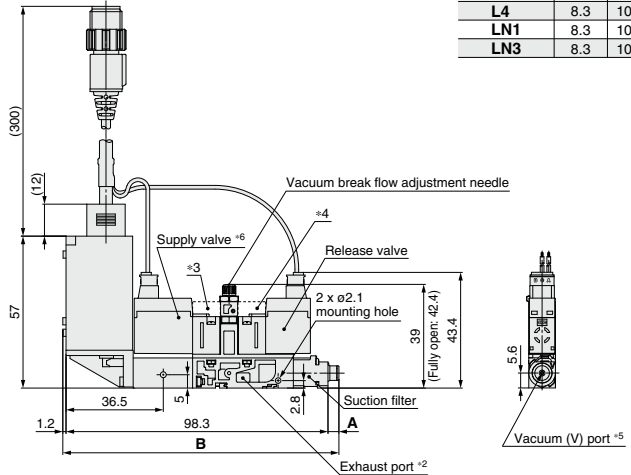
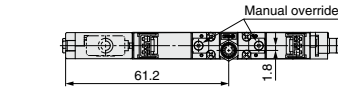
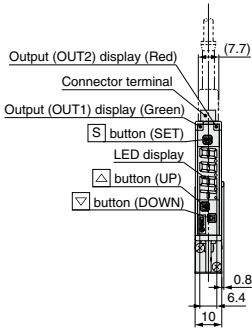

- *1 Without port for PV=PD specification
- *2 When this product is used as an ejector, do not block the exhaust port when mounting. When the product is mounted so that the exhaust port side will be against a wall, use a spacer to secure a clearance of at least 1 mm. (Refer to page 700 for details.)
No exhaust port for pump system
- *3 The dotted line shows the configuration of the latching type and the manual lock type.
- *4 The dotted line shows the manual lock type.
- *5 Refer to page 697 for the dimensions for the various vacuum (V) ports.
- *6 For the unit with vacuum pressure switch, M-type plug connector cannot be selected.

ZB Series

Dimensions: Manifold

ZZB□-S $\frac{0}{M5}$ □ **M5**

* **ZB□31-0-K15LO□-F** L□-□

**Ejector/Vacuum pump system
Silencer exhaust,
With supply valve/release valve,
With IO-Link compatible
vacuum pressure switch,
PV, PD individual port (PV ≠ PD)**

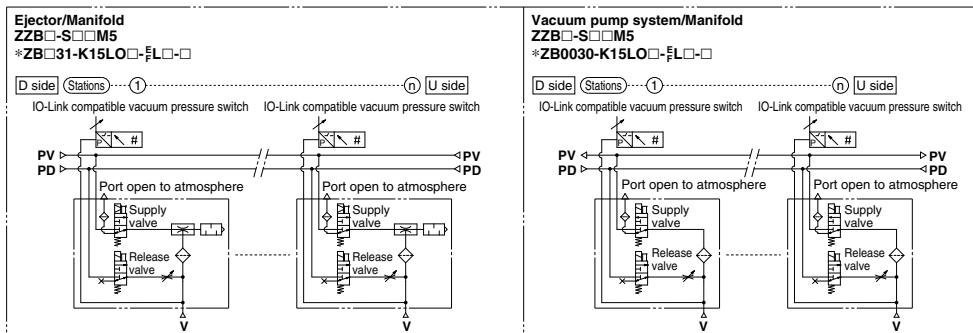
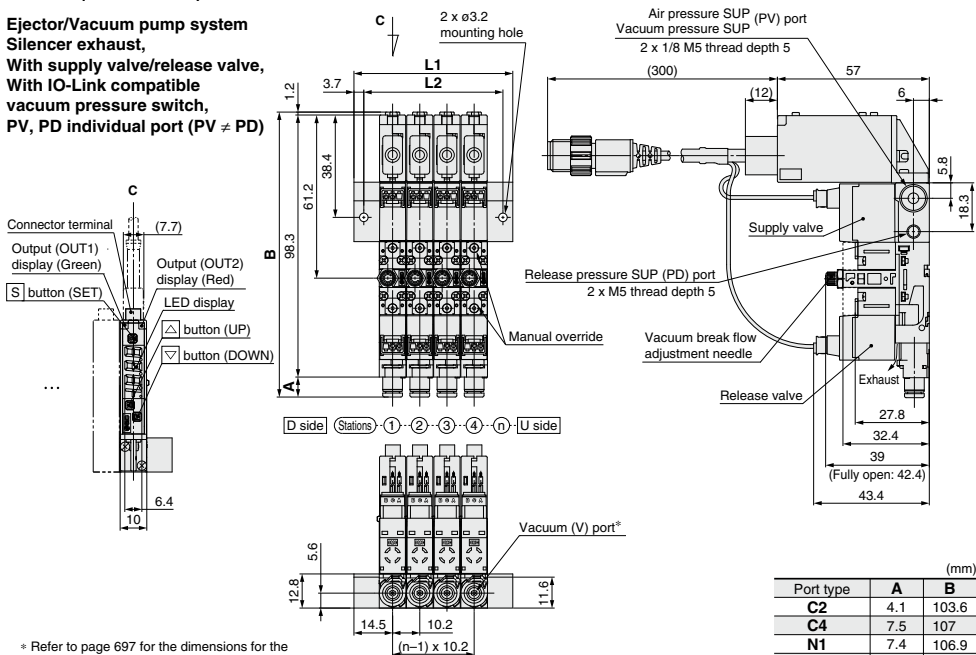

L	n	1	2	3	4	5	6	7	8	9	10	11	12
L1		29	39.2	49.4	59.6	69.8	80	90.2	100.4	110.6	120.8	131	141.2
L2		21.6	31.8	42	52.2	62.4	72.6	82.8	93	103.2	113.4	123.6	133.8

ZB Series Accessories

Communication Cable

For IO-Link

Connection examples

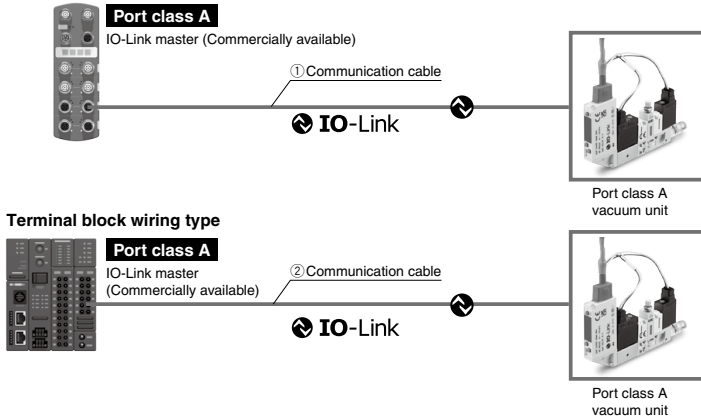

① Communication cable

EX9-AC 005 -SSPS (With connector on both sides (Socket/Plug))

● Cable length (L)

005	500 mm
010	1000 mm
020	2000 mm
030	3000 mm
050	5000 mm
100	10000 mm

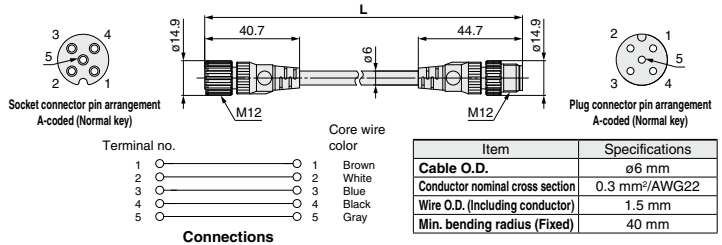

EX9-AC 005 -SAPA (With connector on both sides (Socket/Plug))

● Cable length (L)

005	500 mm
010	1000 mm
020	2000 mm
030	3000 mm
050	5000 mm
100	10000 mm

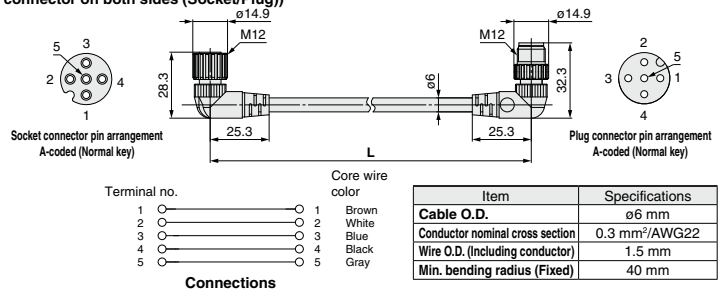

Communication Cable

For IO-Link

② Communication cable

EX500-AP 050 - S

Cable length (L)

010	1000 mm
050	5000 mm

Connector specification

S	Straight
A	Angled

Straight connector type

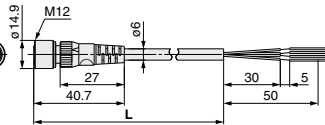
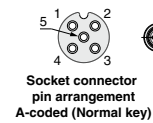

Item	Specifications
Cable O.D.	ø6 mm
Conductor nominal cross section	0.3 mm ² /AWG22
Wire O.D. (Including insulator)	1.5 mm
Min. bending radius (Fixed)	40 mm

Angled connector type

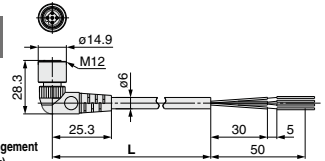
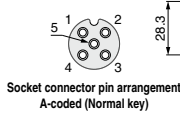

Item	Specifications
Cable O.D.	ø6 mm
Conductor nominal cross section	0.3 mm ² /AWG22
Wire O.D. (Including insulator)	1.5 mm
Min. bending radius (Fixed)	40 mm

Terminal no.



Core wire color



Connections

Dimensions: Single Unit

ZB \square $\frac{10}{20}$ - $\frac{K1}{Q1}$ \square L(O) \square M(O) \square - \square

Ejector/Vacuum pump system
Silencer exhaust, With supply valve/release valve,
Without sensor/switch

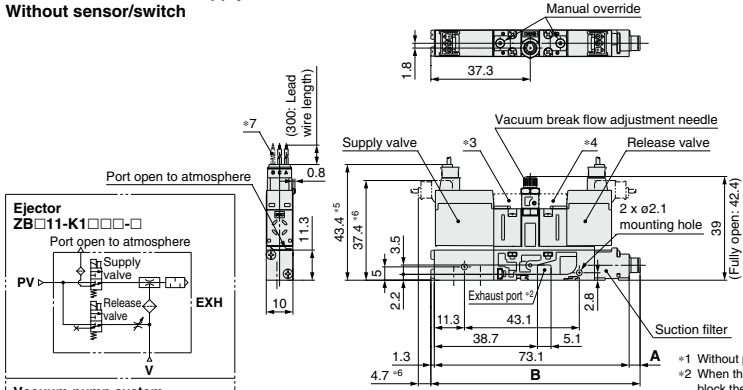

(mm)		
Port type	A	B
C2	4.1	78.5
C4	7.5	81.9
N1	7.4	81.8
N3	7.5	81.9
L2	8.4	82.8
L4	8.3	82.7
LN1	8.3	82.7
LN3	8.3	82.7

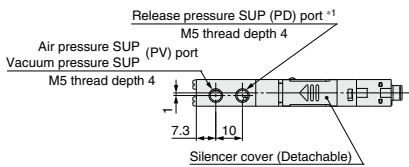
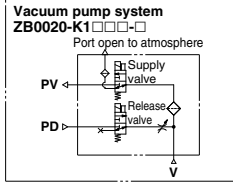
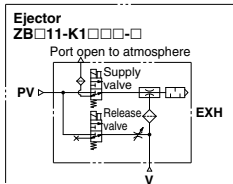

- *1 Without port for PV=PD specification
- *2 When this product is used as an ejector, do not block the exhaust port when mounting. When the product is mounted so that the exhaust port side will be against a wall, use a spacer to secure a clearance of at least 1 mm. (Refer to page 700 for details.)
No exhaust port for pump system
- *3 The dotted line shows the configuration of the latching type and the manual lock type.
- *4 The dotted line shows the manual lock type.
- *5 For L-type plug connector
- *6 For M-type plug connector
- *7 It has 3 lead wires for the latching type.
- *8 Refer to page 697 for the dimensions for the various vacuum (V) ports.

ZB \square $\frac{10}{11}$ - $\frac{J1}{Q2}$ \square L(O) \square M(O) \square - \square

Ejector/Vacuum pump system
Silencer exhaust, With supply valve only,
Without sensor/switch

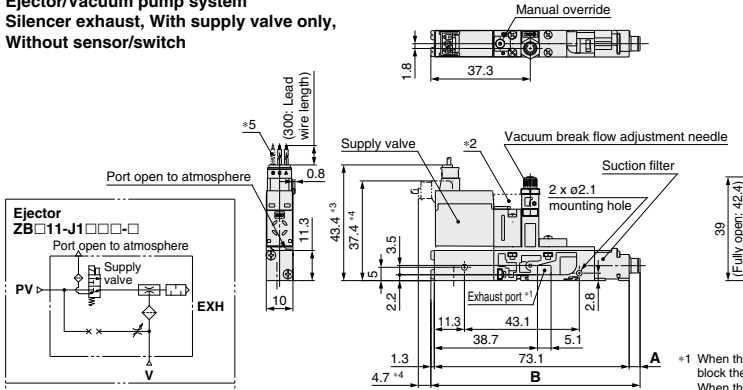

(mm)		
Port type	A	B
C2	4.1	78.5
C4	7.5	81.9
N1	7.4	81.8
N3	7.5	81.9
L2	8.4	82.8
L4	8.3	82.7
LN1	8.3	82.7
LN3	8.3	82.7

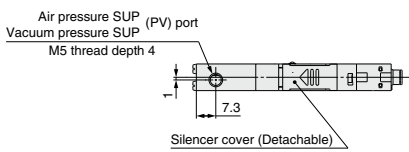
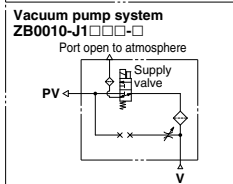
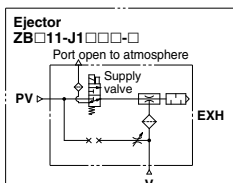

- *1 When this product is used as an ejector, do not block the exhaust port when mounting. When the product is mounted so that the exhaust port side will be against a wall, use a spacer to secure a clearance of at least 1 mm. (Refer to page 700 for details.)
No exhaust port for pump system
- *2 The dotted line shows the configuration of the latching type and the manual lock type.
- *3 For L-type plug connector
- *4 For M-type plug connector
- *5 It has 3 lead wires for the latching type.
- *6 Refer to page 697 for the dimensions for the various vacuum (V) ports.

ZB Series

Dimensions: Single Unit

ZB□¹⁰/₂₀□^{K1}/₂₁□□L(O)□-P₃-□

Ejector/Vacuum pump system
Silencer exhaust,
With supply valve/release valve,
With pressure sensor

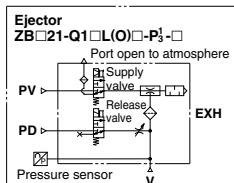

Vacuum pump system
ZB0020-K1□□L(O)□-P₃-□

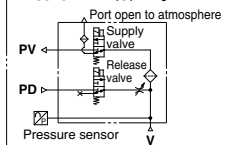

ZB□¹⁰/₂₀□^{K1}/₂₁□□L(O)□-F□□□□

Ejector/Vacuum pump system
Silencer exhaust,
With supply valve/release valve,
With vacuum pressure switch

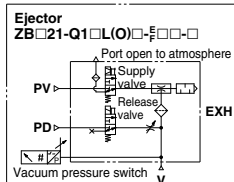
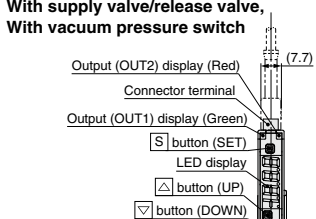

Vacuum pump system
ZB0020-K1□□L(O)□-F□□□□

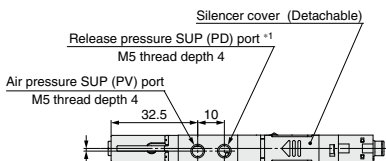
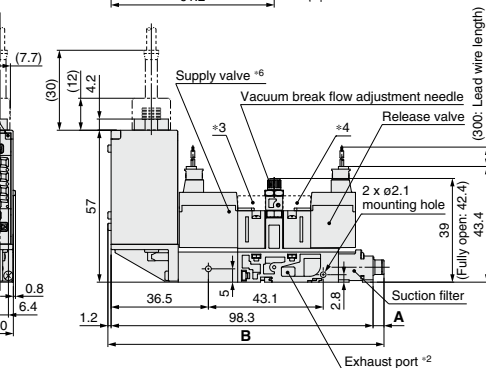
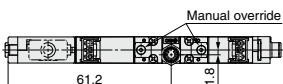
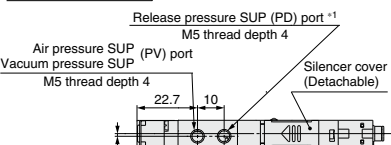
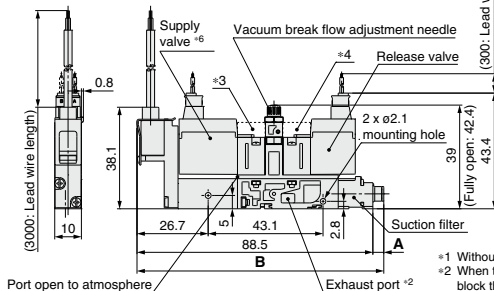
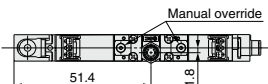
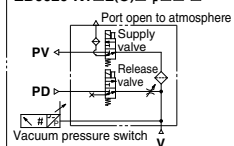

(mm)		
Port type	A	B
C2	4.1	92.6
C4	7.5	96
N1	7.4	95.9
N3	7.5	96
L2	8.4	96.9
L4	8.3	96.8
LN1	8.3	96.8
LN3	8.3	96.8

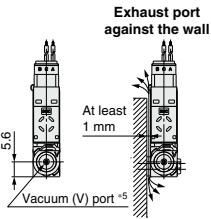

- *1 Without port for PV=PD specification
- *2 When this product is used as an ejector, do not block the exhaust port when mounting. When the product is mounted so that the exhaust port side will be against a wall, use a spacer to secure a clearance of at least 1 mm. (Refer to page 700 for details.)
- No exhaust port for pump system
- *3 The dotted line shows the configuration of the latching type and the manual lock type.
- *4 The dotted line shows the manual lock type.
- *5 Refer to page 697 for the dimensions for the various vacuum (V) ports.
- *6 For the unit with pressure sensor, M-type plug connector cannot be selected.

(mm)		
Port type	A	B
C2	4.1	103.6
C4	7.5	107
N1	7.4	106.9
N3	7.5	107
L2	8.4	107.9
L4	8.3	107.8
LN1	8.3	107.8
LN3	8.3	107.8

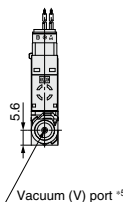

- *1 Without port for PV=PD specification
- *2 When this product is used as an ejector, do not block the exhaust port when mounting. When the product is mounted so that the exhaust port side will be against a wall, use a spacer to secure a clearance of at least 1 mm. (Refer to page 700 for details.)
- No exhaust port for pump system
- *3 The dotted line shows the configuration of the latching type and the manual lock type.
- *4 The dotted line shows the manual lock type.
- *5 Refer to page 697 for the dimensions for the various vacuum (V) ports.
- *6 For the unit with vacuum pressure switch, M-type plug connector cannot be selected.

Dimensions: Manifold

ZB□-01□
M5

*ZB□31-K1□□L(O)□□□

Ejector

**Silencer exhaust,
With supply valve/release valve,
Without sensor/switch,
PV, PD common port (PV = PD)**

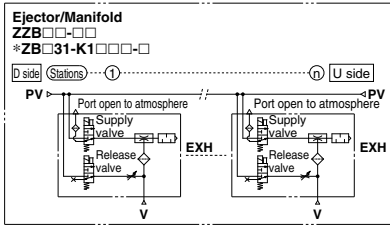
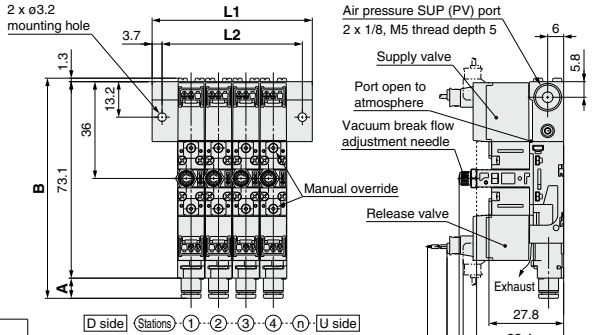

	n	1	2	3	4	5	6	7	8	9	10	11	12
L1	29	39.2	49.4	59.6	69.8	80	90.2	100.4	110.6	120.8	131	141.2	
L2	21.6	31.8	42	52.2	62.4	72.6	82.8	93	103.2	113.4	123.6	133.8	

D side (Stations) ① ② ③ ④ (n) U side

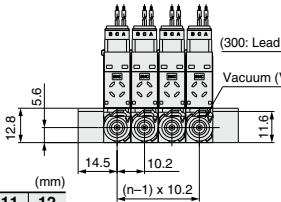

Port type	A	B
C2	4.1	78.5
C4	7.5	81.9
N1	7.4	81.8
N3	7.5	81.9
L2	8.4	82.8
L4	8.3	82.7
LN1	8.3	82.7
LN3	8.3	82.7

* Refer to page 697 for the dimensions for the various vacuum (V) ports.

ZB□-S01□ M5

*ZB□31□-K1□□L(O)□□-P3□

Ejector/Vacuum pump system

**Silencer exhaust, With supply valve/release valve,
With pressure sensor, PV, PD individual port (PV ≠ PD)**

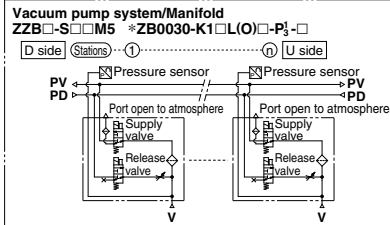
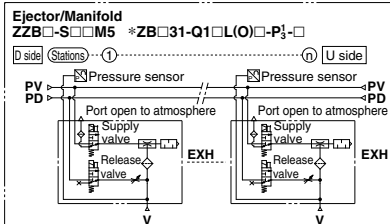
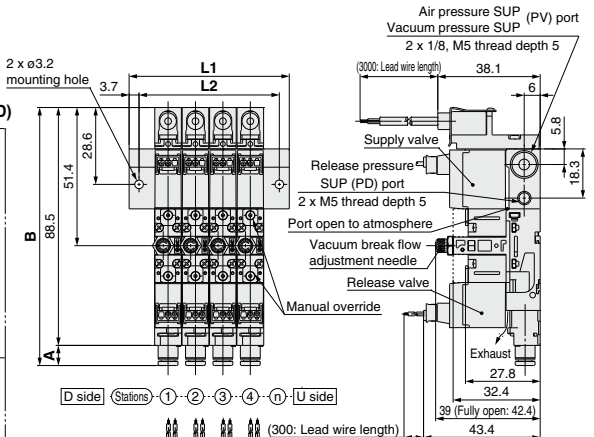

	n	1	2	3	4	5	6	7	8	9	10	11	12
L1	29	39.2	49.4	59.6	69.8	80	90.2	100.4	110.6	120.8	131	141.2	
L2	21.6	31.8	42	52.2	62.4	72.6	82.8	93	103.2	113.4	123.6	133.8	

D side (Stations) ① ② ③ ④ (n) U side

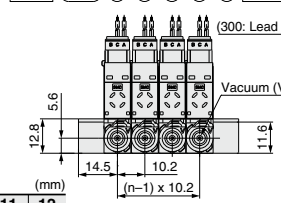

Port type	A	B
C2	4.1	92.6
C4	7.5	96
N1	7.4	95.9
N3	7.5	96
L2	8.4	96.9
L4	8.3	96.8
LN1	8.3	96.8
LN3	8.3	96.8

* Refer to page 697 for the dimensions for the various vacuum (V) ports.

Dimensions: Manifold

ZZB□-S□M5

*ZB□31-Q1□L(O)□-F□□-□

Ejector/Vacuum pump system
Silencer exhaust,

With supply valve/release valve,

With vacuum pressure switch,
PV, PD individual port (PV ≠ PD)

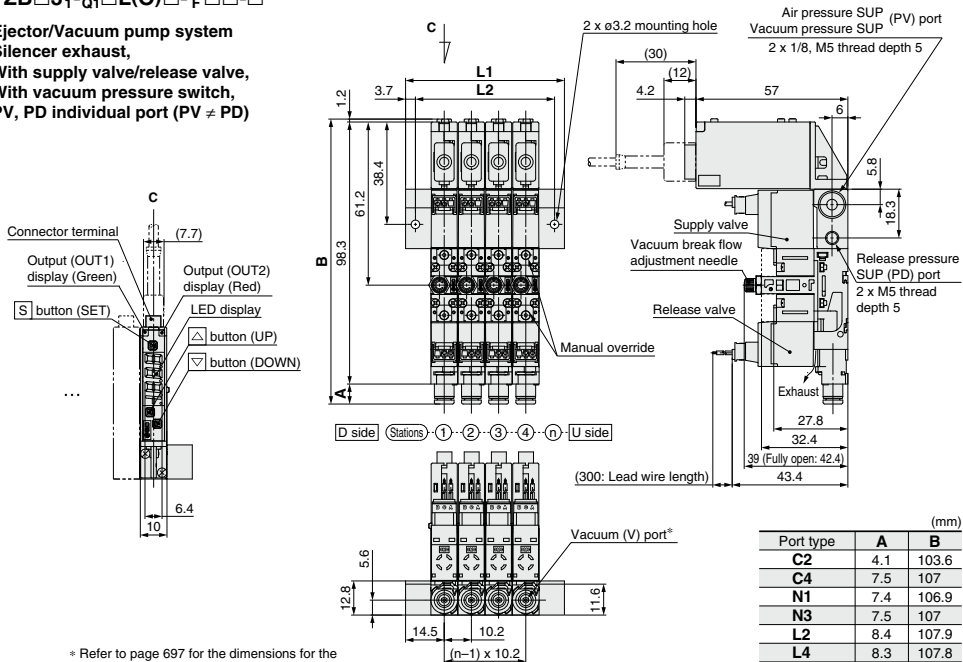

* Refer to page 697 for the dimensions for the various vacuum (V) ports.

Port type	A	B
C2	4.1	103.6
C4	7.5	107
N1	7.4	106.9
N3	7.5	107
L2	8.4	107.9
L4	8.3	107.8
LN1	8.3	107.8
LN3	8.3	107.8

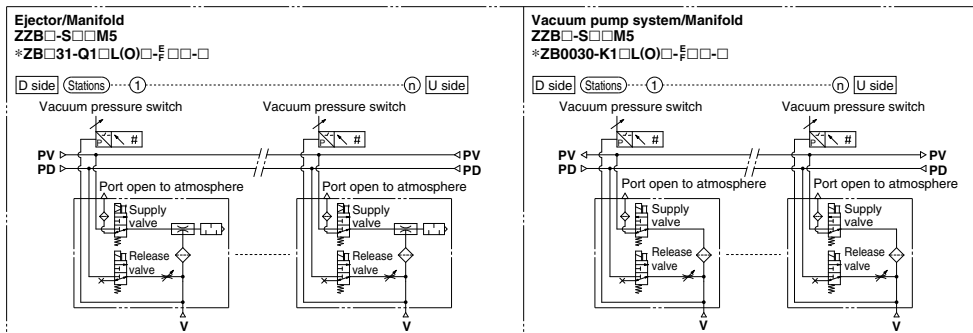

L	n	(mm)											
		1	2	3	4	5	6	7	8	9	10	11	12
L1		29	39.2	49.4	59.6	69.8	80	90.2	100.4	110.6	120.8	131	141.2
L2		21.6	31.8	42	52.2	62.4	72.6	82.8	93	103.2	113.4	123.6	133.8

Dimensions

■ V-port dimensions

● Straight type

C2: Straight
ø2 one-touch fitting

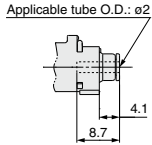

C4: Straight
ø4 one-touch fitting

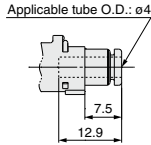

N1: Straight
ø1/8" one-touch fitting

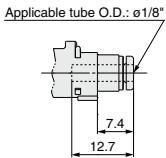

N3: Straight
ø5/32" one-touch fitting

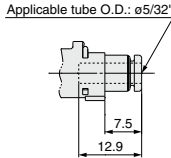

● Elbow type

L2: Elbow
ø2 one-touch fitting

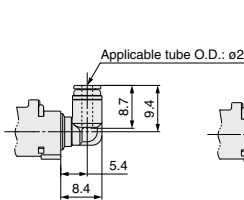

L4: Elbow
ø4 one-touch fitting

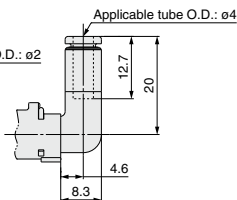

LN1: Elbow
ø1/8" one-touch fitting

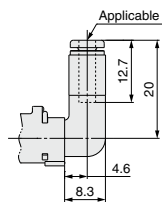

LN3: Elbow
ø5/32" one-touch fitting

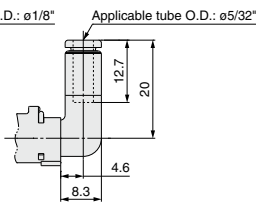

■ Common dimensions of the individual EXH port ZB□¹/₃2-□

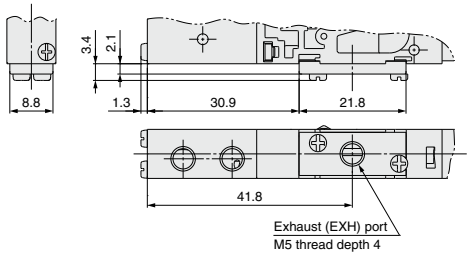

■ Bracket mounting dimensions for single unit

Bracket part number for single unit: **ZB1-BK1-A**

* Mounting screw (M2 x 14, with washer) 2 pcs., M2 nut 2 pcs. included

Mounting the right side of the unit to the outside

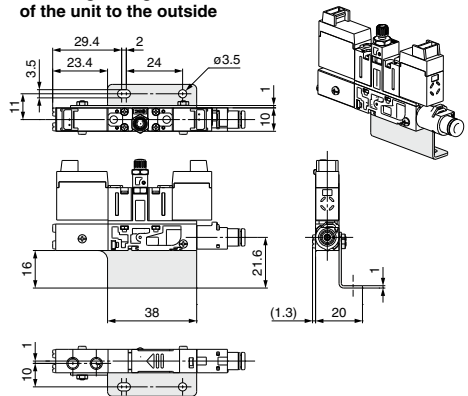

Mounting the left side of the unit to the inside

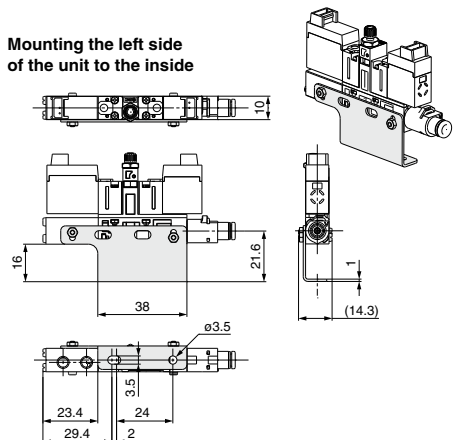



ZB Series

Specific Product Precautions 1

Be sure to read this before handling the products.

Refer to page 33 for safety instructions and pages 34 to 36 for vacuum equipment precautions.

Supply Valve/Release Valve

⚠ Caution

1. How to use the latching-type supply valve

Our latching-type solenoids are fitted with a self-detaining mechanism. Its construction features an armature inside the solenoid which is set or reset using spontaneous energization (20 ms or greater). Therefore, continuous energization is not required.

<Special care must be taken for the latching type.>

1. Avoid using this product with a circuit which electrifies both the set and reset signals simultaneously.
2. The minimum energization time required for self-detaining is 20 ms.
3. Contact SMC when using this product in locations where there are vibration levels of 30 m/s² or above or highly magnetic fields. No problems arise in normal usage or locations.
4. This supply valve retains the reset position (stops generation of vacuum) at the time of shipment. However, it may alter to the set position during transportation or due to vibration when mounting the supply valve. Therefore, confirm the home position either manually or with power supply prior to use.

Latching	Operation	Indicator light
A-C ON (Set)	Generates vacuum.	Orange
B-C ON (Reset)	Stops generation of vacuum.	Green

N.C.	Operation	Indicator light
A-C ON	Generates vacuum.	Orange
OFF	Stops generation of vacuum.	—

If the supply valve is latching type, continuous energization is not necessary because it maintains the switching position with momentary energization for at least 20 msec. Depending on the conditions, continuous energizing may cause operation failure such as ON operation failure due to operation voltage increase due to coil temperature rise.

When continuous energizing is necessary, the energizing time shall be 10 minutes or shorter. Before the next operation, the solenoid shall be de-energized (both A side and B side OFF) for longer than the energized time. Duty ratio shall be 50% or less.

2. Avoid energizing the supply valve/release valve for long periods of time.

If a supply valve/release valve is energized for a long period of time, the coil will get hot and the performance may be reduced. Additionally, the peripheral equipment in close proximity may also be badly affected. Use a latching-type supply valve when the supply valve/release valve is energized continuously or when the duration of the energization is longer than the non-energized period each day so that periods of energization can be shortened. But, do not energize the coil on both A and B sides simultaneously when using the latching type.

Continuous energization of the supply valve/release valve shall be 10 minutes or shorter in duration and the energization period shall be shorter than the non-energized period. Duty ratio shall be 50% or less.

Take measures for any heat radiation so that the temperature is within the range of supply valve/release valve general specifications when the valve is mounted on the control panel. Please pay special attention to any temperature increases when a manifold type with 3 stations or more is energized continuously or when 3 individual units are placed in close proximity.

How to Use the Supply Valve/Release Valve Plug Connector

⚠ Caution

Wiring Specifications

Wiring should be connected as shown below. Connect with the power supply respectively.

• N.C.

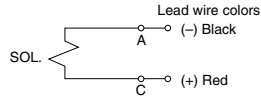

• Latching type (DC positive common)



Light/Surge Voltage Suppressor of the Supply Valve/Release Valve

⚠ Caution

In the latching type, the set side and the reset side energization are indicated by two colors – orange and green.

*() and the dotted lines indicate the latching and large flow type.

M-type plug connector

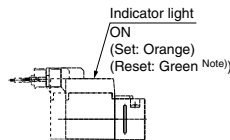

L-type plug connector

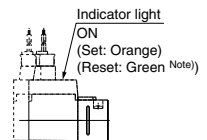

Note) In case of the latching type

• N.C.

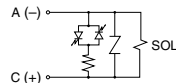

• Latching type (DC positive common)

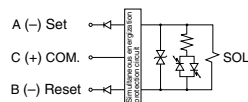

Specific Product Precautions 2



Be sure to read this before handling the products.

Refer to page 33 for safety instructions and pages 34 to 36 for vacuum equipment precautions.

Handling of the V-Port Assembly

⚠ Caution

1. The construction of the V-port assembly is such that it can be attached or detached at a touch.

When mounting or removing, turn the case completely until it reaches the position where it cannot turn any further. Otherwise, the V port may come off or be damaged.

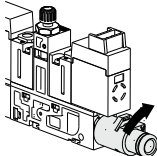

2. If it is mounted on the floor, remove the manifold base once from the installation position and lift the body to perform mounting and removal work so that the mounting and removal work can be performed more easily.

3. If the one-touch fitting is the straight type, a hexagon wrench (width across flats: 2 mm) can be used.

The hexagon hole is resin, so it can be broken if excess torque is applied. Do not apply torque of 0.15 N·m or more. Do not apply any more torque when it reaches the position where it cannot be turned further.

4. When inserting or removing a tube into or out of the one-touch fitting, hold the one-touch fitting body with your fingers.

Otherwise, excessive force can be applied to the V-port assembly or one-touch fitting assembly, causing air leakage or damage, etc.

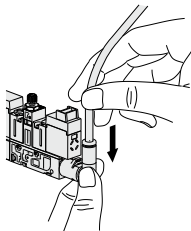

Especially if load is applied in the bending direction against the axial direction of the filter case, the case may be broken.

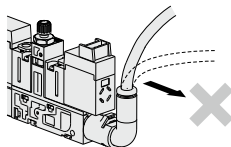

Operating Supply Pressure

⚠ Caution

1. Use the product within the specified supply pressure range.

Operation over the specified supply pressure range can cause damage to the product. Especially for the vacuum pump system with the adsorption nozzle, the pressure inside the product can increase due to the release pressure. Use the proper pressure and make sure that the adsorption part is not clogged.

Piping to the Manifold Base

⚠ Caution

1. For the PV port of the manifold base, use a fitting whose maximum bore size of the outside dimension is smaller than 12 mm.

Otherwise, the exterior of the fitting will interfere with the manifold base installation face.

Recommended fittings: KQ2S06-01□S, KQ2S04-01□S

2. When mounting or removing the fittings, etc. to and from the manifold base, hold the manifold base with a wrench.

If the ejector/vacuum pump system is held, it may cause air leakage or damage to the product.

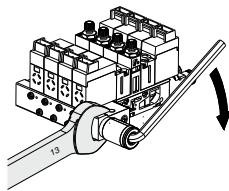

3. The tightening torque for each thread is shown below.

- 1/8 (PV port): 3 to 5 N·m

After tightening by hand, increase the tightening by 2 to 3 turns with a proper tightening tool.

- M5 (PV, PD port): After tightening by hand, increase the tightening by about 1/6 turn with a tightening tool.

Ejector Exhaust

⚠ Caution

1. The exhaust resistance should be as small as possible to obtain the full ejector performance.

There should be no shield around the exhaust port for the silencer exhaust specification. For the port exhaust specification, the back pressure increase should be 0.005 MPa (5 kPa) at maximum, as exhaust resistance is generated with some piping bore sizes and piping lengths. As a guide, keep the length not more than 1000 mm when the tube inside diameter is 4.

2. If the sound absorbing material is clogged, it will cause a reduction in the ejector performance.

In particular, if it is used in a dusty environment, not only the suction filter, but also the silencer can be clogged. It is recommended to replace the sound absorbing material periodically referring to the figure below.

Replacement Procedure

- 1) Turn the body upside down. Apply a watchmaker's screwdriver or your finger to the notch, and slide the silencer cover in the direction indicated by the △ mark.
- 2) It makes a click sound and the hook is disconnected. Put your nail to the part A and remove the cover.
- 3) Catch the sound absorbing material and pull it out using a watchmaker's screwdriver.
- 4) Insert a new sound absorbing material, and mount the cover by the reverse procedure of the disassembly procedure for reassembly. (Refer to page 691 for the replacement parts number.)

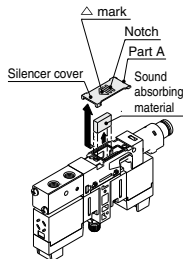

Specific Product Precautions 3

Be sure to read this before handling the products.

Refer to page 33 for safety instructions and pages 34 to 36 for vacuum equipment precautions.



Single Unit

⚠ Caution

1. Do not block the exhaust port of the ejector when the single unit ejector is mounted.

When the product is mounted so that the exhaust port side will be against a wall, use a spacer to secure a clearance of at least 1 mm. (Fig. 1)

For the single unit, PV port and PD port are oriented downward. When it is installed on a working table, use a bracket for single unit (Fig. 2) or secure a space for piping underneath the ports. (Fig. 3)

Bracket part number for single unit: ZB1-BK1-A

* Two mounting screws (M2 x 14, with washer) and two M2 nuts are included.

Recommended fittings: KQ2H04-M5□, KQ2L04-M5□, KQ2W04-M5□

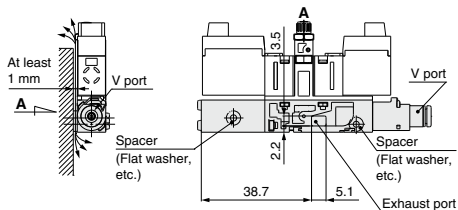

Fig. 1

Recommended fittings when using a bracket for single unit

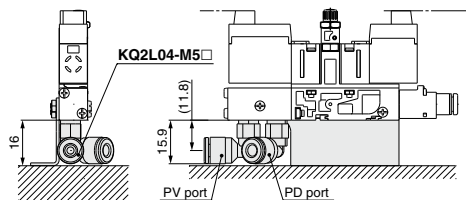

Fig. 2

Recommended fittings when the unit is mounted on the wall and the ports released to the atmosphere at the bottom

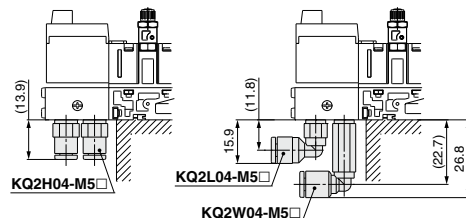

Fig. 3

Filter Case

⚠ Warning

1. The suction filter case is made using a special clear nylon. Do not use it in an atmosphere where it may come in contact with alcohol or other chemical agents.

Manifold

⚠ Caution

1. When increasing or decreasing the number of manifold stations, order the manifold base (1) exclusive for the required number of stations and the required number of single units of the body type 3 valve (2).

Refer to "How to Order" (pages from 684 to 686) for the part numbers for placing an order. The part number for the manifold base is different between the sensor/switch non-mountable base and sensor/switch mountable base.

When mounting, check that none of the gaskets, etc. is missing, and tighten the screws to the specified torque shown below.

If the tightening torque is exceeded, the body can be broken.

Proper tightening torque N·m
0.075 to 0.096

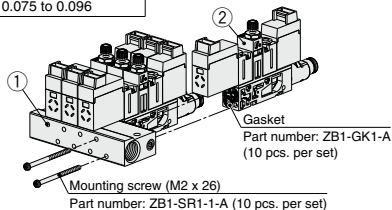

For the manifold with pressure sensor/vacuum pressure switch, order the manifold base (1) exclusive for the required number of stations and the required number of single units of the body type 3 valve (2), pressure sensor (3) or vacuum pressure switch (4).

In this case, the pressure sensor/vacuum pressure switch is tightened together with the single unit (2). (Refer to the figure below.)

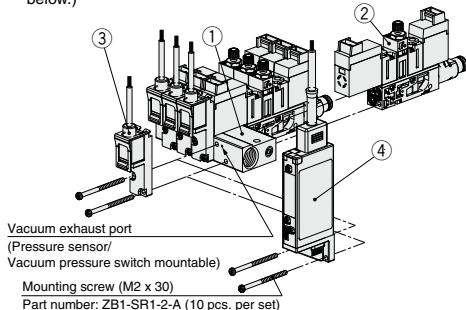

Take care not to drop the O-ring when mounting (3) and (4).

Specific Product Precautions 4



Be sure to read this before handling the products.

Refer to page 33 for safety instructions and pages 34 to 36 for vacuum equipment precautions.

Vacuum Break Flow Adjustment Needle

⚠ Caution

1. The flow rate characteristics show the representative values of the product itself.

They may change depending on piping, circuit and pressure conditions, etc. The flow rate characteristics and the number of rotations of the needle vary due to the range of the specifications of the product.

2. The needle has a retaining mechanism, so it will not turn further when it reaches the rotation stop position.

Turning the needle too far may cause damage.

3. Do not tighten the knob with tools such as nippers.

This can result in breakage due to idle turning.

Blanking Plate Assembly

⚠ Caution

1. When mounting the blanking plate assembly, tighten it with the torque shown below.
2. The blanking plate assembly can be used for either the pressure sensor/vacuum pressure switch mountable base or non-mountable base.
3. Mount the blanking plate assembly so that the gasket does not protrude from the plate.

Proper tightening torque N·m
0.075 to 0.096

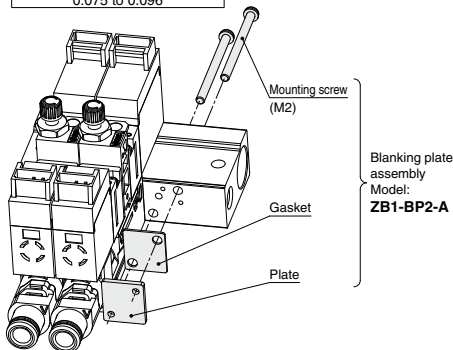

How to Use Pressure Sensor Assembly

Handling

⚠ Caution

1. Do not drop, bump or apply excessive impact (980 m/s²) when handling. Even if the switch body is not damaged, the switch may suffer internal damage that will lead to malfunction.
2. The tensile strength of the power cord is within 50 N, and pulling it with a greater force can cause failure. Hold the body when handling the product.

How to Use Pressure Sensor Assembly

Handling

⚠ Caution

3. Refer to the Operation Manual of the pressure sensor PSE540 series for how to connect the connectors for sensor.

Environment

⚠ Caution

1. The use of resin piping can cause static electricity to be generated, depending on the fluid. Therefore, when connecting this switch/sensor, take appropriate measures against static electricity at the equipment side to which this product is mounted, and separate the grounding for the product from the grounding for any equipment which generates a strong electromagnetic noise or high frequency. Otherwise, static electricity can break the switch/sensor.

How to Use Vacuum Pressure Switch Assembly

Handling

⚠ Caution

1. Do not drop, bump or apply excessive impact (100 m/s²) when handling. Even if the sensor body is not damaged, the sensor may suffer internal damage that will lead to malfunction.
2. The tensile strength of the power cord is 35 N, and pulling it with a greater force can cause failure. Hold the body when handling the product.
3. Do not allow repeated bending or stretching forces to be applied to lead wires. Wiring arrangements in which repeated bending stress or stretching force is applied to the lead wires can cause broken wires. If the lead wire can move, fix it near the body of the product. The recommended bending radius of the lead wire is 6 times the outside diameter of the sheath, or 33 times the outside diameter of the insulation material, whichever is larger.

Connection

⚠ Caution

1. Incorrect wiring can cause the switch to be damaged or malfunction. Connections should only be made when the power supply is turned off.
2. Do not attempt to insert or pull out the connector from the switch while the power is on. Otherwise, it may cause switch output malfunction.
3. Malfunctions stemming from noise may occur if the wire is installed in the same route as that of power or high-voltage cable. Wire the switch independently.
4. Be sure to connect the ground terminal F.G. to ground when using a commercially available switch-mode power supply.



ZB Series Specific Product Precautions 5

Be sure to read this before handling the products.
Refer to page 33 for safety instructions and pages 34 to 36 for vacuum equipment precautions.

How to Use Vacuum Pressure Switch Assembly

Environment

Warning

1. The structure of pressure switches is not intended to prevent explosion. Never use in an atmosphere of flammable gas or explosive gas.

Caution

1. The product is CE/UKCA marked, but not immune to lightning strikes. Take measures against lightning strikes in your system.
2. Do not use the switches in locations where static electricity would be problematic; it may result in the system failure and trouble.

Assembling/Removing Connectors

Caution

- When assembling the connector to the switch housing, push the connector straight onto the pins until the level locks into the housing slot.
- When removing the connector from the switch housing, push the section A (lever) down with your thumb to unlock it from the slot and then withdraw the connector straight off of the pins.

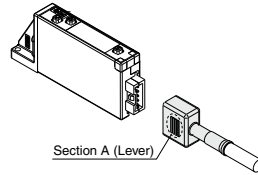

- Do not attempt to insert or pull out the connector from the switch while the power is on. Otherwise, it may cause switch output malfunction.

Supply Valve/Release Valve

Warning

- When wiring to the solenoid valve, be sure not to mistake the release valve for the supply valve. Such a mistake may result in injury or equipment damage.
- For the lead wire with a dedicated IO-Link connector, wire the lead wire with the wire mark to the supply valve.

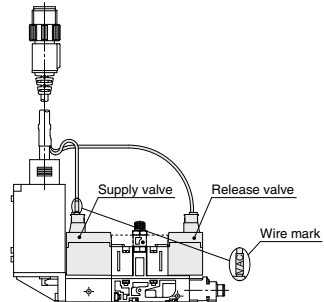

Set Pressure Range and Rated Pressure Range

Caution

Set the pressure to a value within the rated pressure range.

Set pressure range is the range within which the pressure can be set.

Rated pressure range is the pressure range within which the specifications of the switch (accuracy, linearity, etc.) can be satisfied.

Values outside of this range can be set as long as they are within the set pressure range, but the specifications cannot be guaranteed.

Switch	Pressure range				
	-100 kPa	0	100 kPa	500 kPa	1 MPa
For vacuum ZB1-ZSE	-101 kPa	0	10 kPa		
For compound pressure ZB1-ZSF	-100 kPa		100 kPa		
	-105 kPa		105 kPa		

■ Rated pressure range of switch
■ Set pressure range of switch