

Air Checker: Electronic Pressure Switch

PS1000/PS1100/PS1200 Series

(For Positive Pressure) (For Vacuum, Residual Pressure) (For Vacuum)

Applicable fluid:
Air, Non-corrosive gas, Non-flammable gas



Compact/lightweight
electronic pressure switch

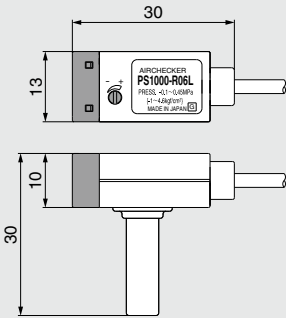
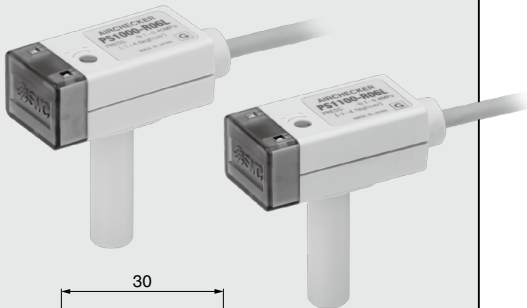

Addition of vacuum range (-100 to 0 kPa)
Easy adjustment of pressure setting trimmer

220°

Positive pressure adjustment range

0 MPa
Vacuum adjustment range

-100 kPa 0 kPa PS1200 (For vacuum)

-0.1 MPa 0.45 MPa/0.4 MPa PS1000/1100

ZSE20
ISE20
ZSE30
ISE30
ZSE40
ISE40
ZSE10
ISE10
ISE70
ZSE80
ISE80
PS
ISA3
ISA2
ISE35
PSE
IS
ISG
ZSM1

Easy mounting

Plug-in reducer port for One-touch fittings

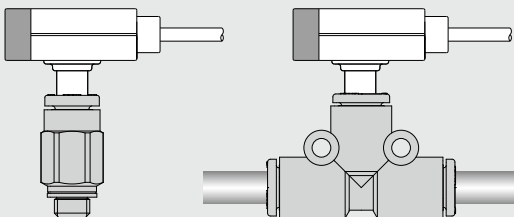

High visibility

A large LED display for an easily visible switch

2-wire type

Applicable to either NPN or PNP output

Air Checker: Electronic Pressure Switch

PS1000/1100/1200 Series



How to Order

PS 10 00 - R06 L - Q

Output specifications

10	For positive pressure
11	For vacuum and residual pressure
12	For vacuum

Piping specifications

R06	ø6 reducer
R07	1/4" reducer

Option (CE-compliant*)

Nil	None
Q	CE-compliant

* The PS1200 series is CE-compliant (with Q) only.

Lead wire length

L	3 m
---	-----

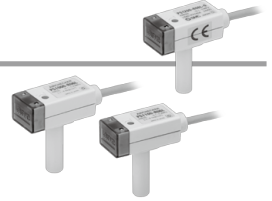

Refer to pages 11 and 12 for Pressure Switch Precautions. For details about the Specific Product Precautions, refer to the Operation Manual on the SMC website, <http://www.smcworld.com> Click [here](#) for details.

Specifications

Model	PS1000	PS1100	PS1200
Switch output	Present pres. ≥ Setting pres.: ON		Present pres. ≤ Setting pres.: ON
Max. operating pressure	1 MPa		500 kPa
Set pressure range	-0.1 to 0.45 MPa	-0.1 to 0.4 MPa	
Fluid	Air/Non-corrosive gas/Non-flammable gas		
Indicator light	ON: When red LED turns on		
Temperature characteristics	±3% F.S.		
Repeatability	±1% F.S.		
Hysteresis	4% F.S. or less		10% F.S. or less
Load voltage	12 to 24 VDC ±10%, Ripple (p-p) 10% or less		
Load current	5 to 40 mA		
Leakage current	1 mA or less		
Internal voltage drop	5 V or less		
Operating temperature range	0 to 60°C (No condensation)		
Insulation resistance	2 MΩ or more (500 VDC measured via megohmmeter) between terminals and housing		
Withstand voltage	1000 VAC (in 50/60 Hz) for 1 minute between terminals and housing		
Weight	5 g (Excluding lead wire)		
Port size	R06: ø6 reducer, R07: 1/4" reducer		
Enclosure	IP40		
Lead wire	Grommet oilproof heavy-duty vinyl cable 2 cores, ø2.55, 3 m, Conductor area: 0.18 mm ² , Insulator O.D.: 0.96 mm		
Wetted parts material	Pressured sensor part: Silicon, Body part: PBT, O-ring: NBR		
Standards	CE (Option), RoHS		

Switch Specifications

PS1000, PS1100

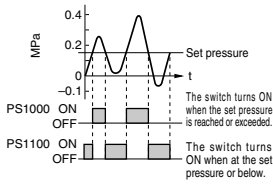

PS1200

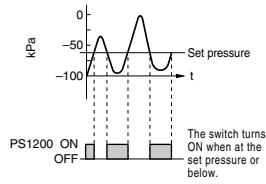

Setting of Pressure Switch

- Use the pressure setting trimmer to set ON pressure.
- Rotate clockwise to increase the set pressure. For setting vacuum, rotate counterclockwise.
- To set, use a flat head screwdriver suited for the groove of the trimmer, and rotate it lightly with finger tip.

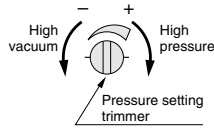

Trimmer

Rotation angle of the trimmer is 220°.

There is a stop provided to prevent the trimmer from rotating beyond its limits. Rotation beyond the limit can damage the trimmer. Adjust the trimmer gently within the rotation angle.

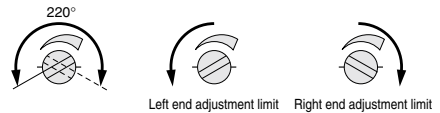

Internal Circuits and Wiring Examples

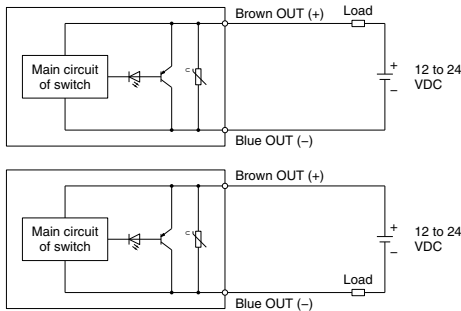

Example of connection with a PLC (Sequence controller)

For source type input unit

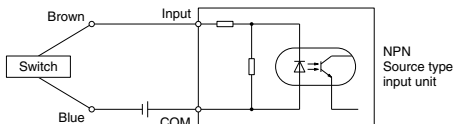

For sink type input unit

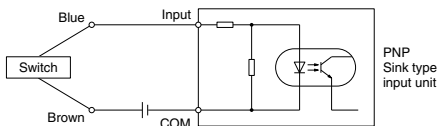

Dimensions

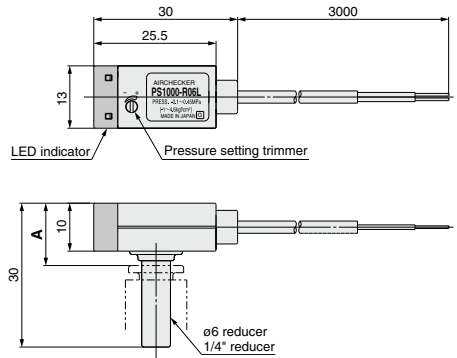

Dimensions

Applicable One-touch fittings	A
KQ2H/L/T/S/Y06-M5	16
KQ2H/L07-M5	16
Other KQ2/KS series	13
KJ series	16

ZSE20
ISE20

ZSE30
ISE30

ZSE40
ISE40

ZSE10
ISE10

ISE70

ZSE80
ISE80

PS

ISA3

ISA2

ISE35

PSE

IS

ISG

ZSM1