

Stopper Cylinder Fixed Mounting Height

RSQ Series

ø12, ø16, ø20, ø32, ø40, ø50



How to Order

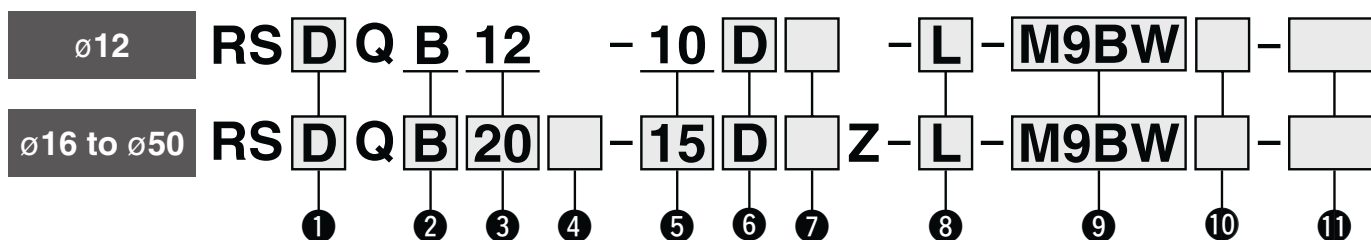

1 With auto switch

Nil	Without magnet for switch*1
D	With auto switch (Built-in magnet)

*1 In the case of without magnet for switch, auto switch cannot be mounted.

2 Mounting

B	Through-hole
A	Both ends tapped

* Since ø12 uses a common tube for both A and B, only B is used for part no. denotation.

3 Bore size

12	12 mm
16	16 mm
20	20 mm
32	32 mm
40	40 mm
50	50 mm

4 Port thread type

Nil	M thread	ø12, ø16
	Rc	ø20 to ø50
TN	NPT	
TF	G	
F	Built-in One-touch fittings*2	

*2 Bore sizes available w/ One-touch fittings are ø20 to ø50.

* TF for ø20 indicates M5.

5 Cylinder stroke [mm]

12	10
16	10, 15
20	10, 15, 20
32	10, 15, 20
40	20, 25, 30
50	20, 25, 30

6 Action

D	Double acting
B	Double acting with spring loaded
T	Single acting / spring extend

7 Rod end configuration

Nil	Round bar
F	Round bar with female rod end*3
K	Chamfered
G	Chamfered with female rod end*3
R	Roller
L	Lever (Fixed absorber type)
B	Lever (Adjustable absorber type)
C	Lever (Adjustable absorber type) with cancel cap
D	Lever (Adjustable absorber type) with lock mechanism
E	Lever (Adjustable absorber type) with lock mechanism and cancel cap

* The lever type rod end is applicable only to bore sizes ø32, ø40, and ø50.

*3 Excluding ø12

8 Mounting bolt

Nil	None
L	Shipped together

* Mounting bolt is shipped together only when the "Mounting" symbol is B. For details about the mounting bolt sizes, refer to page 562.

9 Auto switch

Nil	Without auto switch
-----	---------------------

* For applicable auto switches, refer to the table below.

10 Number of auto switches

Nil	2
S	1

11 Made to order

For details, refer to page 561.

Applicable Auto Switches/Refer to pages 941 to 1067 for further information on auto switches.

Type	Special function	Electrical entry	Indicator light	Wiring (Output)	Load voltage		Auto switch model		Lead wire length [m]					Pre-wired connector	Applicable load								
					DC	AC	Perpendicular	In-line	0.5 (Nil)	1 (M)	3 (L)	5 (Z)	None (N)		IC circuit	Relay, PLC							
Solid state auto switch	—	Grommet	Yes	3-wire (NPN)	24 V	5 V, 12 V	—	M9NV	M9N	●	●	●	○	—			○	IC circuit	Relay, PLC				
				3-wire (PNP)				M9PV	M9P	●	●	●	○	—	○								
				2-wire				M9BV	M9B	●	●	●	○	—	○	—							
				3-wire (NPN)				M9NW	M9NW	●	●	●	○	—	○	—							
	Diagnostic indication (2-color indicator)			3-wire (PNP)				M9PWV	M9PW	●	●	●	○	—	○	—	○			—	○		
				2-wire				M9BWBV	M9BW	●	●	●	○	—	○	—	○			—	○		
	Water-resistant (2-color indicator)			3-wire (NPN)				M9NAV*1	M9NA*1	○	○	●	○	—	○	—	○			—	○	—	○
				3-wire (PNP)				M9PAV*1	M9PA*1	○	○	●	○	—	○	—	○			—	○	—	○
Magnetic field-resistant (2-color indicator)	2-wire	M9BAV*1	M9BA*1	○	○	●	○	—	○	—	○	—	○	—	○								
	2-wire (Non-polar)	—	P3DWA	●	—	●	—	—	—	—	—	—	—	—	—								
Reed auto switch	—	Grommet	Yes	3-wire (NPN equivalent)	24 V	5 V	—	A96V	A96	●	—	●	—	—	—	—	—						
				2-wire				A93V*2	A93	●	●	●	●	—	—	—	—	—					
				—				A90V	A90	●	—	●	—	—	—	—	—	—					

*1 Water-resistant type auto switches can be mounted on the above models, but SMC cannot guarantee water resistance.

Please contact SMC regarding water-resistant types with the above model numbers.

*2 The 1 m lead wire is only applicable to the D-A93.

* Lead wire length symbols: 0.5 m..... Nil (Example) M9NW
 1 m..... M (Example) M9NWM
 3 m..... L (Example) M9NWL
 5 m..... Z (Example) M9NWZ

* Solid state auto switches marked with "○" are produced upon receipt of order.

* The D-P3DWA□ is mountable on bore size ø32 to ø50.

* Since there are applicable auto switches other than those listed above, refer to page 574-1 for details.



Specifications

Bore size [mm]	12	16	20	32	40	50
Action	Double acting, Double acting with spring loaded, Single acting / spring extend					
Fluid	Air					
Proof pressure	1.5 MPa					
Maximum operating pressure	1.0 MPa					
Ambient and fluid temperatures	Without auto switch: -10°C to 70°C With auto switch: -10°C to 60°C (No freezing)					
Lubricant	Not required (Non-lube)					
Cushion	Rubber bumper					
Stroke length tolerance	+1.4*1 0					
Piston speed	50 to 500 mm/s					
Mounting	Through-hole, Both ends tapped					

*1 Stroke length tolerance does not include the amount of bumper change.

Standard Strokes

Bore size	Rod end configuration	
	Round bar, Chamfered, Roller	Lever
12	10	—
16	10, 15	—
20	10, 15, 20	—
32		10, 15, 20
40	20, 25, 30	20, 25, 30
50		20, 25, 30



Made to Order
Common Specifications
[Click here for details](#)

Symbol	Specifications
-XA□	Change of rod end shape
-XB11	Long stroke type*1
-XC3	Special port location

*1 Double acting, Round bar type only.

For details on the water-resistant cylinder and the series compatible with secondary batteries (25A-), refer to the **Web Catalog**.

For details of cylinders **with auto switches** ⇨ pages 572 to 574-1

- Auto Switch Proper Mounting Position (Detection at stroke end) and Mounting Height
- Operating Range
- Auto Switch Mounting Brackets/Part Nos.

Spring Force (Single acting / spring extend)

Bore size [mm]	Extended	Compressed
12	3.9	9.6
16	4.9	14.9
20	3.4	14.9
32	8.8	18.6
40, 50	13.7	27.5

* Applicable only to round bar, chamfered, and roller type rod end configurations.

RSQ

RSG

RS2H

RSH

**MIW
MIS**

D-□

-X□

RSQ Series

Type

Bore size [mm]		12	16	20	32	40	50
Mounting	Through-hole	●*1	●	●	●	●	●
	Both ends tapped	●	●	●	●	●	●
Built-in magnet			●	●	●	●	●
Piping	Screw-in	M5 x 0.8		1/8*2			
	Built-in One-touch fittings	—		ø6/4			ø8/6
Action		Double acting, Double acting with spring loaded, Single acting / spring extend					
Rod end configuration	Round bar				●		
	Chamfered				●		
	Roller				●		
	Lever		—			●	

*1 ø12 tubes can have both through-hole and tap mountings in the same tube.

*2 TF (G thread) for ø20 indicates M5 x 0.8.

Weight

Action	Bore size [mm]	Rod end configuration	Cylinder stroke [mm]				
			10	15	20	25	30
Double acting	12	Round bar, Chamfered, Roller	0.07	—	—	—	—
	16	Round bar, Chamfered, Roller	0.13	0.14	—	—	—
	20	Round bar, Chamfered, Roller	0.22	0.23	0.24	—	—
Double acting with spring loaded	32	Round bar, Chamfered, Roller	0.41	0.43	0.45	—	—
		Lever	0.50	0.52	0.54	—	—
Single acting / spring extend	40	Round bar, Chamfered, Roller	—	—	0.73	0.79	0.85
		Lever	—	—	0.96	1.00	1.04
	50	Round bar, Chamfered, Roller	—	—	0.98	1.02	1.06
		Lever	—	—	1.21	1.25	1.29

Mounting Bolt for RSQB

Mounting bolts for the RSQB are available. Refer to the following mounting bolt part numbers.

Order the actual number of bolts that will be used.

Example) CQ-M3X55L 2 pcs.

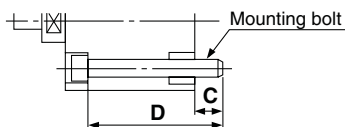

Cylinder model	C	D	Mounting bolt part no.
*1 RSQB12-10□	5	45	CQ-M3X45L
RSQB16-10□	7.5	55	CQ-M3X55L
-15□		60	X60L
RSQB20-10□	7	55	CQ-M5X55L
-15□		60	X60L
-20□		65	X65L
RSQB32-10□	9	60	CQ-M5X60L
-15□		65	X65L
-20□		70	X70L
RSQB40-20□	9.5	75	CQ-M5X75L
-25□		80	CQ-M5X80L
-30□		85	X85L
RSQB50-20□	9	75	CQ-M6X75L
-25□		80	X80L
-30□		85	X85L

*1 Be sure to use the attached flat washers when mounting ø12 cylinders with through-holes.

RSQ

RSG

RS2H

RSH

MIW

MIS

D-□

-X□

RSQ Series

Construction

Double acting (D)

Rod end configuration: Roller (R)

ø12

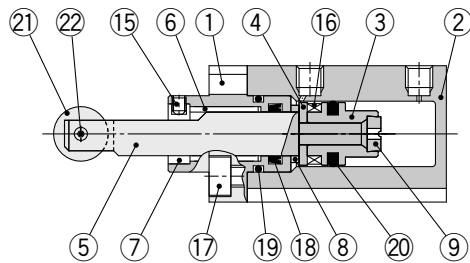

ø16

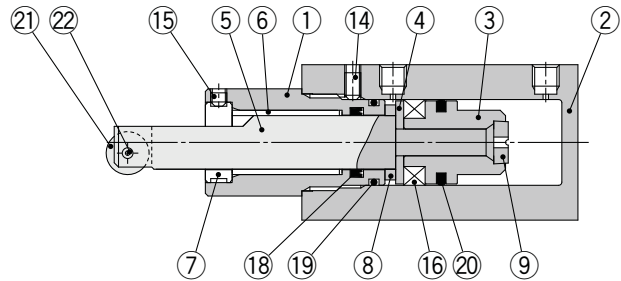

ø20

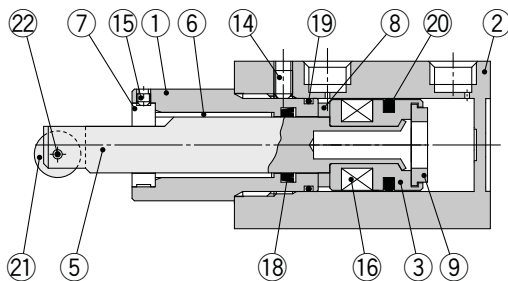

ø32, ø40, ø50

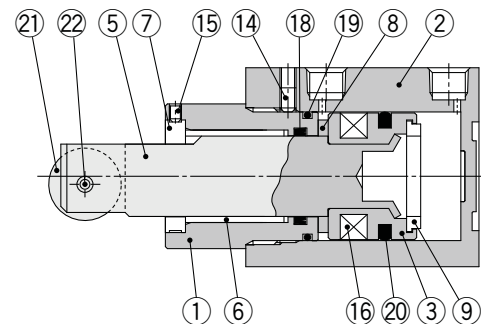

Double acting with spring loaded (B)

ø12, ø16

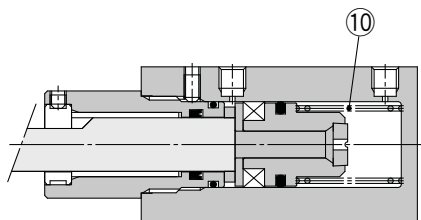

ø20, ø32, ø40, ø50

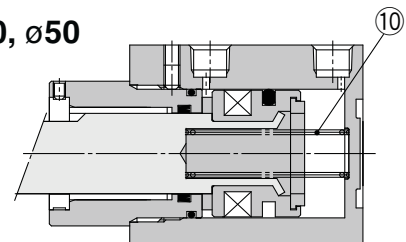

Single acting / spring extend (T)

ø12, ø16

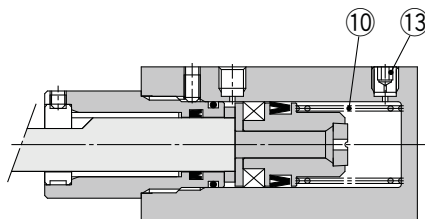

ø20, ø32, ø40, ø50

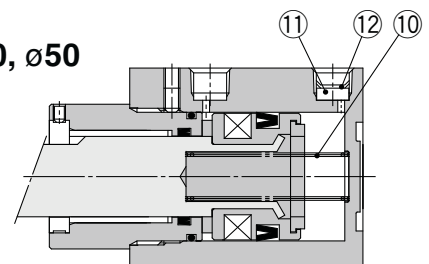

Component Parts

No.	Description	Material	Note
1	Rod cover	Aluminum alloy	Anodized
2	Cylinder tube	Aluminum alloy	Hard anodized
3	Piston	Aluminum alloy	
4	Spacer for switch	Aluminum alloy	ø12, ø16 only
5	Piston rod	ø12, ø16, ø20: Stainless steel ø32, ø40, ø50: Carbon steel	Hard chrome plating
6	Bushing	Bearing alloy	
7	Non-rotating guide	Rolled steel	Non-rotating type only Excluding the round bar type rod end
8	Bumper A	Urethane	
9	Bumper B	Urethane	
10	Return spring	Steel wire	Zinc chromated (Excluding double acting)
11	Element	Sintered metallic BC	ø20 to ø50 only (Single acting only)

No.	Description	Material	Note
12	Retaining ring	Carbon tool steel	ø20 to ø50 only (Single acting only)
13	Plug with fixed orifice	Alloy steel	ø12, ø16 only (Single acting only)
14	Hexagon socket head set screw	Chromium molybdenum steel	Excluding ø12
15	Hexagon socket head set screw	Chromium molybdenum steel	Non-rotating type only Excluding the round bar type rod end
16	Magnet	—	
17	Hexagon socket head cap screw	Alloy steel	ø12 only
18	Rod seal	NBR	
19	Gasket	NBR	
20	Piston seal	NBR	
21	Roller A	Resin	
22	Spring pin	Carbon tool steel	

Construction

Rod end configuration:

Round bar (Nil)

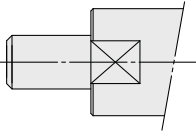

Round bar with female thread (F)

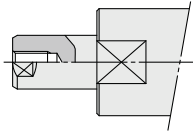

Chamfered (K)

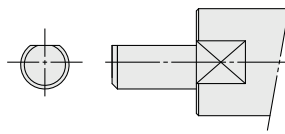

Chamfered with female thread (G)

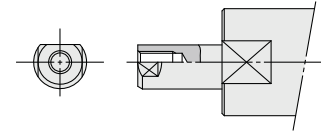

Lever (Fixed absorber type)
($\varnothing 32$, $\varnothing 40$, $\varnothing 50$ only)

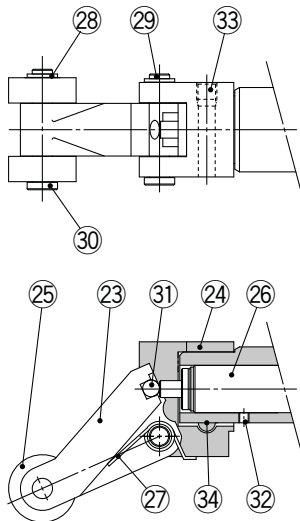

Lever (Adjustable absorber type)
($\varnothing 32$, $\varnothing 40$, $\varnothing 50$ only)

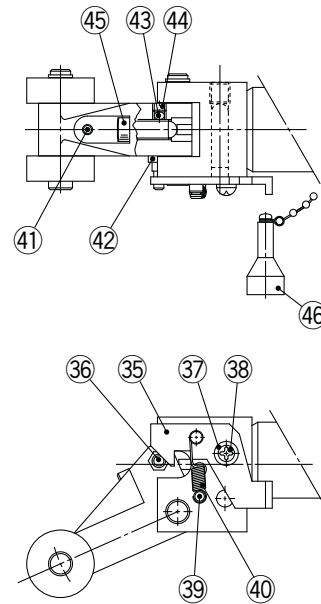

Only one roller is provided for $\varnothing 32$.

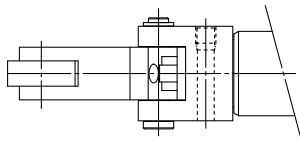

Component Parts

No.	Description	Material	Note
23	Lever	Cast iron	
24	Lever holder	Rolled steel	
25	Roller B	Resin	
26	Shock absorber	—	
27	Lever spring	Stainless steel wire	
28	C retaining ring for axis	Carbon tool steel	
29	Lever pin	Carbon steel	
30	Roller pin	Carbon steel	
31	Steel ball	High carbon chrome bearing steel	
32	Hexagon socket head set screw	Chromium molybdenum steel	
33	Hexagon socket head set screw	Chromium molybdenum steel	
34	One-side tapered pin	Carbon steel	

No.	Description	Material	Note
35	Bracket	Carbon steel	
36	Pin B	Carbon steel	
37	Spacer	Carbon steel	
38	Cross recessed round head screw	Rolled steel	
39	Pin A	Rolled steel	
40	Bracket spring	Steel wire	
41	Hexagon socket head set screw	Chromium molybdenum steel	
42	Spring washer	Steel wire	
43	Urethane ball	Urethane	
44	Hexagon socket head set screw	Chromium molybdenum steel	
45	Adjustment bolt	Bearing steel	
46	Cancel cap	Aluminum alloy	

Replacement Parts: Seal Kit

Bore size [mm]	Kit no.			Contents
	Double acting	Double acting with spring loaded	Single acting / spring extend	
12	RSQ12D-PS	RSQ12T-PS		Set of nos. 18, 19, 20 on page 564
16	RSQ16D-PS	RSQ16B-PS	RSQ16T-PS	
20	RSQ20D-PS	RSQ20B-PS	RSQ20T-PS	
32	RSQ32D-PS	RSQ32B-PS	RSQ32T-PS	
40	RSQ40D-PS	RSQ40B-PS	RSQ40T-PS	
50	RSQ50D-PS	RSQ50B-PS	RSQ50T-PS	

* The seal kit includes 18, 19, and 20. Order the seal kit based on each bore size.

* The seal kit does not include a grease pack. Order it separately.

Grease pack part number: GR-S-010 (10 g)

Replacement Parts: Shock Absorber

Bore size [mm]	Kit no.
32	RB1007-X225
40, 50	RB1407-X552

RSQ

RSG

RS2H

RSH

MIW

MIS

D-□

-X□

RSQ Series

These 6 figures show the piston rod extended.
The dimensions of the double acting type with spring loaded, and single acting/spring extend type are the same as those of the double acting type.

Dimensions

Rod end configuration: Round bar, Mounting: Through-hole

Bore size: $\varnothing 12$ RS□QB12-10D (Double acting)

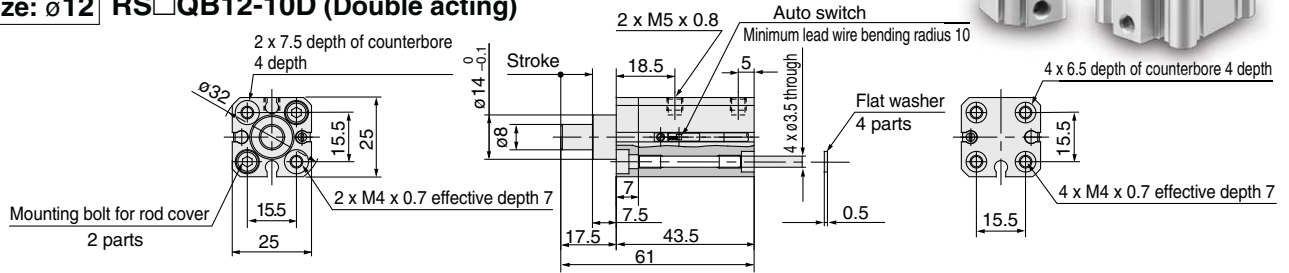

Bore size: $\varnothing 16, \varnothing 20$ RS□QB₂₀¹⁶□-□DZ (Double acting)

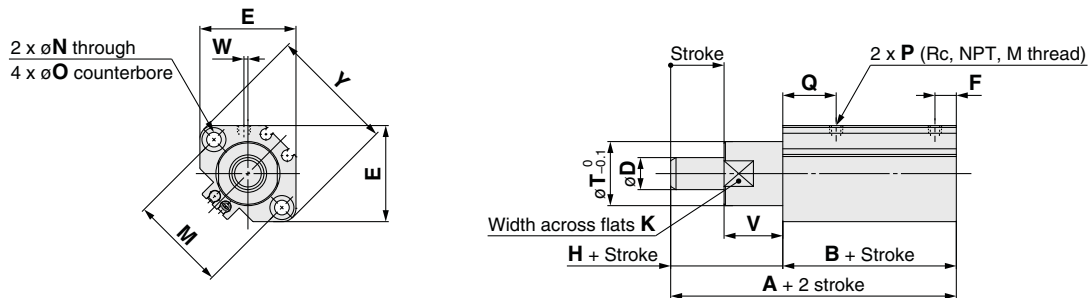

Bore size: $\varnothing 32, \varnothing 40, \varnothing 50$ RS□QB₅₀³²□-□DZ (Double acting)

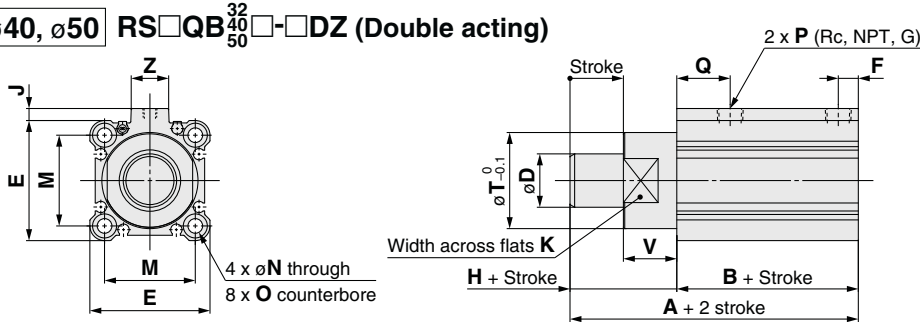

Mounting: Both ends tapped RS□QA

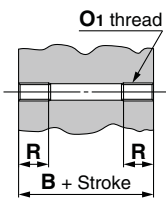

Bore size	B	O ₁	R
16	41.5	M4 x 0.7	7
20	45	M6 x 1	10
32	48	M6 x 1	10
40	52.5	M6 x 1	10
50	54	M8 x 1.25	14

* Dimensions other than those shown above are the same as the drawings above.

Female rod end

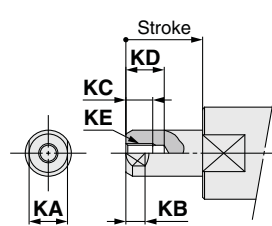

Bore size	KA	KB	KC	KD	KE
16	8	4.5	8	10.5	M4 x 0.7
20	10	5	7	10	M5 x 0.8
32	17	7.5	13	16.5	M8 x 1.25
40	22	9.5	13	16.5	M8 x 1.25
50	22	9.5	13	16.5	M8 x 1.25

Built-in One-touch fittings ($\varnothing 20$ to $\varnothing 50$)

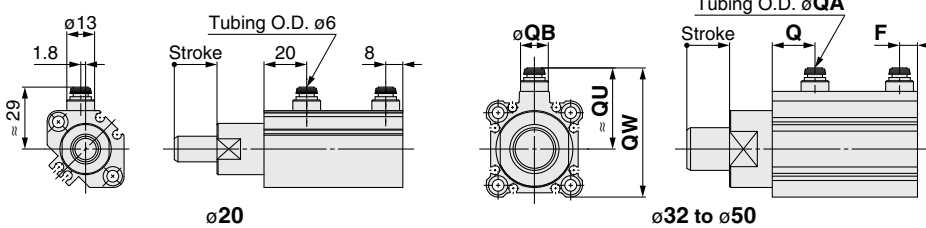

Bore size	QA	F	Q	QB	QU	QW
32	6	7.5	20	13	38	60.5
40	6	8	24.5	13	42	68
50	8	9.5	26	16	50	82

Bore size	A	B	D	E	F	H	J	K	M	N	O	P			Q	T	V	Y	Z	W		
												Rc	NPT	G						Rc	NPT	G
16	59.5	41.5	10	29	6	18	—	18	28	3.5	6.5 depth 4	M5 x 0.8	M5 x 0.8	M5 x 0.8	17	20	18	37	—	0	0	0
20	67	45	12	36	8	22	—	22	36	5.5	9 depth 7	1/8	1/8	M5 x 0.8	20	24	22	47	—	1.5	1.5	0
32	68	48	20	45	7.5	20	4.5	32	34	5.5	9 depth 7	1/8	1/8	1/8	20	36	20	—	14	—	—	—
40	80.5	52.5	25	52	8	28	5	41	40	5.5	9 depth 7	1/8	1/8	1/8	24.5	44	28	—	15	—	—	—
50	82	54	25	64	8	28	7	50	50	6.6	11 depth 8	1/8	1/8	1/8	24.5	56	28	—	19	—	—	—

* Refer to pages 572 and 573 for the auto switch proper mounting position and mounting height.

* For the single acting type, a One-touch fitting is on the rod end only. * The position of the width across flats (K) is arbitrary and is not specified.

Stopper Cylinder **RSQ Series**



These 4 figures show the piston rod extended.
The dimensions of the double acting type with spring loaded, and single acting/spring extend type are the same as those of the double acting type.

Dimensions

Rod end configuration: Chamfered (Non-rotating piston rod)

Mounting: Through-hole

Bore size: $\phi 12$ RS□QB12-10DK (Double acting)

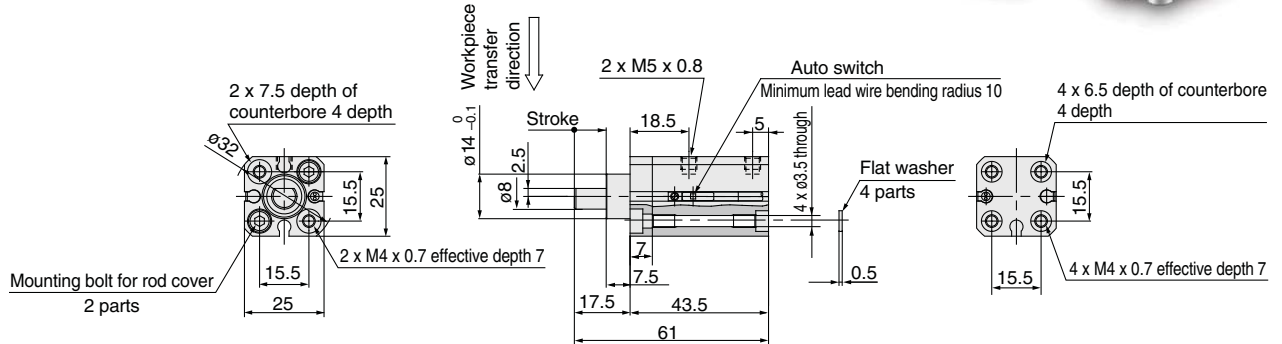

Bore size: $\phi 16, \phi 20$ RS□QB¹⁶₂₀□-□DKZ (Double acting)

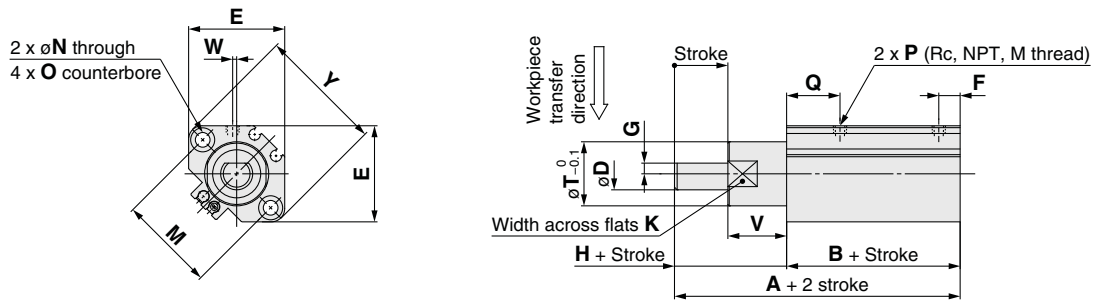

Bore size: $\phi 32, \phi 40, \phi 50$ RS□QB³²₄₀₅₀□-□DKZ (Double acting)

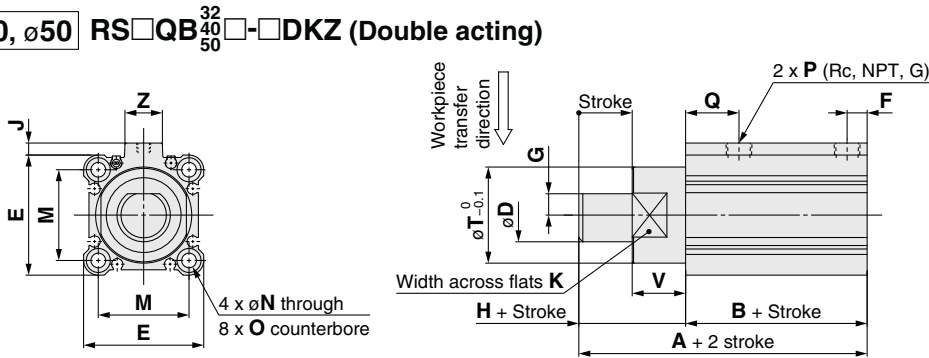

Mounting: Both ends tapped

RS□QA

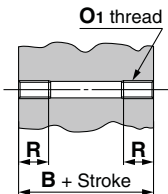

Bore size	B	O ₁	R
16	41.5	M4 x 0.7	7
20	45	M6 x 1	10
32	48	M6 x 1	10
40	52.5	M6 x 1	10
50	54	M8 x 1.25	14

* Dimensions other than those shown above are the same as the drawings above.

Female rod end

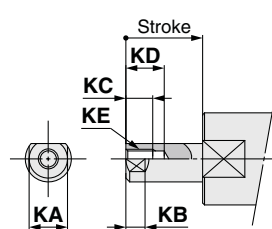

Bore size	KA	KB	KC	KD	KE
16	8	4.5	8	10.5	M4 x 0.7
20	10	5	7	10	M5 x 0.8
32	17	7.5	13	16.5	M8 x 1.25
40	22	9.5	13	16.5	M8 x 1.25
50	22	9.5	13	16.5	M8 x 1.25

Refer to page 566 for dimensions of the model with built-in One-touch fittings.

Bore size	A	B	D	E	F	G	H	J	K	M	N	O	P			Q	T	V	Y	Z	W		
													Rc	NPT	G						Rc	NPT	G
16	59.5	41.5	10	29	6	3	18	—	18	28	3.5	6.5 depth 4	M5 x 0.8	M5 x 0.8	M5 x 0.8	17	20	18	37	—	0	0	0
20	67	45	12	36	8	4	22	—	22	36	5.5	9 depth 7	1/8	1/8	M5 x 0.8	20	24	22	47	—	1.5	1.5	0
32	68	48	20	45	7.5	8	20	4.5	32	34	5.5	9 depth 7	1/8	1/8	1/8	20	36	20	—	14	—	—	—
40	80.5	52.5	25	52	8	10	28	5	41	40	5.5	9 depth 7	1/8	1/8	1/8	24.5	44	28	—	15	—	—	—
50	82	54	25	64	8	10	28	7	50	50	6.6	11 depth 8	1/8	1/8	1/8	24.5	56	28	—	19	—	—	—

* Refer to pages 572 and 573 for the auto switch proper mounting position and mounting height.

* For the single acting type, a One-touch fitting is on the rod end only. * The position of the width across flats (K) is arbitrary and is not specified.

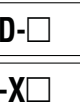



These 2 figures show the piston rod extended.
The dimensions of the double acting type with spring loaded, and single acting/
spring extend type are the same as those of the double acting type.

Dimensions

Rod end configuration: **Lever (Fixed absorber type), Mounting: Through-hole**

Bore size: $\phi 32$ RS□QB32□-□DLZ (Double acting)

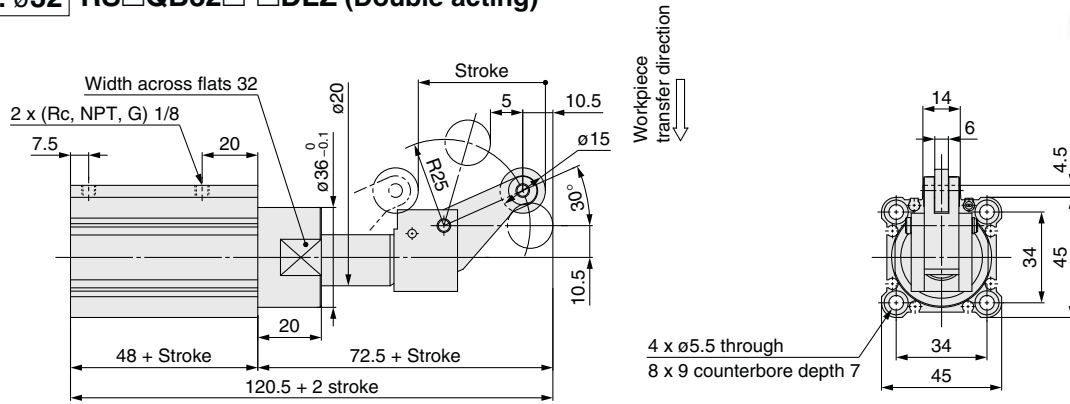

Bore size: $\phi 40, \phi 50$ RS□QB₅₀⁴⁰□-□DLZ (Double acting)

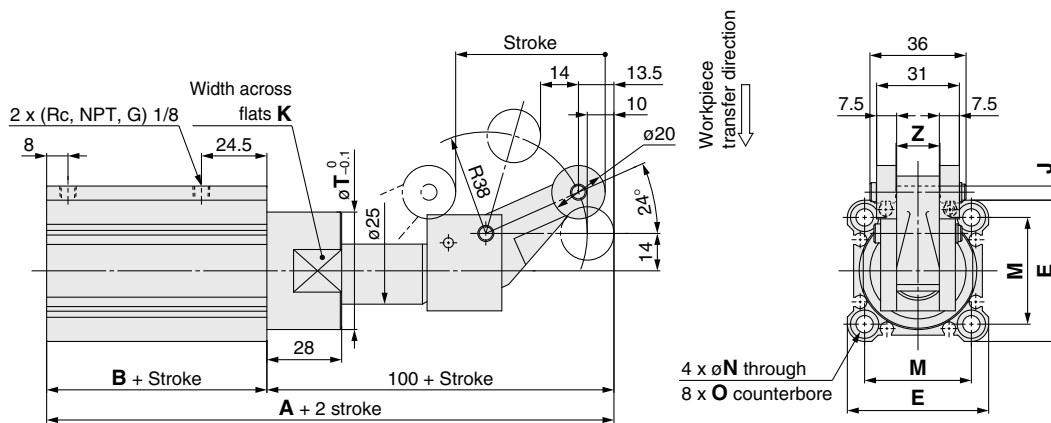

Mounting: **Both ends tapped**
RS□QA

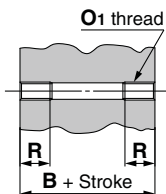

Bore size	B	O1	R
32	48	M6 x 1	10
40	52.5	M6 x 1	10
50	54	M8 x 1.25	14

* Dimensions other than those shown above are the same as the drawings above.

Refer to page 566 for dimensions of the model with built-in One-touch fittings.

Bore size	A	B	E	J	K	M	N	O	T	Z
40	152.5	52.5	52	5	41	40	5.5	9 depth 7	44	15
50	154	54	64	7	50	50	6.6	11 depth 8	56	19

- * Refer to pages 572 and 573 for the auto switch proper mounting position and mounting height.
- * For the single acting type, a One-touch fitting is on the rod end only.
- * The position of the width across flats (K) is arbitrary and is not specified.

RSQ

RSG

RS2H

RSH

**MIW
MIS**

D-□

-X□



These 3 figures show the piston rod extended.
The dimensions of the double acting type with spring loaded, and single acting/spring extend type are the same as those of the double acting type.

Dimensions

Rod end configuration: Lever (Adjustable absorber type), With lock mechanism
Mounting: Through-hole

Bore size: $\phi 32$ RS□QB32□-□DDZ (Double acting)

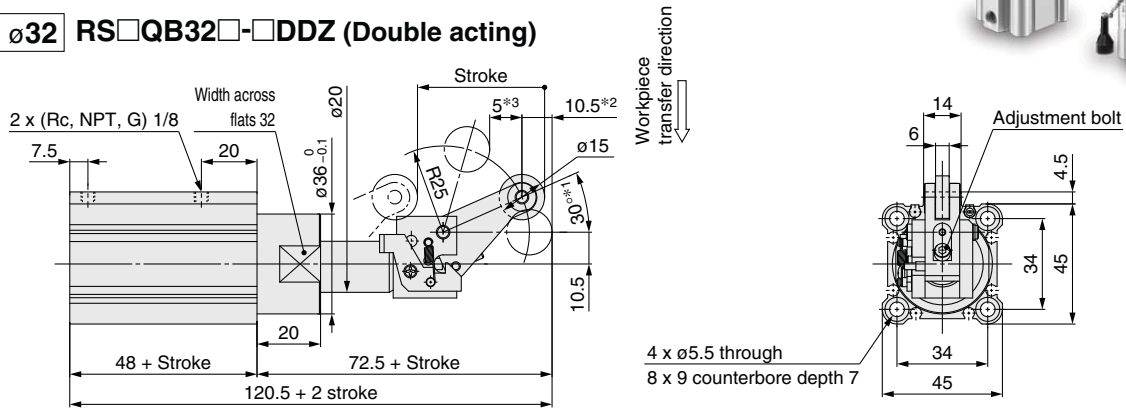

Bore size: $\phi 40, \phi 50$ RS□QB⁴⁰₅₀□-□DDZ (Double acting)

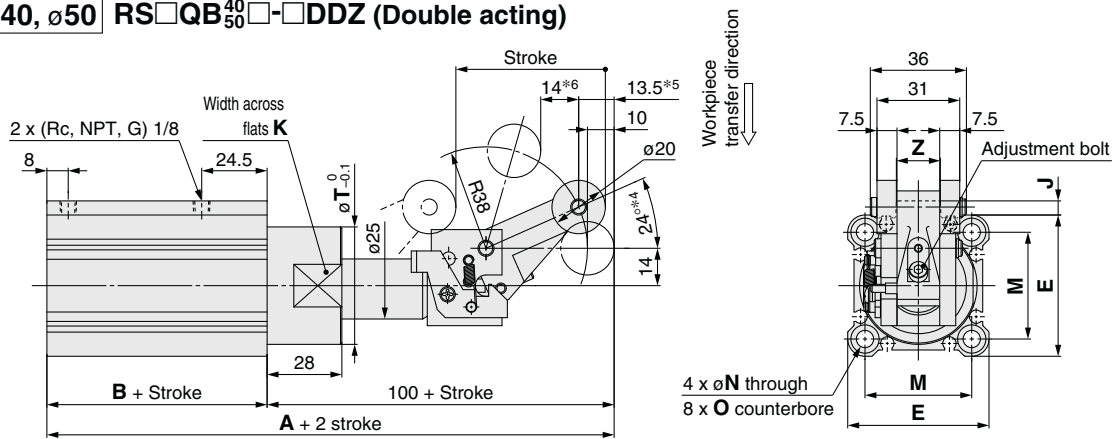

With lock mechanism + cancel cap RS□QB□□-□DEZ (Double acting)

* Dimensions are the same as the drawings above.

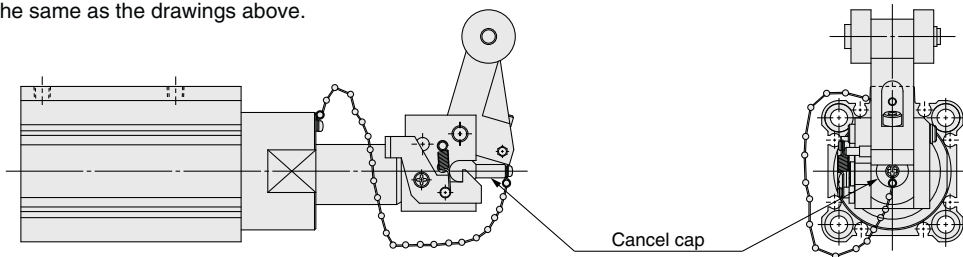

Mounting: Both ends tapped

RS□QA

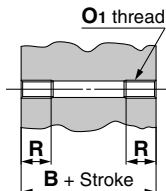

Bore size	B	O ₁	R
32	48	M6 x 1	10
40	52.5	M6 x 1	10
50	54	M8 x 1.25	14

* Dimensions other than those shown above are the same as the drawings above.

Bore size	A	B	E	J	K	M	N	O	T	Z
40	152.5	52.5	52	5	41	40	5.5	9 depth 7	44	15
50	154	54	64	7	50	50	6.6	11 depth 8	56	19

Refer to page 566 for dimensions of the model with built-in One-touch fittings.

- * Refer to pages 572 and 573 for the auto switch proper mounting position and mounting height.
- * For the single acting type, a One-touch fitting is on the rod end only.
- * The figures show the dimensions when the adjustment bolt is lowered (when energy absorption is at its maximum). However, these dimensions with asterisk change within the ranges shown below as the adjustment bolt is raised (energy absorption is reduced).
 $\phi 32 \dots 30^{\circ*1} \rightarrow 20^{\circ}, 10.5^{\circ*2} \rightarrow 9, 5^{\circ*3} \rightarrow 6$
 $\phi 40, 50 \dots 24^{\circ*4} \rightarrow 16^{\circ}, 13.5^{\circ*5} \rightarrow 11.5, 14^{\circ*6} \rightarrow 16$
- * The position of the width across flats (K) is arbitrary and is not specified.

RSQ

RSG

RS2H

RSH

MIW

MIS

D-□

-X□

RSQ Series Auto Switch Mounting

Auto Switch Proper Mounting Position (Detection at stroke end) and Mounting Height

D-M9□/M9□V
D-M9□W/M9□WV
D-M9□A/M9□AV
D-A9□/A9□V

∅12

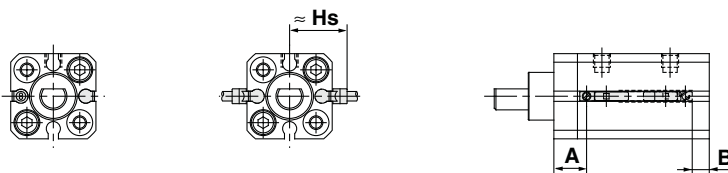

∅16, ∅20

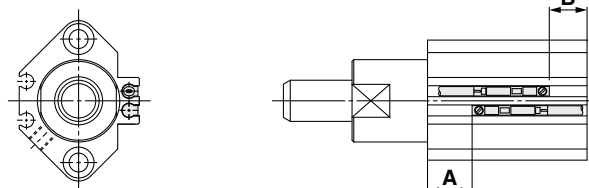

∅32 to ∅50

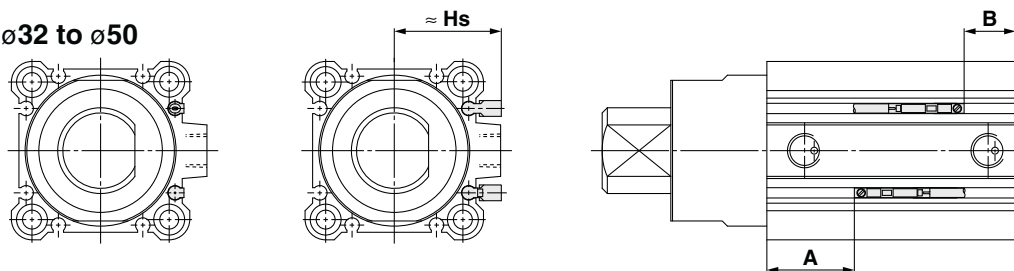

D-A7□
D-A80
D-A7□H
D-A80H
D-F7□
D-J79
D-F7□W
D-J79W
D-F79F
D-F7NT
D-F7BA
D-A73C
D-A80C
D-J79C
D-A79W
D-F7□WV
D-F7□V
D-F7BAV

∅16, ∅20

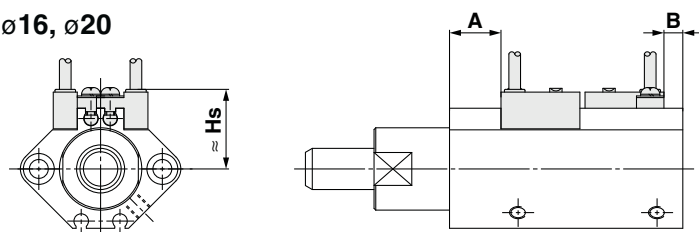

∅32 to ∅50

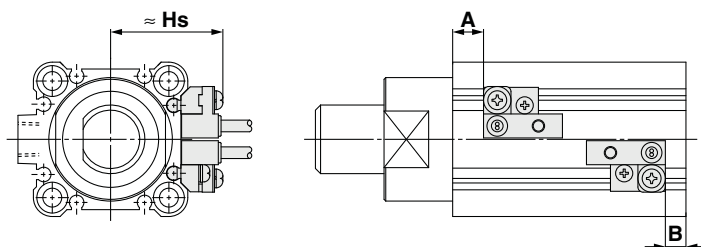

D-P3DWA

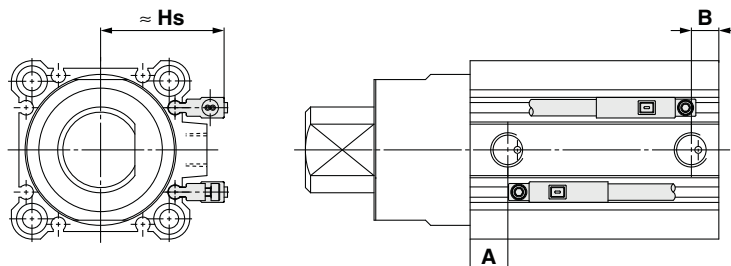

Auto Switch Proper Mounting Position (Detection at Stroke End) and Its Mounting Height

Auto Switch Proper Mounting Position

(mm)

Auto switch model Bore size (mm)	D-M9□ D-M9□V D-M9□W D-M9□WV D-M9□A D-M9□AV		D-A9□ D-A9□V		D-A73 D-A80		D-A72/A7□H/A80H D-A73C/A80C D-F7□/J79 D-F7□V/J79C D-F7BAV/F7BA D-F7□W/J79W D-F7□WV/F79F		D-F7NT		D-A79W		D-P3DWA	
	A	B	A	B	A	B	A	B	A	B	A	B	A	B
12	13	11	9	7	—	—	—	—	—	—	—	—	—	—
16	13	13	9	9	11.5	11.5	12	12	17	17	9	9	—	—
20	19	11	15	7	17.5	9.5	18	10	23	15	15	7	—	—
32	21	15	17	11	18	12	18.5	12.5	23.5	17.5	15.5	9.5	16.5	10.5
40	25.5	15	21.5	11	22.5	12	23	12.5	28	17.5	20	9.5	21	10.5
50	33.5	8.5	29.5	4.5	30.5	5.5	31	6	36	11	28	3	29	4

Note) Adjust the auto switch after confirming the operating conditions in the actual setting.

Auto Switch Mounting Height

(mm)

Auto switch model Bore size (mm)	D-M9□V D-M9□WV D-M9□AV		D-A9□V	D-A7□ D-A80	D-A7□H D-A80H/F7□ D-J79/F7□W D-F7BA D-J79W D-F79F D-F7NT	D-A73C D-A80C	D-F7□V D-F7□WV D-F7BAV	D-J79C	D-A79W	D-P3DWA
	Hs	Hs	Hs	Hs	Hs	Hs	Hs	Hs	Hs	Hs
12	19.5	17	—	—	—	—	—	—	—	—
16	22.5	20	22	22.5	28.5	24.5	27.5	25.5	—	
20	25	23	24.5	25.5	31	27.5	30	28	—	
32	30	27.5	34	36	40.5	36.5	39.5	37.5	35.5	
40	32	30	37.5	38	43.5	40	42.5	40.5	38	
50	37.5	35	43	43.5	49	45	48	46	43	

Operating Range

(mm)

Auto switch model	Bore size (mm)					
	12	16	20	32	40	50
D-M9□/M9□V D-M9□W/M9□WV D-M9□A/M9□AV	3	5	5.5	6	6	7
D-A9□/A9□V	6	9.5	9	9.5	9.5	9.5
D-A7□/A80 D-A7H/A80H D-A73C/A80C	—	12	12	12	11	10
D-A79W	—	13	13	13	14	14
D-F7□/J79 D-F7□V/J79C D-F7□W/J7□WV D-F7BA/F7BAV D-F79F/F7NT	—	6	5.5	6	6	6
D-P3DWA	—	—	—	5.5	5	6

* Since this is a guideline including hysteresis, not meant to be guaranteed. (Assuming approximately ±30% dispersion) There may be the case to change substantially depending on an ambient environment.

* The values above for a bore size ø12 and over ø32 of D-A9□(V)/M9□(V)/M9□W(V)/M9□A(V) types are measured when the current switch installation groove is attached without using the auto switch mounting bracket BQ2-012.

- RSQ
- RSG
- RS2H
- RSH
- MIW
- MIS

- D-□
- X□

Auto Switch Mounting Brackets/Parts Nos.

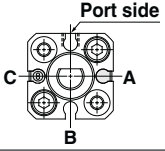
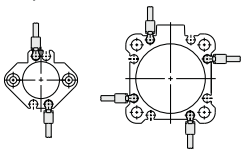
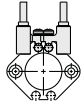
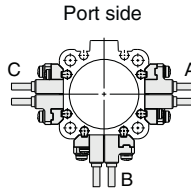
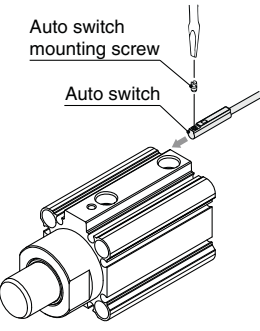
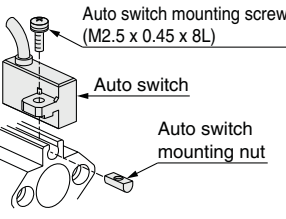
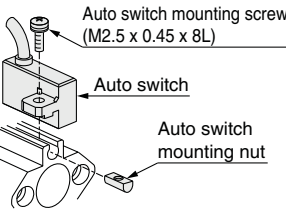
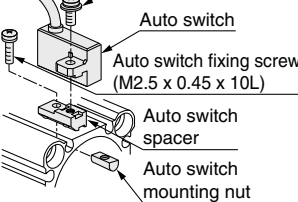
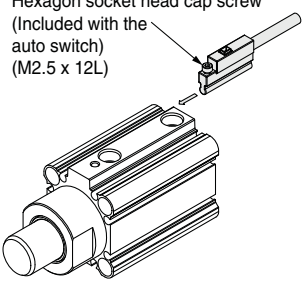
Applicable auto switch	D-M9□/M9□V D-M9□W/M9□WV D-M9□A/M9□AV D-A9□/A9□V	D-F7□/F7□V/J79/J79C/F7□W/J79W/F7□WV D-F7BA/F7BAV/F79F/F7NT D-A7□/A80/A7□H/A80H/A73C/A80C/A79W	D-P3DWA									
Bore size [mm]	ø12 to ø50	ø16, ø20	ø32 to ø50									
Auto switch mounting bracket part no.	—	BQ4-012	BQ5-032									
Auto switch mounting bracket fitting parts lineup/weight	—	• Auto switch mounting screw (M2.5 x 8L) • Auto switch mounting nut Weight: 1.5 g	• Auto switch fixing screw (M2.5 x 10L) • Auto switch mounting screw (M3 x 8L) • Auto switch spacer • Auto switch mounting nut Weight: 3.5 g									
Auto switch mounting surface	A/B/C side except port side (ø12) Surfaces with auto switch mounting slot ø12 Port side  ø16, ø20 ø32 to ø50 	Auto switch mounting rail side only 	A/B/C side except port side Surfaces with auto switch mounting slot Port side 									
Mounting of auto switch	 • When tightening the auto switch mounting screw, use a watchmaker's screwdriver with a handle diameter of 5 to 6 mm. Tightening Torque of Auto Switch Mounting Screw [N·m] <table border="1"> <thead> <tr> <th>Auto switch model</th> <th>Tightening torque</th> </tr> </thead> <tbody> <tr> <td>D-M9□(V) D-M9□W(V) D-A93</td> <td>0.05 to 0.15</td> </tr> <tr> <td>D-M9□A(V)</td> <td>0.05 to 0.10</td> </tr> <tr> <td>D-A9□(V) (Excludes the D-A93)</td> <td>0.10 to 0.20</td> </tr> </tbody> </table> 	Auto switch model	Tightening torque	D-M9□(V) D-M9□W(V) D-A93	0.05 to 0.15	D-M9□A(V)	0.05 to 0.10	D-A9□(V) (Excludes the D-A93)	0.10 to 0.20	<ol style="list-style-type: none"> Insert the nut into the auto switch mounting slot on the cylinder tube, and place it in the roughly estimated setting position. Engage the ridge on the auto switch mounting arm with the recess in the cylinder tube rail, and slide it to the position of the nut. Gently screw the auto switch mounting screw into the thread of the auto switch mounting nut through the mounting hole on the auto switch mounting arm. Confirm where the mounting position is, and tighten the auto switch mounting screw to fix the auto switch. The tightening torque of the M2.5 screw must be 0.25 to 0.35 N·m. The detecting position can be changed under the conditions in step ③. 	<ol style="list-style-type: none"> Insert the nut into the auto switch mounting slot on the cylinder tube, and place it in the roughly estimated setting position. With the lower tapered part of the auto switch spacer facing the outside of the cylinder tube, line up the M2.5 through hole with the M2.5 female of the auto switch mounting nut. Gently screw the auto switch mounting fixing screw (M2.5) into the thread of the auto switch mounting nut through the mounting hole. Engage the ridge on the auto switch mounting arm with the recess in the auto switch spacer. Tighten the auto switch mounting screw (M3) to fix the auto switch. The tightening torque of the M3 screw must be 0.35 to 0.45 N·m. Confirm where the mounting position is, and tighten the auto switch mounting nut. The tightening torque of the M2.5 screw must be 0.25 to 0.35 N·m. The detecting position can be changed under the conditions in step ⑤. Auto switch mounting screw (M3 x 0.5 x 8L) 	<ol style="list-style-type: none"> Insert the auto switch into the slot on the cylinder tube. Confirm where the detecting position is, and tighten the hexagon socket head cap screw (M2.5 x 12L) to fix the auto switch. If the detecting position is changed, go back to step ①. * Ensure that the auto switch is inserted into the auto switch mounting slot to protect the auto switch. * The tightening torque for the hexagon socket head cap screw (M2.5 x 12L) is 0.2 to 0.3 N·m. 
Auto switch model	Tightening torque											
D-M9□(V) D-M9□W(V) D-A93	0.05 to 0.15											
D-M9□A(V)	0.05 to 0.10											
D-A9□(V) (Excludes the D-A93)	0.10 to 0.20											

* Auto switch mounting bracket and auto switch are enclosed with the cylinder for shipment.
For an environment that needs the water-resistant auto switch, select the D-M9□A(V) type.
Auto switch mounting bracket for the D-F7BA(V) model uses BQ4-012 and BQ5-032 normal specifications (metal screw).

Auto Switch Mounting Brackets/Part Nos.

[Stainless Steel Mounting Screw]

The following stainless steel mounting screw kit (including nuts) is available. Use it in accordance with the operating environment. (Please order BQ-2 separately, since auto switch spacers (for BQ-2) are not included.)

BBA2: For D-A7/A8/F7/J7 models

The stainless steel screws above are used when a cylinder is shipped with the D-F7BA/F7BAV auto switches. When only one auto switch is shipped independently, the BBA2 is attached.

- * When mounting D-M9□A(V) on a port other than the ports for ø32, ø40, and ø50, order auto switch mounting brackets BQ2-012S, BQ-2, and stainless steel screw set BBA2 separately.
- * Refer to page 1051 for details on the BBA2.

Auto Switch Mounting Bracket Weight

Auto switch mounting bracket part no.	Weight [g]
BQ-1	1.5
BQ-2	1.5
BQ2-012	5

Other than the applicable auto switches listed in “How to Order,” the following auto switches are also mountable.

Other Applicable Auto Switches / Refer to pages 941 to 1067 for further information on auto switches.

Type	Model	Electrical entry	Features
Reed	D-A73	Grommet (Perpendicular)	—
	D-A80		Without indicator light
	D-A73H, A76H	Grommet (In-line)	—
	D-A80H		Without indicator light
Solid state	D-F7NV, F7PV, F7BV	Grommet (Perpendicular)	—
	D-F7NWV, F7BWV		Diagnostic indication (2-color indicator)
	D-F7BAV		Water-resistant (2-color indicator)
	D-F79, F7P, J79	Grommet (In-line)	—
	D-F79W, F7PW, J79W		Diagnostic indication (2-color indicator)
	D-F7BA		Water-resistant (2-color indicator)
	D-F7NT		With timer

- * With pre-wired connector is also available for solid state auto switches. For details, refer to pages 1014 and 1015.
- * Normally closed (NC = b contact) solid state auto switches (D-M9□E(V)) are also available. For details, refer to page 1592-1.

RSQ
RSG
RS2H
RSH
MIW
MIS

D-□
-X□