

Stainless Steel 316 Fittings

KFG2 Series

Compact and Light

RoHS

Dimensions **Approx. 44%** Shorter
* KFG2L0806-02

Weight **Approx. 37%** Lighter
* KFG2L0806-02

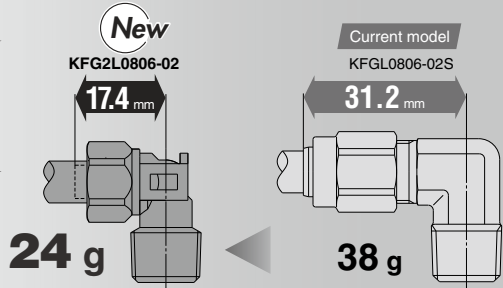

Material

Stainless steel 316

Rubber material is not used.
(Except swivel elbow)

Fluid temperature

-65 to 260°C
(Swivel elbow: -5 to 150°C)

Applicable tubing

Metric size, Inch size

Connection thread

R, Rc, NPT

- Grease-free/Can be used with steam.
- Certified to meet current Food Sanitation Law standards.
(Component materials have met apparatuses and container-packages standards.)

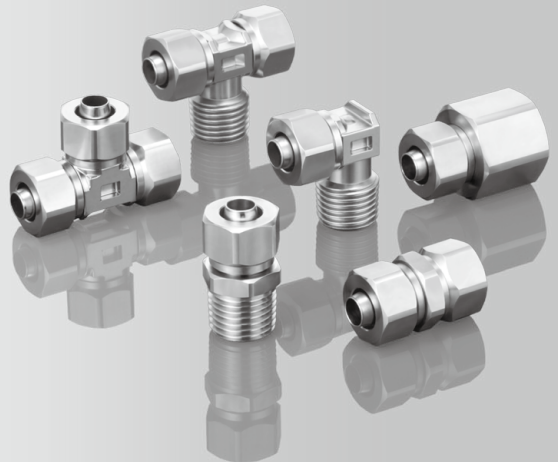

KQ2

KQB2

KS
KX

KM

KF

M

H/DL
L/LL

KC

KK

KK130

DM

KDM

KB

KR

KA

KQG2

KG

KFG2

MS

KKA

KP

LQ

MQR

T

IDK

Stainless Steel 316 Insert Fittings *KFG2 Series*

Compact and light

Dimensions: Approx. **44%** shorter

Weight: Approx. **37%** lighter

* Comparison with KFG L0806-02S

Material: Stainless steel 316

Rubber material is not used.

(Except swivel elbow)

Fluid temperature

-65 to 260°C

(Swivel elbow: -5 to 150°C)

Applicable tubing material

FEP • PFA • Modified PTFE

2-layer soft fluoropolymer

Nylon • Soft nylon • Polyolefin

Polyurethane* • Soft polyurethane*

Hard polyurethane*

Soft polyolefin*

Antistatic soft nylon*

Antistatic polyurethane*

Note) For tubes marked *, check the appropriate size.
(Pages 322, 328)

Grease-free

Can be used with steam.

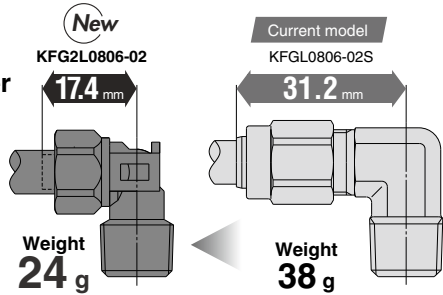

Sleeveless Sleeveless sealing structure makes replacement parts for maintenance unnecessary.

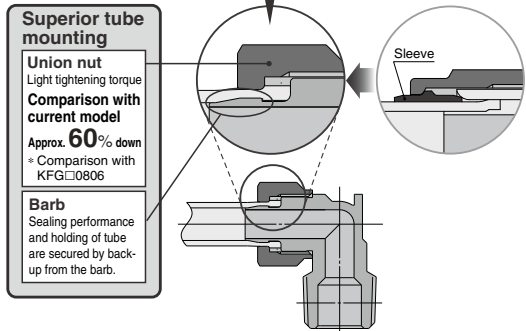

Applicable tubing	Connection thread	Page
Metric size	R, Rc	P.322 to 326
Inch size	NPT	P.328 to 331

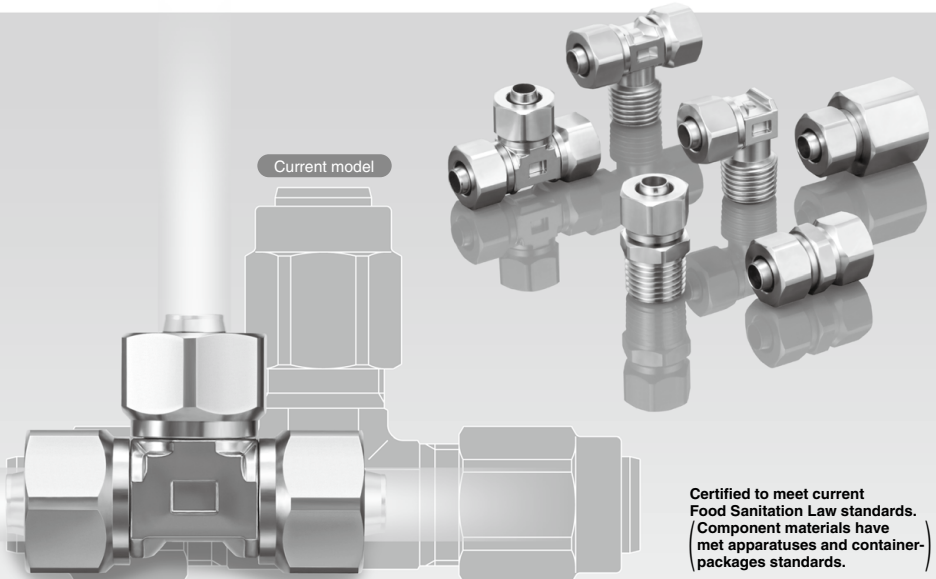

Certified to meet current Food Sanitation Law standards.
(Component materials have met apparatuses and container-packages standards.)

Variations

Male Connector

KFG2H

 Metric P. 323
 Inch P. 329

Bulkhead Union

KFG2E

 Metric P. 325
 Inch P. 330

Male Elbow

KFG2L

 Metric P. 323
 Inch P. 329

Union Elbow

KFG2L

 Metric P. 325
 Inch P. 330

Male Branch Tee

KFG2T

 Metric P. 324
 Inch P. 329

Swivel Elbow

KFG2V

 Metric P. 325
 Inch P. 331

Straight Union

KFG2H

 Metric P. 324
 Inch P. 330

Female Connector

KFG2F

 Metric P. 326
 Inch P. 331

Union Tee

KFG2T

 Metric P. 324
 Inch P. 330

Union Nut

KFG2N

 Metric P. 326
 Inch P. 331

KQ2
KQB2
KS
KX
KM
KF
M
H/DL
L/LL
KC
KK
KK130
DM
KDM
KB
KR
KA
KQG2
KG
KFG2
MS
KKA
KP
LQ
MQR
T
IDK

Stainless Steel 316 Insert Fittings

Applicable Tubing: Metric Size, Connection Thread: R, Rc

KFG2 Series

RoHS



Applicable Tubing

Tubing material (Note)	FEP, PFA, Modified PTFE, 2-layer soft fluoropolymer, Nylon, Soft nylon, Polyurethane, Soft polyurethane, Polyolefin, Soft polyolefin, Antistatic soft nylon, Antistatic polyurethane, Hard polyurethane, Wear resistant polyurethane
Tubing size	ø4 x ø2.5, ø4 x ø3, ø6 x ø4, ø8 x ø6, ø10 x ø7.5 ø10 x ø8, ø12 x ø9, ø12 x ø10, ø16 x ø13

(Note) For soft polyurethane tubing, hard polyurethane tubing, antistatic polyurethane tubing, water cannot be used.

Series	Tubing material	Tubing O.D. x I.D. (mm)								
		ø4 x ø2.5	ø4 x ø3	ø6 x ø4	ø8 x ø6	ø10 x ø7.5	ø10 x ø8	ø12 x ø9	ø12 x ø10	ø16 x ø13
TH	FEP	●	—	●	●	●	●	●	●	—
TL	Super PFA	—	●	●	●	—	●	—	●	—
TLM	PFA	●	—	●	●	—	●	—	●	—
TD	Modified PTFE	●	—	●	●	—	●	—	—	—
TQ	Special fluoropolymer	●	—	●	●	—	●	—	—	—
T	Nylon	●	●	●	●	●	—	●	—	●
TS	Soft nylon	●	—	●	●	—	●	—	●	—
TU	Polyurethane	●	—	●	—	—	—	—	—	—
TPH	Polyolefin	●	—	●	●	—	●	—	—	—
TUS	Soft polyurethane	●	—	●	—	—	—	—	—	—
TUH	Hard polyurethane (High pressure)	●	—	—	—	—	—	—	—	—
TPS	Soft polyolefin	●	—	●	—	—	—	—	—	—
TAS	Antistatic soft nylon	●	—	●	—	—	—	—	—	—
TAU	Antistatic polyurethane	●	—	—	—	—	—	—	—	—
TUZ	Wear resistant polyurethane	●	—	●	—	—	—	—	—	—

Spare Parts

Description	Tubing O.D.	Part no.	Material
Bulkhead nut	ø4	KFG204-P01	Stainless steel 316
	ø6	KFG206-P01	
	ø8	KFG208-P01	
	ø10	KFG210-P01	
	ø12	KFG212-P01	
	ø16	KFG216-P01	

Specifications

Fluid	Air, N ₂ , Water, Steam, Turbine oil class 1 (ISO VG32) (Note 2) (Note 3)
Operating pressure range (Note 1)	–100 kPa to 1 MPa (Note 4)
Proof pressure	3.0 MPa
Ambient and fluid temperature	–65 to 260°C (No freezing) (Note 4) [Swivel elbow and with sealant types: –5 to 150°C]
Lubricant	Grease-free specification
Seal on the threads	Without sealant (With sealant type compatible) (Note 5)

Note 1) Avoid using in a vacuum holding application such as a leak tester, since there is leakage.

Note 2) Consult with SMC regarding applicable tubing separately.

Note 3) Using special FKM that is resistant even when steam is used.

Note 4) Check the operating pressure range and operating temperature range of the tube.

Note 5) With sealant: Suffix "S" to the end of part number.

Note 6) Union nut is shipped together.

Construction

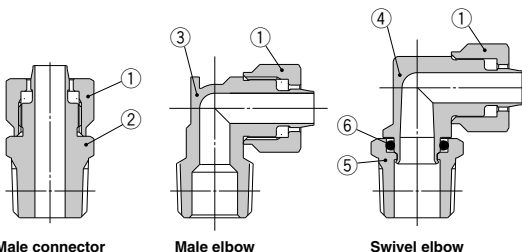

Male connector

Male elbow

Swivel elbow

Principal Parts Material

No.	Description	Material	Note
1	Union nut	Stainless steel 316	Fluoro coated
2	Male connector body	Stainless steel 316	
3	Male elbow body	Stainless steel 316	
4	Swivel elbow body	Stainless steel 316	
5	Stud	Stainless steel 316	
6	O-ring	Special FKM	Fluoro coated

Dimensions

Male Connector: KFG2H



Applicable tubing size (mm)		Connection thread R	Model	Width across flat		L	M	ød	A*	Effective area (mm ²)	Weight (g)
O.D.	I.D.			H1	H2						
ø4	ø2.5	1/8	KFG2H0425-01	10	8	19.4	5	1.8	16.3	1.6	8
		1/4	KFG2H0425-02	14		23.8					14
ø4	ø3	1/8	KFG2H0403-01	10	8	19.4	5	2.3	16.3	2.6	8
		1/4	KFG2H0403-02	14		23.8					14
ø6	ø4	1/8	KFG2H0604-01	10	10	20.9	5.8	3.3	17.8	6	10
		1/4	KFG2H0604-02	14		25.3					16
ø8	ø6	1/8	KFG2H0806-01	14	14	23.3	6.6	5.3	20.2	17	18
		1/4	KFG2H0806-02			26.7					24
		3/8	KFG2H0806-03			28.1					36
ø10	ø7.5	1/4	KFG2H1075-02	17	17	29.7	7.6	6.8	25	30	34
		3/8	KFG2H1075-03			30.1					41
		1/2	KFG2H1075-04			33.5					67
ø10	ø8	1/4	KFG2H1008-02	17	17	29.7	7.3	9	25	35	33
		3/8	KFG2H1008-03			30.1					40
		1/2	KFG2H1008-04			33.5					66
ø12	ø9	1/4	KFG2H1209-02	17	17	31.3	8.5	8	26.6	45	33
		3/8	KFG2H1209-03			31.7					40
		1/2	KFG2H1209-04			35.1					66
ø12	ø10	1/4	KFG2H1210-02	17	17	31.3	9	9	26.6	57	30
		3/8	KFG2H1210-03			31.7					38
		1/2	KFG2H1210-04			35.1					63
ø16	ø13	3/8	KFG2H1613-03	22	22	33.1	9.3	12	28	101	51
		1/2	KFG2H1613-04			36.3					67

* Reference dimensions after installation of R thread

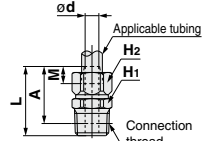

Male Elbow: KFG2L



Applicable tubing size (mm)		Connection thread R	Model	Width across flat		L1	L2	M	ød	A*	Effective area (mm ²)	Weight (g)
O.D.	I.D.			H1	H2							
ø4	ø2.5	1/8	KFG2L0425-01	10	8	12.5	13.5	5	1.8	13.8	1.6	10
		1/4	KFG2L0425-02			15.9						14
ø4	ø3	1/8	KFG2L0403-01	10	8	12.5	13.5	5	2.3	13.8	2.6	10
		1/4	KFG2L0403-02			15.9						14
ø6	ø4	1/8	KFG2L0604-01	10	10	13.6	15	5.8	3.3	16	6	12
		1/4	KFG2L0604-02			17						16
ø8	ø6	1/8	KFG2L0806-01	12	14	15.8	17.4	6.6	5.3	20.4	12	20
		1/4	KFG2L0806-02			19.2						24
		3/8	KFG2L0806-03			19.6						27
ø10	ø7.5	1/4	KFG2L1075-02	15	17	20.9	20.9	7.6	6.8	25.6	23	38
		3/8	KFG2L1075-03			21.3						41
		1/2	KFG2L1075-04			24.5						51
ø10	ø8	1/4	KFG2L1008-02	15	17	20.9	20.9	7.6	7.3	25.6	27	37
		3/8	KFG2L1008-03			21.3						41
		1/2	KFG2L1008-04			24.5						50
ø12	ø9	1/4	KFG2L1209-02	16	17	20.9	23.5	8.5	8	25.6	27	41
		3/8	KFG2L1209-03			21.3						45
		1/2	KFG2L1209-04			24.5						57
ø12	ø10	1/4	KFG2L1210-02	16	17	20.9	23.5	8.5	9	25.6	34	42
		3/8	KFG2L1210-03			21.3						43
		1/2	KFG2L1210-04			24.5						53
ø16	ø13	3/8	KFG2L1613-03	21	22	24	26.2	9.3	12	31	79	72
		1/2	KFG2L1613-04			27.2						78

* Reference dimensions after installation of R thread

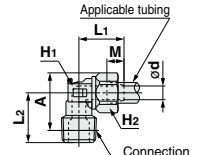

- KQ2
- KQB2
- KS
- KX
- KM
- KF
- M
- H/DL
- L/LL
- KC
- KK
- KK130
- DM
- KDM
- KB
- KR
- KA
- KQG2
- KG
- KFG2
- MS
- KKA
- KP
- LQ
- MQR
- T
- IDK

KFG2 Series

Applicable Tubing: Metric Size, Connection Thread: R, Rc

Dimensions

Male Branch Tee: KFG2T



Applicable tubing size (mm)		Connection thread R	Model	Width across flat		L1	L2	M	ød	A*	Effective area (mm ²)	Weight (g)
O.D.	I.D.			H1	H2							
ø4	ø2.5	1/8	KFG2T0425-01	10	8	13.5	12.5	5	1.8	13.8	3	13
		1/4	KFG2T0425-02									
ø4	ø3	1/8	KFG2T0403-01	10	8	13.5	12.5	5	2.3	13.8	5	12
		1/4	KFG2T0403-02									
ø6	ø4	1/8	KFG2T0604-01	10	10	15	14.7	5.8	3.3	17.1	10	17
		1/4	KFG2T0604-02									
ø8	ø6	1/8	KFG2T0806-01	12	14	17.4	15.8	6.6	5.3	20.4	16	30
		1/4	KFG2T0806-02									
ø10	ø7.5	3/8	KFG2T0806-03	12	14	17.4	19.6	6.6	5.3	22.2	25	34
		1/2	KFG2T0806-04									
ø10	ø8	1/4	KFG2T1075-02	15	17	20.9	20.9	7.6	6.8	25.6	30	55
		3/8	KFG2T1075-03									
ø10	ø8	1/2	KFG2T1075-04	15	17	20.9	24.5	7.6	6.8	27.5	41	68
		3/8	KFG2T1008-03									
ø12	ø9	1/4	KFG2T1210-02	16	17	23.5	20.9	8.5	8	25.6	48	73
		3/8	KFG2T1210-03									
ø12	ø10	1/2	KFG2T1210-04	16	17	23.5	24.5	8.5	8	27.5	61	98
		3/8	KFG2T1210-03									
ø16	ø13	1/2	KFG2T1613-03	21	22	26.2	24	9.3	12	31	108	98
		3/8	KFG2T1613-04									

* Reference dimensions after installation of R thread

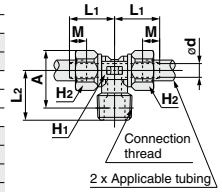

Straight Union: KFG2H



Applicable tubing size (mm)		Model	Width across flat		L	M	ød	Effective area (mm ²)	Weight (g)
O.D.	I.D.		H1	H2					
ø4	ø2.5	KFG2H0425-00	8	8	21.8	5	1.8	1.6	7
		ø3							
ø6	ø4	KFG2H0604-00	10	10	24.8	5.8	3.3	6	11
		ø6							
ø8	ø6	KFG2H0806-00	14	14	28.6	6.6	5.3	17	25
		ø7.5							
ø10	ø8	KFG2H1008-00	17	17	33.6	7.6	7.3	35	42
		ø8							
ø12	ø9	KFG2H1209-00	17	17	37	8.5	8	45	44
		ø10							
ø16	ø13	KFG2H1613-00	22	22	39.4	9.3	12	101	71
		ø13							

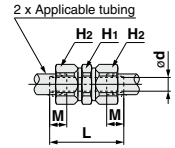

Union Tee: KFG2T



Applicable tubing size (mm)		Model	Width across flat		L	M	ød	Effective area (mm ²)	Weight (g)
O.D.	I.D.		H1	H2					
ø4	ø2.5	KFG2T0425-00	7	8	13.3	5	1.8	1.6	11
		ø3							
ø6	ø4	KFG2T0604-00	9	10	15.8	5.8	3.3	6	18
		ø6							
ø8	ø6	KFG2T0806-00	12	14	18.7	6.6	5.3	17	39
		ø7.5							
ø10	ø8	KFG2T1008-00	15	17	22.2	7.6	7.3	35	67
		ø8							
ø12	ø9	KFG2T1209-00	16	17	24.3	8.5	8	45	71
		ø10							
ø16	ø13	KFG2T1613-00	21	22	28	9.3	12	101	122
		ø13							

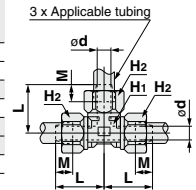

Stainless Steel 316 Insert Fittings **KFG2 Series**

Applicable Tubing: Metric Size, Connection Thread: R, Rc

Dimensions

Bulkhead Union: KFG2E



Applicable tubing size (mm)		Model	Width across flat			L ₁	L ₂	M	ød	Mounting hole	Effective area (mm ²)	Weight (g)
O.D.	I.D.		H ₁	H ₂	H ₃							
ø4	ø2.5	KFG2E0425-00	12	8	12	32.6	29	5	1.8	11	1.6	16
ø4	ø3	KFG2E0403-00							2.3		2.6	
ø6	ø4	KFG2E0604-00	14	10	14	36.6	32.2	5.8	3.3	13	6	25
ø8	ø6	KFG2E0806-00	17	14	17	40.4	35.8	6.6	5.3	15	17	43
ø10	ø7.5	KFG2E1075-00							6.8		30	69
ø10	ø8	KFG2E1008-00	21	17	21	44.8	39.4	7.6	7.3	18	35	68
ø12	ø9	KFG2E1209-00							8		45	71
ø12	ø10	KFG2E1210-00	21	17	21	48.1	41.7	8.5	9	19	57	68
ø16	ø13	KFG2E1613-00	27	22	27	52.3	45.9	9.3	12	25	101	122

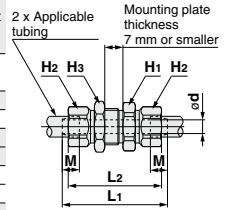

Union Elbow: KFG2L



Applicable tubing size (mm)		Model	Width across flat		L	M	ød	Effective area (mm ²)	Weight (g)
O.D.	I.D.		H ₁	H ₂					
ø4	ø2.5	KFG2L0425-00	7	8	13.3	5	1.8	1.6	8
ø4	ø3	KFG2L0403-00					2.3	2.6	
ø6	ø4	KFG2L0604-00	9	10	15.8	5.8	3.3	6	13
ø8	ø6	KFG2L0806-00	12	14	18.7	6.6	5.3	17	28
ø10	ø7.5	KFG2L1075-00					6.8	30	47
ø10	ø8	KFG2L1008-00	15	17	22.2	7.6	7.3	35	46
ø12	ø9	KFG2L1209-00					8	45	51
ø12	ø10	KFG2L1210-00	16	17	24.3	8.5	9	57	48
ø16	ø13	KFG2L1613-00	21	22	28	9.3	12	101	89

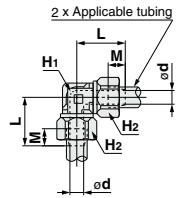

Swivel Elbow: KFG2V



Applicable tubing size (mm)		Connection thread R	Model	Width across flat			L ₁	L ₂	M	ød	A*	Effective area (mm ²)	Weight (g)
O.D.	I.D.			H ₁	H ₂	H ₃							
ø4	ø2.5	1/8	KFG2V0425-01	7	8	10	16.1	5	1.8	17.4	1.4	9	
						14	19.9						18
ø4	ø3	1/8	KFG2V0403-01	9	10	10	16.1	5.8	2.3	17.4	2.3	9	
						14	19.9						18
ø6	ø4	1/8	KFG2V0604-01	9	10	10	17.2	6.6	3.3	19.6	5	12	
						14	21						21
ø6	ø6	1/8	KFG2V0806-01	12	14	12	20.1	6.6	5.3	24.7	14	22	
						14	18.4						23.3
ø6	ø6	3/8	KFG2V0806-03	12	14	17	24.7	6.6	5.3	27.3	14	42	
						14	25						29.6
ø10	ø7.5	1/4	KFG2V1075-02	15	17	14	25	7.6	6.8	30.6	25	37	
						17	26.4						37
ø10	ø7.5	1/2	KFG2V1075-04	15	17	22	30.6	7.6	6.8	33.5	25	74	
						14	25						29.6
ø10	ø8	1/4	KFG2V1008-02	15	17	14	25	7.6	7.3	30.6	29	46	
						17	26.4						33.5
ø10	ø8	1/2	KFG2V1008-04	15	17	22	30.6	7.6	7.3	30.6	29	73	
						14	25						29.6
ø12	ø9	1/4	KFG2V1209-02	16	17	14	25	8.5	8	29.6	38	38	
						17	23						26.4
ø12	ø9	3/8	KFG2V1209-03	16	17	22	30.6	8.5	8	30.6	38	49	
						14	25						29.6
ø12	ø10	1/2	KFG2V1209-04	16	17	22	30.6	8.5	8	33.5	38	75	
						14	25						29.6
ø12	ø10	3/8	KFG2V1210-03	16	17	14	25	8.5	9	30.6	48	51	
						17	24.5						26.4
ø12	ø10	1/2	KFG2V1210-04	16	17	22	30.6	8.5	9	33.5	48	77	
						14	25						29.6
ø16	ø13	3/8	KFG2V1613-03	21	22	19	29.3	9.3	12	36.3	86	75	
						22	26.7						33.3
ø16	ø13	1/2	KFG2V1613-04	21	22	22	33.3	9.3	12	39	86	96	
						14	25						29.6

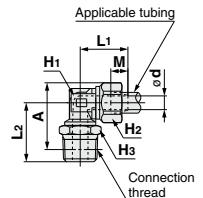

* Reference dimensions after installation of R thread

KQ2

KQB2

KS

KX

KM

KF

M

H/DL

L/LL

KC

KK

KK130

DM

KDM

KB

KR

KA

KQG2

KG

KFG2

MS

KKA

KP

LQ

MQR

T

IDK

KFG2 Series

Applicable Tubing: Metric Size, Connection Thread: R, Rc

Dimensions

Female Connector: KFG2F



Applicable tubing size (mm)		Connection thread Rc	Model	Width across flat		L1	L2	M	ød	Effective area (mm ²)	Weight (g)
O.D.	I.D.			H1	H2						
ø4	ø2.5	1/4	KFG2F0425-02	17	8	25.9	16.4	5	1.8	1.6	24
ø4	ø3	1/4	KFG2F0403-02						2.3	2.6	
ø6	ø4	1/4	KFG2F0604-02	17	10	26.8	15.8	5.8	3.3	6	25
ø8	ø6	3/8	KFG2F0806-03	19	14	28.8	16.4	6.6	5.3	17	31
ø10	ø7.5	3/8	KFG2F1075-03	19	17	30	15.6	7.6	6.8	30	36
ø10	ø8	3/8	KFG2F1008-03						7.3	35	
ø12	ø9	3/8	KFG2F1209-03	19	17	31.2	15.2	8.5	8	45	36
ø12	ø10	3/8	KFG2F1210-03						9	57	
ø16	ø13	1/2	KFG2F1613-04	24	22	37.7	20.5	9.3	12	101	71

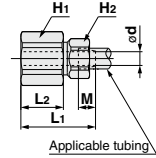

Union Nut: KFG2N



Applicable tubing O.D. (mm)	Model	H (Width across flat)	L	Weight (g)
ø4	KFG2N-04	8	7.7	1.9
ø6	KFG2N-06	10	8.8	3
ø8	KFG2N-08	14	10.1	6.7
ø10	KFG2N-10	17	11.7	10.5
ø12	KFG2N-12	17	12.8	9.6
ø16	KFG2N-16	22	14	15.3

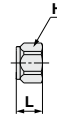

KQ2
KQB2
KS KX
KM
KF
M
H/DL L/LL
KC
KK
KK130
DM
KDM
KB
KR
KA
KQG2
KG
KFG2
MS
KKA
KP
LQ
MQR
T
IDK

Stainless Steel 316 Insert Fittings

Applicable Tubing: Inch Size, Connection Thread: NPT

KFG2 Series

RoHS



Applicable Tubing

Tubing material ^{Note 1)}	FEP, PFA, Modified PTFE, Nylon, Soft nylon, Polyurethane, Soft polyurethane, Polyolefin, Soft polyolefin, Antistatic soft nylon, Antistatic polyurethane, Hard polyurethane, Wear resistant polyurethane
Tubing size	ø1/8" x ø0.086", ø5/32" x 0.098", ø1/4" x ø5/32" ø5/16" x 0.236", ø3/8" x ø1/4", ø1/2" x ø3/8"

Note) For soft polyurethane tubing, hard polyurethane tubing, antistatic polyurethane tubing, water cannot be used.

Series	Tubing material	Tubing O.D. x I.D. (inch)					
		ø1/8" x ø0.086" (ø3.18 x ø2.18)	ø5/32" x ø1.098" (ø4 x ø2.5)	ø1/4" x ø5/32" (ø6.35 x ø3.95)	ø5/16" x ø0.236" (ø8 x ø6)	ø3/8" x ø1/4" (ø9.53 x ø6.35)	ø1/2" x ø3/8" (ø12.7 x ø9.53)
TH/THI	FEP	●	●	●	●	●	●
TL/TIL	Super PFA	●	—	●	●	●	●
TLM/TILM	PFA	●	●	●	●	●	●
TD/TID	Modified PTFE	●	●	●	●	●	●
T/TIA	Nylon	●	●	—	●	—	●
TS/TISA	Soft nylon	●	●	—	●	—	●
TU/TIUB	Polyurethane	—	●	—	—	●	—
TPH	Polyolefin	—	●	—	●	—	—
TUS	Soft polyurethane	—	●	—	—	—	—
TUH	Hard polyurethane (High pressure)	—	●	—	—	—	—
TPS	Soft polyolefin	—	●	—	—	—	—
TAS	Antistatic soft nylon	—	●	—	—	—	—
TAU	Antistatic polyurethane	—	●	—	—	—	—
TUZ	Wear resistant polyurethane	—	●	—	●	—	—

Spare Parts

Description	Tubing O.D.	Part no.	Material
Bulkhead nut	ø1/8"	KFG201-P01	Stainless steel 316
	ø5/32"	KFG203-P01	
	ø1/4"	KFG207-P01	
	ø5/16"	KFG209-P01	
	ø3/8"	KFG211-P01	
	ø1/2"	KFG213-P01	

Specifications

Fluid	Air, N ₂ , Water, Steam ^{Note 2)} ^{Note 3)}
Operating pressure range ^{Note 1)}	–100 kPa to 1 MPa ^{Note 4)}
Proof pressure	3.0 MPa
Ambient and fluid temperature	–65 to 260°C (No freezing) ^{Note 4)} [Swivel elbow and with sealant types: –5 to 150°C]
Lubricant	Grease-free specification
Seal on the threads	Without sealant (With sealant type compatible) ^{Note 5)}

Note 1) Avoid using in a vacuum holding application such as a leak tester, since there is leakage.

Note 2) Consult with SMC regarding applicable tubing separately.

Note 3) Using special FKM that is resistant even when steam is used.

Note 4) Check the operating pressure range and operating temperature range of the tube.

Note 5) With sealant: Suffix "S" to the end of part number.

Note 6) Union nut is shipped together.

Construction

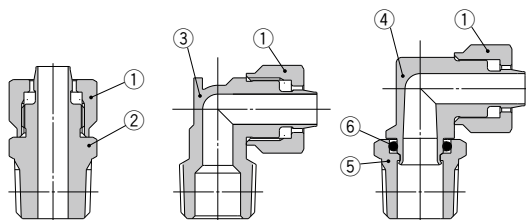

Male connector

Male elbow

Swivel elbow

328



Principal Parts Material

No.	Description	Material	Note
1	Union nut	Stainless steel 316	Fluoro coated
2	Male connector body	Stainless steel 316	
3	Male elbow body	Stainless steel 316	
4	Swivel elbow body	Stainless steel 316	
5	Stud	Stainless steel 316	
6	O-ring	Special FKM	Fluoro coated

Dimensions

Male Connector: KFG2H



Applicable tubing size (inch)		Connection thread NPT	Model	Width across flat		L	M	ød	A*	Effective area (mm ²)	Weight (g)
O.D.	I.D.			H ₁	H ₂						
ø1/8" (ø3.18)	ø0.086" (ø2.18)	1/8	KFG2H0122-N01	12	8	19.4	5	1.5	16.2	1.1	9
		1/4	KFG2H0122-N02	14	8	23.8			19.4		15
ø5/32" (ø4)	ø0.098" (ø2.5)	1/8	KFG2H0325-N01	12	8	19.4	5	1.8	16.2	1.6	9
		1/4	KFG2H0325-N02	14	8	23.8			19.4		15
ø1/4" (ø6.35)	ø5/32" (ø3.95)	1/8	KFG2H0704-N01	12	12	21.1	6	3.3	17.9	13	19
		1/4	KFG2H0704-N02	14	12	25.5			21.1	6	19
ø5/16" (ø8)	ø0.236" (ø6)	1/8	KFG2H0906-N01	14		23.3			20.1		18
		1/4	KFG2H0906-N02	14	14	26.7	6.6	5.3	22.3	17	25
		3/8	KFG2H0906-N03	19		28.3			23.6		40
ø3/8" (ø9.53)	ø1/4" (ø6.35)	1/4	KFG2H1163-N01	17		29.7			25.3		37
		3/8	KFG2H1163-N03	19	17	30.3	7.6	5.6	25.6	19	47
ø1/2" (ø12.7)	ø3/8" (ø9.53)	1/2	KFG2H1163-N04	22		33.5			27.1		70
		1/4	KFG2H1395-N02	19		31.5			27.1		40
		3/8	KFG2H1395-N03	19	19	31.9	8.5	8.5	27.2	40.1	78
		1/2	KFG2H1395-N04	22		35.1			28.7		40

* Reference dimensions after installation of NPT thread

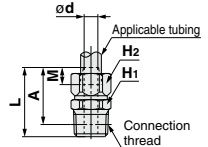

Male Elbow: KFG2L



Applicable tubing size (inch)		Connection thread NPT	Model	Width across flat		L ₁	L ₂	M	ød	A*	Effective area (mm ²)	Weight (g)
O.D.	I.D.			H ₁	H ₂							
ø1/8" (ø3.18)	ø0.086" (ø2.18)	1/8	KFG2L0122-N01	10	8	13.5	12.5	5	1.5	13.7	1.1	10
		1/4	KFG2L0122-N02	10	8	13.5	15.9			15.9		15
ø5/32" (ø4)	ø0.098" (ø2.5)	1/8	KFG2L0325-N01	10	8	13.5	12.5	5	1.8	13.7	1.6	10
		1/4	KFG2L0325-N02	10	8	13.5	15.9			15.9		15
ø1/4" (ø6.35)	ø5/32" (ø3.95)	1/8	KFG2L0704-N01	10	12	15.2	14.7	6	3.3	18.1	6	15
		1/4	KFG2L0704-N02	10	12	15.2	18.1			20.3		19
ø5/16" (ø8)	ø0.236" (ø6)	1/8	KFG2L0906-N01				15.8			20.3	12	20
		1/4	KFG2L0906-N02	12	14	17.4	19.2	6.6	5.3	22.5	16	25
		3/8	KFG2L0906-N03				19.6			22.6		28
ø3/8" (ø9.53)	ø1/4" (ø6.35)	1/4	KFG2L1163-N02				20.9			25.9	13	39
		3/8	KFG2L1163-N03	15	17	20.4	21.3	7.6	5.6	26.0	18	42
		1/2	KFG2L1163-N04				24.5			27.5		52
ø1/2" (ø12.7)	ø3/8" (ø9.53)	1/4	KFG2L1395-N02				21.9			27.9	30	48
		3/8	KFG2L1395-N03	17	19	23.3	22.3	8.5	8.5	28	40	51
		1/2	KFG2L1395-N04				25.5			29.5		61

* Reference dimensions after installation of NPT thread

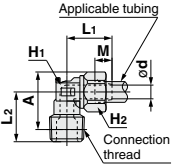

Male Branch Tee: KFG2T



Applicable tubing size (inch)		Connection thread NPT	Model	Width across flat		L ₁	L ₂	M	ød	A*	Effective area (mm ²)	Weight (g)
O.D.	I.D.			H ₁	H ₂							
ø1/8" (ø3.18)	ø0.086" (ø2.18)	1/8	KFG2T0122-N01	10	8	13.5	12.5	5	1.5	13.7	2	13
		1/4	KFG2T0122-N02	10	8	13.5	15.9			15.9		17
ø5/32" (ø4)	ø0.098" (ø2.5)	1/8	KFG2T0325-N01	10	8	13.5	12.5	5	1.8	13.7	3	13
		1/4	KFG2T0325-N02	10	8	13.5	15.9			15.9		17
ø1/4" (ø6.35)	ø5/32" (ø3.95)	1/8	KFG2T0704-N01	10	12	15.2	14.7	6	3.3	18.1	10	22
		1/4	KFG2T0704-N02	10	12	15.2	18.1			20.3		26
ø5/16" (ø8)	ø0.236" (ø6)	1/8	KFG2T0906-N01				15.8			20.3	16	31
		1/4	KFG2T0906-N02	12	14	17.4	19.2	6.6	5.3	22.5	35	35
		3/8	KFG2T0906-N03				19.6			22.6	25	38
ø3/8" (ø9.53)	ø1/4" (ø6.35)	1/4	KFG2T1163-N02				20.9			25.9	18	58
		3/8	KFG2T1163-N03	15	17	20.4	21.3	7.6	5.6	26.0	28	61
		1/2	KFG2T1163-N04				24.5			27.5		71
ø1/2" (ø12.7)	ø3/8" (ø9.53)	1/4	KFG2T1395-N02				21.9			27.9	36	70
		3/8	KFG2T1395-N03	17	19	23.3	22.3	8.5	8.5	28	54	74
		1/2	KFG2T1395-N04				25.5			29.5		83

* Reference dimensions after installation of NPT thread

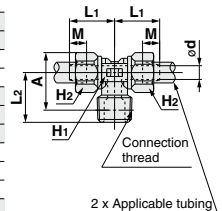

- KQ2
- KQB2
- KS
- KX
- KM
- KF
- M
- H/DL
- L/LL
- KC
- KK
- KK130
- DM
- KDM
- KB
- KR
- KA
- KQG2
- KG
- KFG2
- MS
- KKA
- KP
- LQ
- MQR
- T
- IDK

KFG2 Series

Applicable Tubing: Inch Size, Connection Thread: NPT

Dimensions

Straight Union: KFG2H



Applicable tubing size (inch)		Model	Width across flat		L	M	ød	Effective area (mm ²)	Weight (g)
O.D.	I.D.		H ₁	H ₂					
ø1/8" (ø3.18)	ø0.086" (ø2.18)	KFG2H0122-00	8	8	21.8	5	1.5	1.1	7
ø5/32" (ø4)	ø0.098" (ø2.5)	KFG2H0325-00	8	8	21.8	5	1.8	1.6	7
ø1/4" (ø6.35)	ø5/32" (ø3.95)	KFG2H0704-00	12	12	25.2	6	3.3	6	16
ø5/16" (ø8)	ø0.236" (ø6)	KFG2H0906-00	14	14	28.6	6.6	5.3	17	25
ø3/8" (ø9.53)	ø1/4" (ø6.35)	KFG2H1163-00	17	17	33.6	7.6	5.6	19	45
ø1/2" (ø12.7)	ø3/8" (ø9.53)	KFG2H1395-00	19	19	37	8.5	8.5	51	55

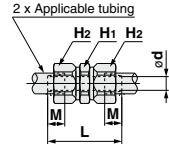

Union Tee: KFG2T



Applicable tubing size (inch)		Model	Width across flat		L	M	ød	Effective area (mm ²)	Weight (g)
O.D.	I.D.		H ₁	H ₂					
ø1/8" (ø3.18)	ø0.086" (ø2.18)	KFG2T0122-00	7	8	13.3	5	1.5	1.1	11
ø5/32" (ø4)	ø0.098" (ø2.5)	KFG2T0325-00	7	8	13.3	5	1.8	1.6	11
ø1/4" (ø6.35)	ø5/32" (ø3.95)	KFG2T0704-00	10	12	16.5	6	3.3	6	26
ø5/16" (ø8)	ø0.236" (ø6)	KFG2T0906-00	12	14	18.7	6.6	5.3	17	39
ø3/8" (ø9.53)	ø1/4" (ø6.35)	KFG2T1163-00	15	17	22.2	7.6	5.6	19	70
ø1/2" (ø12.7)	ø3/8" (ø9.53)	KFG2T1395-00	17	19	24.8	8.5	8.5	51	87

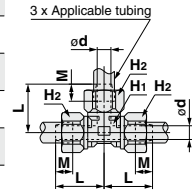

Bulkhead Union: KFG2E



Applicable tubing size (inch)		Model	Width across flat			L ₁	L ₂	M	ød	Mounting hole	Effective area (mm ²)	Weight (g)
O.D.	I.D.		H ₁	H ₂	H ₃							
ø1/8" (ø3.18)	ø0.086" (ø2.18)	KFG2E0122-00	12	8	12	32.8	29.4	5	1.5	10	1.1	16
ø5/32" (ø4)	ø0.098" (ø2.5)	KFG2E0325-00	12	8	12	32.6	29	5	1.8	11	1.6	16
ø1/4" (ø6.35)	ø5/32" (ø3.95)	KFG2E0704-00	17	12	17	39	34.6	6	3.3	13.5	6	39
ø5/16" (ø8)	ø0.236" (ø6)	KFG2E0906-00	17	14	17	40.4	35.8	6.6	5.3	15	17	43
ø3/8" (ø9.53)	ø1/4" (ø6.35)	KFG2E1163-00	22	17	22	46.8	41.4	7.6	5.6	20	19	84
ø1/2" (ø12.7)	ø3/8" (ø9.53)	KFG2E1395-00	26	19	26	51.9	45.5	8.5	8.5	23	51	117

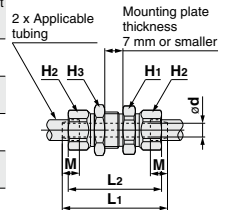

Union Elbow: KFG2L



Applicable tubing size (inch)		Model	Width across flat		L	M	ød	Effective area (mm ²)	Weight (g)
O.D.	I.D.		H ₁	H ₂					
ø1/8" (ø3.18)	ø0.086" (ø2.18)	KFG2L0122-00	7	8	13.3	5	1.5	1.1	8
ø5/32" (ø4)	ø0.098" (ø2.5)	KFG2L0325-00	7	8	13.3	5	2.3	1.6	8
ø1/4" (ø6.35)	ø5/32" (ø3.95)	KFG2L0704-00	10	12	16.5	6	3.3	6	18
ø5/16" (ø8)	ø0.236" (ø6)	KFG2L0906-00	12	14	18.7	6.6	5.3	17	28
ø3/8" (ø9.53)	ø1/4" (ø6.35)	KFG2L1163-00	15	17	22.2	7.6	5.6	19	50
ø1/2" (ø12.7)	ø3/8" (ø9.53)	KFG2L1395-00	17	19	24.8	8.5	8.5	51	62

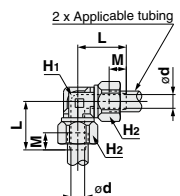

Dimensions

Swivel Elbow: KFG2V



Applicable tubing size (inch)		Connection thread NPT	Model	Width across flat			L1	L2	M	ød	A*	Effective area (mm ²)	Weight (g)
O.D.	I.D.			H1	H2	H3							
ø1/8" (ø3.18)	ø0.086" (ø2.18)	1/8	KFG2V0122-N01	7	8	12	14.5	16.1	5	1.5	17.3	1	11
	ø0.086" (ø2.18)	1/4	KFG2V0122-N02			14		19.8			19.8		19
ø5/32" (ø4)	ø0.098" (ø2.5)	1/8	KFG2V0325-N01	7	8	12	14.5	16.1	5	1.8	17.3	1.4	11
	ø0.098" (ø2.5)	1/4	KFG2V0325-N02			14		19.8			19.8		19
ø1/4" (ø6.35)	ø5/32" (ø3.95)	1/8	KFG2V0704-N01	10	12	12	16.2	18.3	6	3.3	21.7	5	16
	ø5/32" (ø3.95)	1/4	KFG2V0704-N02			14		22			24.2		25
ø5/16" (ø8)	ø0.236" (ø6)	1/8	KFG2V0906-N01			12		19.6			24.1		23
		1/4	KFG2V0906-N02	12	14	14	18.4	23.3	6.6	5.3	26.6	14	31
		3/8	KFG2V0906-N03			19		25.1			28.1		45
ø3/8" (ø9.53)	ø1/4" (ø6.35)	1/4	KFG2V1163-N02			14		24.7			29.7		38
		3/8	KFG2V1163-N03	15	17	19	21.4	26.8	7.6	5.6	31.4	16	51
ø1/2" (ø12.7)	ø3/8" (ø9.53)	1/2	KFG2V1163-N04			22		30.6			33.5		75
		3/8	KFG2V1395-N02			14		25.8			31.8		46
ø1/2" (ø12.7)	ø3/8" (ø9.53)	3/8	KFG2V1395-N03	17	19	23	22	27.8	8.5	8.5	33.5	43	59
		1/2	KFG2V1395-N04			22		31.6			35.6		83

* Reference dimensions after installation of NPT thread

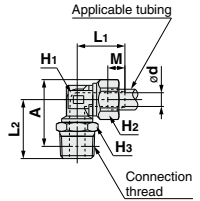

Female Connector: KFG2F



Applicable tubing size (inch)		Connection thread NPT	Model	Width across flat			L1	L2	M	ød	Effective area (mm ²)	Weight (g)
O.D.	I.D.			H1	H2	H3						
ø1/8" (ø3.18)	ø0.086" (ø2.18)	1/4	KFG2F0122-N02	17	8	26.7	17.2	5	1.5	1.1	25	
	ø0.086" (ø2.18)	1/4	KFG2F0325-N02	17	8	26.7	17.2	5	1.8	1.6	23	
ø1/4" (ø6.35)	ø5/32" (ø3.95)	1/4	KFG2F0704-N02	17	12	27.5	16.3	6	3.3	6	28	
	ø5/32" (ø3.95)	3/8	KFG2F0906-N03	19	14	29.4	17	6.6	5.3	17	32	
ø3/8" (ø9.53)	ø1/4" (ø6.35)	3/8	KFG2F1163-N03	19	17	30.5	16.1	7.6	5.6	19	38	
ø1/2" (ø12.7)	ø3/8" (ø9.53)	3/8	KFG2F1395-N03	19	19	31.6	15.6	8.5	8.5	51	42	

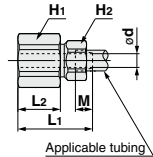

Union Nut: KFG2N



Applicable tubing O.D. (inch)	Model	H (Width across flat)	L	Weight (g)
ø1/8" (ø3.18)	KFG2N-01	8	7.8	1.9
ø5/32" (ø4)	KFG2N-03	8	7.7	1.9
ø1/4" (ø6.35)	KFG2N-07	12	9	4.6
ø5/16" (ø8)	KFG2N-09	14	10.1	6.7
ø3/8" (ø9.53)	KFG2N-11	17	11.7	10.7
ø1/2" (ø12.7)	KFG2N-13	19	12.8	13

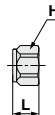

KQ2
KQB2
KS
KX
KM
KF
M
H/DL
L/LL
KC
KK
KK130
DM
KDM
KB
KR
KA
KQG2
KG
KFG2
MS
KKA
KP
LQ
MQR
T
IDK



KFG2 Series

Applicable Fluid List

How to Read the Table

- ⊙: Completely unaffected or largely unaffected.
- : May be slightly affected, but, dependent upon condition, can sufficiently withstand.
- △: Advisable to use as little as possible.
- ×: Not applicable, as substantially affected.
- : No data is available.

Compatibility Checklist for Used Materials and Fluids

Chemical	Body	Seal
	Stainless steel 316	Special FKM
Acrylonitrile	⊙	×
Acetamide	○	○
Acetaldehyde	⊙	×
Acetone	⊙	×
Aniline	○	⊙
Amylene	⊙	—
Sulphurous acid gas (Humid gas)	⊙	—
Sodium bisulfite [50%]	⊙	—
Allyl alcohol	⊙	—
Benzoic acid	⊙	—
Ammonia (Compressed gas)	⊙	×
Isopropyl alcohol	○	⊙
Isophorone	×	—
Ethyl alcohol	⊙	○
Ethyl ether	○	×
Ethylene	⊙	—
Ethylene glycol	○	⊙
Ethylene diamine	⊙	—
Ethylene dichloride	⊙	—
Epichlorohydrine	⊙	×
Methyl tertiary butyl ether	—	×
Allyl chloride	×	—
Ammonium chloride	⊙	—
Calcium chloride	⊙	—
Iron(II) chloride [5%]	×	—
Sodium chloride	○	—
Magnesium chloride	⊙	—
Hydrochloric acid [5%]	×	—
Chlorine gas (Humid gas)	×	—
Carbitol	×	—
Formic acid [50%]	○	×
o-Xylene	△	△
p-Xylene	△	△
Citric acid	⊙	—
Cumene	×	—
Glycerin	⊙	⊙
Cresol	⊙	△

Chemical	Body	Seal
	Stainless steel 316	Special FKM
Chromic acid [10%]	⊙	—
Chlorosulfonic acid	○	×
Chlorofluorocarbon (CFC) 11	—	×
Chlorofluorocarbon (CFC) 113	—	×
Chlorofluorocarbon (CFC) 12	○	×
Chlorofluorocarbon (CFC) 13B1	—	×
Chlorofluorocarbon (CFC) 14	—	⊙
Chlorofluorocarbon (CFC) 22	○	×
Chlorobenzene	×	○
Chloroform (Trichloromethane)	○	○
Acetic acid	○	×
Amyl acetate	⊙	×
Isopropyl acetate [20%]	⊙	×
Ethyl acetate	×	×
Butyl acetate	×	×
Methyl acetate	⊙	×
Calcium hypochlorite	⊙	—
Sodium hypochlorite [5%]	⊙	⊙
Potassium cyanide [50%]	⊙	—
Copper cyanide	⊙	—
Diisobutyl ketone	⊙	—
Diisobutylene	—	⊙
Diethanolamine	⊙	—
Diethylamine	×	×
Diethylene glycol	⊙	—
Carbon tetrachloride	⊙	⊙
Cyclohexanol	×	—
Cyclohexanone	×	×
Cyclohexane	×	○
Dichloroethylene	—	△
Dichlorobenzene	—	△
Dichloromethane (Methylene chloride)	△	△
Ethylene bromide	×	—
Potassium bromide [30%]	⊙	—
Potassium dichromate [25%]	⊙	—
Oxalic acid	⊙	—
Bromine gas	×	—

Chemical	Body	Seal
	Stainless steel 316	Special FKM
Tartaric acid	⊙	—
Nitric acid [65%]	⊙	⊙
Ammonium nitrate	⊙	—
Ammonium hydroxide	—	○
Calcium hydroxide	⊙	—
Sodium hydroxide [50%]	⊙	○
Barium hydroxide	⊙	—
Solvent naphtha	⊙	—
Carbonic acid (Humid gas and aqueous solution)	⊙	—
Tetrachloroethylene	×	⊙
Tetrahydrofuran	—	×
Dodecylbenzene	⊙	—
Trichloroethane	△	—
Trichloroethylene	⊙	○
Trichloroacetic acid	—	—
Toluene	⊙	⊙
Naphtha	○	○
Naphthenic acid	⊙	—
Lactic acid	⊙	—
Carbon disulfide	○	⊙
Picric acid	⊙	—
Pyridine	×	×
Phenol	×	○
Butyl phthalate	×	—
Butyl alcohol	△	—
Hydrofluoric acid [50%]	⊙	—
Furfural	×	×
n-Propyl alcohol	⊙	—
Propylene glycol	⊙	—
Bromochloroethane	—	×
n-Hexane	○	⊙
n-Hexyl alcohol	⊙	—
n-Heptane	⊙	—
Benzene	×	×
n-Pentane	×	—
Boric acid	⊙	—
Gallic acid	⊙	—

Chemical	Body	Seal
	Stainless steel 316	Special FKM
Formic aldehyde	⊙	×
Methyl methacrylate	×	×
Methyl alcohol	⊙	○
Methyl isobutyl ketone	×	×
Methyl ethyl ketone	×	×
Ethyleneglycol monomethyl ether	×	—
Monoethanolamine	⊙	—
Morpholine	⊙	—
Butyric acid	⊙	—
Hydrogen sulfide (Humid gas and aqueous solution)	⊙	×
Sulphuric acid [10%]	⊙	⊙
Ammonium sulfate	⊙	×
Sodium bisulfate [10%]	⊙	—
Iron(II) sulfate	○	—
Sodium sulfate	⊙	—
Phosphoric acid [85%]	⊙	—

KQ2
KQB2
**KS
KX**
KM
KF
M
**H/DL
L/LL**
KC
KK
KK130
DM
KDM
KB
KR
KA
KQG2
KG
KFG2
MS
KKA
KP
LQ
MQR
T
IDK

Note 1) [] denotes the concentration. Aqueous solutions without condensation notes are in a saturated state.

Note 2) The above data is based on a room temperature of 20°C. Note that you may obtain different figures, depending on temperature conditions.

Note 3) The above data shows compatibility guidelines based upon component parts. Therefore, it is no guarantee of product performance. In addition, using fluids other than those specified in the catalog are not covered by the product's warranty.



KFG2 Series

Specific Product Precautions 1

Be sure to read this before handling the products.

Refer to back page 50 for Safety Instructions and pages 13 to 17 for Fittings and Tubing Precautions.

Selection

⚠ Caution

1. Consult with SMC regarding fluids other than air, water and steam.
2. When using the swivel elbow fittings, particles may be generated by rotation for positioning after connecting. If you are concerned about the effects on machinery and equipment, check the particle generation with your machine before use.

Mounting

⚠ Caution

1. The swivel elbow fittings can be rotated for positioning, but they cannot be used rotating.
This will cause metal debris by wearing, which may enter the operating fluid or cause fitting damage.
2. Keep the connection part of fittings and tubes from rotating or oscillating movement.
Failure to do so may cause the fittings to break. In particular, for the swivel elbow, the repeated load from the connection tube may cause the stud to come off.

Piping

⚠ Caution

1. Take a tube having no flaws on its periphery and cut it off at right angles.
(Use a tube cutter TK-1, 2, 3. Do not use pinchers, nippers or scissors, etc.)
The tube might be cut diagonally or flattened, making installation impossible or causing problems such as disconnection and leakage.
2. Insert the tube into the union nut with the union nut removed. Grab the tube and gently push it thoroughly into the fitting.

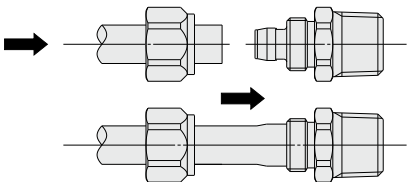

3. After insertion, tighten the union nut temporarily by hand.

Piping

⚠ Caution

4. Fix the body with a tool. Tighten the union nut to the end surface of the body using a suitable wrench.
Hex. across flats may be deformed, if using an improper wrench for hex. across flats.
If the body is not secured with a tool, this may cause breakage. (In particular, for the swivel elbow, the stud may come off.)

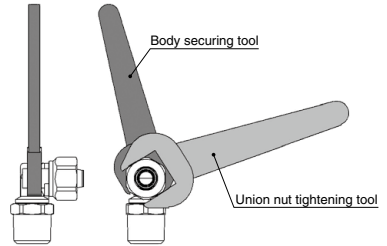

5. Fix the body with a tightening tool. Tighten the union nut to the end surface of the body using a suitable wrench.

Hex. across flats may be deformed, if using an improper wrench for hex. across flats. Tighten the union nut with the proper tightening torque shown below.

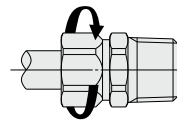

Fitting size	Proper tightening torque N·m
KFG2□01	2 to 3
KFG2□03	
KFG2□04	
KFG2□06	3 to 4
KFG2□07	
KFG2□08	5 to 6
KFG2□09	
KFG2□10	8 to 10
KFG2□11	
KFG2□12	10 to 12
KFG2□13	
KFG2□16	16 to 18

Operating Environment

⚠ Warning

1. Avoid installing and using fittings inside a food zone.

Not installable

Food zone An environment where food which will be sold as merchandise, directly touches the fitting components.

Installable

Splash zone An environment where food which will not be sold as merchandise, directly touches the fitting components.

Non-food zone An environment where there is no contact with food.



KFG2 Series

Specific Product Precautions 2

Be sure to read this before handling the products.

Refer to back page 50 for Safety Instructions and pages 13 to 17 for Fittings and Tubing Precautions.

Maintenance

⚠ Caution

1. Pre-maintenance inspection

When the product is removed, turn off the power, cut off the supply pressure, and confirm that fluid in the piping has been discharged.

2. During regular maintenance, check for the following and replace any components as necessary.

- a) Scratches, gouges, abrasion, corrosion
- b) Leakage
- c) Flattening or distortion of the tube
- d) Hardening, deterioration or softness of the tube
- e) Loosening of the union nut

3. Do not repair the fittings or patch the tube for reuse.

4. After operation at a high temperature, leakage may occur due to time dependent change of the tube material. If leakage occurs, remove the tube, cut off the connecting part of the tube, and connect to the piping again.

Check if the tube dimension accuracy is within the recommended tolerance. If it is difficult to take the tube out of the body, bend the tube to the side to remove.

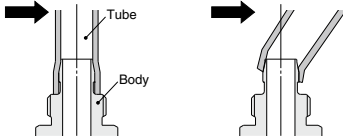

Stainless steel

Metal exists in nature as ore (like oxide or sulfide). This means that oxide or sulfide is more stable than pure metal. Accordingly, metallic material chemically oxidizes (metallic constituent becomes ion and melts out). It corrodes in the natural environment.

Even though corrosion of metal easily occurs in an environment where oxidizing tendency is stronger, some kinds of metal have a characteristic for which corrosion never happens if the level of oxidizing goes higher than a specific point. In such a case, it is called "metal in passive state".

Stainless steel has corrosion resistance because of a thin coat of passive state on its surface. However, there does not exist stainless steel with absolute corrosion resistance; therefore, many types of stainless steel have been developed for improved corrosion resistance performance.

KQ2
KQB2
KS KX
KM
KF
M
H/DL L/LL
KC
KK
KK130
DM
KDM
KB
KR
KA
KQG2
KG
KFG2
MS
KKA
KP
LQ
MQR
T
IDK