

S Couplers

KKK Series

Stainless steel type

RoHS

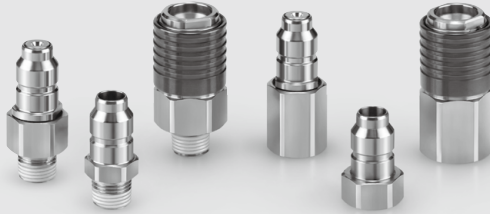

- **Body material: Stainless steel 304**
Seal material: Fluororubber (Special FKM)
- **Both plug and socket have an integral check valve.**
Available with and without check valves depending on the operating conditions.
- **Reduces liquid dripping when the plug and socket are uncoupled.**
Liquid dripping: 0.02 to 0.77 cm³ at each removal
Aeration: 0.1 to 2.7 cm³ at each removal

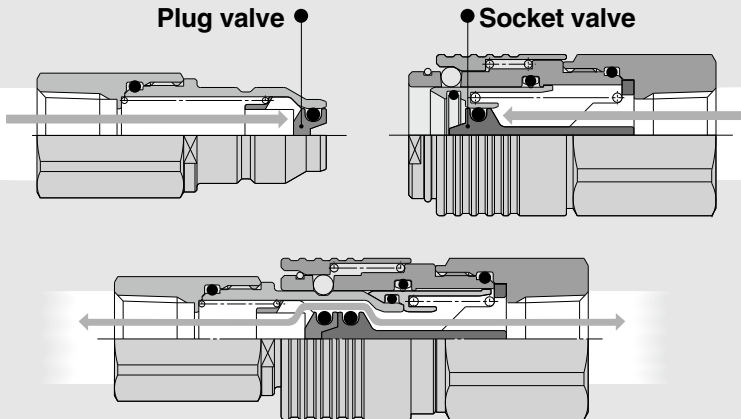

- **Non-greased specification (standard)**
Allows smooth installation and removal even without grease
 - O-ring: Fluorine coated
 - Sliding parts of plug and socket: Fluorine coated is used.

- **Fluid: Water, Air**
- **Operating temperature range: -5 to 150°C**

Note) This product should not be used with steam.



KQ2

KQB2

KS
KX

KM

KF

M

H/DL
L/LL

KC

KK

KK130

DM

KDM

KB

KR

KA

KQG2

KG

KFG2

MS

KKK

KP

LQ

MQR

T

IDK

KKA Series

Plug (P)

Male thread type

Body size	Port size	Part no.	
		With check valve	Without check valve
1/8	R 1/8	KKA3P-01M	KKA3P-01M-1
	R 1/4	-02M	-02M-1
	R 3/8	-03M	-03M-1
1/4	R 1/4	KKA4P-02M	KKA4P-02M-1
	R 3/8	-03M	-03M-1
	R 1/2	-04M	-04M-1
1/2	R 3/8	KKA6P-03M	KKA6P-03M-1
	R 1/2	-04M	-04M-1
	R 3/4	-06M	-06M-1
3/4	R 1/2	KKA7P-04M	—
	R 3/4	-06M	—
	R 1	-10M	—
1	R 3/4	KKA8P-06M	—
	R 1	-10M	—
	R 1 1/4	-12M	—
1 1/4	R 1	KKA9P-10M	—
	R 1 1/4	-12M	—
	R 1 1/2	-14M	—



With check valve

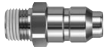

Without check valve

Socket (S)

Male thread type

Body size	Port size	Part no.	
		With check valve	Without check valve
1/8	R 1/8	KKA3S-01M	KKA3S-01M-1
	R 1/4	-02M	-02M-1
	R 3/8	-03M	-03M-1
1/4	R 1/4	KKA4S-02M	KKA4S-02M-1
	R 3/8	-03M	-03M-1
	R 1/2	-04M	-04M-1
1/2	R 3/8	KKA6S-03M	KKA6S-03M-1
	R 1/2	-04M	-04M-1
	R 3/4	-06M	-06M-1
3/4	R 1/2	KKA7S-04M	—
	R 3/4	-06M	—
	R 1	-10M	—
1	R 3/4	KKA8S-06M	—
	R 1	-10M	—
	R 1 1/4	-12M	—
1 1/4	R 1	KKA9S-10M	—
	R 1 1/4	-12M	—
	R 1 1/2	-14M	—



Female thread type

Body size	Port size	Part no.	
		With check valve	Without check valve
1/8	Rc 1/8	KKA3P-01F	KKA3P-01F-1
	Rc 1/4	-02F	-02F-1
	Rc 3/8	-03F	-03F-1
1/4	Rc 1/4	KKA4P-02F	KKA4P-02F-1
	Rc 3/8	-03F	-03F-1
	Rc 1/2	-04F	-04F-1
1/2	Rc 3/8	KKA6P-03F	KKA6P-03F-1
	Rc 1/2	-04F	-04F-1
	Rc 3/4	-06F	-06F-1
3/4	Rc 1/2	KKA7P-04F	—
	Rc 3/4	-06F	—
	Rc 1	-10F	—
1	Rc 3/4	KKA8P-06F	—
	Rc 1	-10F	—
	Rc 1 1/4	-12F	—
1 1/4	Rc 1	KKA9P-10F	—
	Rc 1 1/4	-12F	—
	Rc 1 1/2	-14F	—



With check valve



Without check valve

Female thread type

Body size	Port size	Part no.	
		With check valve	Without check valve
1/8	Rc 1/8	KKA3S-01F	KKA3S-01F-1
	Rc 1/4	-02F	-02F-1
	Rc 3/8	-03F	-03F-1
1/4	Rc 1/4	KKA4S-02F	KKA4S-02F-1
	Rc 3/8	-03F	-03F-1
	Rc 1/2	-04F	-04F-1
1/2	Rc 3/8	KKA6S-03F	KKA6S-03F-1
	Rc 1/2	-04F	-04F-1
	Rc 3/4	-06F	-06F-1
3/4	Rc 1/2	KKA7S-04F	—
	Rc 3/4	-06F	—
	Rc 1	-10F	—
1	Rc 3/4	KKA8S-06F	—
	Rc 1	-10F	—
	Rc 1 1/4	-12F	—
1 1/4	Rc 1	KKA9S-10F	—
	Rc 1 1/4	-12F	—
	Rc 1 1/2	-14F	—



Refer to pages 227 to 230 for Specific Product Precautions.

S Couplers



KKK Series

Stainless steel type



Symbol

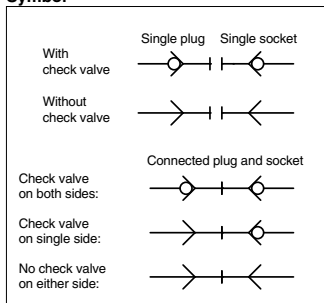

Characteristics with check valve on both sides

Body size	Liquid dripping cm ³ at each removal	Aeration cm ³ at each removal
KKA3	0.02	0.1
KKA4	0.04	0.1
KKA6	0.06	0.2
KKA7	0.14	0.5
KKA8	0.27	0.9
KKA9	0.77	2.7

Liquid dripping:

Volume of water leakage at the time when the plug and socket are uncoupled.

Aeration:

Volume of external air entrained when the plug and socket are connected.

Specifications

Fluid	Water, Air, N ₂
Operating pressure range	Note 1) KKA3: -100 kPa to 1 MPa KKA4/6/7/8/9: 0 to 1 MPa
Proof pressure	10 MPa
Ambient and fluid temperature	-5 to 150°C (No freezing) Note) This product should not be used with steam.
Non-greased specification	No grease is used. (Rubber, Metal sliding parts: Fluorine coated)
Material	Metal part: Stainless steel 304, Rubber material: Fluororubber (Special FKM)
Seal	With male thread sealant

Note 1) Do not use the S couplers with a leak tester or for vacuum retention because they are not guaranteed for zero leakage.

Performance

Plug and socket connection	One-touch connection and release
Check valve	Check valve on both sides, Without check valve

Note) KKA series cannot be connected with KK series or KKH series.

Effective Area

	Plug	Socket	Effective area mm ²
Plug: With check valve Socket: With check valve	KKA3P-01F	KKA3S-01F	17.4
	KKA4P-02F	KKA4S-02F	26.4
	KKA6P-04F	KKA6S-04F	54.2
	KKA7P-06F	KKA7S-06F	99.6
	KKA8P-10F	KKA8S-10F	168.3
Plug: Without check valve Socket: With check valve	KKA9P-12F	KKA9S-12F	332.1
	KKA3P-01M-1	KKA3S-01M	18.5
	KKA4P-02M-1	KKA4S-02M	31.8
	KKA6P-04M-1	KKA6S-04M	55.3
	KKA3P-01M-1	KKA3S-01M-1	22.6
Plug: Without check valve Socket: Without check valve	KKA4P-02M-1	KKA4S-02M-1	40.2
	KKA6P-04M-1	KKA6S-04M-1	76.0

How to Order

KKK 4 P - 02 M

Body size

3	1/8
4	1/4
6	1/2
7	3/4
8	1
9	1 1/4

Socket/Plug designation

P	Plug
S	Socket

Port size

Symbol	Thread size
01	R, Rc 1/8
02	R, Rc 1/4
03	R, Rc 3/8
04	R, Rc 1/2
06	R, Rc 3/4
10	R, Rc 1
12	R, Rc 1 1/4
14	R, Rc 1 1/2

Built-in check valve

Nil	With check valve
-1	Without check valve

Note) KKA7/8/9 is not available without a check valve. Contact us when such a type is needed.

Connection type

Symbol	Type
M	Male thread (with sealant)
F	Female thread

	Plug	Socket	Availability
Built-in check valve	Yes	Yes	○
	No	Yes	○
	No	No	○
	Yes	No	×

Note) A plug with check valve should be used in combination with a socket with check valve.
If a socket without check valve is used, the check valve of the plug will not open.

For details on body size and port size combinations for each model, refer to the charts on the Dimensions page.



KKA Series

Flow Rate Characteristics

Air

Plug: With check valve Socket: With check valve

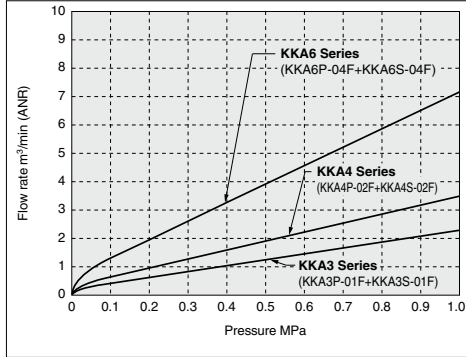

Plug: With check valve Socket: With check valve

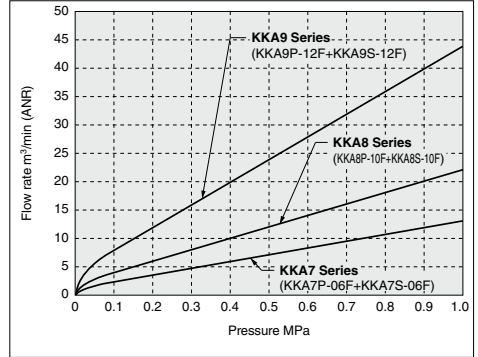

Plug: Without check valve Socket: With check valve

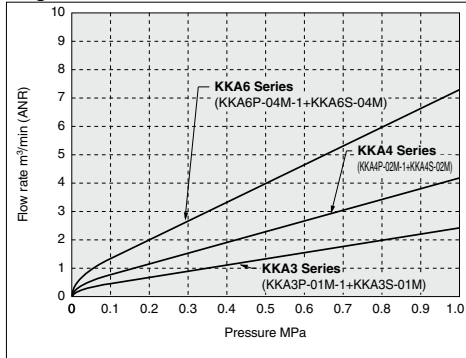

Plug: Without check valve Socket: Without check valve

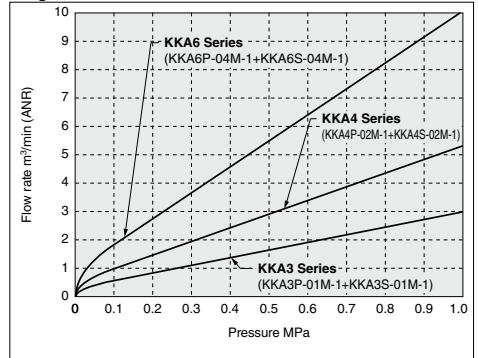

Pressure Loss

Water

Plug: With check valve Socket: With check valve

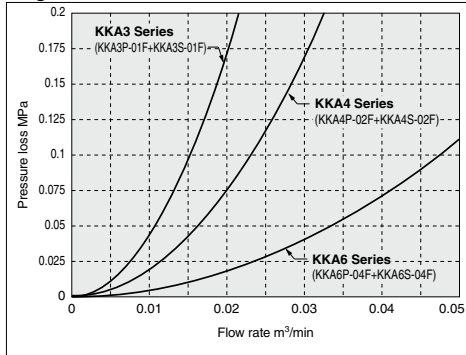

Plug: With check valve Socket: With check valve

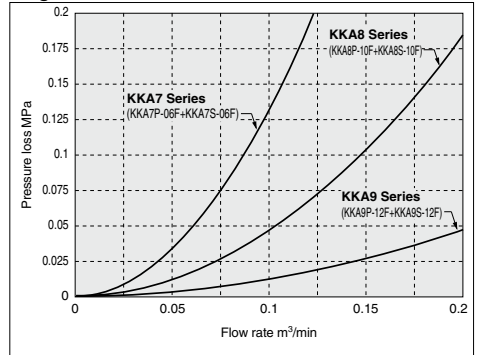

Construction

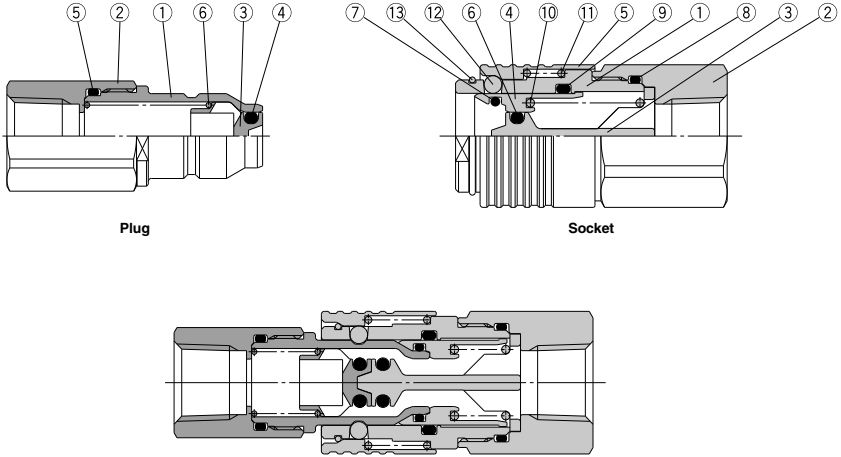

Plug

No.	Description	Material	Note
1	Stem	Stainless steel 304	Fluorine coated
2	Rear stem	Stainless steel 304	
3	Plug valve	Stainless steel 304	
4	Valve O-ring	Special FKM	Fluorine coated
5	Stem O-ring	Special FKM	Fluorine coated
6	Plug valve spring	Equivalent to Stainless steel 304 Stainless steel 304	KKA3 KKA4, 6, 7, 8, 9

Socket

No.	Description	Material	Note
1	Body	Stainless steel 304	
2	Rear body	Stainless steel 304	
3	Socket valve	Stainless steel 304	
4	Collar	Stainless steel 304	Fluorine coated
5	Sleeve	Stainless steel 304	Plated with fluorine-contained material
6	Valve O-ring	Special FKM	Fluorine coated
7	Plug O-ring	Special FKM	Fluorine coated
8	Body O-ring	Special FKM	Fluorine coated
9	Collar seal	Special FKM	Fluorine coated
10	Collar spring	Equivalent to Stainless steel 304 Stainless steel 304	KKA3, 4, 6 KKA7, 8, 9
11	Sleeve spring	Stainless steel 304	
12	Steel ball	Stainless steel 304	
13	Stopper ring	Stainless steel 304	

KKA Series Spare Parts

Description	Product no.	No.
Plug O-ring	KKA3S-P01	Socket ⑦
	KKA4S-P01	
	KKA6S-P01	
	KKA7S-P01	
	KKA8S-P01	
	KKA9S-P01	

KQ2

KQB2

KS
KX

KM

KF

M

H/DL
L/LL

KC

KK

KK130

DM

KDM

KB

KR

KA

KQG2

KG

KFG2

MS

KKA

KP

LQ

MQR

T

IDK

KKA Series

Dimensions/Plug (P)

With check valve

Male thread type

(mm)



Body size	Model	T Connection port size	H Width across flats	L1	L2	A	Min. bore size	Effective area mm ²	Weight g
1/8	KKA3P-01M	R 1/8	14	35.4	16.0	31.4	5.6	17.4	15.4
	-02M	R 1/4		38.4		32.4			19.8
	-03M	R 3/8		39.4		32.9			32.9
1/4	KKA4P-02M	R 1/4	17	42.2	18.9	36.2	6.9	26.4	28.3
	-03M	R 3/8		43.2		36.7			36.6
	-04M	R 1/2		22		46.2			38.2
1/2	KKA6P-03M	R 3/8	24	47.1	20.4	40.6	10.0	54.2	60.3
	-04M	R 1/2		47.9		39.9			69.2
	-06M	R 3/4		30		49.9			40.4
3/4	KKA7P-04M	R 1/2	32	66.3	27.6	58.1	13.5	99.6	173.9
	-06M	R 3/4		69.4		59.9			209.6
	-10M	R 1		36		69.9			59.5
1	KKA8P-06M	R 3/4	41	82.9	35.6	73.4	17.5	168.3	362.8
	-10M	R 1		85.4		75.0			403.9
	-12M	R 1 1/4		46		85.4			72.7
1 1/4	KKA9P-10M	R 1	55	109.5	49.1	99.1	24.6	332.1	824.1
	-12M	R 1 1/4		109.0		96.3			861.4
	-14M	R 1 1/2		109.0		96.3			936.3

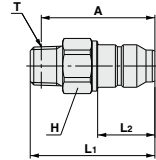

Female thread type

(mm)



Body size	Model	T Connection port size	H Width across flats	L1	L2	Min. bore size	Effective area mm ²	Weight g	
1/8	KKA3P-01F	Rc 1/8	14	36.0	16.0	5.6	17.4	20.2	
	-02F	Rc 1/4		39.6				31.8	
	-03F	Rc 3/8		17				40.4	35.8
1/4	KKA4P-02F	Rc 1/4	17	43.4	18.9	6.9	26.4	36.1	
	-03F	Rc 3/8		19				44.4	40.2
	-04F	Rc 1/2		19				48.6	69.7
1/2	KKA6P-03F	Rc 3/8	24	48.7	20.4	10.0	54.2	84.1	
	-04F	Rc 1/2		52.9				79.7	
	-06F	Rc 3/4		30				54.6	123.8
3/4	KKA7P-04F	Rc 1/2	32	67.7	27.6	13.5	99.6	217.1	
	-06F	Rc 3/4		69.4				196.8	
	-10F	Rc 1		72.4				325.9	
1	KKA8P-06F	Rc 3/4	41	82.0	35.6	17.5	168.3	420.5	
	-10F	Rc 1		85.0				391.3	
	-12F	Rc 1 1/4		50				87.3	552.8
1 1/4	KKA9P-10F	Rc 1	55	107.8	49.1	24.6	332.1	986.9	
	-12F	Rc 1 1/4		110.1				925.6	
	-14F	Rc 1 1/2		110.1				848.2	

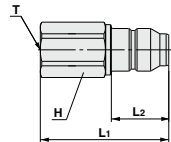

Dimensions/Socket (S)

With check valve

Male thread type

(mm)



Body size	Model	T Connection port size	H Width across flats	øD	L	A	Min. bore size	Effective area mm ²	Weight g
1/8	KKA3S-01M	R 1/8	17	18.5	38.1	34.1	5.9	18.5	38.5
	-02M	R 1/4			41.1	35.1			41.8
	-03M	R 3/8			42.1	35.6			46.3
1/4	KKA4S-02M	R 1/4	22	24.2	46.0	40.0	7.7	31.8	76.8
	-03M	R 3/8			47.0	40.5			78.5
	-04M	R 1/2			50.0	42.0			86.6
1/2	KKA6S-03M	R 3/8	30	30.7	51.4	44.9	10.2	55.3	149.1
	-04M	R 1/2			54.4	46.4			160.4
	-06M	R 3/4			56.4	46.9			184.8
3/4	KKA7S-04M	R 1/2	36	42.5	76.3	68.1	13.6	101.5	426.1
	-06M	R 3/4			79.3	69.8			457.8
	-10M	R 1			82.8	72.4			514.0
1	KKA8S-06M	R 3/4	46	55	94.9	85.4	17.6	169.9	873.5
	-10M	R 1			98.4	88.0			931.1
	-12M	R 1 1/4			100.4	87.7			1012.9
1 1/4	KKA9S-10M	R 1	63	69	125.5	115.1	22.0	264.9	1680.7
	-12M	R 1 1/4			127.5	114.8			1758.1
	-14M	R 1 1/2			127.5	114.8			1819.4

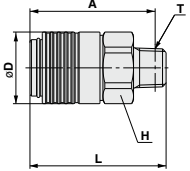

Female thread type

(mm)



Body size	Model	T Connection port size	H Width across flats	øD	L	Min. bore size	Effective area mm ²	Weight g
1/8	KKA3S-01F	Rc 1/8	17	18.5	37.6	5.9	18.5	46.9
	-02F	Rc 1/4			41.2			47.2
	-03F	Rc 3/8			43.1			52.3
1/4	KKA4S-02F	Rc 1/4	22	24.2	46.1	7.7	31.8	97.1
	-03F	Rc 3/8			46.9			91.1
	-04F	Rc 1/2			52.3			104.3
1/2	KKA6S-03F	Rc 3/8	30	30.7	50.5	10.2	55.3	189.6
	-04F	Rc 1/2			56.2			202.0
	-06F	Rc 3/4			57.9			180.6
3/4	KKA7S-04F	Rc 1/2	36	42.5	75.1	13.6	101.5	477.2
	-06F	Rc 3/4			76.5			457.4
	-10F	Rc 1			82.3			550.9
1	KKA8S-06F	Rc 3/4	46	55	90.9	17.6	169.9	935.2
	-10F	Rc 1			93.9			914.7
	-12F	Rc 1 1/4			99.2			1002.1
1 1/4	KKA9S-10F	Rc 1	63	69	121.8	25.1	344.9	1919.1
	-12F	Rc 1 1/4			121.8			1810.0
	-14F	Rc 1 1/2			121.8			1732.6

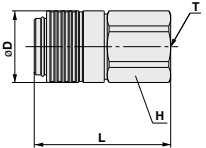

- KQ2
- KQB2
- KS
- KX
- KM
- KF
- M
- H/DL
- L/LL
- KC
- KK
- KK130
- DM
- KDM
- KB
- KR
- KA
- KQG2
- KG
- KFG2
- MS
- KKA**
- KP
- LQ
- MQR
- T
- IDK

KKA Series

Dimensions/Plug (P)

Without check valve

Male thread type

(mm)



Body size	Model	T Connection port size	H Width across flats	L1	L2	A	Min. bore size	Effective area mm ²	Weight g
1/8	KKA3P-01M-1	R 1/8	12	28.5	16.0	24.5	6.0	22.6	9.8
	-02M-1	R 1/4	14	31.5		25.5			14.6
	-03M-1	R 3/8	17	32.5		26.0			23.6
1/4	KKA4P-02M-1	R 1/4	17	34.4	18.9	28.4	8.0	40.2	21.0
	-03M-1	R 3/8		35.4		28.9			27.9
	-04M-1	R 1/2		39.4		31.4			50.2
1/2	KKA6P-03M-1	R 3/8	22	37.9	20.4	31.4	11.0	76.0	41.9
	-04M-1	R 1/2		40.9		32.9			56.0
	-06M-1	R 3/4		42.9		33.4			98.7

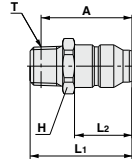

Female thread type

(mm)



Body size	Model	T Connection port size	H Width across flats	L1	L2	Min. bore size	Effective area mm ²	Weight g
1/8	KKA3P-01F-1	Rc 1/8	14	23.2	16.0	6.0	22.6	9.6
	-02F-1	Rc 1/4	17	30.3				20.2
	-03F-1	Rc 3/8	19	32.0				26.2
1/4	KKA4P-02F-1	Rc 1/4	17	29.7	18.9	8.0	40.2	20.0
	-03F-1	Rc 3/8	19	34.0				25.8
	-04F-1	Rc 1/2	24	39.4				46.1
1/2	KKA6P-03F-1	Rc 3/8	22	30.9	20.4	11.0	76.0	34.3
	-04F-1	Rc 1/2	24	39.6				50.0
	-06F-1	Rc 3/4	30	42.8				78.6

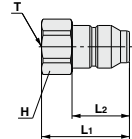

Dimensions/Socket (S)

Without check valve

Male thread type

(mm)



Body size	Model	T Connection port size	H Width across flats	øD	L	A	Min. bore size	Effective area mm ²	Weight g
1/8	KKA3S-01M-1	R 1/8	17	18.5	38.1	34.1	6.1	23.4	36.1
	-02M-1	R 1/4			41.1	35.1			39.4
	-03M-1	R 3/8			42.1	35.6			43.9
1/4	KKA4S-02M-1	R 1/4	22	24.2	46.0	40.0	8.1	41.2	71.9
	-03M-1	R 3/8			47.0	40.5			73.6
	-04M-1	R 1/2			50.0	42.0			81.7
1/2	KKA6S-03M-1	R 3/8	30	30.7	51.4	44.9	11.4	81.6	138.3
	-04M-1	R 1/2			54.4	46.4			149.6
	-06M-1	R 3/4			56.4	46.9			174.0

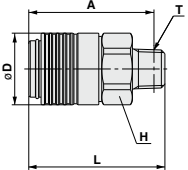

Female thread type

(mm)



Body size	Model	T Connection port size	H Width across flats	øD	L	Min. bore size	Effective area mm ²	Weight g
1/8	KKA3S-01F-1	Rc 1/8	17	18.5	37.6	6.1	23.4	44.5
	-02F-1	Rc 1/4			41.2			44.8
	-03F-1	Rc 3/8			43.1			49.9
1/4	KKA4S-02F-1	Rc 1/4	22	24.2	46.1	8.1	41.2	92.2
	-03F-1	Rc 3/8			46.9			86.2
	-04F-1	Rc 1/2			52.3			99.4
1/2	KKA6S-03F-1	Rc 3/8	30	30.7	50.5	11.4	81.6	178.8
	-04F-1	Rc 1/2			56.2			191.2
	-06F-1	Rc 3/4			57.9			169.8

