

Mist Separator Regulator AWM20 to AWM40

Micro Mist Separator Regulator AWD20 to AWD40

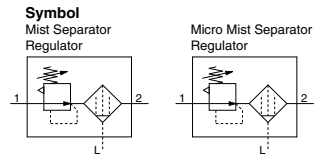

- The AWM series is made up of a regulator and a mist separator to provide optimum results in applications such as clean air blow operations. (Nominal filtration rating: 0.3 μm)
- The AWD series is made up of a regulator and a micro mist separator to provide optimum results in applications such as ultraclean air blow operations. (Nominal filtration rating: 0.01 μm)

How to Order

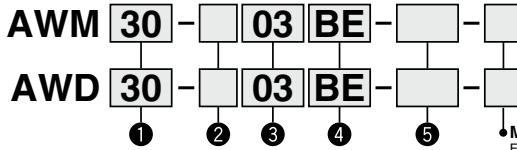

• Option/Semi-standard: Select one each for a to i.
 • Option/Semi-standard symbol: When more than one specification is required, indicate in alphanumeric order.
 Example) AWM30-03BE-1N

For details, refer to pages 594 and 595.

	Symbol	Description	①			
			Body size			
			20	30	40	
②	Thread type	Nil				
		N ^{Note 1)}				
		F ^{Note 2)}				
+						
③	Port size	01		—	—	
		02				
		03				
		04				
+						
④ Option	a	Mounting	Nil			
			B ^{Note 4)}			
			H			
	+					
	b	Float type auto drain	Nil			
			C			
			D			
	+					
	c	Pressure gauge	Nil			
			E			
			G			
			M			
Digital pressure switch		E1 ^{Note 5)}				
		E2 ^{Note 5)}				
		E3 ^{Note 5)}				
+						
⑤ Semi-standard	d	Set pressure ^{Note 6)}	Nil			
			1 ^{Note 7)}			
	+					
	e	Bowl ^{Note 8)}	Nil			
			2			
			6			
			8			
			C			
	+					
	f	Drain port ^{Note 9)}	Nil			
J ^{Note 10)}						
W ^{Note 11)}						

Mist Separator Regulator **AWM20 to AWM40 Series**

Micro Mist Separator Regulator **AWD20 to AWD40 Series**



AWM20, AWD20 AWM40, AWD40

		Symbol	Description	①			
				Body size			
				20	30	40	
⑤	g	Exhaust mechanism	Nil	Relieving type	●	●	●
			N	Non-relieving type	●	●	●
					+		
	h	Flow direction	Nil	Flow direction: Left to right	●	●	●
			R	Flow direction: Right to left	●	●	●
					+		
i	Pressure unit	Nil	Name plate, caution plate for bowl, and pressure gauge in imperial units: MPa	●	●	●	
		Z ^{Note 12)}	Name plate, caution plate for bowl, and pressure gauge in imperial units: psi, "F	○ ^{Note 14)}	○ ^{Note 14)}	○ ^{Note 14)}	
		ZA ^{Note 13)}	Digital pressure switch: With unit conversion function	△ ^{Note 15)}	△ ^{Note 15)}	△ ^{Note 15)}	

Note 1) Drain guide is NPT1/8 (applicable to the AWM20, AWD20) and NPT1/4 (applicable to the AWM30 to AWM40, AWD30 to AWD40). The auto drain port comes with $\phi 3/8$ " one-touch fitting (applicable to the AWM30 to AWM40, AWD30 to AWD40).

Note 2) Drain guide is G1/8 (applicable to the AWM20, AWD20) and G1/4 (applicable to the AWM30 to AWM40, AWD30 to AWD40).

Note 3) Option B, G, H, M are not assembled and supplied loose at the time of shipment.

Note 4) Assembly of a bracket and set nuts

Note 5) When choosing with H (panel mount), the installation space for lead wires will not be secured. In this case, select "wiring bottom entry" for the electrical entry.

Note 6) Float type auto drain: when used in combination with C or D, minimum set pressure is: N.O. type-0.1 MPa; N.C. type-0.1 MPa (AD27) and 0.15 MPa (AD37/47).

Note 7) The only difference from the standard specifications is the adjusting spring for the regulator. It does not restrict the setting of 0.2 MPa or more. When the pressure gauge is attached, a 0.2 MPa pressure gauge will be fitted.

Note 8) Refer to Chemical Data on page 387 when selecting a case material.

Note 9) Float type auto drain: The combination of C and D is not possible.

Note 10) Without a valve function

Note 11) Metal bowl: The combination of 2 and 8 is not possible.

Note 12) For thread type: NPT. This product is for overseas use only according to the new Measurement Law. (The SI unit type is provided for use in Japan.) The digital pressure switch will be equipped with the unit conversion function, setting to psi initially.

The combination of the round type pressure gauge with color zone "M" and a psi display "Z" is not orderable as a standard product. However, this combination is available as a special.

Note 13) For options: E1, E2, E3, E4. This product is for overseas use only according to the new Measurement Law. (The SI unit is provided for use in Japan.)

Note 14) ○: For thread type: NPT only

Note 15) △: Select with options: E1, E2, E3, E4.

Standard Specifications

Model	AWM20 AWD20	AWM30 AWD30	AWM40 AWD40
Port size	1/8, 1/4	1/4, 3/8	1/4, 3/8, 1/2
Fluid	Air		
Proof pressure	1.5 MPa		
Maximum operating pressure	1.0 MPa		
Set pressure range	0.05 to 0.85 MPa		
Pressure gauge port size ^{Note 1)}	1/8		1/4
Ambient and fluid temperature ^{Note 2)}	-5 to 60°C (with no freezing)		
Nominal filtration rating	AWM20 to AWM40	0.3 μm (99.9% filtered particle size)	
	AWD20 to AWD40	0.01 μm (99.9% filtered particle size)	
Outlet side oil mist concentration	AWM20 to AWM40	Max. 1.0 mg/m ³ (ANR) (\approx 0.8 ppm) ^{Note 3) Note 4)}	
	AWD20 to AWD40	Max. 0.1 mg/m ³ (ANR) (Before saturated with oil 0.01 mg/m ³ (ANR) or less = 0.008 ppm) ^{Note 3) Note 4)}	
Rated flow (L/min (ANR)) ^{Note 5)}	AWM20 to AWM40	150	330
	AWD20 to AWD40	90	180
Drain capacity (cm ³)	AWM20 to AWM40	8	25
	AWD20 to AWD40	8	25
Bowl material	Polycarbonate		
Bowl guard	Semi-standard	Standard	
Construction	Relieving type		
Weight (kg)	0.29	0.59	0.75

Note 1) Pressure gauge connection threads are not available for

F.R.L. unit with a square embedded type pressure gauge.

Note 2) -5 to 50°C for the products with the digital pressure switch.

Note 3) When the compressor oil mist discharge concentration is 30 mg/m³ (ANR).

Note 4) Bowl O-ring and other O-rings are slightly lubricated.

Note 5) Conditions: Mist separator inlet pressure: 0.7 MPa; outlet pressure: 0.5 MPa. The rated flow varies depending on the inlet pressure. Keep the air flow within the rated flow to prevent an outflow of lubricant to the outlet side.

AWM20 to AWM40 Series AWD20 to AWD40 Series

Options/Part No.

Optional specifications		Model			
		AWM20 AWD20	AWM30 AWD30	AWM40 AWD40	
Bracket assembly ^{Note 1)}		AW20P-270AS	AR30P-270AS	AR40P-270AS	
Set nut		AR20P-260S	AR30P-260S	AR40P-260S	
Pressure gauge	Round type ^{Note 2)}	Standard	G36-10-□01		
		0.02 to 0.2 MPa setting	G36-2-□01		
	Round type ^{Note 2)} (with color zone)	Standard	G36-10-□01-L		
		0.02 to 0.2 MPa setting	G36-2-□01-L		
Square embedded type ^{Note 3)}	Standard	GC3-10AS [GC3P-010AS (Pressure gauge cover only)]			
	0.02 to 0.2 MPa setting	GC3-2AS [GC3P-010AS (Pressure gauge cover only)]			
Digital pressure switch ^{Note 4)}		NPN output / Wiring bottom entry	ISE35-N-25-MLA [ISE35-N-25-M (Switch body only)]		
		NPN output / Wiring top entry	ISE35-R-25-MLA [ISE35-R-25-M (Switch body only)]		
		PNP output / Wiring bottom entry	ISE35-N-65-MLA [ISE35-N-65-M (Switch body only)]		
		PNP output / Wiring top entry	ISE35-R-65-MLA [ISE35-R-65-M (Switch body only)]		
Float type auto drain ^{Note 5) Note 6)}		N.C.	AD27	AD37	AD47
		N.O.	—	AD38	AD48

Semi-standard/Bowl Assembly Part No.

Semi-standard specifications					Model			
Bowl material	Float type auto drain ^{Note 5) Note 6)}		With drain guide ^{Note 6)}	With barb fitting	With bowl guard	AWM20 AWD20	AWM30 AWD30	AWM40 AWD40
	N.C.	N.O.						
Polycarbonate	—	—	—	—	●	C2SF-C	—	—
	●	—	—	—	●	AD27-C	—	—
	—	—	●	—	—	C2SF-J	C3SF-J	C4SF-J
	—	—	—	●	—	—	C3SF-W	C4SF-W
	—	—	●	—	●	C2SF-CJ	—	—
Nylon	—	—	—	—	—	C2SF-6	C3SF-6	C4SF-6
	—	—	—	—	●	C2SF-6C	—	—
	●	—	—	—	—	AD27-6	AD37-6	AD47-6
	—	●	—	—	—	—	AD38-6	AD48-6
	●	—	—	—	●	AD27-6C	—	—
	—	—	●	—	—	C2SF-6J	C3SF-6J	C4SF-6J
	—	—	—	●	—	—	C3SF-6W	C4SF-6W
	—	—	●	—	●	C2SF-6CJ	—	—
Metal	—	—	—	—	—	C2SF-2	C3SF-2	C4SF-2
	●	—	—	—	—	AD27-2	AD37-2	AD47-2
	—	●	—	—	—	—	AD38-2	AD48-2
	—	—	●	—	—	C2SF-2J	C3SF-2J	C4SF-2J
Metal bowl with level gauge	—	—	—	—	—	—	C3LF-8	C4LF-8
	●	—	—	—	—	—	AD37-8	AD47-8
	—	●	—	—	—	—	AD38-8	AD48-8
—	—	●	—	—	—	C3LF-8J	C4LF-8J	

Note 1) Assembly of a bracket and set nuts

Note 2) □ in part numbers for a round pressure gauge indicates a type of connection thread. No indication is necessary for R; however, indicate N for NPT. Please contact SMC regarding the connection thread NPT and pressure gauge supply for psi unit specifications.

Note 3) Including one O-ring and 2 mounting screws. [] : Pressure gauge cover only

Note 4) Lead wire with connector (2 m), adapter, lock pin, O-ring (1 pc.), mounting screw (2 pcs.) are attached. [] : Switch body only.

Also, regarding how to order the digital pressure switch, please refer to page 596.

Note 5) Minimum operating pressure: N.O. type—0.1 MPa; N.C. type—0.1 MPa (AD27) and 0.15 MPa (AD37/47). Please contact SMC for psi and °F unit specifications.

Note 6) Please consult SMC for details on drain piping to fit NPT or G port sizes.

Note) • Including O-ring.

• Bowl assembly for the AWM30/40, AWD30/40 comes with a bowl guard (steel band material). (except when the bowl material is metal)

AWM20 to AWM40 Series

AWD20 to AWD40 Series

Flow Rate Characteristics (Representative values)

Condition: Inlet pressure 0.7 MPa

AWM20 Rc 1/4

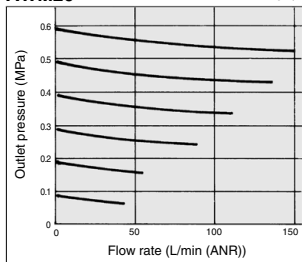

AWM30 Rc 3/8

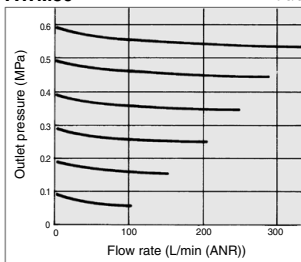

AWM40 Rc 1/2

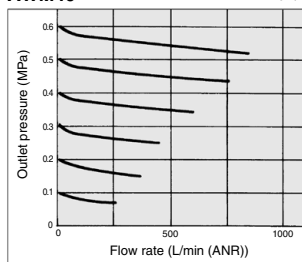

AWD20 Rc 1/4

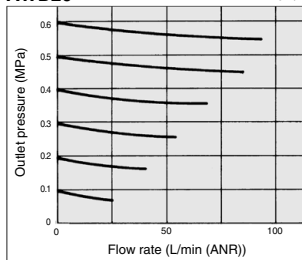

AWD30 Rc 3/8

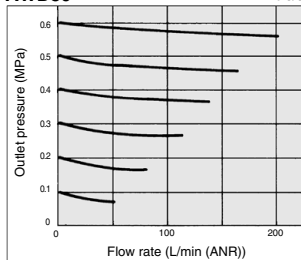

AWD40 Rc 1/2

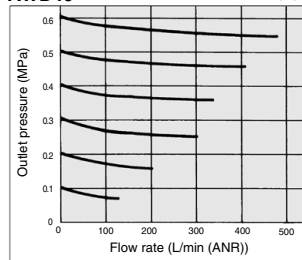

Pressure Characteristics (Representative values)

Conditions: Inlet pressure 0.7 MPa, Outlet pressure 0.2 MPa, Flow rate 20 L/min (ANR)

AWM20

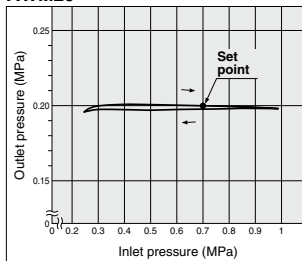

AWM30

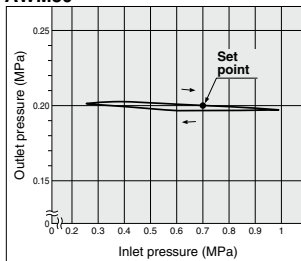

AWM40

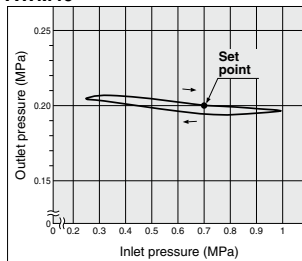

AWD20

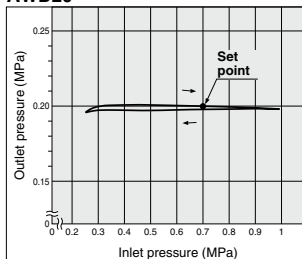

AWD30

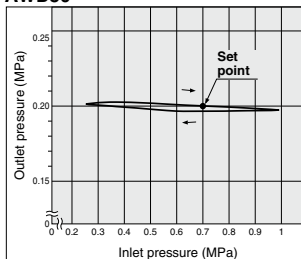

AWD40

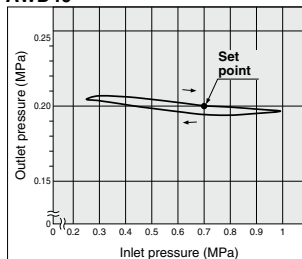

Mist Separator Regulator **AWM20 to AWM40 Series** Micro Mist Separator Regulator **AWD20 to AWD40 Series**

Construction

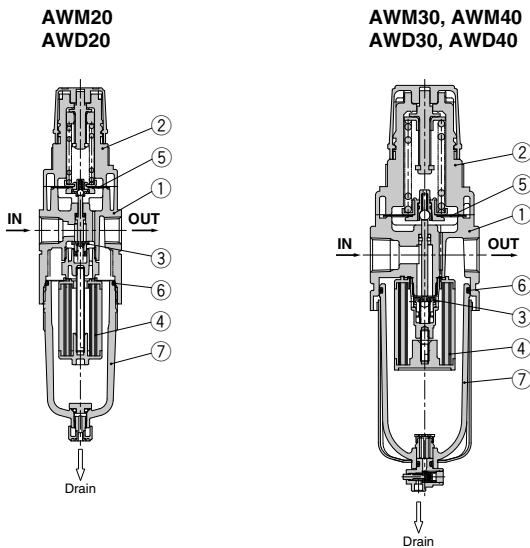

Component Parts

No.	Description	Material	Model	Color
1	Body	Aluminum die-cast	AWM20 to AWM40 AWD20 to AWD40	Platinum silver
2	Bonnet	Polycetal	AWM20 to AWM40 AWD20 to AWD40	Black

Replacement Parts

No.	Description	Material	Part no.		
			AWM20 AWD20	AWM30 AWD30	AWM40 AWD40
3	Valve assembly	Brass, HNBR	AWM20P-090AS	AWM30P-090AS	AWM40P-090AS
4	Element assembly	AWM20 to AWM40	AFM20P-060AS	AFM30P-060AS	AFM40P-060AS
		AWD20 to AWD40	AFD20P-060AS	AFD30P-060AS	AFD40P-060AS
5	Diaphragm assembly	Weatherable NBR	AR20P-150AS	AR30P-150AS	AR40P-150AS
6	Bowl O-ring	NBR	C2SFP-260S	C3SFP-260S	C4SFP-260S
7	Bowl assembly ^{Note 1)}	Polycarbonate	C2SF	C3SF ^{Note 2)}	C4SF ^{Note 2)}

Note 1) Bowl O-ring is included. Please contact SMC regarding the bowl assembly supply for psi and "F unit specifications.

Note 2) Bowl assembly for the AWM30/40, AWD30/40 comes with a bowl guard (steel band material).

AC-A
AF-A
AF□-A
AR-A
AL-A
AW-A
AC-B
AF-A
AF□-A
AR-B
AL-A
AW-B
AW□
A□G
E□
AV
AF

AWM20 to AWM40 Series AWD20 to AWD40 Series

Dimensions

**AWM20
AWD20**

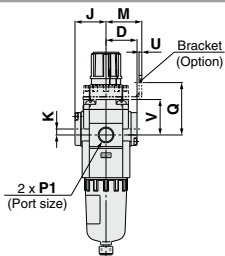
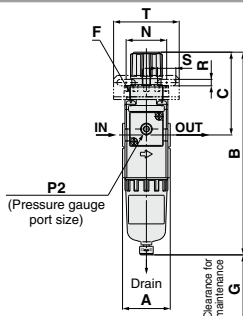

Panel fitting dimension

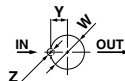
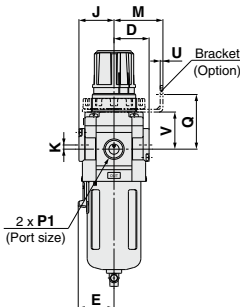
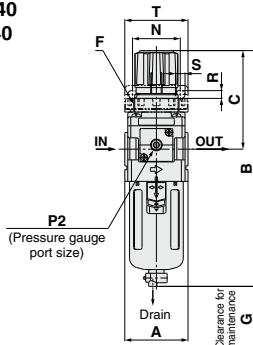

Plate thickness
AWM20, AWD20: Max. 3.5

**AWM30, AWM40
AWD30, AWD40**



Panel fitting dimension

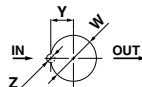
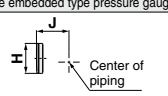
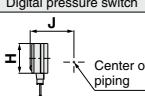
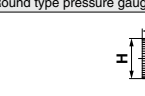
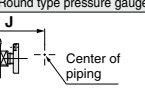
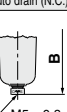
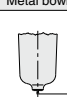
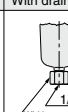
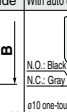
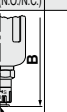
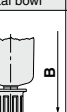
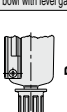
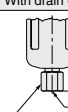



Plate thickness
AWM30, AWD30: Max. 3.5
AWM40, AWD40: Max. 5

Applicable model	AWM20 to AWM40, AWD20 to AWD40			
Option	Square embedded type pressure gauge	Digital pressure switch	Round type pressure gauge	Round type pressure gauge (with color zone)
Dimensions				

Applicable model	AWM20, AWD20				AWM30/40, AWD30/40				
Optional/Semi-standard specifications	With auto drain (N.C.)	Metal bowl	With drain guide	With auto drain (N.O./N.C.)	Metal bowl	Metal bowl with level gauge	With drain guide	Drain cock with barb fitting	
Dimensions									

Model	Standard specifications											Optional specifications							
	P1	P2	A	B (Note)	C	D	E	F	G	J	K	H	J	H	J	H	J		
AWM20/AWD20	1/8, 1/4	1/8	40	173	73	26	—	M28 x 1	40	26	5	□28	27	□27.8	37.5	□37.5	62.5	□37.5	63
AWM30/AWD30	1/4, 3/8	1/8	53	201	86	29.5	30	M38 x 1.5	55	29.5	3.5	□28	30.5	□27.8	41	□37.5	66	□37.5	66
AWM40/AWD40	1/4, 3/8, 1/2	1/4	70	239	92	37.5	38	M42 x 1.5	80	37.5	1.5	□28	38.5	□27.8	49	□42.5	76	□42.5	76

Model	Optional specifications										Semi-standard specifications					
	Bracket mount					Panel mount					With auto drain	With barb fitting		Metal bowl with level gauge		
	M	N	Q	R	S	T	U	V	W	Y	Z	B (Note)	B (Note)	B (Note)	B (Note)	B (Note)
AWM20/AWD20	30	34	44	5.4	15.4	55	2.3	30	28.5	14	6	190	—	177	173	—
AWM30/AWD30	41	40	46	6.5	8	53	2.3	31	38.5	19	7	242	209	208	214	234
AWM40/AWD40	50	54	54	8.5	10.5	70	2.3	35.5	42.5	21	7	278	247	246	252	272

Note) The total length of B dimension is the length when the filter regulator knob is unlocked.

AC-A
AF-A
AF□-A
AR-A
AL-A
AW-A
AC-B
AF-A
AF□-A
AR ^A _B
AL-A
AW ^B
AW□
A□G
E□
AV
AF

Mist Separator Regulator **AWM20 to AWM40 Series** Micro Mist Separator Regulator **AWD20 to AWD40 Series**

- AC-A
- AF-A
- AF□-A
- AR-A
- AL-A
- AW-A
- AC-B
- AF-A
- AF□-A
- AR-B
- AL-A
- AW-B
- AW□
- AG
- E□
- AV
- AF

0.4 MPa Setting
Long Bowl

		Symbol	Description	①			①					
				Body size			Body size					
				20	30	40	20	30	40			
5	Semi-standard	d	Note 6) Set pressure	Nil 1	0.05 to 0.85 MPa setting 0.05 to 0.2 MPa setting	-	-	-	●	●	●	
				+			-	-	-	●	●	●
		e	Bowl	Note 8)	Nil	Polycarbonate bowl	●	●	●	●	●	●
					2	Metal bowl	●	●	●	●	●	●
					6	Nylon bowl	●	●	●	●	●	●
					8	Metal bowl with level gauge	-	●	●	-	-	-
					C	With bowl guard	●	-	-	●	-	-
		6C	Nylon bowl with bowl guard	●	-	-	●	-	-			
				+			-	-	-	●	-	-
		f	Drain port	Note 9)	Nil	With drain cock	●	●	●	●	●	●
					J	Drain guide 1/8	-	-	-	-	-	-
					Note 10)	Drain guide 1/4	-	●	●	-	●	●
					Note 11)	Drain cock with barb fitting: For ø6 x ø4 nylon tube	-	●	●	-	●	●
				+			-	-	-	●	●	●
		g	Exhaust mechanism	Nil	Relieving type	●	●	●	●	●	●	
N	Non-relieving type			●	●	●	●	●	●			
		+			-	-	-	●	●	●		
h	Flow direction	Nil	Flow direction: Left to right	●	●	●	●	●	●			
		R	Flow direction: Right to left	●	●	●	●	●	●			
		+			-	-	-	●	●	●		
i	Pressure unit	Nil	Name plate and caution plate for bowl in imperial units: MPa	●	●	●	●	●	●			
		Z	Name plate and caution plate for bowl, and pressure gauge in imperial units: psi, "F"	○	○	○	○	○	○			
		Note 12)	Digital pressure switch: With unit conversion function	△	△	△	△	△	△			

Note 6) Float type auto drain: when used in combination with C or D, minimum set pressure is: N.O. type-0.1 MPa; N.C. type-0.1 MPa (AD27) and 0.15 MPa (AD37/47).

Note 7) The only difference from the standard specifications is the adjusting spring for the regulator. It does not restrict the setting of 0.2 MPa or more. When the pressure gauge is attached, a 0.2 MPa pressure gauge will be fitted.

Note 8) Refer to Chemical Data on page 387 when selecting a case material.

Note 9) Float type auto drain: The combination of C and D is not possible.

Note 10) Without a valve function

Note 11) Metal bowl: The combination of 2 and 8 is not possible.

Note 12) For thread type: NPT. This product is for overseas use only according to the new Measurement Law. (The SI unit type is provided for use in Japan.) The digital pressure switch will be equipped with the unit conversion function, setting to psi initially.

Note 13) For options: E1, E2, E3, E4. This product is for overseas use only according to the new Measurement Law. (The SI unit is provided for use in Japan.)

Note 14) ○: For thread type: NPT only

Note 15) △: Select with options: E1, E2, E3, E4.

Option Digital Pressure Switch



For details about the Pressure Switch Precautions, refer to Best Pneumatics No. 8.
For details about the Specific Product Precautions, refer to the Operation Manual at SMC website.

ISE35 - **N** - **25** - **M** **L** **A**

① ② ③ ④ ⑤

	Symbol	Description
① Electrical entry	N	Wiring bottom entry
	R	Wiring top entry

② Output	25	NPN output
	65	PNP output
③ Display unit (Note 1)	Nil (Note 2)	With unit conversion function
	M	Fixed SI unit
	P (Note 2)	Pressure unit: psi (initial value) with unit conversion function
④ Lead wire	Nil	Without lead wire
	L	Lead wire (2 m) with connector
⑤ Accessories	Nil	Without accessories (switch body only)
	A	With accessories (adapter, O-ring (1 pc.), mounting screw (2 pcs.), lock pin)

Note 1) Under the New Measurement Law, sales of switches with the unit switching function are not allowed for use in Japan.
Note 2) Name plate is included.
Note 3) Operation Instruction manual is attached.
Note 4) When ordering the body only, select the symbol from ① to ⑤ respectively.

Option/Part no.

When optional parts are required separately, use the following part numbers to place an order.

Part no.	Option
ZS-32-A	Lead wire (2 m) with connector
ZS-32-C	Accessories (adapter, O-ring (1 pc.), mounting screw (2 pcs.), lock pin)

Specifications

Rated pressure range	0 to 1 MPa
Display/Set pressure range	-0.1 to 1 MPa
Withstand pressure	1.5 MPa
Display/Set pressure resolution	0.01 MPa
Fluid	Air, Inert gas, Non-flammable gas
Power supply voltage	12 to 24 VDC, Ripple (p-p) 10% or less (with power supply polarity protection)
Current consumption	55 mA or less (at no load)
Switch output	NPN or PNP open collector 1 output
Max. load current	80 mA
Max. applied voltage	30 V (with NPN output)
Residual voltage	1 V or less (with load current of 80 mA)
Response time	1 s (Response time selections: 0.25, 0.5, 2, 3)
Short circuit protection	With short circuit protection
Repeatability	±1%F.S.
Hysteresis	Hysteresis mode Window comparator mode
	Variable (can be set from 0)
Display	3-digit, 7-segment indicator, 2-color display (Red/Green) can be interlocked with the switch output.
Display accuracy	±2%F.S. ±1 digit (at 25°C ± 3°C)
Indicator light	Illuminates when output is turned ON. (Green)
Environmental resistance	IP40
Operating temperature range	-5 to 50°C (with no freezing and condensation)
Lead wire with connector (Option: L)	ø3.4 3-wire 25AWG 2 m With connector cover
Weight	Approx. 14 g (body only), Approx. 38 g (including lead wire with connector)
Standard	CE, UL, CSA, RoHS

Note) For details about the wiring, refer to the Operation Manual at SMC website (<http://www.smcworld.com>).

Applicable Series

F.R.L. unit	AC20, AC25, AC30, AC40, AC50, AC55, AC60 AC20A, AC30A, AC40A, AC50A, AC60A AC20B, AC25B, AC30B, AC40B, AC50B, AC55B, AC60B AC20C, AC25C, AC30C, AC40C AC20D, AC30D, AC40D
Regulator	AR20(K), AR25(K), AR30(K), AR40(K), AR50(K), AR60(K)
Filter regulator	AW20(K), AW30(K), AW40(K), AW60(K)
Mist separator regulator	AWM20, AWM30, AWM40
Micro mist separator regulator	AWD20, AWD30, AWD40

Digital Pressure Switch Details

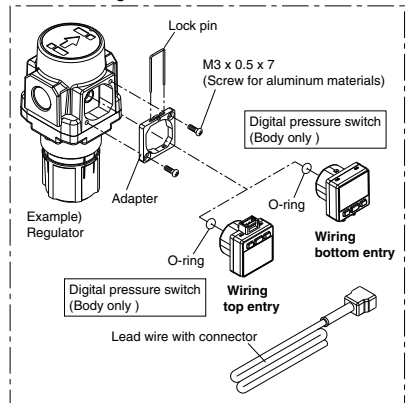

Dimensions: Lead wire with connector

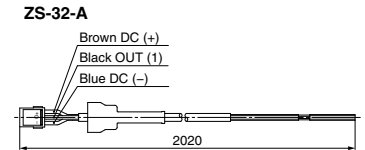

Option Knob Cover

Prevents careless knob operation.

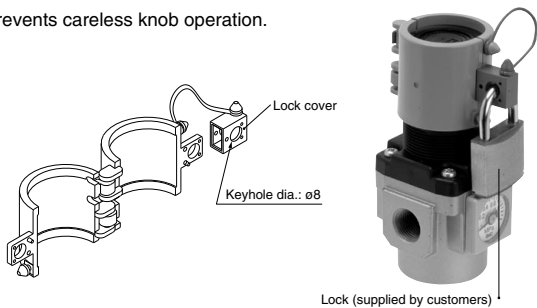

Part no.	Applicable model
AR20P-580AS	AC20□, AR20(K), AW20(K), AWM20, AWD20
AR25P-580AS	AC25□, AR25(K)
AR30P-580AS	AC30□, AR30(K), AW3(K), AWM30, AWD30
AR40P-580AS	AC40□(-06), AR40(K)(-06), AW40(K)(-06), AWM40, AWD40

AC-A

AF-A

AF□-A

AR-A

AL-A

AW-A

AC-B

AF-A

AF□-A

AR-B

AL-A

AW-B

AW□

A□G

E□

AV

AF