

Clamping cartridges/units

FESTO



Characteristics

At a glance

- The clamping cartridges/units use spring force to hold round material in any required position.
- They can stop and hold material for long periods, even in applications with varying loads, fluctuating operating pressure and system leaks.
- The clamping force is released by pressurising the clamping cartridge.
- The clamping cartridges/units can be mounted in any position.
- Clamping cartridges/units are not suitable for positioning.
- The clamping cartridge KP and the clamping units KPE, KEC, KEC-S are standalone components.
- Cylinders with integrated clamping unit
 - ADNKP
 - DSNU-...-KP
 - DSBC-...-C
 - DNCKE/DNCKE-S
- Zero backlash in clamped condition with varying loads on the piston rod:
 - Clamping cartridge/unit KP/KPE: no
 - Clamping unit KEC/KECS: yes

Selection aid

Clamping cartridge KP → Page 6



- For in-house assembly of clamping units
- Not certified for use in safety-related control systems

Clamping unit KPE → Page 8



- Ready-to-install combination of clamping cartridge KP and housing
- Wide range of mounting options → 9
- Not certified for use in safety-related control systems

Clamping unit KEC → Page 10



- For use as a holding device (static application):
 - Holding and clamping in the event of power failure
 - Protection against pressure failure and pressure drop
 - Securing the piston rod during intermediate stops for process operations
- Mounting hole pattern to ISO 15552 (DIN ISO 6431)
- Not certified for use in safety-related control systems

Clamping unit KEC-...-S, for safety-related applications → Page 12



- Pneumatic braking/holding device for use in safety-related parts of control systems.
The clamping unit is not a complete safety solution, but it can be used as part of a solution.
- Certified by the Institute for Occupational Safety and Health of the German Social Accident Insurance (DGUV). Testing and certification body in DGUV Test (IFA). Pneumatic braking/holding device with safety function.
- For use as a holding device (static application):
 - Holding and clamping in the event of power failure
 - Protection against pressure failure and pressure drop
 - Securing the piston rod during intermediate stops for process operations
- For use as a braking device (dynamic application):
 - Braking or stopping a movement
 - Suspension of a movement if a danger zone is entered
- Mounting hole pattern to ISO 15552 (DIN ISO 6431)
- When used as a braking device, the overtravel must be checked regularly
- Suitable for use in safety-related parts of control systems belonging to category 1 to EN ISO 13849-1 (tried-and-tested component). Additional control measures are required for use in higher categories.
- Products intended for use in safety-related applications must be selected, sized and arranged in accordance with valid standards and regulations.

Characteristics

Requirements for the round material to be clamped

In combination with clamping cartridge KP or clamping unit KPE

- | | | | |
|---|--|--|---|
| <ul style="list-style-type: none"> • Material: <ul style="list-style-type: none"> – Hard-chrome-plated steel – Hardened steel – Rolled steel: <ul style="list-style-type: none"> Tensile strength $> 650 \text{ N/mm}^2$, hardness (HB30) > 175 | <ul style="list-style-type: none"> • Diameter tolerance: h8 • Surface roughness: <ul style="list-style-type: none"> $R_{\text{max.}} = 4 \text{ }\mu\text{m}$ | <ul style="list-style-type: none"> • The specified holding forces refer to a static load. If these values are exceeded, slippage may occur. | <ul style="list-style-type: none"> • Clamping cartridge KP and clamping unit KPE are not suitable for dynamic operation. |
|---|--|--|---|

In combination with clamping unit KEC

- | | | | |
|--|---|--|--|
| <ul style="list-style-type: none"> • Material: <ul style="list-style-type: none"> – Hard-chrome-plated steel: <ul style="list-style-type: none"> layer thickness min. $20 \text{ }\mu\text{m}$ – Hardened steel: <ul style="list-style-type: none"> min. HRC 60 | <ul style="list-style-type: none"> • Diameter tolerance: h7 ... f7 • Surface roughness: <ul style="list-style-type: none"> $R_{\text{max.}} = 4 \text{ }\mu\text{m}$ | <ul style="list-style-type: none"> • The specified holding forces refer to a static load. If these values are exceeded, slippage may occur. | <ul style="list-style-type: none"> • Clamping unit KEC is not suitable for dynamic operation. • For clamping unit KECS, the following applies: dynamic forces occurring during operation must not exceed the static holding force. |
|--|---|--|--|

Type codes

001	Series
KP	Clamping cartridge

002	Piston rod diameter [mm]
4	4
6	6
8	8
10	10
12	12
16	16
20	20
25	25
32	32

003	Static holding force
80	80
180	180
350	350
600	600
1000	1000
1400	1400
2000	2000
5000	5000
7500	7500

Type codes

001	Series	
KPE	Clamping unit	
KEC	Clamping unit	



002	Piston rod diameter [mm]	
4	4	
6	6	
8	8	
10	10	
12	12	
16	16	
20	20	
25	25	
32	32	

003	Certification	
	None	
S	Safety device to Machinery Directive 2006/42/EC	

Data sheet

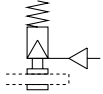
Function



-  - Diameter of round material to be clamped: 4 ... 32 mm
-  - Force 80 ... 7500 N



- - Note

Additional measures are required for use in safety-related applications; in Europe, for example, the standards listed under the EC Machinery Directive must be observed. Without additional measures in accordance with statutory minimum requirements, the product is not suitable as a safety-related part of control systems.

General technical data

For round material diameter	4	6	8	10	12	16	20	25	32	
Pneumatic connection	M5					G1/8				
Design	Tilting plates									
Type of mounting	Via self-configured housing									
Type of clamping with active direction	At both ends									
	Clamping via spring force, compressed air to release									
Static holding force [N]	80	180	350	350	600	1000	1400	2000	5000	7500
Axial play under load [mm]	0.2	0.3		0.5			0.8			1.8
Min. release pressure [MPa]	0.3									
	[bar] 3									
Mounting position	Any									
Product weight [g]	10	15	50	50	50	90	170	170	700	1600

Operating and environmental conditions

Operating medium	Compressed air to ISO 8573-1:2010 [7:4:4]
Note on operating/pilot medium	Lubricated operation possible (in which case lubricated operation will always be required)
Operating pressure [bar]	≤ 10
Ambient temperature [°C]	-10 ... +80
Corrosion resistance CRC ¹⁾	2

1) Corrosion resistance class CRC 2 to Festo standard FN 940070

Moderate corrosion stress. Indoor applications in which condensation can occur. External visible parts with primarily decorative surface requirements which are in direct contact with a normal industrial environment.

Materials

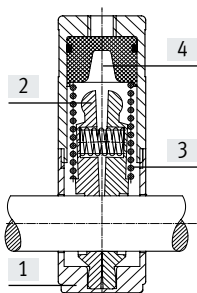

Sectional view



Clamping cartridge		
[1]	Housing	Anodised aluminium
[2]	Clamping jaws	Brass
[3]	Spring	Spring steel
[4]	Piston	POM
-	Seals	NBR, TPE-U(PU)

Data sheet

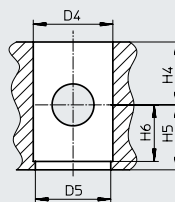
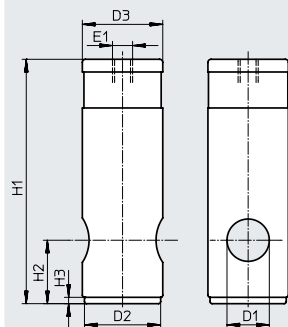
Dimensions and ordering data

Download CAD data → www.festo.com
 **Note**

When installing the clamping cartridge in a housing, plain bearings must be installed on both sides of this housing.

For diam. [mm]	D1 ∅	D2 ∅ h12	D3 ∅ f9	D4 ∅ D9	D5 ∅	E1	H1	H2
4	4	10	12	12	11	M5	28	7
6	6	14	16	16	15	M5	35	10
8	8	18	20	20	19	M5	62	17.5
10	10	18	20	20	19	M5	62	17.5
12	12	18	20	20	19	M5	62	17.5
16	16	22	24	24	23	G1/8	83	22
20	20	28	30	30	29	G1/8	100	25
	20	36	38	38	37	G1/8	115.5	30
25	25	46	48	48	47	G1/8	155	36
32	32	63	65	65	64	G1/8	195	55

For diam. [mm]	H3	H4 min.	H5 min.	H6	Weight [g]	Part no.	Type
4	2	9	7.5	6	10	178452	KP-4-80
6	3	10	11	8	15	178453	KP-6-180
8	3	18	18.5	15.5	50	178454	KP-8-350
10	3	18	18.5	15.5	50	178455	KP-10-350
12	3	18	18.5	15.5	50	178456	KP-12-600
16	3	22	23	20	90	178457	KP-16-1000
20	3	25	26	23	170	178458	KP-20-1400
	3	30	31	28	170	178459	KP-20-2000
25	3	36	37	34	700	178460	KP-25-5000
32	3	55	56	53	1600	178461	KP-32-7500

Data sheet

Function

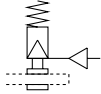

-  - Diameter of round material to be clamped: 4 ... 32 mm

-  - Force 80 ... 7500 N

-  - www.festo.com



- - Note

Additional measures are required for use in safety-related applications; in Europe, for example, the standards listed under the EC Machinery Directive must be observed. Without additional measures in accordance with statutory minimum requirements, the product is not suitable as a safety-related part of control systems.

General technical data

For round material diameter	4	6	8	10	12	16	20	25	32	
Pneumatic connection	M5					G1/8				
Design	Tilting plates									
Type of mounting	With mounting thread									
	With through-hole									
Type of clamping with active direction	At both ends									
	Clamping via spring force, compressed air to release									
Static holding force [N]	80	180	350	350	600	1000	2000	5000	7500	
Axial play under load [mm]	0.2	0.3		0.5			0.8		1.8	
Min. release pressure [MPa]	0.3									
	[bar] 3									
Mounting position	Any									
Product weight [g]	100	150	240	260	270	410	930	2000	4600	

Operating and environmental conditions

Operating medium	Compressed air to ISO 8573-1:2010 [7:4:4]
Note on operating/pilot medium	Lubricated operation possible (in which case lubricated operation will always be required)
Operating pressure [bar]	≤ 10
Ambient temperature [°C]	-10 ... +80
Corrosion resistance CRC ¹⁾	2

1) Corrosion resistance class CRC 2 to Festo standard FN 940070

Moderate corrosion stress. Indoor applications in which condensation can occur. External visible parts with primarily decorative surface requirements which are in direct contact with a normal industrial environment.

Materials

Sectional view

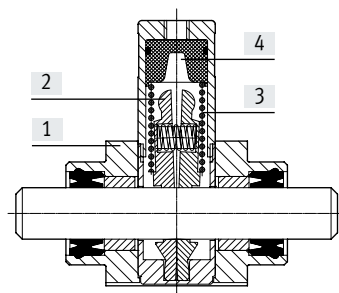

Clamping unit		
[1]	Retaining bracket	Anodised aluminium
[2]	Clamping jaws	Brass
[3]	Spring	Spring steel
[4]	Piston	POM
-	Seals	NBR, TPE-U(PU)

Data sheet

Mounting options

With mounting thread

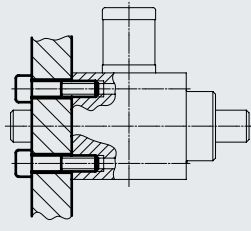
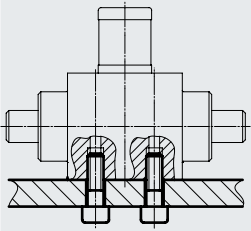

With through-hole

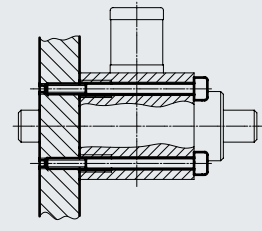
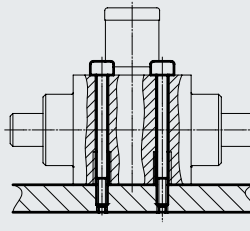

Dimensions and ordering data

For round material diameter 4 ... 6 mm

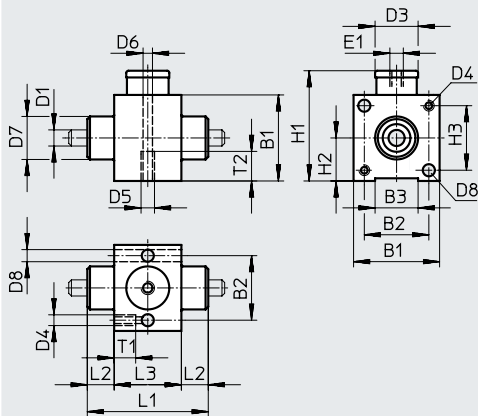

For round material diameter 8 ... 32 mm

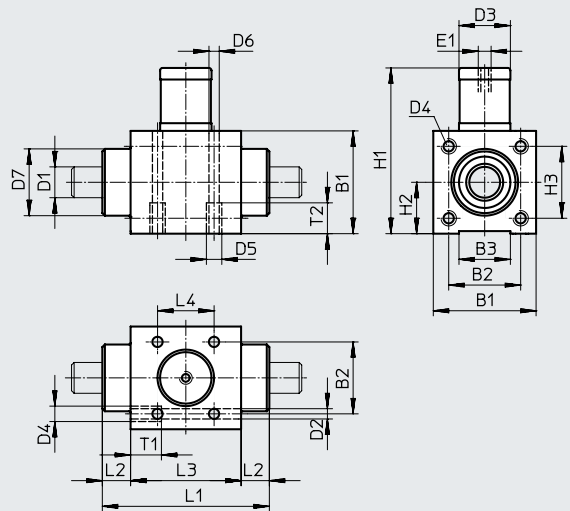
Download CAD data → www.festo.com



For diam.	B1	B2	B3	D1 ∅	D2 ∅	D3 ∅	D4	D5	D6 ∅	D7 ∅ d11	D8 ∅	E1	H1	H2
[mm]														
4	27	19.5	12	4	–	12	–	M5	4.2	12	4.5	M5	34.5	13.5
6	32	24	16	6	–	16	–	M5	4.2	16	4.5	M5	41	16
8	36	27	20	8	4.2	20	M5	M5	4.2	22	–	M5	62.5	18
10	36	27	20	10	4.2	20	M5	M5	4.2	22	–	M5	62.5	18
12	40	28	20	12	5.2	20	M6	M6	5.2	28	–	M5	64.5	20
16	45	32.5	25	16	5.2	24	M6	M6	5.2	32	–	G1/8	83.5	22.5
20	65	50	38	20	6.5	38	M8	M8	6.5	45	–	G1/8	118	32.5
25	88	65	50	25	8.5	48	M10	M10	8.5	55	–	G1/8	163	44
32	118	90	70	32	10.3	65	M12	M12	10.3	60	–	G1/8	199	59

For diam.	H3	L1	L2	L3	L4	T1	T2	Weight	Part no.	Type
[mm]								[g]		
4	19.5	33	7.5	18	–	9	11	100	178462	KPE-4
6	24	45	10	25	–	9	11	150	178463	KPE-6
8	27	58	10	38	20	10	11	240	178464	KPE-8
10	27	62	12	38	20	10	11	260	178465	KPE-10
12	28	65	11	43	22	12	12	270	178466	KPE-12
16	32.5	69	12.5	44	22	12	12	410	178467	KPE-16
20	50	83	12.5	58	30	16	16	930	178468	KPE-20
25	65	100	15	70	34	20	20	2000	178469	KPE-25
32	90	154	25	104	60	24	24	4600	178470	KPE-32

Data sheet

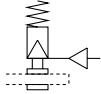
Function



-  - Diameter of round material to be clamped: 16 ... 25 mm
-  - Force 1300 ... 8000 N

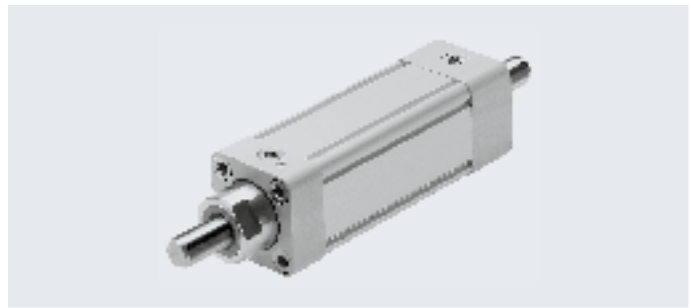

-  - **Note**
 Additional measures are required for use in safety-related applications; in Europe, for example, the standards listed under the EC Machinery Directive must be observed. Without additional measures in accordance with statutory minimum requirements, the product is not suitable as a safety-related part of control systems.

General technical data			
For round material diameter	16	20	25
Pneumatic connection	G1/8	G1/4	G3/8
Type of mounting	With female thread With accessory → page 14		
Type of clamping with active direction	At both ends Clamping via spring force, compressed air to release		
Static holding force	1300	3200	8000
Min. release pressure	[MPa] 0.38 [bar] 3.8		
Mounting position	Any		
Product weight	[g] 1860	4515	16760

Operating and environmental conditions	
Operating medium	Compressed air to ISO 8573-1:2010 [7:4:4]
Note on operating/pilot medium	Lubricated operation possible (in which case lubricated operation will always be required)
Operating pressure	[bar] 3.8 ... 10
Ambient temperature	[°C] -20 ... +80
ATEX	Selected types → www.festo.com
Requirements for the round material	
Tolerance	h7 ... f7
Quality	Hardened (min. HRC 60) or hard-chrome-plated (layer thickness min. 20 µm) Surface roughness Rmax. = 4 µm
Lead-in chamfer	3 mm wide 15° chamfer on the end of the round material

-  - **Note**
 The specified holding force refers to a static load. If this value is exceeded, slippage may occur. Dynamic forces occurring during operation must not exceed the static holding force if slippage is to be avoided. The clamping unit is backlash-free in the clamped condition when varying loads are applied to the piston rod. Lateral loads and bending moments on the round material can impair the function. (Make sure that the load on the round material is only in the direction of movement.)

Actuation:
 The clamping unit may only be released when the forces on the round material are balanced out. Otherwise there is a risk of accidents due to the sudden movement of the round material. Blocking off the compressed air supply at both ends (e.g. with a 5/3-way valve) does not provide any safety.

Data sheet

Materials

Sectional view

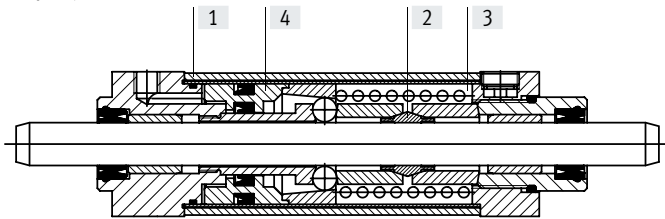

Clamping unit

[1]	Housing	Wrought aluminium alloy
[2]	Clamping jaws	Tool steel
[3]	Spring	High-alloy steel
[4]	Piston	Wrought aluminium alloy
-	Seals	NBR, TPE-U(PU)

Dimensions and ordering data

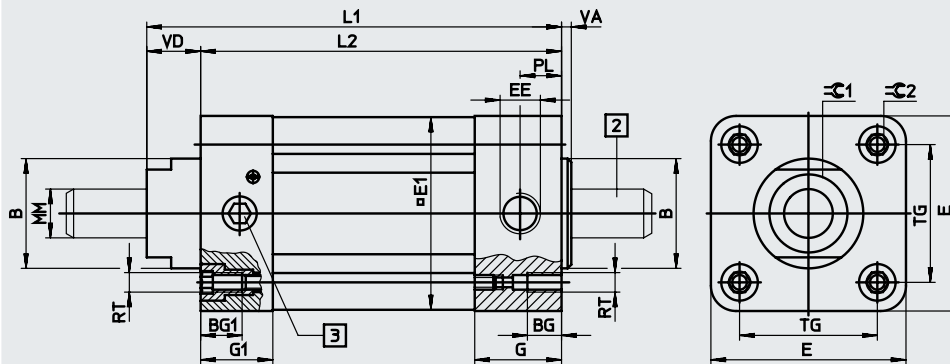
Download CAD data → www.festo.com

-  - **Note**

The clamping unit can only be exhausted when it contains round material.

- [2] Round material to be clamped
- [3] Locking screw



For diam. [mm]	B ∅ f8	BG	BG1	E	E1	EE	G	G1	L1	L2	MM ∅ f7-h7
16	35	15	15	54	53	G1/8	27	22	178	160	16
20	45	14	17	80	79	G1/4	30	29.5	208.5	187	20
25	55	17	17	126	126	G3/8	32.5	32.5	287	258	25

For diam. [mm]	PL	RT	TG	VA	VD	≙C1	≙C2	Weight [g]	Part no.	Type
16	13	M6	38	5.5	18	30	6	1860	527492	KEC-16
20	15.5	M8	56.5	6	21.5	36	8	4515	527493	KEC-20
25	17	M10	89	7	29	41	10	15600	527494	KEC-25

Data sheet

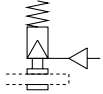
Function



-  Diameter of round material to be clamped: 16 ... 25 mm
-  Force 1300 ... 8000 N

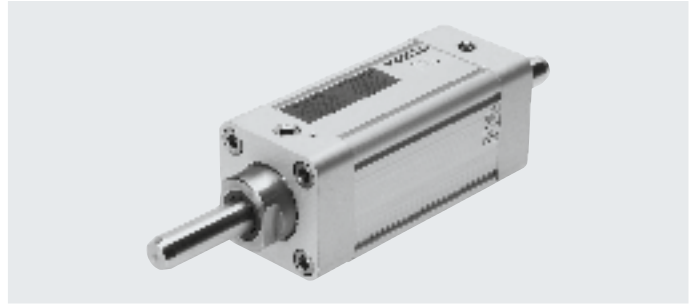

General technical data				
For round material diameter		16	20	25
Pneumatic connection		G1/8	G1/4	G3/8
Type of mounting		With female thread		
		With accessory → page 14		
Type of clamping with active direction		At both ends		
		Clamping via spring force, compressed air to release		
Static holding force		1300	3200	8000
Min. release pressure	[MPa]	0.38		
	[bar]	3.8		
Mounting position		Any		
Function		Single-channel to EN ISO 13849-1, category 1		
Safety function		Holding and stopping a movement		
Certification		Certified by the Institute for Occupational Safety and Health of the German Social Accident Insurance (DGUV). Testing and certification body in DGUV Test (IFA)		
Product weight	[g]	1860	4515	15600

Operating and environmental conditions	
Operating medium	Compressed air to ISO 8573-1:2010 [7:4:4]
Note on operating/pilot medium	Lubricated operation possible (in which case lubricated operation will always be required)
Operating pressure	[bar] 3.8 ... 8
Max. permissible test pressure	[bar] 10
Ambient temperature	[°C] -10 ... +60
Requirements for the round material	
Tolerance	h7 ... f7
Quality	Hardened (min. HRC 60) or hard-chrome-plated (layer thickness min. 20 µm)
	Surface roughness Rmax. = 4 µm
Lead-in chamfer	3 mm wide 15° chamfer on the end of the round material

-  Note
The specified holding force refers to a static load. If this value is exceeded, slippage may occur. Dynamic forces occurring during operation must not exceed the static holding force if slippage is to be avoided. The clamping unit is backlash-free in the clamped condition when varying loads are applied to the piston rod. Lateral loads and bending moments on the round material can impair the function. (Make sure that the load on the round material is only in the direction of movement.)

Actuation:
The clamping unit may only be released when the forces on the round material are balanced out. Otherwise there is a risk of accidents due to the sudden movement of the round material. Blocking off the compressed air supply at both ends (e.g. with a 5/3-way valve) does not provide any safety.

Safety data	
Safety function	Stopping a linear movement
Performance Level (PL)	Cat. 1, PLc
Certificate issuing authority	IFA 1504155
CE marking (see declaration of conformity)	To EU Machinery Directive

Data sheet

Materials

Sectional view

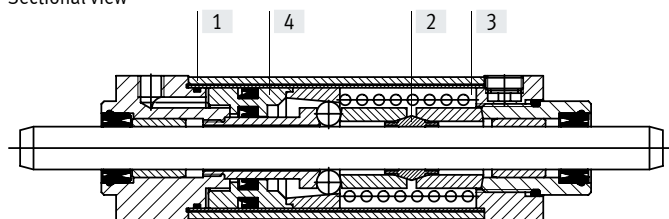

Clamping unit

[1]	Housing	Wrought aluminium alloy
[2]	Clamping jaws	Tool steel
[3]	Spring	High-alloy steel
[4]	Piston	Wrought aluminium alloy
-	Seals	NBR, TPE-U(PU)

Dimensions and ordering data

KEC-S – for safety-related control systems

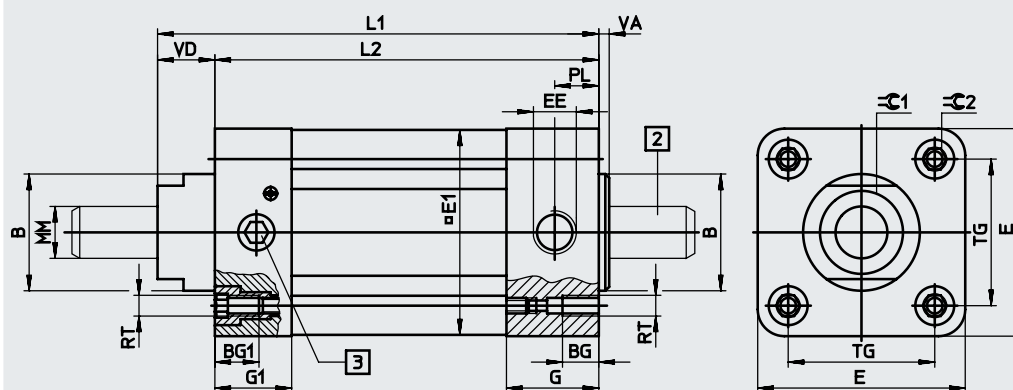
Download CAD data → www.festo.com-  - **Note**

The clamping unit can only be exhausted when it contains round material.

- [2] Round material to be clamped
- [3] Locking screw

For diam.	B	BG	BG1	E	E1	EE	G	G1	L1	L2	MM
[mm]	∅ f8										∅ f7-h7
16	35	15	15	54	53	G1/8	27	22	178	160	16
20	45	14	17	80	79	G1/4	30	29.5	208.5	187	20
25	55	17	17	126	126	G3/8	32.5	32.5	287	258	25

For diam.	PL	RT	TG	VA	VD	∅C1	∅C2	Weight	Part no.	Type
[mm]								[g]		
16	13	M6	38	5.5	18	30	6	1860	538242	KEC-16-S
20	15.5	M8	56.5	6	21.5	36	8	4515	538243	KEC-20-S
25	17	M10	89	7	29	41	10	15600	538244	KEC-25-S

-  - **Note**

The overtravel is the distance that the piston rod covers between exhausting of the clamping unit and coming to a standstill. It must be determined by the customer when the machine is being set up. When the clamping unit is used as a braking device, an increase in the overtravel as a function of the load and the frequency of braking (wear) must be expected. The clamping unit KEC-S can be used in safety-related parts of control systems belonging to category 1 (tried-and-tested component) as defined by EN ISO 13849-1. For use in higher categories than category 1 to EN ISO 13849-1, the overtravel must be achieved even in the event of faults.

The overtravel is dependent on the ambient conditions and stress, e.g.:

- Operating pressure
- Nominal size of the switching valve
- Cable length
- Diameter of the connecting cable to the clamping unit
- Load and speed

The overtravel can be reduced by attaching a quick exhaust valve to the compressed air supply port of the clamping unit.

Clamping units

Accessories

Foot mounting HNC

Material:
Galvanised steel
Free of copper and PTFE

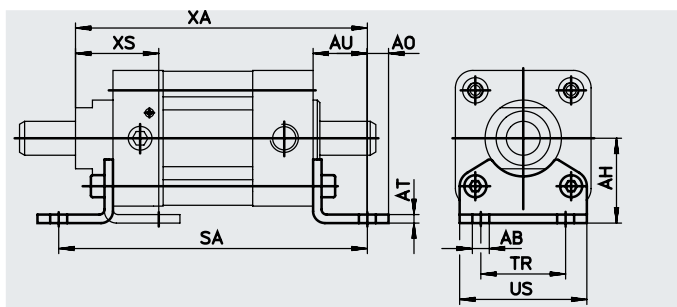

Dimensions and ordering data

For diam.	AB ∅	AH	AO	AT	AU	SA	TR	US	XA	XS	CRC ¹⁾	Weight [g]	Part no.	Type
[mm]														
16	10	36	9	5	28	216	36	54	206	42	2	193	174370	HNC-40
20	10	50	12.5	6	32	251	50	75	240.5	48.5	2	436	174372	HNC-63
25	14.5	71	17.5	6	41	340	75	110	328	64	2	1009	174374	HNC-100

1) Corrosion resistance class CRC 2 to Festo standard FN 940070

Moderate corrosion stress. Indoor applications in which condensation can occur. External visible parts with primarily decorative surface requirements which are in direct contact with a normal industrial environment.

Flange mounting FNC

Material:
Galvanised steel
Free of copper and PTFE

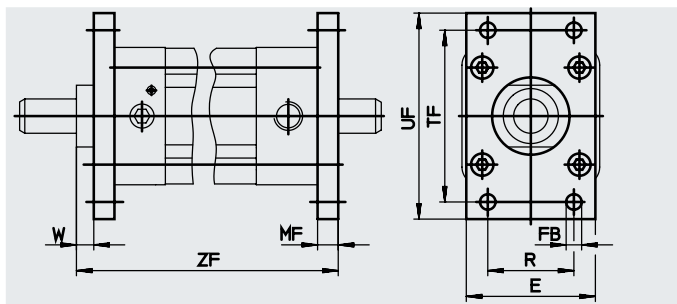

Dimensions and ordering data

For diam.	E	FB ∅ H13	MF	R	TF	UF	W	ZF	CRC ¹⁾	Weight [g]	Part no.	Type
[mm]												
16	54	9	10	36	72	90	8	188	1	291	174377	FNC-40
20	75	9	12	50	100	120	9.5	220.5	1	679	174379	FNC-63
25	110	14	16	75	150	175	13	303	1	2041	174381	FNC-100

1) Corrosion resistance class CRC 1 to Festo standard FN 940070

Low corrosion stress. Dry internal application or transport and storage protection. Also applies to parts behind coverings, in the non-visible interior area, and parts which are covered in the application (e.g. drive trunnions).