

Valve terminals VTSA

FESTO

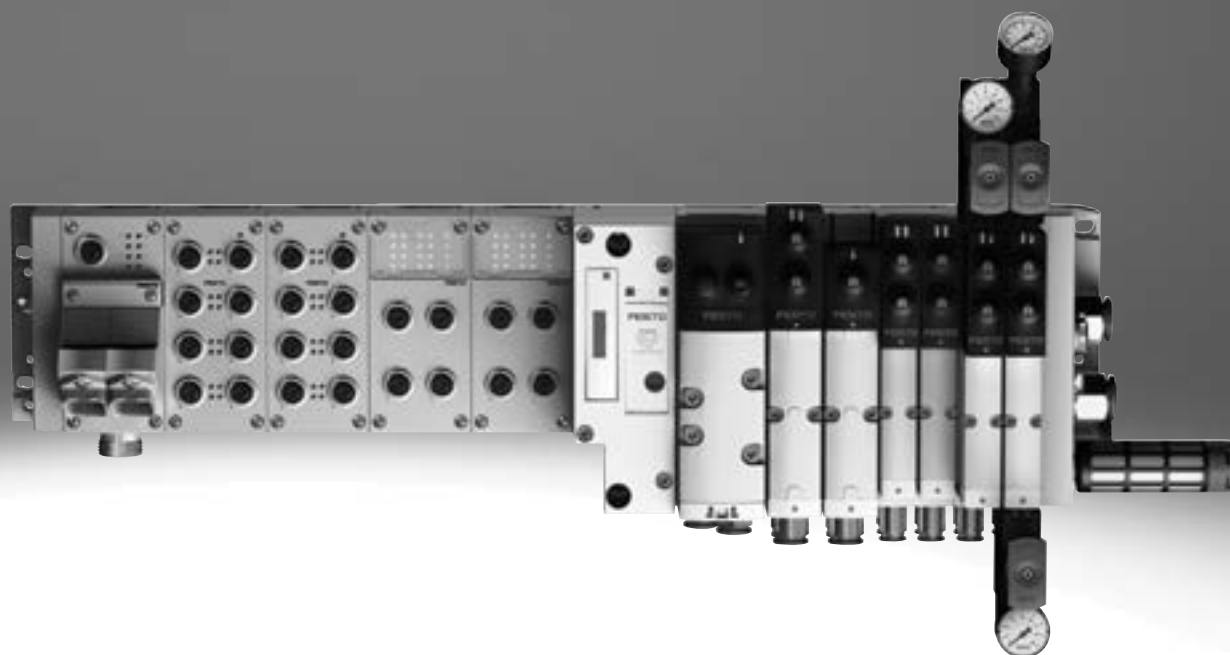

Key features

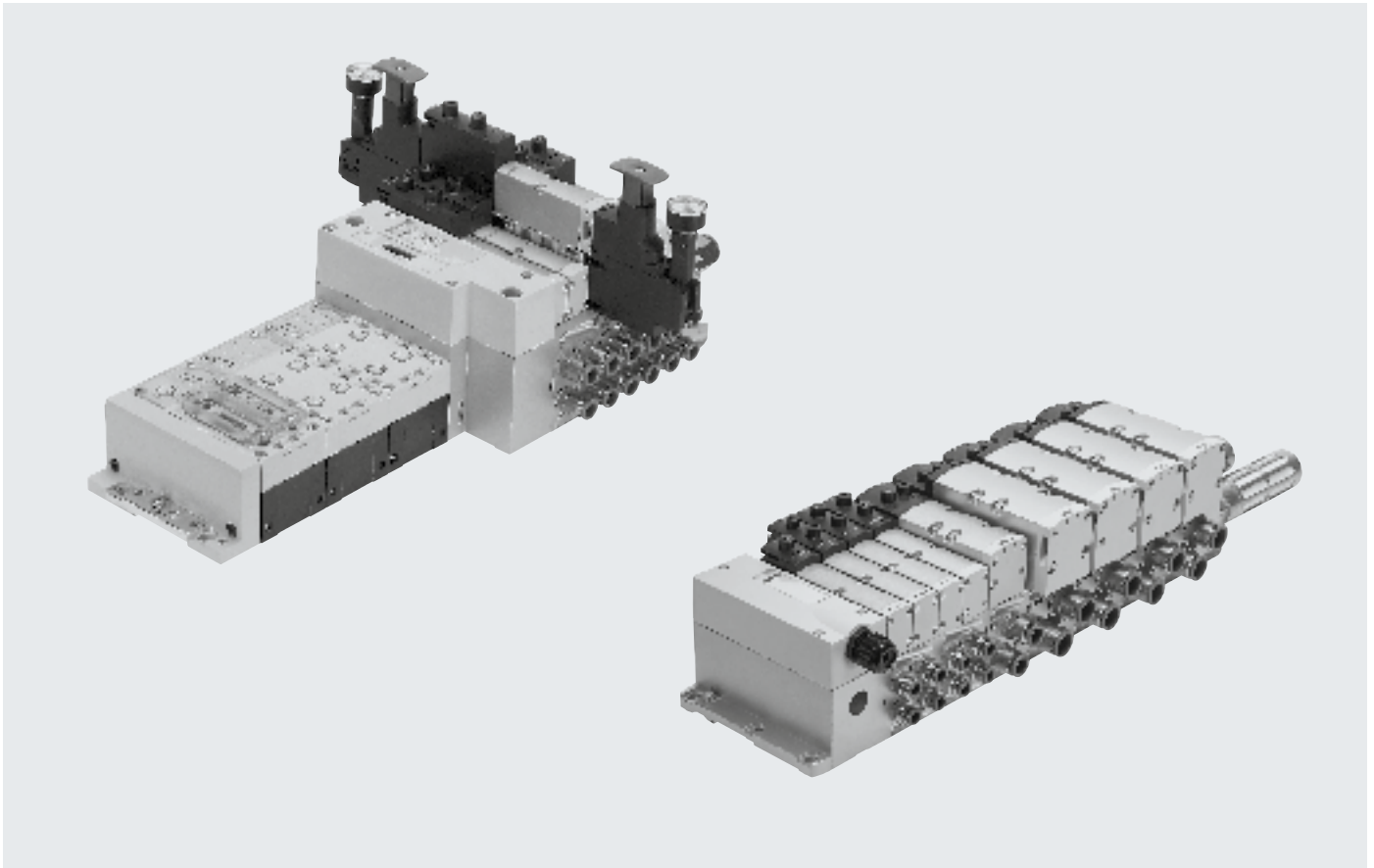

Innovative

- High-performance valves in a sturdy metal housing
- Five valve sizes on one valve terminal (width 65 mm with adapter)
- Standardised from the multi-pin plug to the fieldbus connection and control block
- Dream team: fieldbus valve terminal suitable for electrical peripherals CPX. This means:
 - Forward-looking internal communication system for actuating the valves and CPX modules
 - Four valve sizes on one valve terminal without adapters
 - Integration of smart valve functions with VTSA-F-CB
- Valve functions for integration in control architectures of higher categories to EN ISO 13849-1

Flexible

- Modular system offering a range of configuration options
- Up to 32 solenoid coils
- Conversions and extensions are possible at any time
- Integration of innovative function modules possible
- Flexible air supply and variable pressure zones
- Reverse operation
- High pressure range
- –0.9 ... 10 bar, flow rate range 550 ... 4000 l/min
- Wide range of valve functions
- Valves: 24 V DC

Valve terminal VTSA-F-CB

- Serial communication in the pneumatic part
- A maximum of 7 voltage zones (6 of which via Profisafe shut-off module and one additional voltage zone via Uval)
- Up to 24 solenoid coils per voltage zone
- Up to 96 valve positions and up to 64 interlinking blocks per valve terminal

Reliable

- Sturdy and durable metal components
 - Valves
 - Manifold sub-bases
 - Seals
- Fast troubleshooting with LEDs on the valves and diagnostics via fieldbus
- Reliable servicing thanks to valves that can be replaced quickly and easily
- Manual override, either non-detenting, non-detenting/detenting or concealed
- Durable thanks to tried-and-tested piston spool valves
- Large and durable labelling system
- 100% duty cycle

Easy to install

- Ready-to-install and tested unit
- Reduced costs for selection, ordering, assembly and commissioning
- Secure mounting on a wall or H-rail
- Manifold sub-bases can be extended using four screws, sturdy duct separation on metal support

Key features

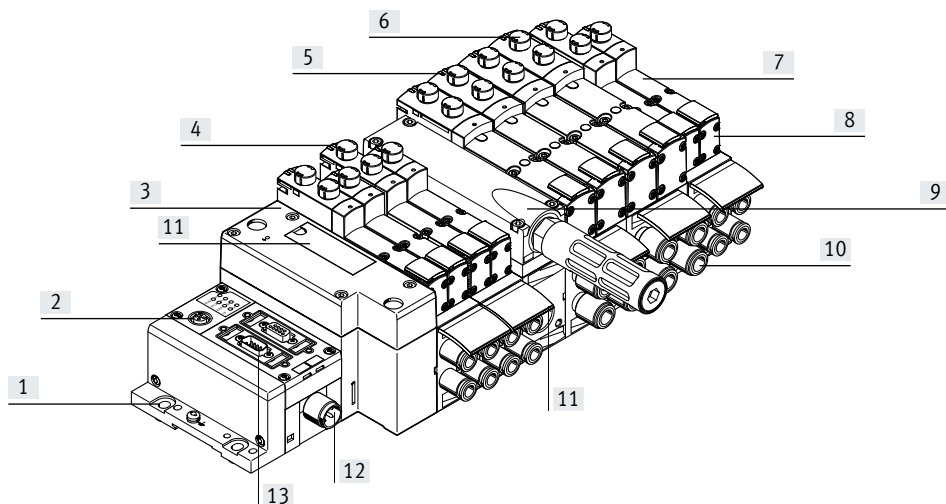

- | | | | |
|--|--|--|--|
| <p>[1] Quick to mount: directly using screws or H-rail</p> <p>[2] CPX diagnostic interface for handheld devices (channel-oriented diagnostics down to the individual valve)</p> <p>[3] Pneumatic interface to CPX</p> <p>[4] Widths 18 mm, 26 mm, 42 mm and 52 mm can be combined on one valve terminal without an adapter</p> | <p>[5] Reduced downtimes: on-site LED diagnostics</p> <p>[6] Safe operation: manual override non-detenting, non-detenting/concealed</p> <p>[7] Versatile: 32 valve positions/32 solenoid coils
One valve series for a wide range of flow rates</p> <p>[8] Comprehensive range of valve functions</p> | <p>[9] Modular: air supply plate facilitates the creation of multiple pressure zones as well as numerous additional exhaust and supply ports</p> <p>[10] Practical: large connections, flow-optimised ducts, sturdy metal threads or pre-assembled push-in connections for compressed air tubing with standardised O.D.</p> <p>[11] Convenient: large inscription labels</p> | <p>[12] Reliable: valves, outputs and logic voltage can be switched off separately</p> <p>[13] Simple electrical connections</p> <ul style="list-style-type: none"> – Fieldbus interface via CPX – Multi-pin plug connection with pre-assembled cable or terminal strip (Cage Clamp®) – Control block via CPX – AS-Interface – Individual connection – IO-Link – I-Port – AP interface |
|--|--|--|--|

Equipment options

Valve functions

- | | | | |
|--|--|---|---|
| <ul style="list-style-type: none"> • 2x 2/2-way valve, single solenoid, pneumatic spring, normally closed • 2x 3/2-way valve, single solenoid <ul style="list-style-type: none"> – Normally open – Normally open, reversible – Normally closed – Normally closed, reversible • 2x 3/2-way valve, single solenoid <ul style="list-style-type: none"> – 1x normally open, 1x normally closed – 1x normally open, 1x normally closed, reversible | <ul style="list-style-type: none"> • 5/2-way solenoid valve <ul style="list-style-type: none"> – Single solenoid, pneumatic spring/mechanical spring – Double solenoid – Double solenoid with dominant signal • 5/2-way valves for special functions, single solenoid <ul style="list-style-type: none"> – Mechanical spring – Switching position sensing via inductive sensors with PNP or NPN output – Protection against unexpected start-up to EN 1037 – Reversing • 5/3-way solenoid valve <ul style="list-style-type: none"> – Mid-position pressurised – Mid-position closed – Mid-position exhausted | <ul style="list-style-type: none"> • 5/3-way solenoid valve for special functions <ul style="list-style-type: none"> – Switching position 14 is retained (switching position 14 is retained in the event of an emergency off application/power failure), there is no spring return to switching position 12. – Only for valve terminal (plug-in) – Mid-position exhausted or mid-position 1→2, 4→5 – Switching position 14 is retained – Pneumatic spring return | <ul style="list-style-type: none"> • 5/3-way solenoid valve for special functions <ul style="list-style-type: none"> – Switching position 12 is retained (switching position 12 is retained in the event of an emergency off application/power failure), there is no spring return to switching position 14. – Only for valve terminal (plug-in) – Mid-position exhausted or mid-position 1→4, 2→3 – Switching position 12 is retained – Pneumatic spring return • Soft-start valve for slow and safe pressure build-up <ul style="list-style-type: none"> – High degree of safety – Sensing function provides feedback on switching operation |
|--|--|---|---|

Key features

Connection variants

Individual valve on individual sub-base, plug-in

- Electrical connection via standardised 4-pin M12 plug or via 4-pin spring-loaded terminal for configuration by the user

- Available with internal/external pilot air supply

Individual valve on individual sub-base, square plug or plug-in

- With integrated switching position sensing
- Electrical connection to EN 175301-803 type C (square plug) or

- For configuration by the user via 4-pin spring-loaded terminal or
- Cable with open end

Fieldbus interface CPX terminal

- Max. 32 valve positions/max. 32 solenoid coils
- Any compressed air supply
- Any number of pressure zones

Fieldbus interface CPX terminal with VTSA-F-CB

- Serial communication in the pneumatic part
- Up to 6 voltage zones for load voltage of the valves in the pneumatic part
- Flexible shutdown of up to 3 voltage zones in the CPX interfaces, either internally with PROFIsafe or externally by 3x M12

- Pilot air switching valve with integrated pressure sensor and connection via internal bus
- Soft-start valve with integrated pressure sensor and connection via internal bus

- Vacuum generator with 3 performance settings, air-saving circuit, optional increased ejection rate (power ejector pulse) and connection via internal bus, parameters can be configured via the CPX system

Valve terminal with individual connection

- Max. 20 valve positions/ max. 20 solenoid coils
- Any compressed air supply
- Any number of pressure zones

Valve terminal with multi-pin plug connection

- Max. 32 valve positions/ max. 32 solenoid coils
- Parallel, modular valve linking
- Any compressed air supply
- Any number of pressure zones

AS-Interface

- 1 to 8 valve positions/max. 8 solenoid coils
- Soft-start valve for slow and safe pressure build-up

I-Port

- Max. 16 valve positions/ max. 32 solenoid coils
- Connection to an I-Port master
- Direct mounting of a bus node

IO-Link

- Max. 16 valve positions/ max. 32 solenoid coils
- Connection to an IO-Link master

AP interface

- Max. 12 valve positions/ max. 24 solenoid coils
- Connection to an AP bus master

Combinable

- Valve width 18 mm: flow rate of VTSA up to 550 l/min, VTSA-F up to 700 l/min
- Width 26 mm: flow rate of VTSA up to 1100 l/min, VTSA-F up to 1350 l/min

- Valve width 42 mm: flow rate of VTSA up to 1300 l/min, VTSA-F up to 1860 l/min
- Width 52 mm: valve flow rate up to 2900 l/min

- Widths 18 mm, 26 mm, 42 mm, 52 mm and 65 mm can be combined on a single valve terminal (using an adapter – not for VTSA-F-CB)

- Valve terminal VTSA complies with
- ISO 15407-2 for width 18 and 26 mm
- ISO 5599-2 for width 42 and 52 mm

Key features

Valve terminal configurator			
General	VTSA	VTSA-F	VTSA-F-CB
<p>A valve terminal configurator is available to help you select a suitable VTSA valve terminal, making it much easier to order the right product.</p> <p>The valve terminals are assembled according to your order specification and are individually checked. This reduces assembly and installation time to a minimum.</p>	<ul style="list-style-type: none"> Valve terminal to ISO 15407-2 and ISO 5599-2 (flow rate: standard). Parallel communication between CPX module and switching valves VTSA 	<ul style="list-style-type: none"> Valve terminal, flow rate-optimised (interlinking blocks) (flow rate: increased). Parallel communication between CPX module and switching valves VTSA 	<p style="text-align: right;">→ Internet: www.festo.com</p> <ul style="list-style-type: none"> Valve terminal: optimised in terms of flow rate and communication (flow rate: increased). Serial communication between the CPX module and selected VTSA modules
	Order a valve terminal VTSA using the order code:	Order a valve terminal VTSA-F using the order code:	Order a valve terminal VTSA-F-CB using the order code:
	Ordering system for VTSA → Internet: vtsa	Ordering system for VTSA-F → Internet: vtsa-f	Ordering system for VTSA-F-CB → Internet: vtsa-f-cb
	Ordering system for CPX → Internet: cpx	Ordering system for CPX → Internet: cpx	Ordering system for CPX → Internet: cpx

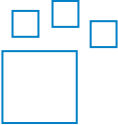
Ordering data – Product options																					
	<p>Configurable product</p> <p>This product and all its product options can be ordered using the configurator.</p>	<p>The configurator can be found at</p> <p>→ www.festo.com/catalogue/...</p> <p>Enter the part number or the type.</p>	<table border="1"> <thead> <tr> <th>Part no.</th> <th>Type</th> </tr> </thead> <tbody> <tr> <td>539215</td> <td>VTSA-MP</td> </tr> <tr> <td>547963</td> <td>VTSA-F-MP</td> </tr> <tr> <td>539217</td> <td>VTSA-FB</td> </tr> <tr> <td>547965</td> <td>VTSA-F-FB</td> </tr> <tr> <td>8130719</td> <td>VTSA-F-FB-AP</td> </tr> <tr> <td>555564</td> <td>VTSA-ASI</td> </tr> <tr> <td>555566</td> <td>VTSA-F-ASI</td> </tr> <tr> <td>8073100</td> <td>VTSA-F-CB</td> </tr> </tbody> </table>	Part no.	Type	539215	VTSA-MP	547963	VTSA-F-MP	539217	VTSA-FB	547965	VTSA-F-FB	8130719	VTSA-F-FB-AP	555564	VTSA-ASI	555566	VTSA-F-ASI	8073100	VTSA-F-CB
Part no.	Type																				
539215	VTSA-MP																				
547963	VTSA-F-MP																				
539217	VTSA-FB																				
547965	VTSA-F-FB																				
8130719	VTSA-F-FB-AP																				
555564	VTSA-ASI																				
555566	VTSA-F-ASI																				
8073100	VTSA-F-CB																				

Key features

Individual pneumatic connection

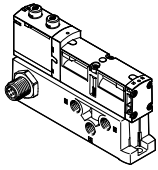

Valves on individual sub-bases up to width 52 mm can be used with actuators that are further away from the valve terminal.

The electrical connection is established either via a standardised 4-pin M12 plug 24 V DC (EN 61076-2-101), 4-pin spring-loaded terminal or a cable with open end 24 V DC, which are configured by the user.

Valve terminal with individual electrical connection

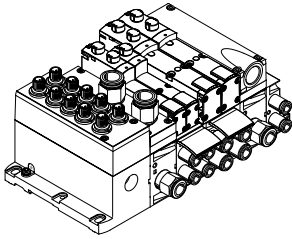

Control signals from the controller to the valve terminal are transmitted via an individual connecting cable.

The valve terminal can be equipped with max. 20 valves and max. 20 solenoid coils.

The electrical connection is established via a 5-pin M12 plug, 24 V DC.

Valve terminal with multi-pin plug connection

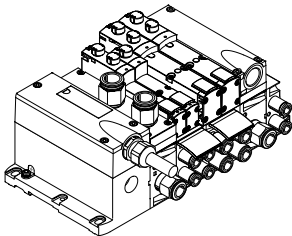

Control signals from the controller to the valve terminal are transmitted via a pre-assembled multi-wire cable or a self-assembled multi-pin plug connection (spring-loaded terminal). This substantially reduces installation time.

The valve terminal can be equipped with max. 32 valves and max. 32 solenoid coils.

Variants

- Multi-pin plug connection with terminal strip (spring-loaded terminal), 24 V DC
- Pre-assembled connecting cable, 24 V DC
- Sub-D plug connector for assembly by the user, 37-pin, 24 V DC
- Round plug M23, 19-pin, 24 V DC

AS-Interface connection

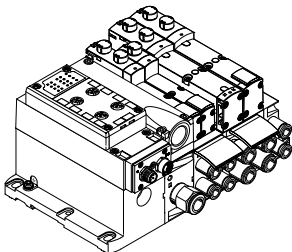

A special feature of the AS-Interface is the simultaneous transmission of data and supply power via a two-wire cable. The encoded cable profile prevents connection with incorrect polarity. The valve terminal with AS-Interface is available in the following versions:

- With one to eight modular valve positions (max. 8 solenoid coils). This corresponds to one to eight valves VSVA.
- With all available valve functions

The connection technology used for the inputs can be selected as with CPX: M8, M12, Sub-D, spring-loaded terminal (terminals to IP20).

Further information

→ Internet: as-interface

Note

The valve terminal VTSA/VTSA-F with AS-Interface connection is based on the same electrical links as the valve terminal with multi-pin plug connection. This means a valve terminal with multi-pin plug connection can be converted using an AS-Interface module (→ page 156). The technical specifications of the AS-Interface system must be observed in this case.

→ Page 73

→ Internet: as-interface

Key features

Valve terminal with I-Port/IO-Link connection

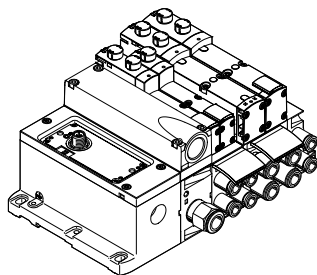

The connection to a higher-order controller can be achieved by:

- Connection to an I-Port master from Festo (e.g. CPX-CTEL)
- Direct mounting of a bus node on the I-Port interface
- Connection to an IO-Link master (in IO-Link mode)

The valve terminal can comprise a maximum of 32 solenoid coils or 16 valve positions.

Valve terminal with AP interface

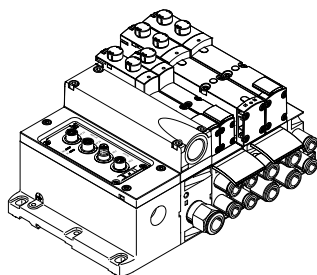

Control signals from the controller to the valve terminal are transmitted via the AP bus protocol from Festo.

The valve terminal can comprise a maximum of 24 solenoid coils or 12 valve positions.

Key features

Valve terminal with fieldbus interface from the CPX system

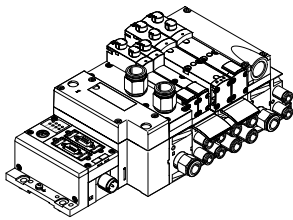

An integrated fieldbus node manages the communication connection with a higher-order PLC. This enables a space-saving pneumatic and electronic solution.

Valve terminals with fieldbus interfaces from the CPX system can be configured with up to 16 manifold sub-bases. With 2 solenoid coils per connection, up to 32 solenoid coils can thus be actuated.

There is an extended range of functions in combination with the CPX system and the smart valve terminal VTSA-F-CB:

- Serial communication in the pneumatic part
- Several voltage zones for load voltage of the valves in the pneumatic part
- Flexible shutdown of up to 3 voltage zones in the CPX interface, either internally with PROFIsafe or externally by 3x M12
- Flexible zoning for electrical and pneumatic sections, for decentralised control of various system/machine areas

VTSA/VTSA-F versions

- PROFIBUS
- DeviceNet
- CANopen
- CC-Link
- EtherNet/IP
- EtherCAT
- Modbus TCP
- PROFINET
- POWERLINK
- Sercos III

VTSA-F-CB versions

- PROFIBUS
- EtherNet/IP
- EtherCAT
- PROFINET

→ Internet: cpx

Valve terminal with control block connection from the CPX system

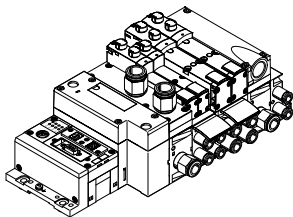

A controller integrated in the Festo valve terminal enables the construction of stand-alone control units with protection to IP65 without a control cabinet thanks to two different operating modes.

In the slave operating mode, these valve terminals can be used for intelligent preprocessing and are therefore ideal modules for designs using decentralised intelligence.

In the master operating mode, terminal groups can be designed with many options and functions that can autonomously control a medium-sized machine/system.

→ Internet: cpx

CP string extension from the CPX system

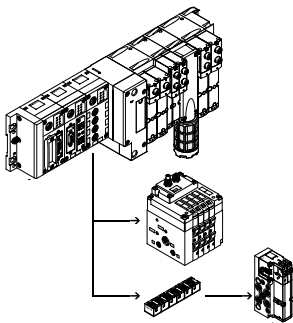

The optional CP string extension enables additional valve terminals and I/O modules to be connected to the fieldbus node of the CPX terminal on up to 4 CP strings. Different input and output modules as well as valve terminals MPA-S and CPV can be connected.

The maximum length of the CP string extension is 10 metres, which means that the extension modules can be mounted directly on-site. All the required electrical signals are transmitted via the CP cable, which in turn means that no further installation is needed on the extension module.

One CP string offers:

- 32 input signals
- 32 output signals for output stages 24 V DC or solenoid coils
- Logic and sensor supply for the input modules
- Load voltage supply for the valve terminals
- Logic supply for the output module

→ Internet: cpi

Key features – Valves

Solenoid valve with switching position sensing for VTSA/VTSA-F/VTSA-F-CB, width 18 mm, 26 mm

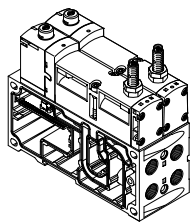

The 5/2-way single solenoid valve with spring return features switching position sensing.

The normal position of the piston spool is monitored.

It is available as a valve with plug-in or individual connection with pilot valves to ISO 15218 and square plug type C. This valve is not a safety device in accordance with the Machinery Directive 2006/42/EC.

It is suitable for use in safety-related parts of control systems to EN ISO 13849-1.

→ Page 161

Control block with safety function for VTSA/VTSA-F, width 26 mm

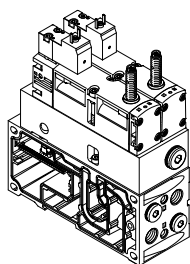

5/2-way solenoid valve

These valves are used for special applications, for example for:

- Protecting against unexpected start-up
- Safe reversing
- Drives in manually loaded machining jigs

This control block is suitable for use as a press safety valve to EN 962.

This valve is a safety device in accordance with the Machinery Directive 2006/42/EC.

→ Page 171

Pilot air switching valve for VTSA/VTSA-F, width 18 mm, 26 mm

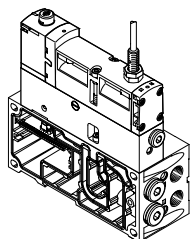

The pilot air switching valve is a combination of a 5/2-way solenoid valve with switching position sensing and the intermediate plate VABF-S4-...-S. It enables the pilot air supply to be verifiably switched on and off (sensing function) from duct 1 to 14 for the entire pressure zone or valve terminal.

Switching position sensing is carried out using an inductive PNP proximity switch with cable and 1xM12 push-in connector to EN 61076-2-104.

This valve is not a safety device in accordance with the Machinery Directive 2006/42/EC. It is suitable for use in safety-related parts of control systems to EN ISO 13849-1.

→ Page 178

 **Note**

The pilot air switching valve can only be operated on the valve terminal VTSA/VTSA-F in combination with a right end plate for external pilot air type VABE-S6-1RZ-.... Port 14 on the right end plate must then be sealed.

Key features – Valves

Pilot air switching valve for VTSA-F-CB with serial communication

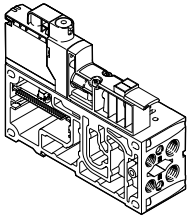

The pilot air switching valve is used for pressurising and exhausting duct 14 for one pressure zone, or the entire valve terminal VTSA-F-CB.

The pilot air switching valve enables additional functions in combination with the CPX system:

- Comprehensive diagnostics
- Transmission of analogue signals
- The elimination of cable connections between the pneumatic and electrical sections

In combination with the CPX system, an integrated pressure sensor and integrated feedback enable wireless detection of the status of the pilot air switching valve.

The pilot air switching valve can be used to realise the safety function "Protection against unexpected start-up".

The pilot air switching valve can be supplied with compressed air internally via the valve terminal or externally via duct 2.

The hybrid manifold sub-base can be equipped both with an 18 mm and a 26 mm solenoid valve.

This valve is not a safety device in accordance with the Machinery Directive 2006/42/EC.

It is suitable for use in safety-related parts of control systems to EN ISO 13849-1.

→ Page 187

Soft-start valve for VTSA/VTSA-F, module width 43 mm

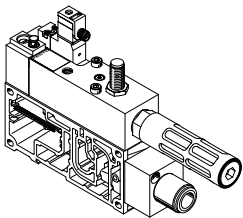

The soft-start valve is separately electrically actuated, independently of the multi-pin plug connection, AS-Interface or fieldbus interface, via a square plug of type C to EN 175301-803 or optionally via an M12 adapter.

The valve can optionally be ordered with a sensor that monitors switching of the soft-start valve. The soft-start valve can supply the valve terminal or one or more pressure zones with compressed air.

The pressure build-up for each pressure zone is optimised for the application directly at the valve terminal by setting the switch-over pressure and the filling time.

A maximum of 5 soft-start valves can thus be integrated on one valve terminal.

→ Page 194

Soft-start valve for VTSA-F-CB with serial communication

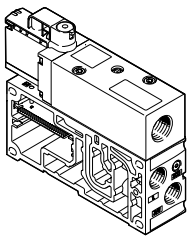

The soft-start valve pressurises/exhausts duct 1 (supply air) of the valve terminal, or one or more pressure zones.

The soft-start valve enables additional functions in combination with the CPX system:

- Comprehensive diagnostics
- Transmission of analogue signals
- The elimination of cable connections between the pneumatic and electrical sections of the CPX/VTSA-F-CB

In combination with the CPX system, an integrated pressure sensor and integrated feedback enable wireless detection of the status of the soft-start valve.

The filling time can be adjusted; the switch-over pressure is set to half the operating pressure. The pressure build-up for each pressure zone can thus be optimised for the application directly at the valve terminal.

This valve is not a safety device in accordance with the Machinery Directive 2006/42/EC.

It is suitable for use in safety-related parts of control systems to EN ISO 13849-1.

→ Page 204

Key features – Valves

Vacuum block for VTSA-VTSA-F, module width 53 mm

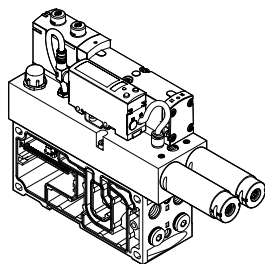

5/3-way solenoid valve, with switching position 12 retained.

The vacuum block is screwed to a manifold sub-base for 2 valve positions, width 26 mm, and thus integrated into the valve terminal VTSA/VTSA-F.

The vacuum block is supplied with power and the vacuum is sensed via a standardised 4-pin M12 plug.

The vacuum block is used in conjunction with a suction gripper to pick up, hold and place components. An adjustable ejector pulse is used for setting the components down.

The vacuum block is equipped with an air saving function.

If the electrical or pneumatic supply fails, the valve moves to switching position 12 "generate vacuum".

→ Page 215

5/3-way solenoid valve for special functions

For holding, blocking a movement (mechanically)

5/3-way solenoid valve for special functions; port 2 is pressurised, port 4 exhausted. Switching position 14 is retained (code SA) or switching position 12 is retained (code SE).

Possible applications:

- Using lifting cylinders
- Using rotary cylinders

For pressureless switching, self-holding, pneumatic operation

5/3-way solenoid valve for special functions (3 phases). Mid-position is exhausted. Switching position 14 is retained (code SA) or switching position 12 is retained (code SE).

Possible applications:

- Pneumatic manual clamps for devices (inserting stations)

Integrated vacuum generator for VTSA-F-CB with serial communication

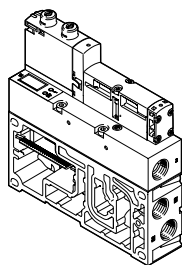

The vacuum generator in combination with the CPX/VTSA-F-CB and FMT (Festo Maintenance Tool) offers additional smart functions:

- Opening and saving of up to four records (on a local computer)
- Teach-in functionality: recording homing runs, gripping and holding the workpiece, and setting it down

- Preventive maintenance: measurement of all vacuum times, comparison with the homing run, warning message if a definable level of deviation is reached

- Locking the ejector pulse: either when a safety function (voltage zone with safe shut-off within the valve terminal) is requested or when there is a fault with the valve load voltage (e.g. undervoltage)

- Switching air-saving function on/off
- Changing the vacuum limits per data record

The vacuum generator is used in conjunction with a suction gripper to pick up, hold and place components. An adjustable ejector pulse is used for setting the components down.

→ Page 220

Peripherals

Modular pneumatic peripherals

The modular design of the valve terminal VTSA/VTSA-F/VTSA-F-CB enables great flexibility right from the planning stage and offers maximum ease of service in operation.

The system consists of manifold sub-bases and valves.

The manifold sub-bases are screwed together and thus form the support system for the valves.

Inside the manifold sub-bases are the connection ducts for supplying compressed air to and exhausting the valve terminal as well as the working ports for the pneumatic cylinders for each valve.

Each manifold sub-base is connected to the next using four screws. Individual valve terminal sections can be isolated and further blocks easily inserted by loosening these screws. This ensures that the valve terminal can be rapidly and reliably extended.

Basic system modularity

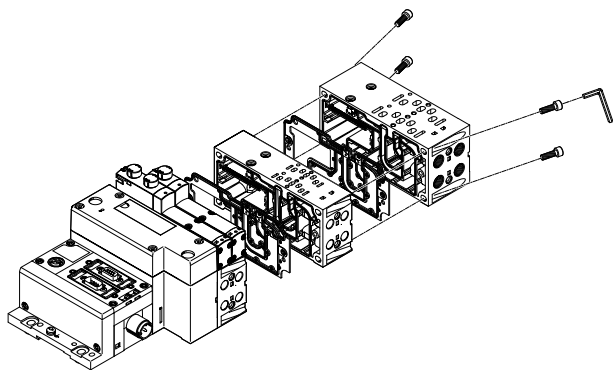

Valve modularity

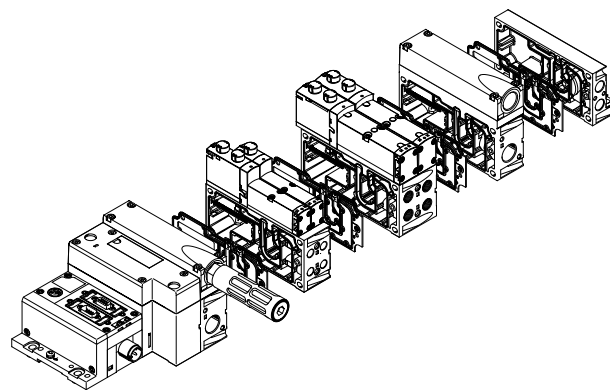

Vertical stacking modularity

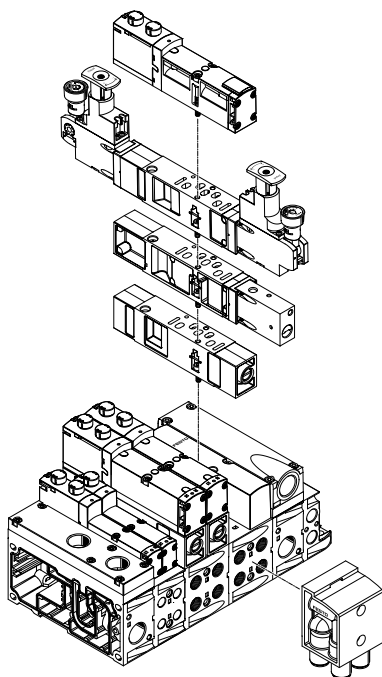

Peripherals

Modular electrical peripherals

How the valves are actuated depends on whether a multi-pin terminal or fieldbus terminal is used.

The VTSA/VTSA-F with CPX interface is based on the internal bus system of the CPX and uses this communication system for all solenoid coils and a range of electrical input and output functions.

Parallel linking enables the following:

- Transmission of switching information
- Compact design
- Position-based diagnostics
- Separate power supply for valves
- Flexible conversion without address shifting
- Option of CP interface
- CPX-CEC as stand-alone controller with access via Ethernet and web server
- Transmission of status, parameter and diagnostic data
- → Internet: cpx

VTSA/VTSA-F with electrical peripherals CPX

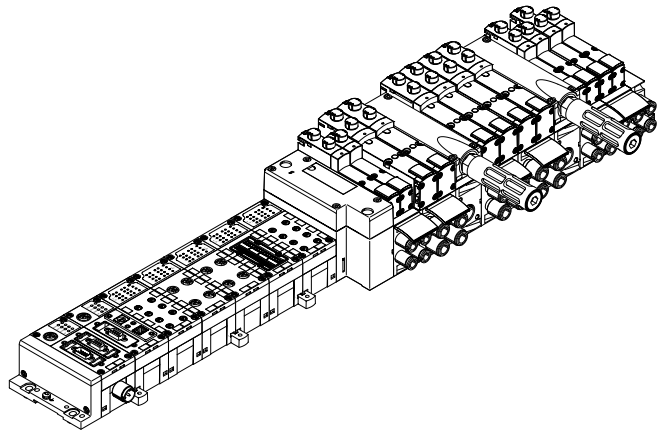

Modularity with electrical peripherals CPX

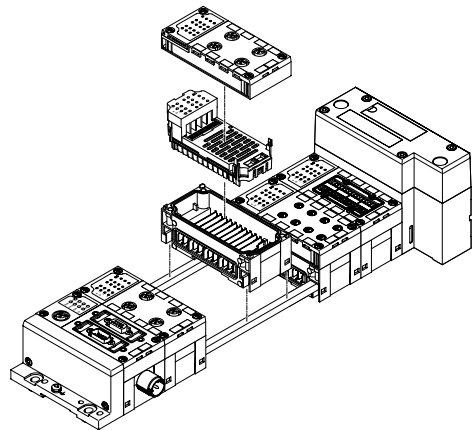

CPX terminal in metal design

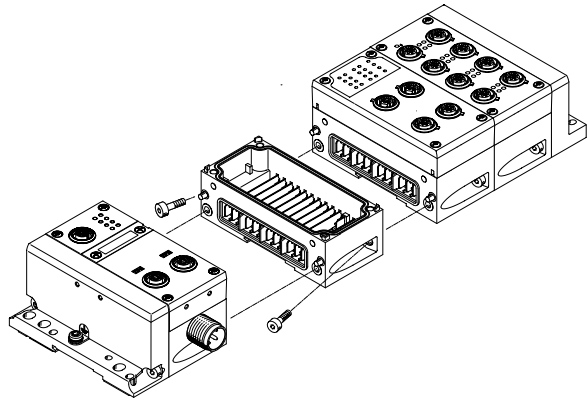

The mechanical connection between the metal CPX modules is created using special angled fittings. The CPX terminal can thus be expanded at any time.

Note
The CPX manifold blocks are also available in metal. This means a complete solution in a sturdy metal design can be selected for applications of the valve terminal VTSA/VTSA-F/VTSA-F-CB in welding environments.

Peripherals – Pneumatic components

Valve terminal widths

Regardless of the type of control (e.g. multi-pin plug, fieldbus, etc.), valve terminals VTSA/VTSA-F of widths:

- 18 mm
- 26 mm
- 42 mm
- 52 mm

can be combined without adapters.

These four widths can also be used without an adapter for the valve terminal VTSA-F-CB controlled via CPX.

This enables a flow range for the VTSA of:

400 l/min to 2900 l/min

for the VTSA-F of:

700 l/min to 2900 l/min

and for the VTSA-F-CB of:

700 l/min to 2900 l/min

to be covered on one valve terminal.

A wide range of valve functions and vertical stacking components are available for all widths.

The valve terminal VTSA-F-CB is controlled via the CPX pneumatic interface with serial communication.

The valve terminal VTSA-F-CB cannot be installed in combination with a valve terminal VTSA/VTSA-F.

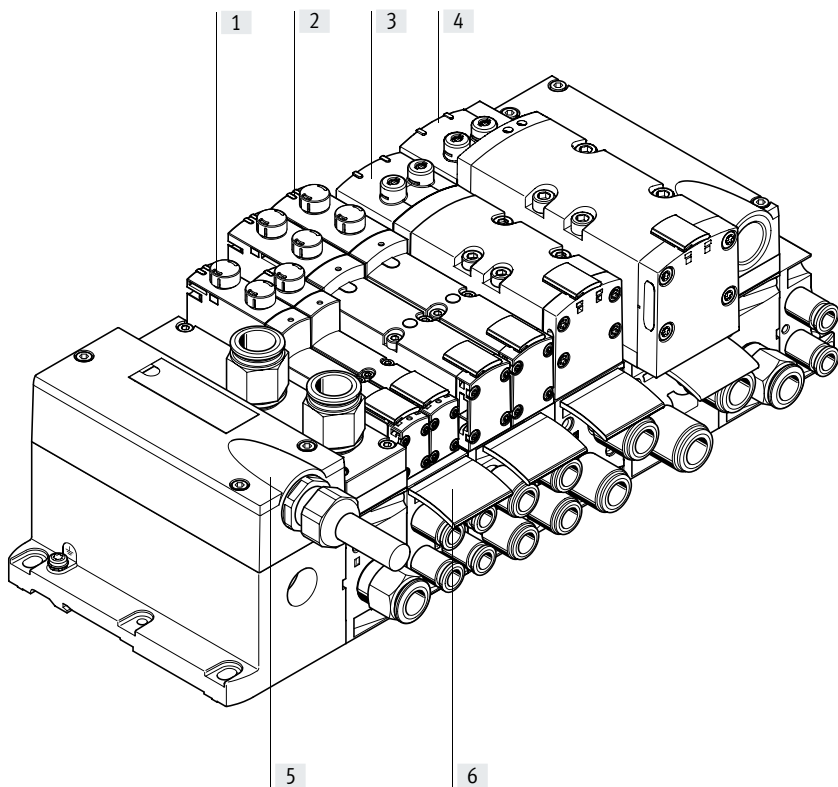

		Description	→ Page/Internet
[1]	Valve	Width 18 mm	112
[2]	Valve	Width 26 mm	121
[3]	Valve	Width 42 mm	130
[4]	Valve	Width 52 mm	138
[5]	Multi-pin plug connection	With 24 V DC multi-pin cable (VTSA/VTSA-F only)	155
[6]	Inscription label	For manifold sub-base, sub-base, 90°-connection plate	160

Peripherals – Pneumatic components

Individual sub-base, width 18 mm, ISO 15407-2

Order code: Individual sub-bases can be equipped with any valve.

- Using individual part numbers

The electrical connection is established via a standardised 4-pin M12 plug (EN 61076-2-101) or it can be configured by the user via a 4-pin clamped terminal connection/open cable end.

Width 18 mm with spring-loaded terminal or cable (open end)

Width 18 mm with M12 plug

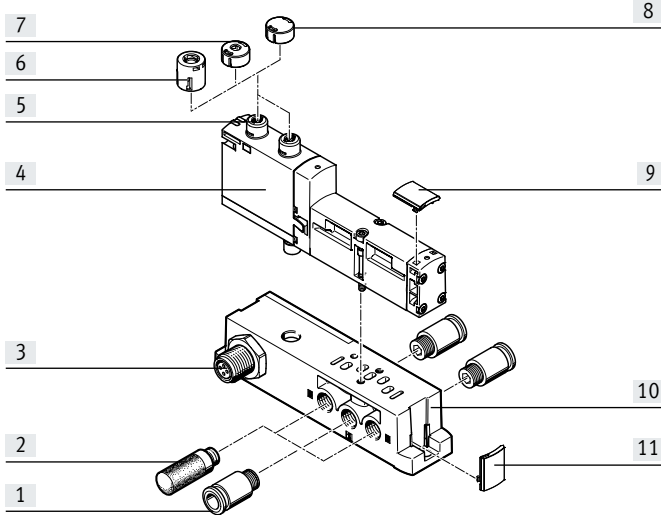
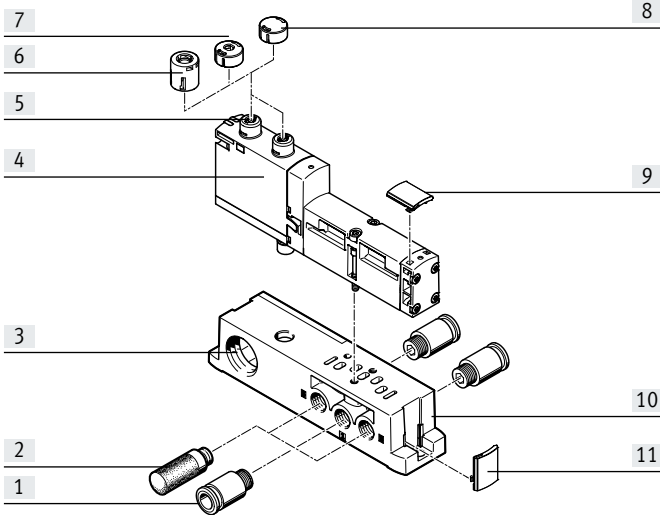

	Description		→ Page/Internet
[1]	Fitting	G1/8 for supply/exhaust air ports (1, 3, 5) and working ports (2, 4)	246
[2]	Silencers	U-1/8-B for exhaust ports (3, 5)	247
[3]	Electrical connection	Spring-loaded terminal, cable (open end) or M12 plug ¹⁾ , 4-pin	-
[4]	Valve VSVA	Width 18 mm	112
[5]	Manual override	Non-detenting/detenting, per solenoid coil	-
[6]	Cover cap, heavy duty	For manual override, non-detenting heavy duty, detenting via accessory	159
[7]	Cover cap, coded	For non-detenting manual override (limited function)	159
[8]	Cover cap, concealed	MO concealed by cover cap – operation of MO prevented	159
[9]	Inscription label holders	For valves	160
[10]	Individual sub-base	For valve VSVA	244
[11]	Inscription label holders	For manifold block	160

1) Only for 24 V DC

Peripherals – Pneumatic components

Individual sub-base, width 26 mm, ISO 15407-2

With spring-loaded terminal or cable (open end)

With M12 push-in connector

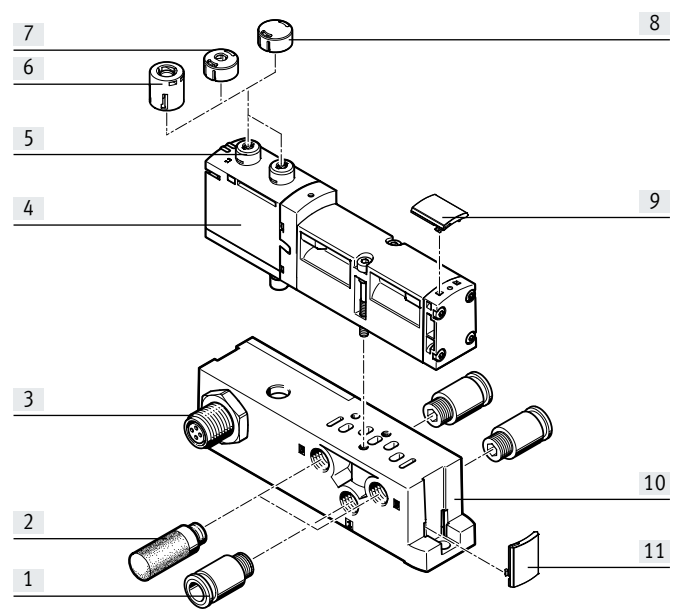
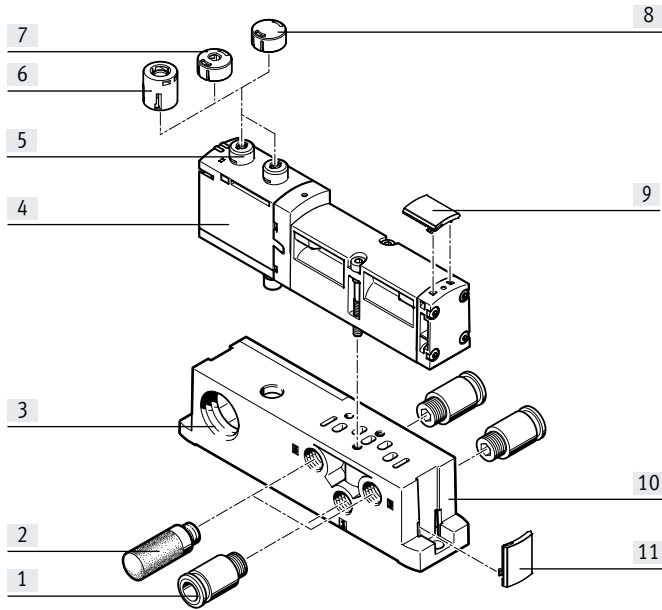

	Description	→ Page/Internet	
[1]	Fitting	G1/4 for supply/exhaust air ports (1, 3, 5) and working ports (2, 4)	246
[2]	Silencers	U-1/4-B for exhaust ports (3, 5)	247
[3]	Electrical connection	Spring-loaded terminal, cable (open end) or M12 plug ¹⁾ , 4-pin	-
[4]	Valve VSVA	Width 26 mm	121
[5]	Manual override	Non-detenting/detenting, per solenoid coil	-
[6]	Cover cap, heavy duty	For manual override, non-detenting heavy duty, detenting via accessory	159
[7]	Cover cap, coded	For non-detenting manual override (limited function)	159
[8]	Cover cap, concealed	MO concealed by cover cap – operation of MO prevented	159
[9]	Inscription label holders	For valves	160
[10]	Individual sub-base	For valve VSVA	244
[11]	Inscription label holders	For manifold block	160

1) Only for 24 VDC

Peripherals – Pneumatic components

Individual sub-base, width 42 mm, ISO 5599-2
 With spring-loaded terminal or cable (open end)

With M12 plug

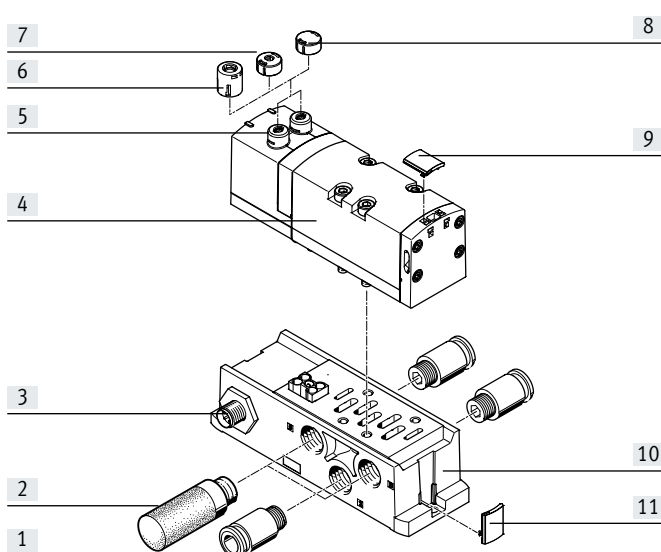
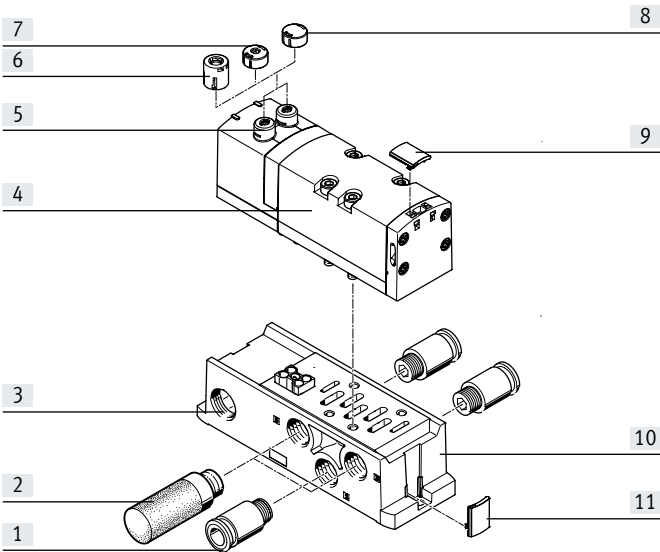

		Description	→ Page/Internet
[1]	Fitting	G3/8 for supply/exhaust air ports (1, 3, 5) and working ports (2, 4)	246
[2]	Silencers	U-3/8-B for exhaust ports (3, 5)	247
[3]	Electrical connection	Spring-loaded terminal, cable (open end) or M12 plug ¹⁾ , 4-pin	–
[4]	Valve VSVA	Width 42 mm	130
[5]	Manual override	Non-detenting/detenting, per solenoid coil	–
[6]	Cover cap, heavy duty	For manual override, non-detenting heavy duty, detenting via accessory	159
[7]	Cover cap, coded	For non-detenting manual override (limited function)	159
[8]	Cover cap, concealed	MO concealed by cover cap – operation of MO prevented	159
[9]	Inscription label holders	For valves	160
[10]	Individual sub-base	For valve VSVA	244
[11]	Inscription label holders	For manifold block	160

1) Only for 24 V DC

Peripherals – Pneumatic components

Individual sub-base, width 52 mm, ISO 5599-2

With spring-loaded terminal or cable (open end)

With M12 plug

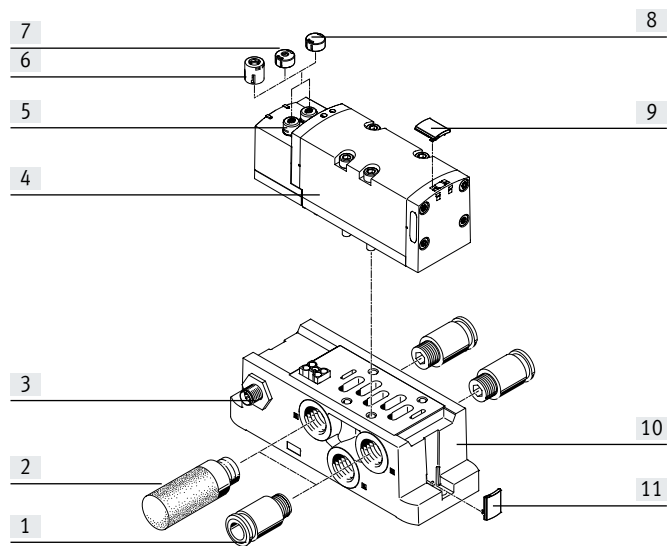
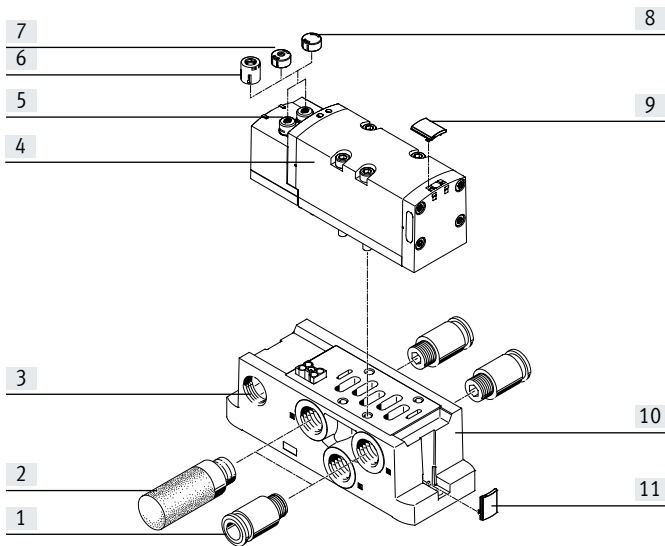

		Description	→ Page/Internet
[1]	Fitting	G1/2 for supply/exhaust air ports (1, 3, 5) and working ports (2, 4)	246
[2]	Silencers	U-1/2-B for exhaust ports (3, 5)	247
[3]	Electrical connection	Spring-loaded terminal, cable (open end) or M12 plug ¹⁾ , 4-pin	–
[4]	Valve VSVA	Width 52 mm	138
[5]	Manual override	Non-detenting/detenting, per solenoid coil	–
[6]	Cover cap, heavy duty	For manual override, non-detenting heavy duty, detenting via accessory	159
[7]	Cover cap, coded	For non-detenting manual override (limited function)	159
[8]	Cover cap, concealed	MO concealed by cover cap – operation of MO prevented	159
[9]	Inscription label holders	For valves	160
[10]	Individual sub-base	For valve VSVA	244
[11]	Inscription label holders	For manifold block	160

1) Only for 24 V DC

Peripherals – Pneumatic components

Pneumatic components of valve terminal VTSA/VTSA-F

The conventional manifold sub-bases for valves with a width of 18 or 26 mm are either suitable for

- 2 single solenoid valves or
- 2 double solenoid valves

The manifold sub-bases for valves with a width of 42 or 52 mm are suitable for:

- 1 single solenoid valve or
- 1 double solenoid valve

• Double solenoid valve positions can be equipped with any valve or a cover plate.

• Single solenoid valve positions can only be equipped with single solenoid valves or a cover plate.

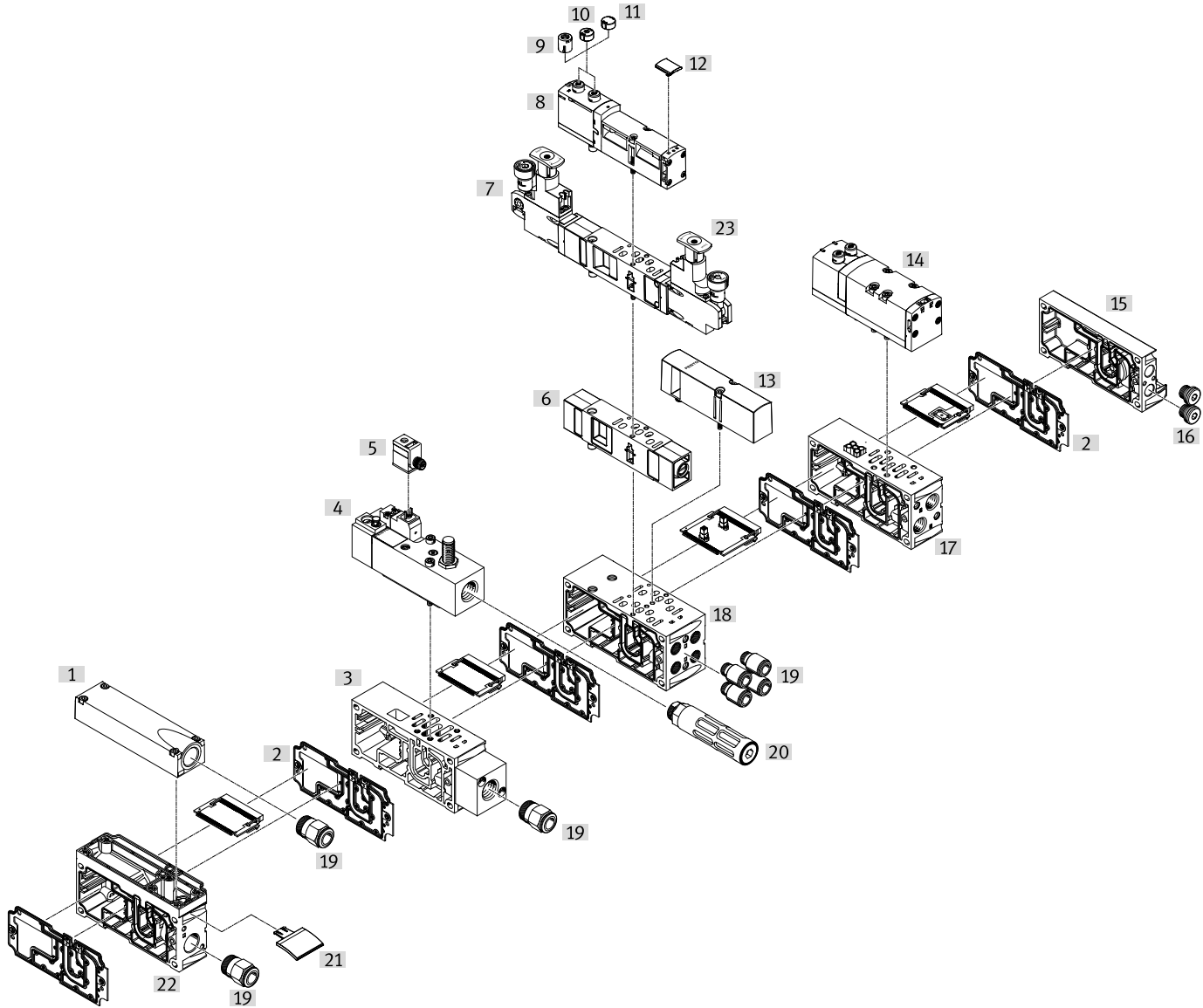

Peripherals – Pneumatic components

Pneumatic components of valve terminal VTSA/VTSA-F			→ Page/Internet
		Description	
[1]	Exhaust port cover	For ducted exhaust air (ports 3 and 5 combined)	147
[2]	Duct separation/seal	–	159
[3]	Manifold sub-base	For soft-start valve	202
[4]	Soft-start valve	For slow and safe pressure build-up	194
[5]	Plug socket	–	203
[6]	Throttle plate	–	153
[7]	Pressure regulator plate	–	148
[8]	Valve	Width 18 mm or 26 mm	112, 121
[9]	Cover cap, heavy duty	For manual override, non-detenting heavy duty, detenting via accessory	159
[10]	Cover cap, coded	For non-detenting manual override (limited function)	159
[11]	Cover cap, concealed	MO concealed by cover cap – operation of MO prevented	159
[12]	Inscription label holders	For valve	160
[13]	Cover plate	For unused valve position (vacant position)	153
[14]	Valve	Width 42 mm or 52 mm	130, 138
[15]	End plate with pilot air selector	–	158
[16]	Blanking plug	–	247
[17]	Manifold sub-base VTSA	For valves with a width of 42 mm or 52 mm	146
[17]	Manifold sub-base VTSA-F	For valves with a width of 42 mm or 52 mm	146
[18]	Manifold sub-base VTSA	For valves with a width of 18 mm or 26 mm	146
[18]	Manifold sub-base VTSA-F	For valves with a width of 18 mm or 26 mm	146
[19]	Fittings	–	246
[20]	Silencers	–	247
[21]	Inscription label holders	For manifold sub-base, sub-base, 90°-connection plate	160
[22]	Supply plate	–	147
[23]	Control element	Regulator knobs in different versions	40

 **Note**

Special applications for the valve terminal, such as:

- Solenoid valve with switching position sensing
- Control block with safety function
- Pilot air switching valve
- Soft-start valve
- Vacuum block

are listed after → Accessories – General

Peripherals – Pneumatic components

Pneumatic components of valve terminal VTSA-F-CB

The conventional manifold sub-bases for valves with a width of 18 or 26 mm are either suitable for

- 2 single solenoid valves or
- 2 double solenoid valves

The hybrid manifold sub-base (with CBUS loop-through) makes it possible to use

- 1 double solenoid valve (18 mm) and
- 1 double solenoid valve (26 mm) together on the same manifold sub-base.

The manifold sub-bases for valves with a width of 42 or 52 mm are suitable for:

- 1 single solenoid valve or
- 1 double solenoid valve

Double solenoid valve positions can be equipped with any valve or a cover plate.

Single solenoid valve positions can only be equipped with single solenoid valves or a cover plate.

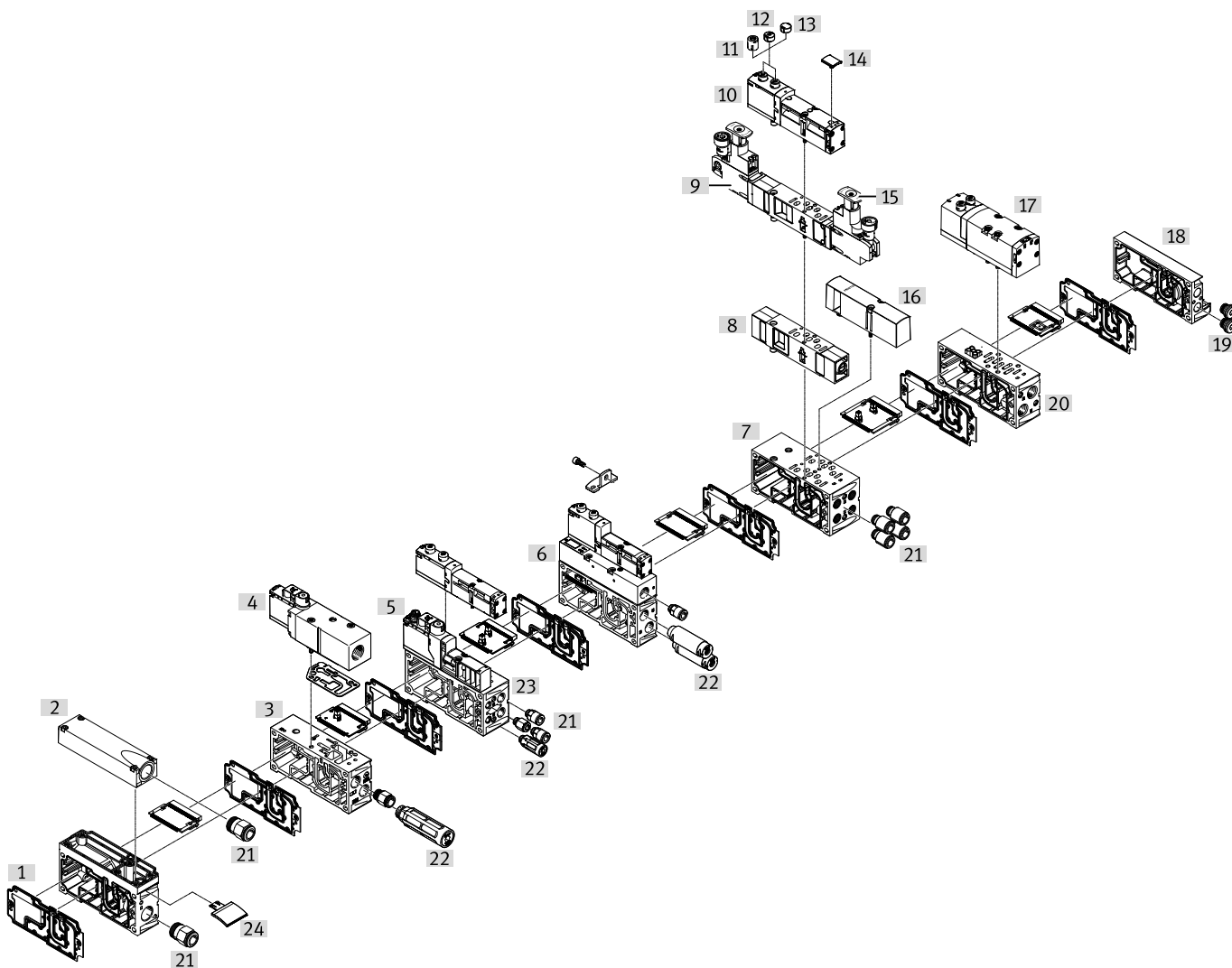

Peripherals – Pneumatic components

Pneumatic components of valve terminal VTSA-F-CB		Description	→ Page/Internet
[1]	Duct separation/seal	–	159
[2]	Exhaust port cover	For ducted exhaust air (ports 3 and 5 combined)	147
[3]	Manifold sub-base	For soft-start valve	209
[4]	Soft-start valve for VTSA-F-CB	For slow and safe pressure build-up	204
[5]	Pilot air switching valve for VTSA-F-CB	–	187
[6]	Vacuum generator for VTSA-F-CB	For vacuum generation	220
[7]	Manifold sub-base VTSA-F-CB	For valves with a width of 18 mm or 26 mm with CBUS loop-through	146
[8]	Throttle plate	–	153
[9]	Pressure regulator plate	–	148
[10]	Valve	Width 18 mm or 26 mm	112, 121
[11]	Cover cap, heavy duty	For manual override, non-detenting heavy duty, detenting via accessory	159
[12]	Cover cap, coded	For non-detenting manual override (limited function)	159
[13]	Cover cap, concealed	MO concealed by cover cap – operation of MO prevented	159
[14]	Inscription label holders	For valve	160
[15]	Control element	Regulator knobs in different versions	40
[16]	Cover plate	For unused valve position (vacant position)	153
[17]	Valve	Width 42 mm or 52 mm	130, 138
[18]	End plate with pilot air selector	–	158
[19]	Blanking plug	–	247
[20]	Manifold sub-base VTSA-F-CB	For valves with a width of 18 mm or 26 mm with CBUS loop-through	146
[21]	Fittings	–	246
[22]	Silencers	–	247
[23]	Manifold sub-base VTSA-F-CB	For pilot air switching valve (hybrid sub-base)	146
[24]	Inscription label holders	For manifold sub-base, sub-base, 90°-connection plate	160
[25]	Supply plate/air supply plate	–	147

 **Note**

Special applications for the valve terminal, such as:

- Solenoid valve with switching position sensing
- Control block with safety function
- Pilot air switching valve
- Soft-start valve
- Vacuum generators

are listed after → Accessories – General

Peripherals – Electric components

Valve terminal with individual electrical connection

Order code for VTSA:

- 44E... for the electric components
- 44P... for the pneumatic components

Order code for VTSA-F:

- 45E... for the electric components
- 45P... for the pneumatic components

Valve terminals VTSA/VTSA-F with individual electrical connection can be expanded with up to 20 valves with max. 20 solenoid coils.

The manifold sub-bases for valves with a width of 18 or 26 mm are suitable for either

- 2 single solenoid valves or
- 2 double solenoid valves

and the manifold sub-bases for valves with a width of 42, 52 and 65 mm are suitable for

- 1 single solenoid valve or
- 1 double solenoid valve

- Double solenoid valve positions can be equipped with any valve or a cover plate.
- Single solenoid valve positions can only be equipped with single solenoid valves or a cover plate.
- The electrical connection is established via a 5-pin M12 plug (24 V DC).

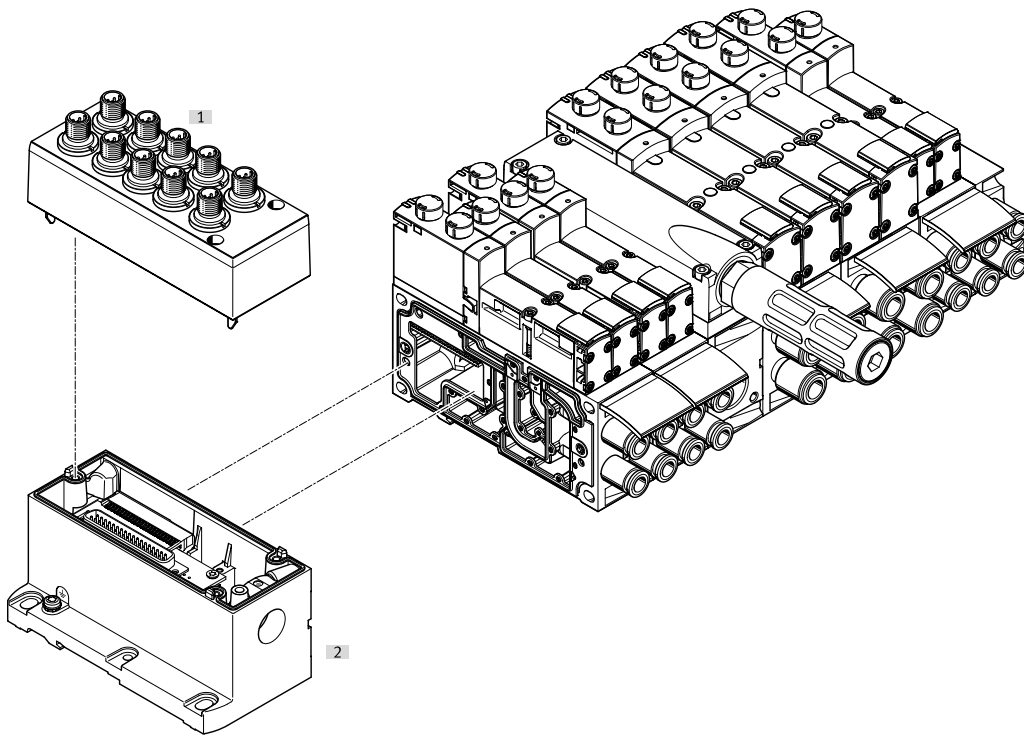

		Description	→ Page/Internet
[1]	Cover	For individual connection	155
[2]	Multi-pin plug connection	Individual connection with M12, 10-way or 6-way (including cover)	155

Peripherals – Electric components

Valve terminal with electrical multi-pin plug connection

Order code for VTSA:

- 44E... for the electric components
- 44P... for the pneumatic components

Order code for VTSA-F:

- 45E... for the electric components
- 45P... for the pneumatic components

Valve terminals VTSA/VTSA-F with multi-pin plug connection can be expanded with up to 32 valves with max. 32 solenoid coils. The manifold sub-bases for valves with a width of 18 or 26 mm are prepared for

- 2 single solenoid valves or
- 2 double solenoid valves

and the manifold sub-bases for valves with a width of 42, 52 and 65 mm are suitable for

- 1 single solenoid valve or
- 1 double solenoid valve

- Double solenoid valve positions can be equipped with any valve or a cover plate.
- Single solenoid valve positions can only be equipped with single solenoid valves or a cover plate.
- The following multi-pin plug connections to IP65 are available:
 - 37-pin Sub-D connection (24 V DC): the connecting cable can be ordered in lengths of 2.5 m, 5 m and 10 m for max. 8, 22 or 32 solenoid coils respectively.
- Terminal strip (24 V DC), 19-pin round plug (24 V DC)

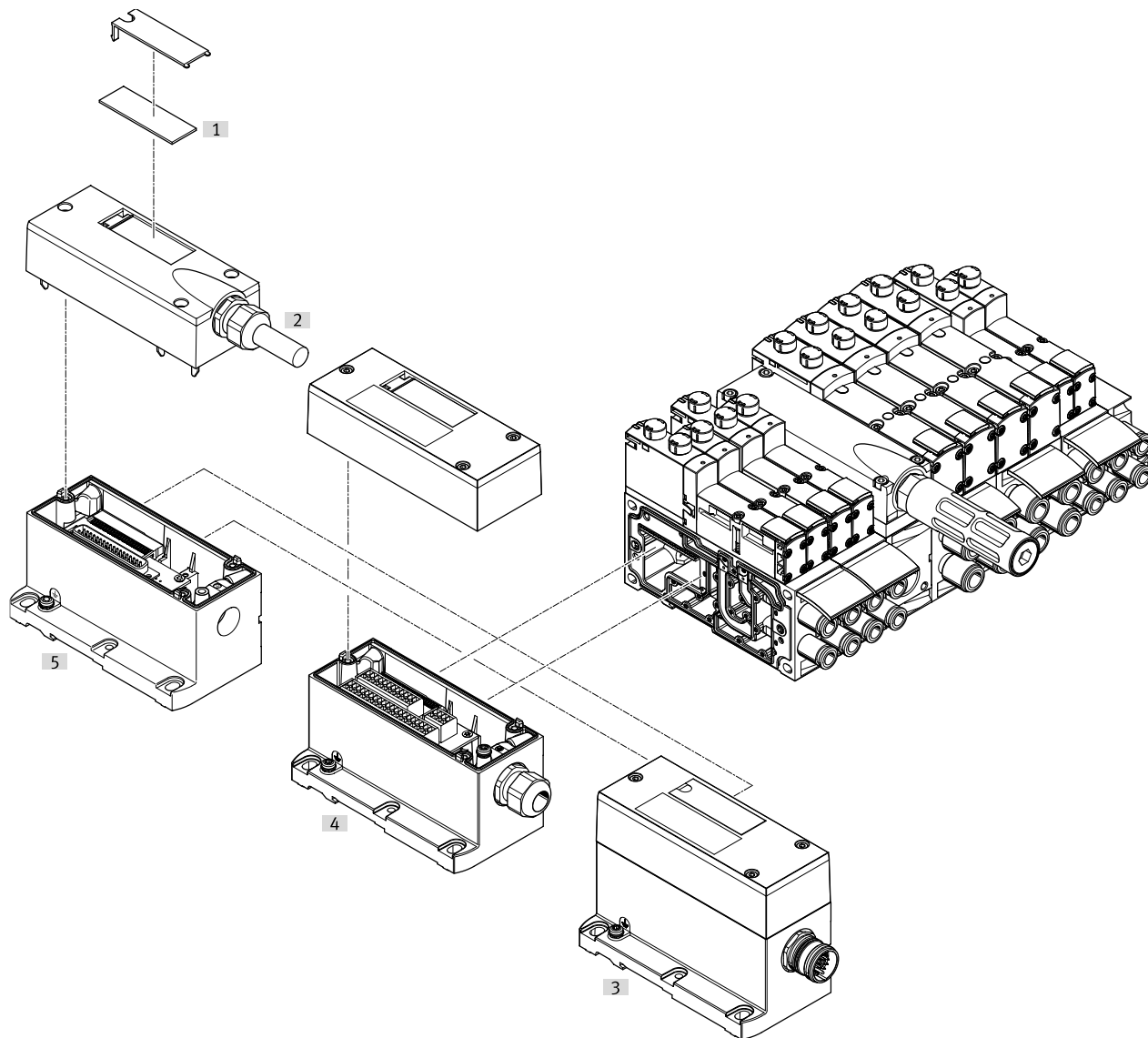

	Description	→ Page/Internet
[1]	Inscription label Large, for multi-pin plug connection	-
[2]	Multi-pin cable Connecting cable	158
[3]	Multi-pin plug connection Via M23 round plug connection, 24 V DC	155
[4]	Multi-pin plug connection Via terminal strip (CageClamp) 24 V DC	155
[5]	Multi-pin plug connection Via multi-pin cable, 24 V DC	155

Peripherals – Electric components

Valve terminal with AS-Interface connection

Order code for VTSA:

- 52E... for the electric components
- 44P... for the pneumatic components

Order code for VTSA-F:

- 52E... for the electric components
- 45P... for the pneumatic components

Valve terminals VTSA/VTSA-F with AS-Interface connection can be expanded with up to 8 valves with max. 8 solenoid coils.

The manifold sub-bases for valves with a width of 18 or 26 mm are suitable for either

- 2 single solenoid valves or
- 2 double solenoid valves

and the manifold sub-bases for valves with a width of 42, 52 and 65 mm are suitable for

- 1 single solenoid valve or
- 1 double solenoid valve

- Double solenoid valve positions can be equipped with any valve or a cover plate.

- Single solenoid valve positions can only be equipped with single solenoid valves or a cover plate.

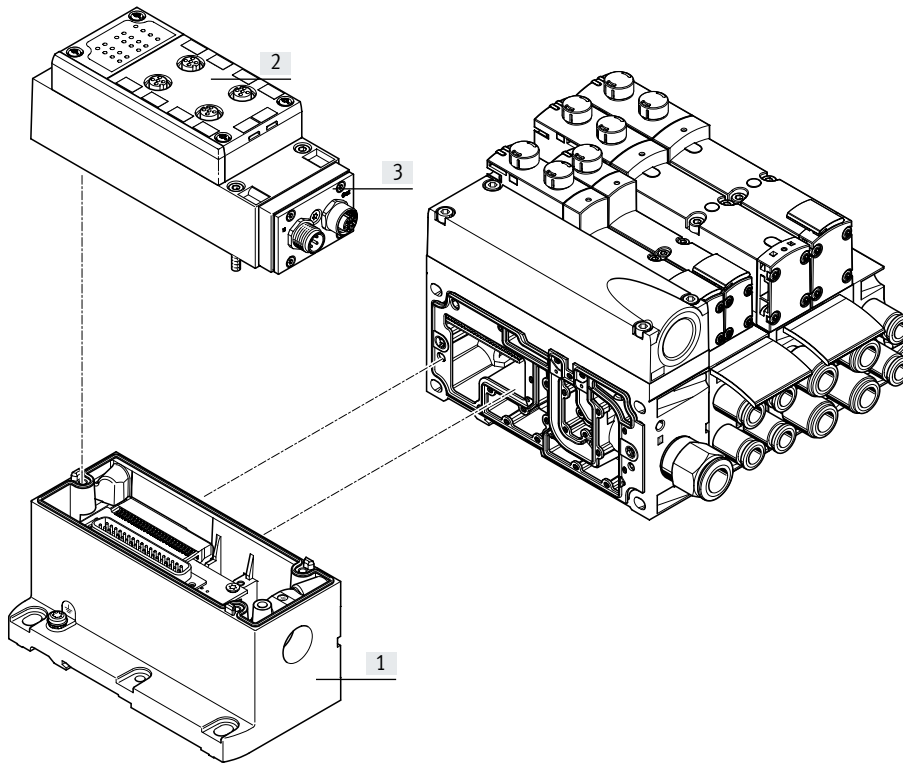

	Description	→ Page/Internet
[1]	Multi-pin plug connection	Can be ordered together with the AS-Interface module as an electrical connection for AS-Interface 156
[2]	Connection block for AS-Interface	- 156
[3]	AS-Interface module	- 156

Peripherals – Electrical components

Valve terminal with I-Port/IO-Link connection

Order code for VTSA:

- 44E... for the electrical components
- 44P... for the pneumatic components

Order code for VTSA-F:

- 45E... for the electrical components
- 45P... for the pneumatic components

Valve terminals VTSA/VTSA-F with I-Port/IO-Link connection can be expanded with up to 16 valves with max. 32 solenoid coils. The manifold sub-bases for valves with a width of 18 or 26 mm are suitable for either

- 2 single solenoid valves or
- 2 double solenoid valves

and the manifold sub-bases for valves with a width of 42 or 52mm are suitable for

- 1 single solenoid valve or
- 1 double solenoid valve

depending on the size.

- Double solenoid valve positions can be equipped with any valve or a cover plate.
- Single solenoid valve positions can only be equipped with single solenoid valves or a cover plate.

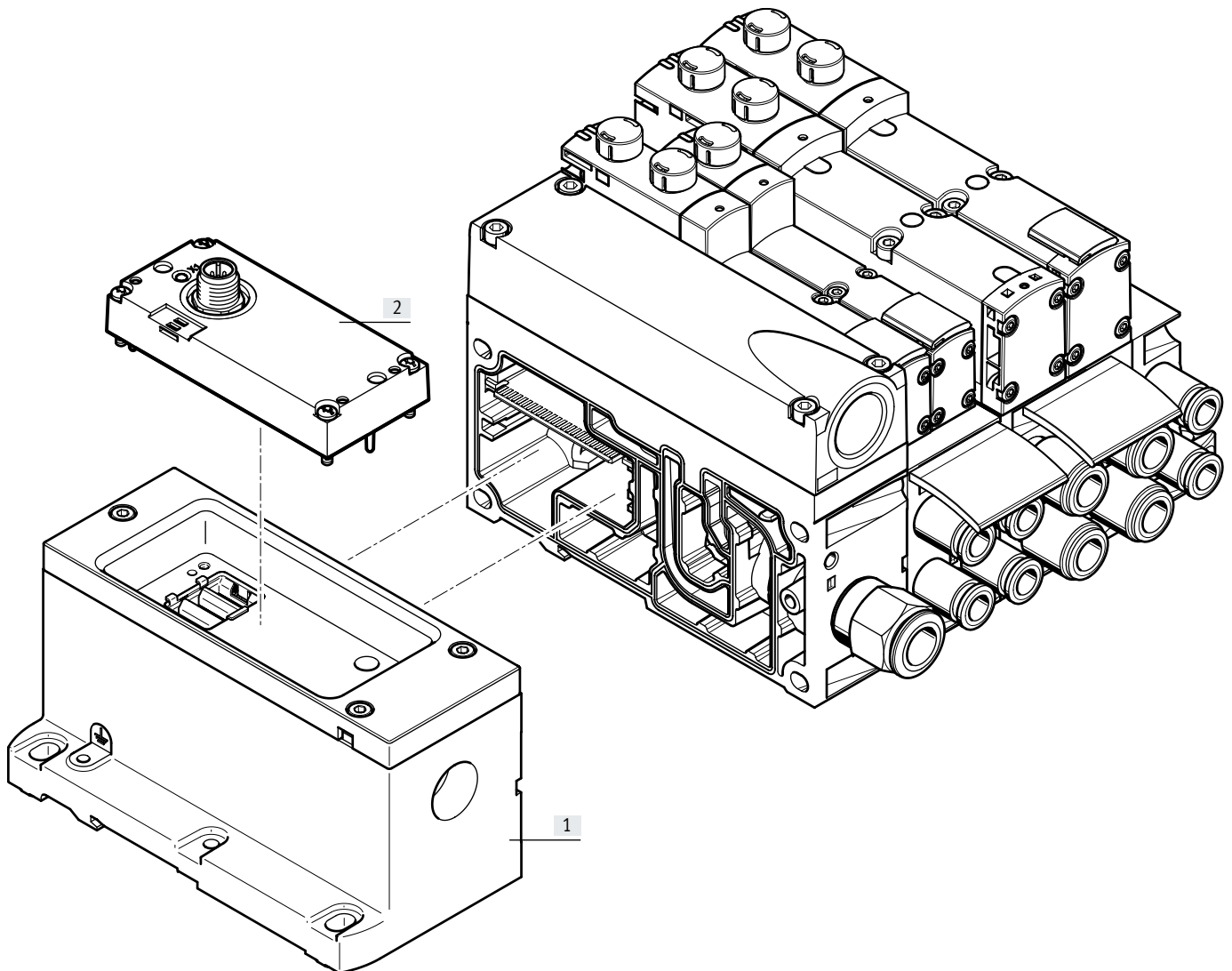

		Description	→ Page/Internet
[1]	Multi-pin plug connection	–	155
[2]	I-Port/IO-Link connection	Electrical interface IO-Link	156

Peripherals – Electrical components

Valve terminal with AP interface

Order code for VTSA:

- 44E... for the electric components
- 44P... for the pneumatic components

Order code for VTSA-F:

- 45E... for the electric components
- 45P... for the pneumatic components

VTSA/VTSA-F valve terminals with AP interface can be expanded with up to 12 valves with a maximum of 24 solenoid coils. The manifold sub-bases for valves with a width of 18 or 26 mm are suitable for either

- 2 single solenoid valves or
- 2 double solenoid valves

and the manifold sub-bases for valves with a width of 42 or 52 mm are suitable for

- 1 single solenoid valve or
- 1 double solenoid valve

- Double solenoid valve positions can be equipped with any valve or a cover plate.

- Single solenoid valve positions can only be equipped with single solenoid valves or a cover plate.

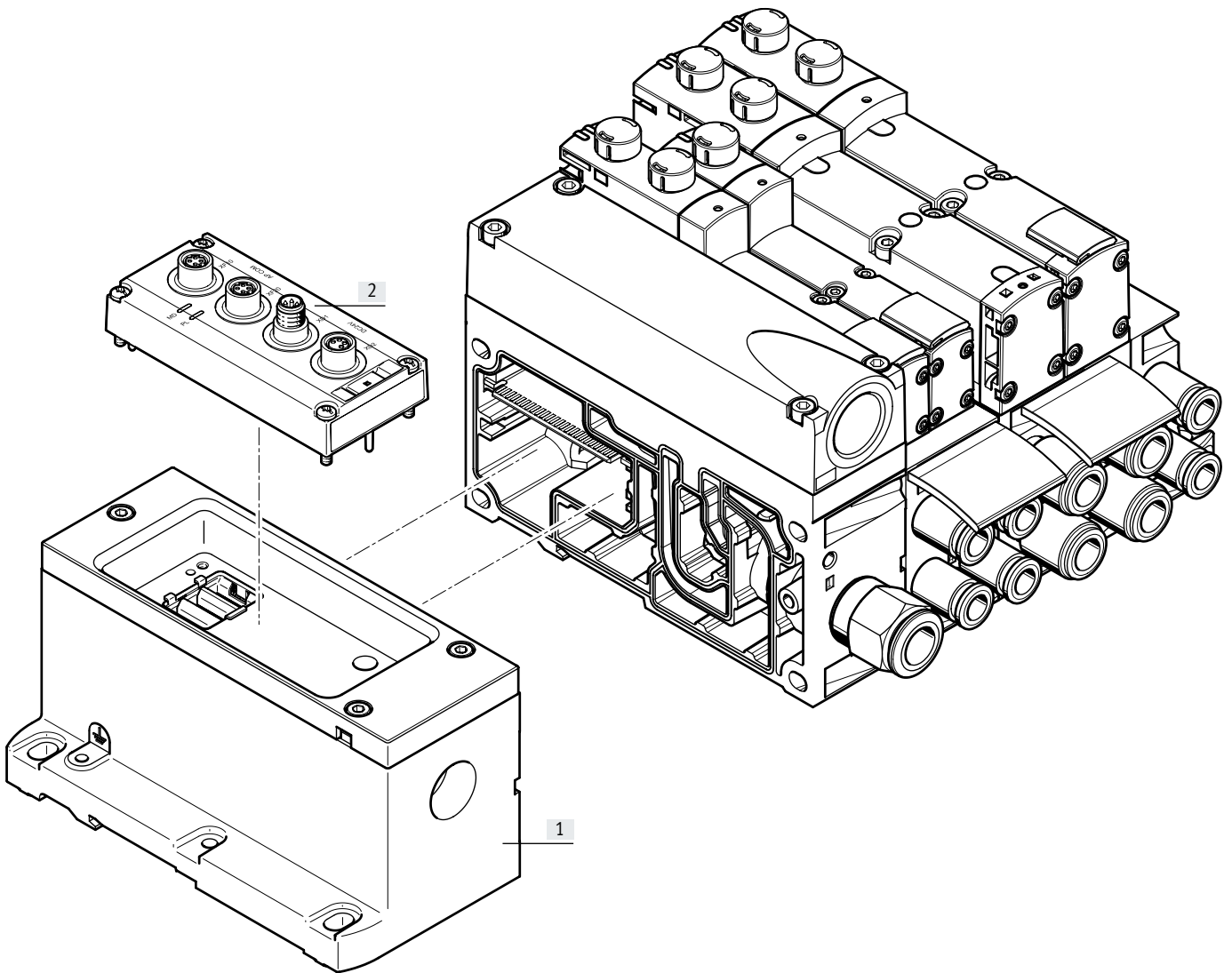

		Description	→ Page/Internet
[1]	Multi-pin plug connection	-	155
[2]	AP interface	Electrical interface protocol AP-COM	80

Peripherals – Electric components

Valve terminal with fieldbus interface, control block (electrical peripherals CPX)

Order code:

- 50E... for the electrical peripherals, polymer variant
- 51E... for the electrical peripherals, metal variant
- 53E... for the electrical peripherals, for control cabinet installation

For VTSA:

- 44P... for the pneumatic components

For VTSA-F:

- 45P... for the pneumatic components

For VTSA-F-CB:

- 46P... for the pneumatic components

Valve terminals VTSA/VTSA-F with parallel communication and fieldbus interface can be expanded with up to 32 valves with max. 32 solenoid coils. The manifold sub-bases for valves with a width of 18 or 26 mm are suitable for either

- 2 single solenoid valves or
- 2 double solenoid valves and the manifold sub-bases for valves with a width of 42, 52 and 65 mm are suitable for
- 1 single solenoid valve or
- 1 double solenoid valve
- Double solenoid valve positions can be equipped with any valve or a cover plate.

- Single solenoid valve positions can only be equipped with single solenoid valves or a cover plate.
- The valve terminal VTSA-F-CB with serial communication can be expanded with up to 96 valves with max. 96 solenoid coils. 4 zones can be equipped with max. 24 valves/solenoid coils. Each valve position can be equipped with any valve or a cover plate. The rules for CPX apply to the equipment that can be used with the electrical peripherals CPX.

- In general:
- Max. 10 electrical modules
 - Digital inputs/outputs
 - Analogue inputs/outputs
 - Parameterisation of inputs and outputs
 - Integrated, convenient diagnostics
 - Preventive maintenance concepts

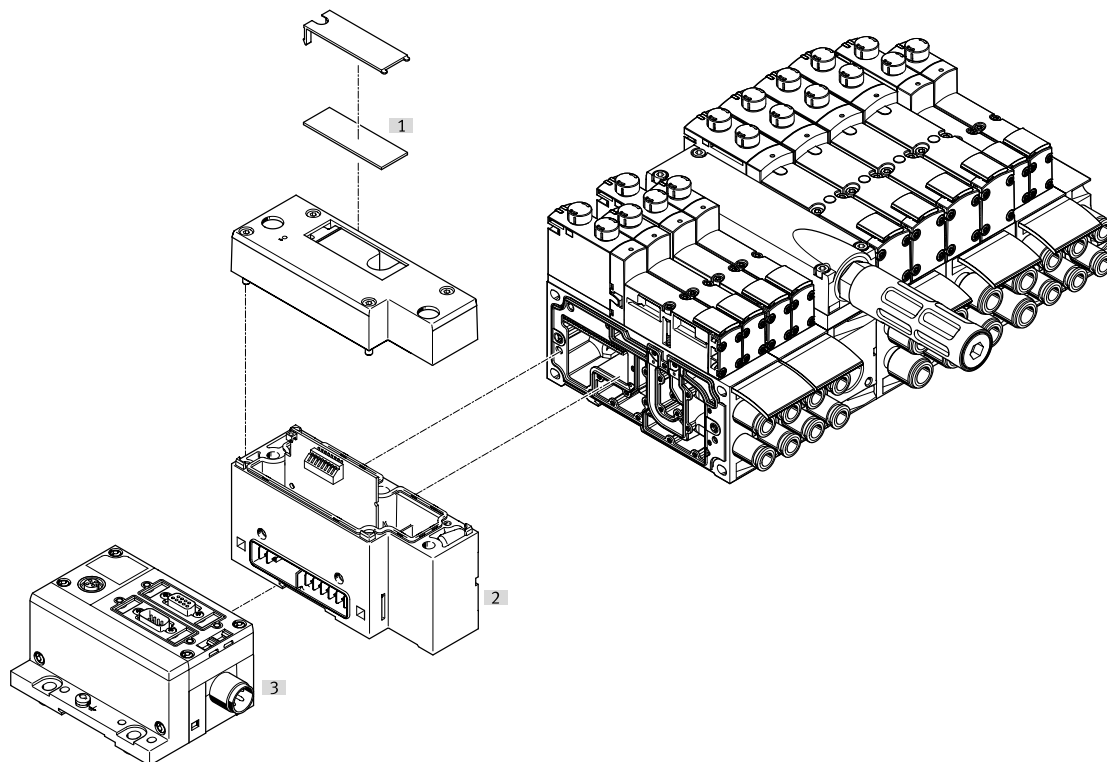

		Description	→ Page/Internet
[1]	Inscription label	Large, for pneumatic interface CPX	–
[2]	Pneumatic interface	–	155
[3]	Fieldbus interface	–	cpx

Peripherals – Electric components

Valve terminal with fieldbus/multi-pin plug connection and individually electrically actuated valve

In applications with specific emergency off conditions, it may be necessary to switch one or more valves separately from the valve terminal controller. Standard valves (VSVA) with individual electrical connection (round or square plug) are therefore mounted on the valve terminal.

In order for degree of protection IP65 to be achieved, the functionless opening in the sub-base for the electrical connection must be sealed.

A sealing cap is available for width 18 mm and 26 mm. With manifold or individual sub-bases, valves with width 42 mm and 52 mm must be used with a seal to comply with the IP degree of protection (see → page 153).

For centrally controlling the valve terminal via a multi-pin plug connection or fieldbus interface, the occupied valve position acts like a vacant position, i.e. the assigned address in the fieldbus node or the corresponding connection in the multi-pin plug connection is occupied.

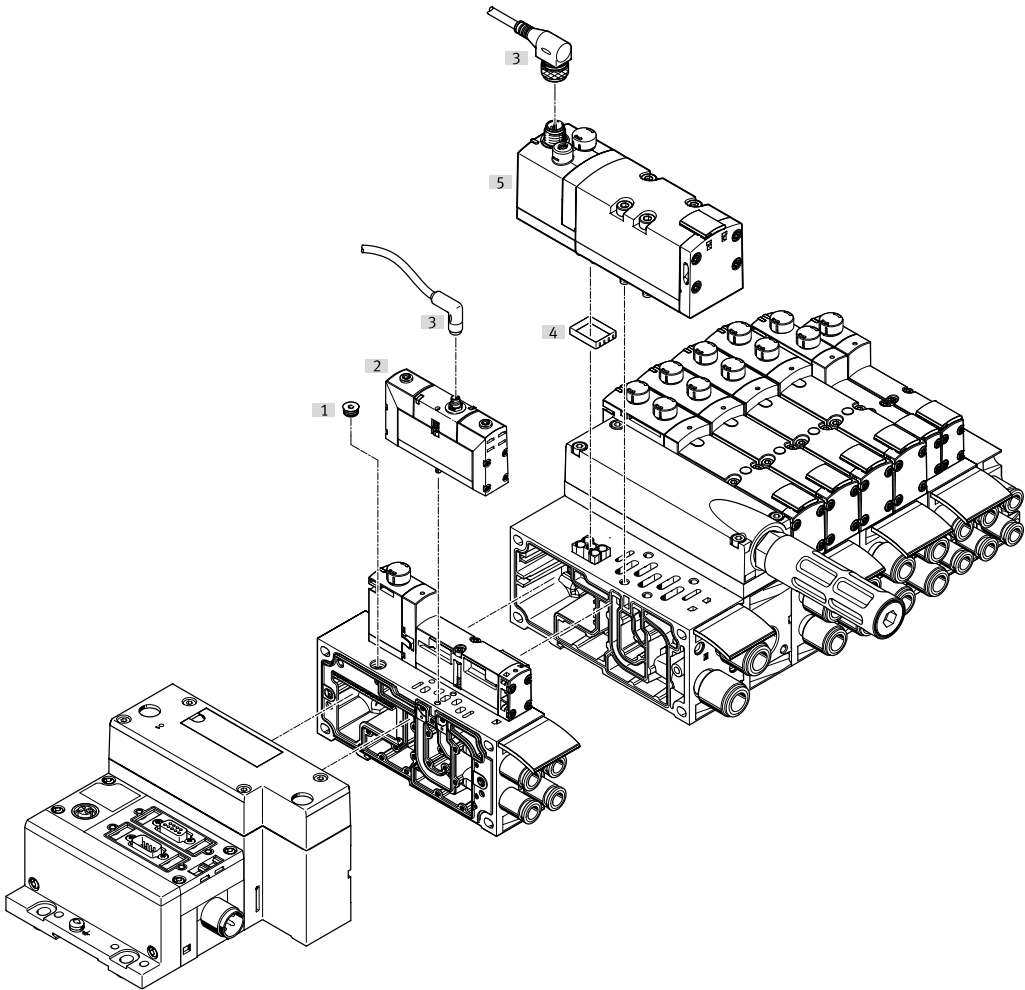

	Description	→ Page/Internet	
[1]	Sealing cap	For sealing the electrical connection on the sub-base	153
[2]	Valve	Width 18 mm or width 26 mm	valves vsva
[3]	Connecting cable	-	valves vsva
[4]	Seal	For ensuring the IP degree of protection (with width 42 mm and 52 mm)	154
[5]	Valve	Width 42 mm or width 52 mm	valves vsva

Note
 Standard valves VSVA can be used on the valve terminal. A vacant position must be provided for this in the valve terminal configurator. The appropriate standard valve VSVA can be ordered on the Internet at:
 → vsva

Key features – Pneumatic components

Manifold sub-base

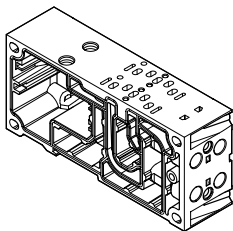

Manifold sub-bases are available for valve widths 18 mm and 26 mm in a double grid, i.e. two valves per manifold sub-base.

For VTSA-F-CB with serial communication, there are manifold sub-bases available for valve widths 18 mm and 26 mm in a double grid, as well as hybrid manifold sub-bases. Valves of width 18 mm and 26 mm can be used together on a hybrid manifold sub-base.

VTSA/VTSA-F with parallel communication is based on a modular system which consists of manifold sub-bases and valves.

The VTSA-F manifold sub-bases are designed to optimise the flow rate.

For valves with a width of 42 mm or 52 mm, there are manifold sub-bases with one valve per sub-base. The manifold sub-base contains a duct seal and an electric interlinking module. They can be freely mixed within a valve terminal.

The manifold sub-bases are screwed together and thus form the support system for the valves. Inside the manifold sub-bases are the connection ducts for supplying compressed air to and exhausting the valve terminal as well as the working ports for the pneumatic cylinders for each valve.

Each manifold sub-base is connected to the next using four screws. Individual valve terminal sections can be isolated and further manifold sub-bases can be inserted by loosening these screws. This ensures that the valve terminal can be rapidly and reliably extended.

Port patterns to ISO 15407-2

Width 18 mm (size 02)

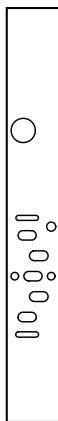

Width 26 mm (size 01)

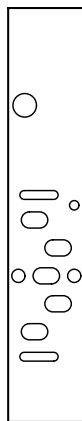

Port patterns to ISO 5599-2

Width 42 mm (size 1)

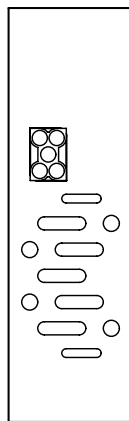

Width 52 mm (size 2)

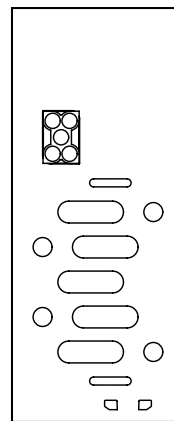

Key features – Pneumatic components

Port patterns – High-flow sub-bases with optimised flow rate (no standard)

Width 18 mm



Width 26 mm

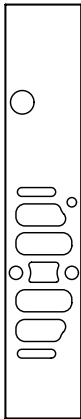

Width 42 mm

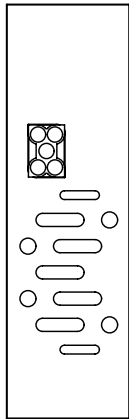

Hybrid sub-base for VTSA-F-CB:

Width 18 mm + 26 mm

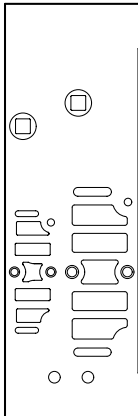

Note
The illustrations shown represent the pneumatic port patterns. The port patterns on the valve terminal VTSA-F/VTSA-F-CB and the hybrid sub-base do not correspond to the ISO standard.

Key features – Pneumatic components

Manifold sub-base variants with QS fitting, valve terminal VTSA									
Code	Image	Type	Width				No. of valve positions (solenoid coils) ¹⁾	Working ports (2, 4)	
			18 mm	26 mm	42 mm	52 mm		Code M Large	Code N Small
Manifold sub-base for double solenoid valves									
A		VABV-S4-2S-G18-2T2	■	-	-	-	2 (4)	QS-G1/8-8	-
AK							-	QS-G1/8-6	
B		VABV-S4-1S-G14-2T2	-	■	-	-	2 (4)	QS-G1/4-10	-
BK							-	QS-G1/4-8	
C		VABV-S2-1S-G38-T2	-	-	■	-	1 (2)	QS-G3/8-12	-
CK							-	QS-G3/8-10	
D	VABV-S2-2S-G12-T2	-	-	-	■	1 (2)	QS-G1/2-16	-	
DK						-	QS-G1/2-12		
Manifold sub-base for single solenoid valves									
E		VABV-S4-2S-G18-2T1	■	-	-	-	2 (2)	QS-G1/8-8	-
EK							-	QS-G1/8-6	
F		VABV-S4-1S-G14-2T1	-	■	-	-	2 (2)	QS-G1/4-10	-
FK							-	QS-G1/4-8	
G		VABV-S2-1S-G38-T1	-	-	■	-	1 (1)	QS-G3/8-12	-
GK							-	QS-G3/8-10	
H	VABV-S2-2S-G12-T1	-	-	-	■	1 (1)	QS-G1/2-16	-	
HK						-	QS-G1/2-12		

1) Value in brackets is max. number of solenoid coils that can be actuated

Key features – Pneumatic components

Manifold sub-base variants with QS fitting, valve terminal VTSA-F									
Code	Image	Type	Width				No. of valve positions (solenoid coils) ¹⁾	Working ports (2, 4)	
			18 mm	26 mm	42 mm	52 mm		Code M Large	Code N Small
Manifold sub-base for double solenoid valves									
A		VABV-S4-2HS-G18-2T2	■	-	-	-	2 (4)	QS-G1/8-8	-
AK								-	QS-G1/8-6
B		VABV-S4-1HS-G14-2T2	-	■	-	-	2 (4)	QS-G1/4-10	-
BK								-	QS-G1/4-8
C		VABV-S2-1HS-G38-T2	-	-	■	-	1 (2)	QS-G3/8-12	-
CK								-	QS-G3/8-10
D		VABV-S2-2S-G12-T2	-	-	-	■	1 (2)	QS-G1/2-16	-
DK								-	QS-G1/2-12
Manifold sub-base for double solenoid valves, hybrid sub-base									
XA		VABV-S4-12HS-G-2T2	1st valve position 18 mm + 2nd valve position 26 mm		-	-	2 (4)	Left valve position: QS-G1/8-8 QS-G1/8-10	-
XAK		<ul style="list-style-type: none"> • 1x double solenoid, width 18 mm • 1x double solenoid, width 26 mm • with small fittings 	1st valve position 18 mm + 2nd valve position 26 mm		-	-	2 (4)	Right valve position: QS-G1/4-8 QS-G1/4-10	Left valve position: QS-G1/8-6 QS-G1/8-8
Manifold sub-base for single solenoid valves									
E		VABV-S4-2HS-G18-2T1	■	-	-	-	2 (2)	QS-G1/8-8	-
EK								-	QS-G1/8-6
F		VABV-S4-1HS-G14-2T1	-	■	-	-	2 (2)	QS-G1/4-10	-
FK								-	QS-G1/4-8
G		VABV-S2-1HS-G38-T1	-	-	■	-	1 (1)	QS-G3/8-12	-
GK								-	QS-G3/8-10
H		VABV-S2-2S-G12-T1	-	-	-	■	1 (1)	QS-G1/2-16	-
HK								-	QS-G1/2-12

1) Value in brackets is max. number of solenoid coils that can be actuated

Key features – Pneumatic components

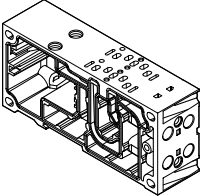
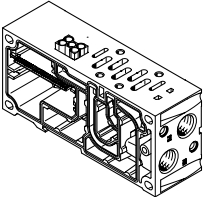
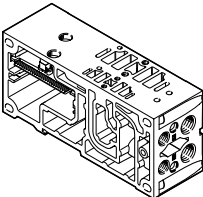
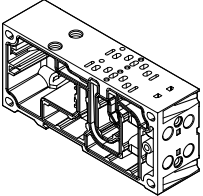
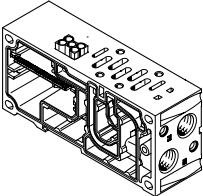
Manifold sub-base variants with increased flow rate and CBUS loop-through, valve terminal VTSA-F-CB							
Code	Image	Type	Width				No. of valve positions (solenoid coils) ¹⁾
			18 mm	26 mm	42 mm	52 mm	
Manifold sub-base for double solenoid valves							
A		VABV-S4-2HS-G18-CB-2T2	■	-	-	-	2 (4)
B		VABV-S4-1HS-G14-CB-2T2	-	■	-	-	2 (4)
C		VABV-S2-1HS-G38-CB-T2	-	-	■	-	1 (2)
D		VABV-S2-2S-G12-CB-T2	-	-	-	■	1 (2)
Manifold sub-base for double solenoid valves, hybrid sub-base							
YA		VABV-S4-12HS-G-CB-2T2 (external sensor evaluation) • 1x double solenoid, width 18 mm • 1x double solenoid, width 26 mm	■	■	-	-	2 (4)
Manifold sub-base for single solenoid valves							
E		VABV-S4-2HS-G18-CB-2T1	■	-	-	-	2 (2)
F		VABV-S4-1HS-G14-CB-2T1	-	■	-	-	2 (2)
G		VABV-S2-1HS-G38-CB-T1	-	-	■	-	1 (1)
H		VABV-S2-2S-G12-CB-T1	-	-	-	■	1 (1)

1) Value in brackets is max. number of solenoid coils that can be actuated

Key features – Pneumatic components

Manifold sub-base variants with increased flow rate and CBUS loop-through, valve terminal VTSA-F-CB							
Code	Image	Type	Width				No. of valve positions (solenoid coils) ¹⁾
			18 mm	26 mm	40 mm	52 mm	
Manifold sub-base for soft-start valve							
PV		VABV-S6-1Q-G38-CB1-T5 With CBUS loop-through and new voltage zone, for soft-start valve and pressure sensor plug-in	-	-	■	-	1
PS		VABV-S6-1Q-G38-CB-T5 With CBUS loop-through in the same voltage zone, for soft-start valve and pressure sensor plug-in	-	-	■	-	1
Manifold sub-base for pilot air switching valve							
YB		VABV-S4-2HS-G18-CB-2T5 (internal sensor evaluation for pilot air switching valve) • 1x CBUS loop-through • 1x double solenoid, with CBUS loop-through	■	-	-	-	2 (4)
YC		VABV-S4-12HS-G-CB-2T5 (internal sensor evaluation for pilot air switching valve) • 1x CBUS loop-through • 1x double solenoid, with CBUS loop-through	■	■	-	-	2 (4)

1) Value in brackets is max. number of solenoid coils that can be actuated

90°-connection plate for working ports 2 and 4								
Code	Image	Type	Width				Connections	Working ports (2, 4) on the 90°-connection plate
			18 mm	26 mm	42 mm	52 mm		
P		VABF-S4-...-A2G2-G...	■	-	-	-	2 and 4	G1/8
			-	■	-	-		G1/4
			-	-	■	-		G3/8
			-	-	-	■		G1/2

Key features – Pneumatic components

Sub-base valve

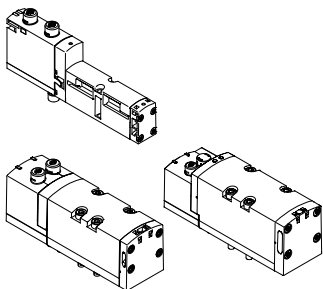

All valves are fitted with piston spool and patented sealing system, which ensures efficient sealing, a broad operating pressure range and long service life.

Sub-base valves can be quickly replaced since the tubing connections remain on the sub-base.

Irrespective of the valve function there are sub-base valves with one solenoid coil (single solenoid) or with two solenoid coils for double solenoid or double valve functions.

Reverse/vacuum operation

Select reverse operation (code Z) if you wish to operate an actuator (cylinder) with different pressures for the forward and return stroke.

Please note that the valves must then be operated via a separate pressure zone.

The reversible 3/2-way solenoid valves are also suitable for vacuum operation.

Reverse operation is only possible in pressure zones with external pilot air supply.

Note

- If a pressure zone is in reverse operation, the supply pressure is connected to port 3/5 and the air is exhausted via port 1 at all valve positions in this pressure zone.
- Reversible pressure regulators cannot be selected when a pressure zone is in reverse operation.
- With reversible pressure regulators, only the valve at this position is in reverse operation.
- When 5/3-way valves are operated in reverse, the mid-position function is changed from exhausted to pressurised and vice versa.

Cover plate

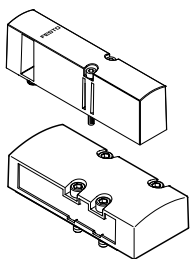

Plate without valve function for reserving valve positions on a valve terminal.

Valve and cover plates are attached to the manifold sub-base using screws.

Design

Valve replacement

The valves are attached to the metal manifold sub-base using two or four screws, which means that they can be easily replaced.

The sturdy mechanical manifold sub-base guarantees efficient long-term sealing.

Extension

Vacant positions can be fitted with valves at a later date. The dimensions, mounting points and existing pneumatic installations remain unchanged during this process.

For more information and technical data on extension, refer to the user documentation:

→ Internet: VTSA/VTSA-F

Key features – Pneumatic components

Valve function Terminal code	Circuit symbol	Valve code	Width				Description
			18 mm	26 mm	42 mm	52 mm	
VC		T22C	■	■	■	■	2x 2/2-way valve, single solenoid • Normally closed • Pneumatic spring return
VV		T22CV	■	■	■	-	2x 2/2-way valve, single solenoid • Reverse operation • Normally closed • Pneumatic spring return • Vacuum operation possible at 3 and 5
N		T32U	■	■	■	■	2x 3/2-way valve, single solenoid • Normally open • Pneumatic spring return • Operating pressure > 3 bar
K		T32C	■	■	■	■	2x 3/2-way valve, single solenoid • Normally closed • Pneumatic spring return • Operating pressure > 3 bar
H		T32H	■	■	■	■	2x 3/2-way valve, single solenoid • Normal position – 1x closed – 1x normally open • Pneumatic spring return • Operating pressure > 3 bar
P		T32F	■	■	■	■	2x 3/2-way valve, single solenoid • Reverse operation only • Normally open • Pneumatic spring return
Q		T32N	■	■	■	■	2x 3/2-way valve, single solenoid • Reverse operation only • Normally closed • Pneumatic spring return
R		T32W	■	■	■	■	2x 3/2-way valve, single solenoid • Reverse operation only • Normal position – 1x closed – 1x normally open • Pneumatic spring return

- **Note**
 A filter must be installed upstream of valves operated in vacuum mode. This prevents any foreign matter in the intake air getting into the valve (e.g. when operating a suction cup).

Key features – Pneumatic components

Valve function		Circuit symbol	Valve code	Width				Description
Terminal code				18 mm	26 mm	42 mm	52 mm	
M			M52-A	■	■	■	■	5/2-way valve, single solenoid • Reverse operation • Pneumatic spring return
O			M52-M	■	■	■	■	5/2-way valve, single solenoid • Reverse operation • Reset via mechanical spring
J			B52	■	■	■	■	5/2-way valve, double solenoid
D			D52	■	■	■	■	5/2-way valve, double solenoid • Dominant signal at port 14 on the control side
SO SQ SS			M52-M	■	-	-	-	5/2-way valve ²⁾ , single solenoid, as plug-in or via pilot valve with pneumatic interface to ISO 15218 See also special valve function in the separate chapter "Solenoid valve with switching position sensing" → Page 161
SO SQ SS			M52-M	-	■	-	-	5/2-way valve ²⁾ , single solenoid, as plug-in or via pilot valve with pneumatic interface to ISO 15218 See also special valve function in the separate chapter "Solenoid valve with switching position sensing" → Page 161
SP SN			T52-M	-	■	-	-	2x 5/2-way valve, single solenoid, with switching position sensing, pneumatically linked via two ducts for special valve function "control block with safety function" → Page 167
B			P53U	■	■	■	■	5/3-way solenoid valve • Mid-position pressurised ¹⁾ • Reset via mechanical spring
G			P53C	■	■	■	■	5/3-way solenoid valve • Mid-position closed ¹⁾ • Reset via mechanical spring
E			P53E	■	■	■	■	5/3-way solenoid valve • Mid-position exhausted ¹⁾ • Reset via mechanical spring

1) If neither solenoid coil is energised, the valve is moved to its mid-position by a mechanical spring. If the two coils are permanently energised one after the other, the valve remains in the switching position of the coil that was activated first.
2) The symbol represents a valve with a proximity switch with a switching output signal, in the illustration an N/O contact. In accordance with ISO 1219-1, this symbol applies to both N/O and N/C contacts. All sensors used here have an N/C contact as the switching element function.

Key features – Pneumatic components

Valve function		Valve code	Width				Description
Terminal code	Circuit symbol		18 mm	26 mm	42 mm	52 mm	
SA		P53ED	■	■	-	-	5/3-way solenoid valve, for special functions as switching position 14 is retained <ul style="list-style-type: none"> • Pressureless switching, self-latching loop, pneumatic operation • Mid-position exhausted, switching position 14 is retained • Reset via mechanical spring
SB		P53AD	■	■	-	-	5/3-way solenoid valve, for special functions as switching position 14 is retained <ul style="list-style-type: none"> • Holding, blocking a movement (mechanically) • Mid-position: port 2 pressurised, port 4 exhausted, switching position 14 is retained • Reset via mechanical spring
SD		P53BD	■	■	-	-	5/3-way solenoid valve, for special functions as switching position 14 is retained <ul style="list-style-type: none"> • Holding, blocking a movement (mechanically) • Mid-position: port 4 pressurised, port 2 exhausted, switching position 14 is retained • Reset via mechanical spring
SE		P53EP	■	■	-	-	5/3-way solenoid valve, for special functions as switching position 12 is retained <ul style="list-style-type: none"> • Pressureless switching, self-latching loop, pneumatic operation • Mid-position exhausted, switching position 12 is retained • Reset via mechanical spring
VG		P53F	-	-	■	■	5/3-way solenoid valve <ul style="list-style-type: none"> • Positioning • Mid-position: port 2 pressurised, port 4 closed¹⁾ • Reset via mechanical spring
VB	-	-	-	■	-	-	Vacuum generator with ejector pulse and adjustable air saving function (plate for 2 valve positions, sensor SDE3 with display and M12 connection)
L	-	-	■	■	■	■	For valve terminal only: Cover plate for vacant valve position

1) If neither solenoid coil is energised, the valve is moved to its mid-position by a mechanical spring. If the two coils are permanently energised one after the other, the valve remains in the switching position of the coil that was activated first.

Key features – Pneumatic components

Vertical stacking

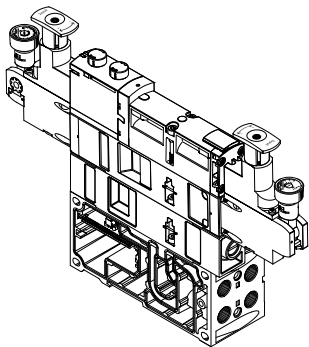

Additional function units can be added to each valve position between the sub-base (manifold sub-base) and the valve.

These functions are known as vertical stacking modules and enable special functions or control of an individual valve position. It is possible to link several valve sizes on one valve terminal.



Note

Certain combinations are not recommended due to the design of the individual vertical stacking components.

Vertical stacking components

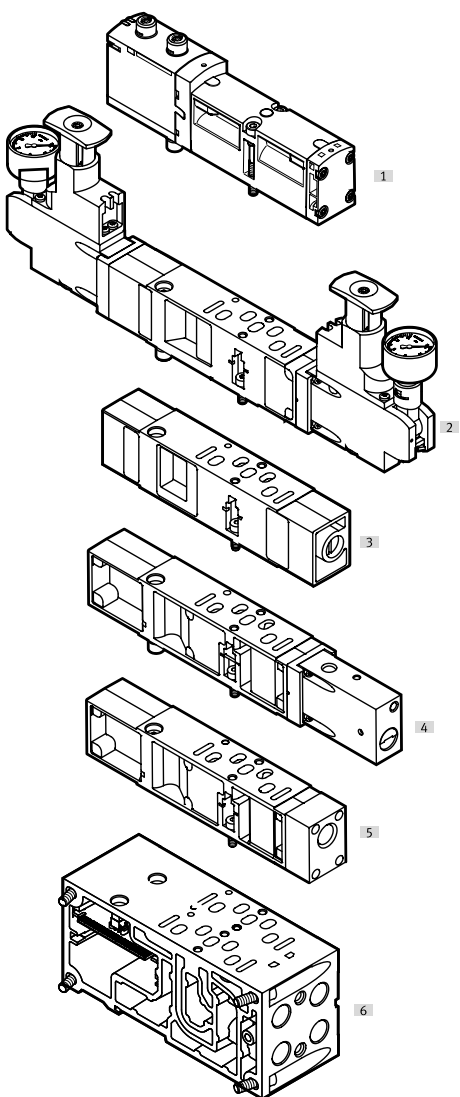

The following component sequence is recommended for valve positions with vertical stacking:

- [1] Valve VSVA
- [2] Pressure regulator plate
- [3] Throttle plate
- [4] Vertical pressure shut-off plate
- [5] Vertical supply plate
- [6] Manifold sub-base

Key features – Pneumatic components

Vertical stacking

Pressure regulator plate

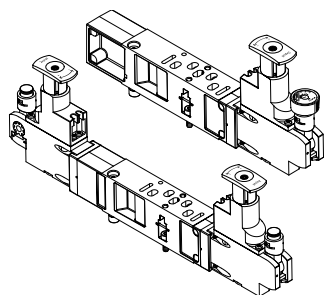

An adjustable pressure regulator can be installed between the base plate (manifold sub-base) and the valve in order to control the force of the triggered actuator.

This pressure regulator maintains a largely constant output pressure (secondary side) independent of pressure fluctuations (primary side) and air consumption. Also suitable for valves with symmetrical design.

Standard version:

- Standard port pattern to ISO 15407-2 or ISO 5599-2
- For pressure regulation up to 6 bar or up to 10 bar
- Without pressure gauge (optional)
- Regulator knob with 3 positions (locked, reference position, freely positionable)

- [Symbol] - Note

With the A, B and AB pressure regulators VABF-S...-1-..., the regulated pressure should not be less than 2 bar.

Use the reversible A, B or AB pressure regulators for regulated pressure of less than 2 bar.

- [Symbol] - Note

Please note for repeat orders of pressure regulators in sizes 42 mm and 52 mm: The part number printed on the regulator plate refers only to the standard version.

When reordering pressure regulators with additional equipment, such as an extended design, only use the VABF configurator.

→ Internet: vabf-s2

Rotary knob for pressure regulator for width 42 mm and 52 mm

Setting the pressure

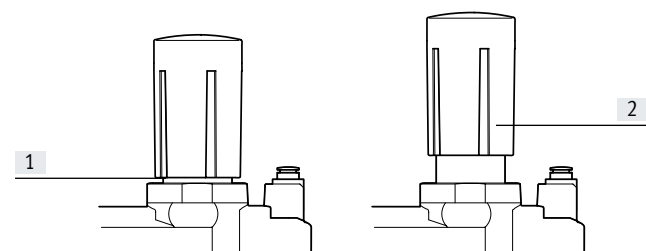

- [1] Pull the rotary knob upwards out of the locking position (1) into the setting position (2)
- [2] Set the desired pressure at the setting level (2) using the rotary knob
- [3] After setting the pressure, push the rotary knob back down to the locking position (1)

Rotary knob for pressure regulator for width 42 mm and 52 mm

Locking the rotary knob

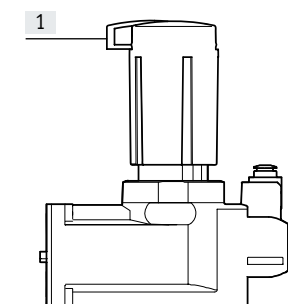

After setting the pressure, the rotary knob can be locked against unauthorised actuation.

To do this, the blue locking element is pushed out and secured with a padlock.

The rotary knob is now fixed in place and cannot be moved.

- [Symbol] - Note

The position of the rotary knob and the locking element is determined by the pressure setting.

If a number of pressure regulators are installed next to one another, there may not always be enough space to push out the locking elements.

To ensure that the rotary knob can still be locked, it can be pulled off completely, rotated 60° or 120° and pushed back on.

Further information:

→ Internet: User documentation

- [1] Locking element, pushed out

Key features – Pneumatic components

Vertical stacking

Energy efficiency through dual-pressure operation or through operation with reversible pressure regulators

Saving energy starts with compressed air generation. It is possible to achieve energy savings of up to 10% per 1 bar drop in pressure. Therefore, wherever possible reduce the pressure to the minimum required.

To save additional energy, you can operate valves in dual-pressure mode in a separate pressure zone.

To do this, the valves used must be operated in reverse mode, i.e. with reversed flow direction (see also information on → page 107). In dual-pressure operation, the valves are then supplied with pressure separately via ducts 3 and 5.

The air is exhausted via duct 1.

Requirements for dual-pressure operation:

- Exhaust ducts 3 and 5 in the pressure zone are completely separate.
- Valves are used that can be operated in reverse mode.

Advantages of dual-pressure operation:

It is possible to save energy if a valve can be supplied with different pressures. The advantages are:

- Saves energy because the return stroke can be carried out using reduced force, e.g. 3 bar instead of 6 bar.
- Just one valve is required, as in the case of vacuum application with ejector pulse for example (e.g. duct 3 for vacuum switching, duct 5 for the ejector pulse).
- A reduction in compressed air consumption of up to 50% is possible if two different pressures can be applied to the valve (return stroke uses reduced pressure).

Advantages of reversible operation:

If compressed air is applied to the pressure regulator upstream of the valve (circuit diagram 2), exhausting is directly via the solenoid valve.

This has the following advantages:

- Increased exhaust capacity, exhausting is up to 50% quicker
- Lower wear on the pressure regulator
- Can be adjusted very accurately, perfect for very low operating pressures
- No quick exhaust valves are required.
- Fast cycle times
- The pressure regulator can be adjusted independently of the valve position because operating pressure is permanently present at the pressure regulator.

Dual-pressure operation with standard regulator

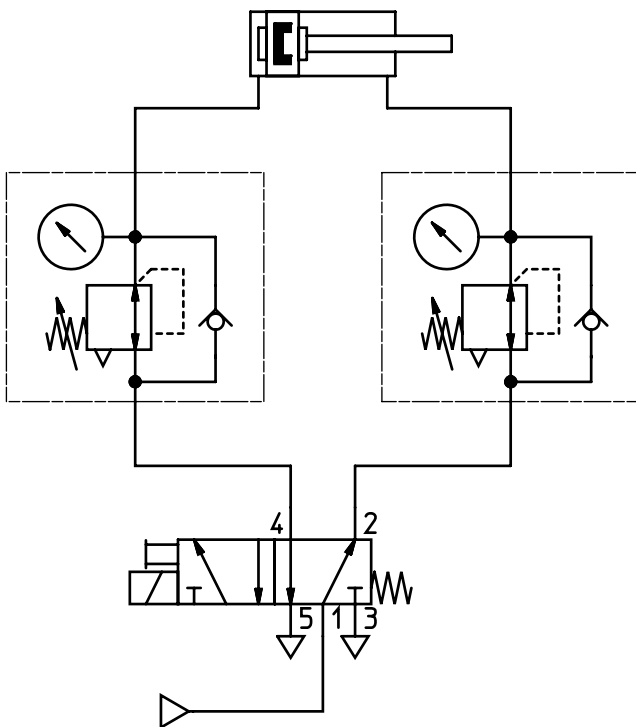

Circuit diagram 1:
Pressure is regulated downstream of the valve

Dual-pressure operation with reversible controller

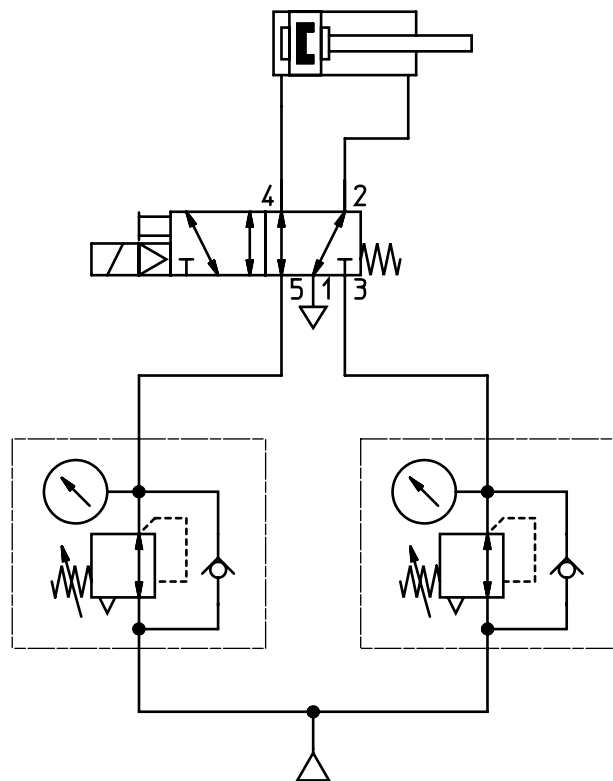

Circuit diagram 2:
Pressure is regulated upstream of the valve

Key features – Pneumatic components

Vertical stacking

Mode of operation of the pressure regulator plate (P regulator) for port 1; code: ZA, ZAY, ZF, ZFY

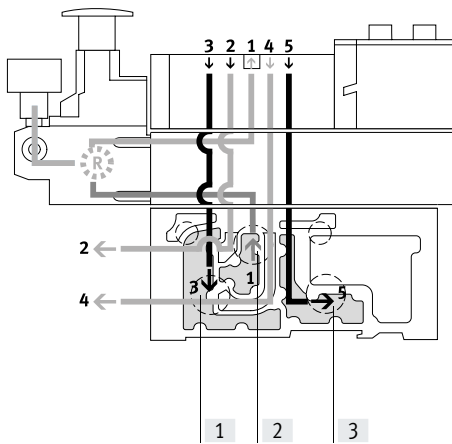

This pressure regulator regulates the pressure upstream of the valve in duct 1. Ducts 2 and 4 thus have the same regulated pressure.

During exhausting, the exhaust flow in the valve is from duct 2 to duct 3 and from duct 4 to duct 5.

- [1] Duct 3 (exhaust air)
- [2] Duct 1 (supply air)
- [3] Duct 5 (exhaust air)

Advantages

- The pressure regulator is not affected by exhausting, since the pressure is regulated upstream of the valve.
- The pressure regulator can always be adjusted, since the pressure from the valve terminal is always present.

Application examples

- An equal working pressure is required at working ports 2 and 4.
- A working pressure (e.g. 3 bar) lower than the operating pressure present at the valve terminal (e.g. 8 bar) is required.

Mode of operation of the pressure regulator plate (AB regulator) for ports 2 and 4; code: ZD, ZDY, ZI, ZIY

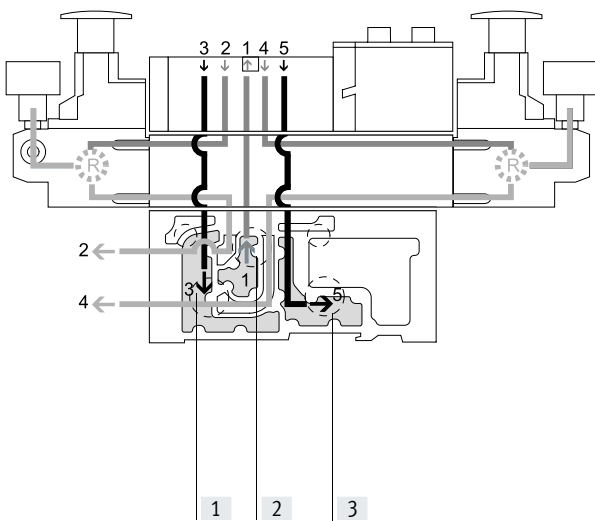

This pressure regulator regulates the pressure in ducts 2 and 4 after the pressure medium flows through the valve.

During exhausting, the exhaust flow in the valve is from duct 2 to duct 3 and from duct 4 to duct 5 via the pressure regulator.

Example with the following switching position:

The supply air flows from duct 1 of the manifold sub-base via the valve to duct 2, it is then regulated and made available at port 2 of the manifold sub-base. At the same time, exhausting takes place via duct 4 of the manifold sub-base, via the regulator and via the valve into duct 5 of the manifold sub-base.

- [1] Duct 3 (exhaust air)
- [2] Duct 1 (supply air)
- [3] Duct 5 (exhaust air)

Constraints

- The pressure regulator cannot be adjusted in the exhaust position. For example, the pressure regulator for duct 4 cannot be adjusted when the valve is pressurised in the switching position from duct 1 to duct 2 and exhausted from duct 4 to duct 5.

Application examples

- Two different working pressures are required at ports 2 and 4 instead of the valve terminal operating pressure.

Key features – Pneumatic components

Vertical stacking

Mode of operation of the pressure regulator plate (AB regulator, reversible) for ports 2 and 4, reversible; code: ZE, ZEY, ZJ, ZJY

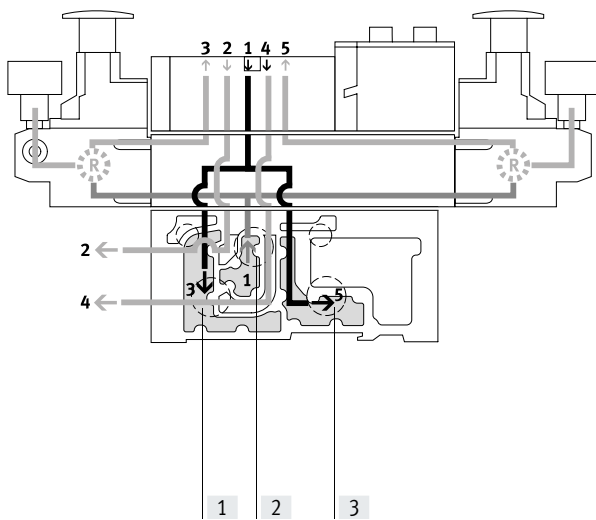

With this pressure regulator, the supply air (duct 1) is split and routed directly to both pressure regulators. In each case the regulated supply air is present in ducts 3 and 5 on the valve. The valve is thus operated in reverse mode.

This means that:

- Duct 3 routes the working pressure to port 2
- Duct 5 routes the working pressure to port 4

Example with the following switching position:

The supply air in duct 1 is split between ducts 3 and 5 in the regulator and flows from here to the valve. In the valve, the supply air is routed to port 2 of the manifold sub-base. The exhaust air is simultaneously routed via duct 4 of the manifold sub-base and via the valve to regulator duct 1, where it is split between ducts 3 and 5 and then discharged via the manifold sub-base.

- [1] Duct 3 (exhaust air)
- [2] Duct 1 (supply air)
- [3] Duct 5 (exhaust air)

Application examples

- Two different pressures are required in ducts 2 and 4 instead of the valve terminal's operating pressure.
- Quick exhausting is required.
- The pressure regulator must always be adjustable.

Note

- Reversible pressure regulator plates should only be combined with valves that can be operated in reverse mode.
- Valves in valve positions with vertical pressure shut-off plates are operated with internal pilot air, even when the valve terminal is operated with external pilot air supply.
- The following combination of reversible valve terminals with vertical stacking components is not permitted:
 - Reversible pressure regulator plates
 - Throttle plates
 - Vertical pressure shut-off plates
 - Vertical supply plates

Advantages

- Fast cycle times
- 50% higher exhaust flow rate, as air is not exhausted via the pressure regulator. The load on the pressure regulator is also reduced.
- No quick exhaust valves are required.
- Operating pressure is always present at the pressure regulator, as the pressure is regulated upstream of the valve, i.e. the regulator can always be adjusted.

Disadvantages

- 2x 3/2-way solenoid valves (code N, K, H) cannot be used, as pressure is present at ports 3 and 5.
- No practical combination with a throttle plate possible.

Key features – Pneumatic components

Vertical stacking – Pressure regulator plate, variants ¹⁾									
Code	Type	Width				Pressure regulation up to		Description	
		18 mm	26 mm	42 mm	52 mm	6 bar	10 bar		
Pressure regulator plate for port 1 (P regulator)									
ZA		VABF-S...-R1C2-C-10	■	■	■	■	–	■	Regulates the operating pressure in duct 1 upstream of the solenoid valve
ZAY ²⁾		VABF-S...-R1C2-C-10E	■	■	■	■	–	■	
ZF		VABF-S...-R1C2-C-6	■	■	■	■	■	–	
ZFY ²⁾		VABF-S...-R1C2-C-6E	■	■	■	■	■	–	
Pressure regulator plate for port 2 (B regulator)									
ZC		VABF-S...-R2C2-C-10	■	■	■	■	–	■	Regulates the operating pressure in duct 2 downstream of the solenoid valve
ZCY ²⁾		VABF-S...-R2C2-C-10E	■	■	■	■	–	■	
ZH		VABF-S...-R2C2-C-6	■	■	■	■	■	–	
ZHY ²⁾		VABF-S...-R2C2-C-6E	■	■	■	■	■	–	
Pressure regulator plate for port 4 (A regulator)									
ZB ²⁾		VABF-S...-R3C2-C-10	■	■	■	■	–	■	Regulates the operating pressure in duct 4 downstream of the solenoid valve
ZG ²⁾		VABF-S...-R3C2-C-6	■	■	■	■	■	–	
Pressure regulator plate for ports 2 and 4 (AB regulator)									
ZD		VABF-S...-R4C2-C-10	■	■	■	■	–	■	Regulates the working pressure in ducts 2 and 4 downstream of the solenoid valve
ZDY ²⁾		VABF-S...-R4C2-C-10E	■	■	■	■	–	■	
ZI		VABF-S...-R4C2-C-6	■	■	■	■	■	–	
ZIY ²⁾		VABF-S...-R4C2-C-6E	■	■	■	■	■	–	
<div style="display: flex; align-items: center;"> <p>Note These pressure regulator plates cannot be combined with reversible 2x 3/2-way solenoid valves (code P, Q, R).</p> </div>									

1) Width variants 42 mm and 52 mm (ISO 5599-2, ISO 1 and ISO 2) can be selected via the pressure regulator configurator VABF-S2
 2) Also suitable for valves with symmetrical design

Key features – Pneumatic components

Vertical stacking – Pressure regulator plate, reversible, variants ¹⁾									
Code	Type	Width				Pressure regulation up to		Description	
		18 mm	26 mm	42 mm	52 mm	6 bar	10 bar		
Pressure regulator plate for port 2, reversible (B regulator)									
ZL		VABF-S...-R6C2-C-10	■	■	■	■	–	■	Reversible pressure regulator for port 2
ZLY ²⁾		VABF-S...-R6C2-C-10E	■	■	■	■	–	■	
ZN		VABF-S...-R6C2-C-6	■	■	■	■	■	–	
ZNY ²⁾		VABF-S...-R6C2-C-6E	■	■	■	■	■	–	
Pressure regulator plate for port 4, reversible (A regulator)									
ZK ²⁾		VABF-S...-R7C2-C-10	■	■	■	■	–	■	Reversible pressure regulator for port 4
ZM ²⁾		VABF-S...-R7C2-C-6	■	■	■	■	■	–	
Pressure regulator plate for ports 2 and 4, reversible (AB regulator)									
ZE		VABF-S...-R5C2-C-10	■	■	■	■	–	■	<ul style="list-style-type: none"> • Reversible pressure regulator for ports 2 and 4 • Pressure regulation upstream of the solenoid valve • Routes the operating pressure from duct 1 to ducts 3 and 5 • Routes the exhaust air from duct 1 to ducts 3 and 5
ZEY ²⁾		VABF-S...-R5C2-C-10E	■	■	■	■	–	■	
ZJ		VABF-S...-R5C2-C-6	■	■	■	■	■	–	<p>Note</p> <p>These pressure regulator plates cannot be combined with standard 2x 3/2-way solenoid valves (code N, K, H). Reversible 2x 3/2-way solenoid valves (code P, Q, R) must not be operated in a separate pressure zone in combination with these pressure regulators.</p>
ZJY ²⁾		VABF-S...-R5C2-C-6E	■	■	■	■	■	–	

1) Width variants 42 mm and 52 mm (ISO 5599-2, ISO 1 and ISO 2) can be selected via the pressure regulator configurator VABF-S2

2) Also suitable for valves with symmetrical design

Key features – Pneumatic components

Vertical stacking

Throttle plate

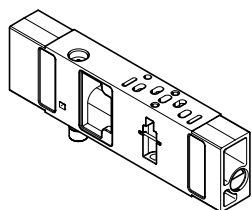

Equipped with two flow control valves at which the exhaust air flow rate at exhaust ports 3 or 5 can be adjusted.

This enables the movement of the drive to be initiated and the required speed to be set on the valve terminal using the manual override. Ducts 3 and 5 can be adjusted independently of each other.

Note
On reversible valve terminals, the air flow is controlled in ducts 3 and 5 upstream of the valve.

Code	Type	Width				Description
		18 mm	26 mm	42 mm	52 mm	
X	VABF-S4...F1B1-C	■	■	■	■	<ul style="list-style-type: none"> Controls the flow of exhaust air downstream of the valve to ducts 3 and 5

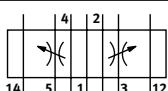

Vertical pressure shut-off plate

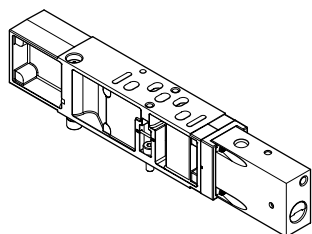

Equipped with a switch via which the compressed air supply can be shut off. This enables a solenoid directional control valve or subsequent vertical stacking plate to be replaced without switching off the overall air supply.

If the control chain has a redundant connection, the cycle can continue even in the case of a cyclical control system. Following activation of the shut-off, the exhaust air/return air from the actuated valve is expelled. This takes place via an M5 threaded connection or via duct 3 in the case of width 18 and 26 mm, and via duct 3 in the case of width 42 and 52 mm.

Note
The operating pressure of the valve terminal must lie within the range of the required pilot pressure (i.e. min. 3 bar). When using the end plate with pilot air selector, only the switching position with code W and U can be used.

Code	Type	Width				Description
		18 mm	26 mm	42 mm	52 mm	
ZT	VABF-S4...L1D1-C	■	■	-	-	<ul style="list-style-type: none"> 3/2-way valve for shutting off the operating pressure at the valve position Blocks ducts 1 and 14 for the valve position Supplies the valve position with internal pilot air Pressure separation at the valve assembly
	VABF-S2...L1D1-C	-	-	■	■	
ZS	VABF-S...L1D2-C	■	■	-	-	<ul style="list-style-type: none"> 3/2-way valve for shutting off the operating pressure at the valve position Blocks ducts 1 and 14 for the valve position Supplies the valve position with internal pilot air Pressure separation can be shut off on the valve assembly using a key

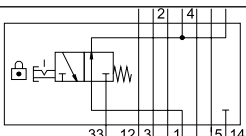
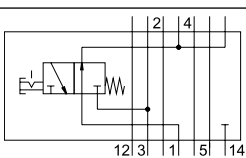
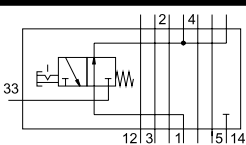

Note

The vertical pressure shut-off plates VABF... are provided only in combination with VSVA...T1L solenoid valves from Festo. In the vertical pressure shut-off plate only ducts 1 and 14 are blocked, and not duct 12.

Key features – Pneumatic components

Vertical supply plate

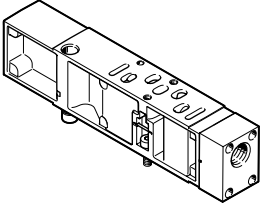

This plate enables a valve to be supplied with individual operating pressure independently of the operating pressure of the valve terminal.

As additional pressure supply for a valve. To supply an additional pressure zone.

Code	Type	Width				Description
		26 mm	18 mm	42 mm	52 mm	
ZU	VABF-S-...P1A3-...	■	■	■	■	<ul style="list-style-type: none"> Plate with port 11 for supplying individual operating pressure to a valve position, duct 1
ZV	VABF-S-...P1A14-...	■	■	■	■	<ul style="list-style-type: none"> Plate with port 11 for supplying individual operating pressure to a valve position, ducts 1 and 14

Key features – Pneumatic components

Compressed air supply and exhausting

Right end plate, internal pilot air supply

Connection size G1/2 right end plate ducts 1/3/5

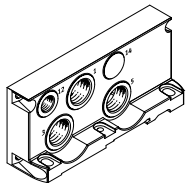

- VTSA/VTSA-F
- Code V (port 14 is not available)
- VTSA-F-CB
- Code NS

Connection size G3/4 right end plate ducts 1/3/5

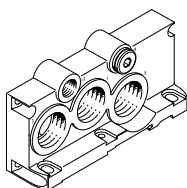

- VTSA/VTSA-F
- Code V1, V3 (port 14 is sealed with a blanking plug)
- VTSA-F-CB
- Code MS

Right end plate, external pilot air supply

Connection size G1/2 right end plate ducts 1/3/5

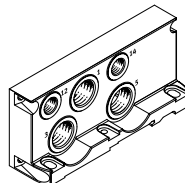

- VTSA/VTSA-F
- Code X
- VTSA-F-CB
- Code NZ

Connection size G3/4 right end plate ducts 1/3/5

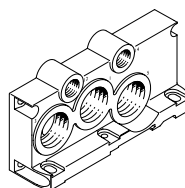

- VTSA/VTSA-F
- Code X1, X3
- VTSA-F-CB
- Code MZ

Right end plate with pilot air selector

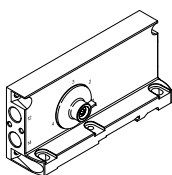

- VTSA/VTSA-F
- Code Z, Y, W, U
 - Code Z: selector position 1, external pilot air supply
 - Code Y: selector position 2, internal pilot air supply
 - Code W: selector position 3, external pilot air supply (ducted)
 - Code U: selector position 4, internal pilot air supply (ducted)

- VTSA-F-CB
- Code YZ: selector position 1, external pilot air supply
 - Code YS: selector position 2, internal pilot air supply

The valve terminal VTSA/VTSA-F/VTSA-F-CB can be supplied with pressure at one or more points. This is a reliable way of ensuring that all functional components will always offer good performance, even with large-scale extensions.

The valve terminal is generally supplied via supply plates (max. 16 per valve terminal) and/or via the right end plate.

Exhausting is either via silencers or ports for ducted exhaust air on the supply plates and/or on the right end plate.

Key features – Pneumatic components

Compressed air supply and exhausting

Supply plates for VTSA/VTSA-F, exhaust port 3/5 separate

- Code K

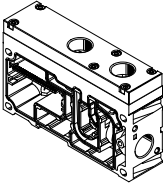

Supply plates for VTSA/VTSA-F, exhaust port 3/5 common

- Code L

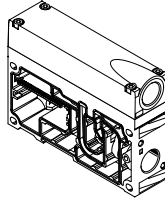

Supply plates/extension module, pneumatic and electric air supply plate for VT-SA-F-CB, exhaust port 3/5 separate

- Code U
- Code UW
- Code UWS

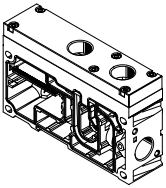

Supply plates/extension module, pneumatic and electric air supply plate for VT-SA-F-CB, exhaust port 3/5 common

- Code U
- Code UW
- Code UWS

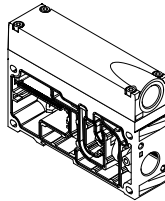

Key features – Pneumatic components

Additional compressed air supply/duct separation, VTSA/VTSA-F

Additional supply plates can be used to ensure the compressed air supply for larger valve terminals or to create additional pressure zones. These can be selected at any point upstream or downstream of the manifold sub-bases.

- Supply plates contain the ports:
- Compressed air supply (1)
 - Exhaust port (3/5) common or separate

Depending on your order, the exhaust air ducts are either ducted or exhausted via silencers.

Operation with ducted exhaust air:
With ducted exhaust air, venting can be via a supply plate or a right end plate (code V or X).

If duct separation is required, there are a number of different options:

- Duct separation 1, 3, 5: code S
- Duct separation 1: code T
- Duct separation 3, 5: code R

If a combination of duct separation (S, T or R) and one or two supply plates is required, the following variants can be selected:

- Supply plate with duct separation on the left: code SU, TU, RU
- Supply plate with duct separation on the right: code US, UT, UR
- 2 supply plates with intermediate duct separation: code USU, UTU, URU.

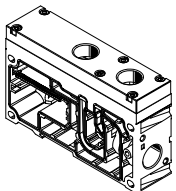
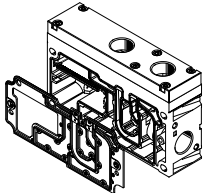
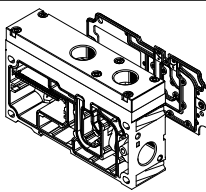
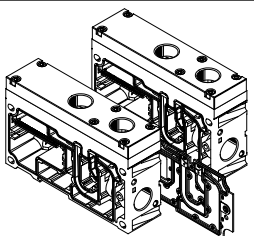
Supply plates for VTSA/VTSA-F		Type	Description
Code			
U		<ul style="list-style-type: none"> • Exhaust port 3/5 common (not illustrated) • VABFS6-10-P1A7-G12 • Exhaust port 3/5 separate • VABFS6-10-P1A6-G12 	Supply plate without duct separation (no R, S or T selected)
SU TU RU			Supply plate with duct separation on the left, if R, S or T is selected
US UT UR			Supply plate with duct separation on the right, if R, S or T is selected
USU UTU URU			2 supply plates with duct separation in centre, if R, S or T selected

Key features – Pneumatic components

Additional compressed air supply/duct separation, VTSA-F-CB

Additional supply plates can be used to ensure the compressed air supply for larger valve terminals or to create additional pressure zones. These can be selected at any point upstream or downstream of the manifold sub-bases.

Supply plates contain the ports:

- Compressed air supply (1)
- Exhaust port (3/5) common or separate

Depending on your order, the exhaust air ducts are either ducted or exhausted via silencers.

Operation with ducted exhaust air:
With ducted exhaust air, venting can be via a supply plate or a right end plate (code V or X).
If duct separation is required, there are a number of different options:

- Duct separation 1, 14: code TL
- Duct separation 1, 3, 5, 14: code K
- Duct separation 14: code L
- Duct separation 1, 3, 5: code S
- Duct separation 1: code T
- Duct separation 3, 5: code R

Supply plates, extension module and pneumatic and electric air supply plate for VTSA-F-CB

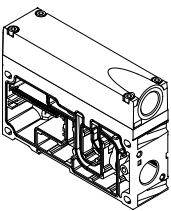
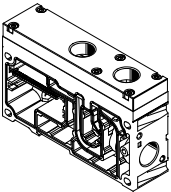
Code	Type	Description
U	 <ul style="list-style-type: none"> • Exhaust port 3/5 common • VABF-S6-1-P1A7-G12-CB 	Additional pneumatic supply Connecting thread G1/2
UW		Additional pneumatic and electrical supply Connecting thread G1/2 Generation of 24 additional valve addresses (electrical supply is provided internally from Uval)
UWS		Additional pneumatic and electrical supply Connecting thread G1/2 Generation of 24 additional valve addresses (electrical supply is provided from new (safe) voltage zone (internally from S2))
U	 <ul style="list-style-type: none"> • Exhaust port 3/5 separate • VABF-S6-1-P1A6-G12-CB 	Additional pneumatic supply Connecting thread G1/2
UW		Additional pneumatic and electrical supply Connecting thread G1/2 Generation of 24 additional valve addresses (electrical supply is provided internally from Uval)
UWS		Additional pneumatic and electrical supply Connecting thread G1/2 Generation of 24 additional valve addresses (electrical supply is provided from new (safe) voltage zone (internally from S2))

Key features – Pneumatic components

Right end plate

Right end plates with different port sizes are available depending on the flow rate required.

With the following right end plates, the outlet direction of the ports is aligned with the horizontal stacking direction. Right end plates with pilot air supply/pilot exhaust air (VTSA/VTSA-F)

- Internal pilot air supply: code V, V1 and V3 (ducts 1 and 14 are connected)
- External pilot air supply: code X, X1 and X3, as well as XP1, XP2, XP3 and XS

Right end plates with pilot air supply/pilot exhaust air (VTSA-F-CB)

- Internal pilot air supply: code NS, MS (ducts 1 and 14 are connected)
- External pilot air supply: code NZ, MZ

For end plates with pilot air selector, the outlet direction of the ports is to the front of the valve terminal. This means that all the ports on the valve terminal can be combined in one outlet direction.

The special feature of the end plates with pilot air selector is the selector switch itself, which has four settings for different pilot air supply/pilot exhaust air.

End plates with pilot air selector switch set at the factory for:

- External pilot air supply: selector position 1 (code Z)
- Internal pilot air supply: selector position 2 (code Y)
- External pilot air supply, ducted pilot exhaust air: selector position 3 (code W)
- Internal pilot air supply, ducted pilot exhaust air: selector position 4 (code U)



Note

- The end plate with pilot air selector must be used in combination with a supply plate.
- The reversible 3/2-way solenoid valves (code P, Q, R) must only be operated in selector position 1 or 2.
- Ducted pilot exhaust air via port 12 is only possible with rotated seals on the valve.

Right end plate, variants						
Code VTSA/VTSA-F	Code VTSA-F-CB	Blanking plug in duct	Pilot air supply	Ducted pilot exhaust air ¹⁾ Position of seal on solenoid valve ("ISO" is visible)	Connecting thread	
					1, 3, 5	12, 14
V	NS	–	Internal	–	G1/2	G1/4
V1	MS	–		–	G3/4	G1/4
V3	–	–		■	G3/4	G1/4
X	NZ	–	External	–	G1/2	G1/4
X1	MZ	–		–	G3/4	G1/4
X3	–	–		■	G3/4	G1/4
XP1 ²⁾	NZAB	1	External, via soft-start valve ("gradual pressure build-up")	–	G1/2	G1/4
XP2 ³⁾	NZABCB	1, 14		–	G1/2	G1/4
XP3 ³⁾	NZABCGB	1, 3, 5, 14		–	G1/2	G1/4
XS ⁴⁾	NZCB	14	External, via pilot air switching valve ("switchable pilot air")	–	G1/2	G1/4

- 1) Pilot exhaust air is ducted on the end plate via port 12 and exhausted (done by turning the seal on the solenoid valve to position "ISO")
- 2) Not possible in combination with soft-start valve code PQ, PP, PO (with internal pilot air supply)
- 3) Not possible in combination with soft-start valve code PN, PM, PK (with external pilot air supply)
- 4) Only possible in combination with pilot air switching valve code SS with intermediate plate code ZO

Right end plate with pilot air selector						
Code VTSA/VTSA-F	Code VTSA-F-CB	Pilot air supply	Selector position	Ducted pilot exhaust air ¹⁾ Position of seal on solenoid valve ("ISO" is visible)	Connecting thread 12, 14	
Z	YZ	External	1	–	G1/4	
Y	YS	Internal	2	–	G1/4	
W	–	External (ducted)	3	■	G1/4	
U	–	Internal (ducted)	4	■	G1/4	

- 1) Pilot exhaust air is ducted on the end plate via port 12 and exhausted (done by turning the seal on the solenoid valve to position "ISO")

Key features – Pneumatic components

Right end plate				
Code	Code	Type of compressed air supply and pilot air supply		Description
VTSA/VTSA-F	VTSA-F-CB			
Right end plate (graphical representation)				
V	NS			<p>Internal pilot air supply</p> <ul style="list-style-type: none"> Pilot air supply is branched internally from port 1 Port 14 is not available with code V Port 14 is sealed with a blanking plug for code V1, V3 Exhaust air via ports 3 and 5 For operating pressure in the range 3 ... 10 bar Pilot exhaust air via port 12¹⁾ V1 cannot be selected in combination with a soft-start valve in the last pressure zone
V1	MS			
V3	–			
X	NZ			<p>External pilot air supply</p> <ul style="list-style-type: none"> Pilot air supply between 2 and 10 bar is connected at port 14 Exhaust air via ports 3 and 5 For operating pressure in the range –0.9 ... 10 bar (suitable for vacuum) Pilot exhaust air via port 12¹⁾ X1 cannot be selected in combination with a soft-start valve in the last pressure zone
X1	MZ			
X3	–			
XP1	NZAB			<p>External pilot air supply, compressed air supply via soft-start valve²⁾</p> <ul style="list-style-type: none"> Port 1 is sealed with a blanking plug Exhaust air via ports 3 and 5 Pilot exhaust air via port 12¹⁾
XP2	NZACB			
XP3	NZABCGB			
XP2	NZACB			<p>External pilot air supply, compressed air supply via soft-start valve²⁾</p> <ul style="list-style-type: none"> Internal pilot air supply 14 via soft-start valve Ports 1 and 14 are sealed Exhaust air via ports 3 and 5 Pilot exhaust air via port 12¹⁾
XP3	NZABCGB			
XP3	NZABCGB			
XS	NZCB			<p>External pilot air supply via pilot air switching valve³⁾</p> <ul style="list-style-type: none"> Internal pilot air supply 14 via pilot air switching valve Port 14 is sealed Exhaust air via ports 3 and 5 Pilot exhaust air via port 12¹⁾
XS	NZCB			
XS	NZCB			

1) Ducted pilot exhaust air is only possible with rotated seals on the valve
 2) Application with XP1, XP2, XP3 and soft-start valve in combination with valves of width 52 mm: please note the maximum flow rate of the soft-start valve in this pressure zone
 3) Application with XS and pilot air switching valve in combination with intermediate plate

Key features – Pneumatic components

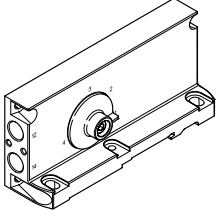
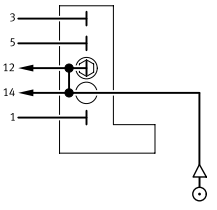
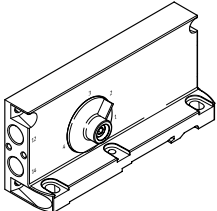
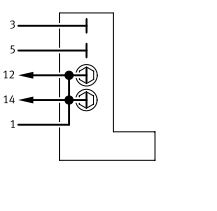
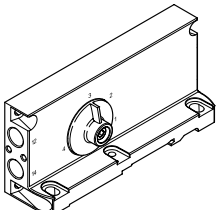
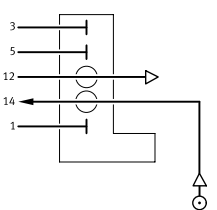
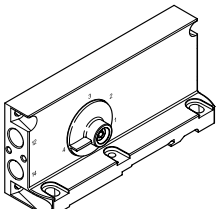
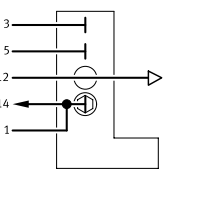
Right end plate				
Code ¹⁾	Code	Type of compressed air supply and pilot air supply		Description
VTSA/VTSA-F	VTSA-F-CB			
End plate with pilot air selector				
Z (1)	YZ			<p>External pilot air supply</p> <ul style="list-style-type: none"> Pilot air supply is connected at port 14 Port 12 is sealed with a blanking plug Ports 12 and 14 are internally connected Pilot exhaust air unducted via valve housing
Y (2)	YS			<p>Internal pilot air supply</p> <ul style="list-style-type: none"> Pilot air supply is branched internally from port 1 Ports 1, 12 and 14 are internally connected Ports 12 and 14 are sealed with blanking plugs Pilot exhaust air unducted via valve housing
W (3)	-			<p>External pilot air supply, ducted pilot exhaust air</p> <ul style="list-style-type: none"> Pilot air supply is connected at port 14 Pilot exhaust air via port 12 ²⁾ Cannot be selected in combination with a soft-start valve in the last pressure zone
U (4)	-			<p>Internal pilot air supply, ducted pilot exhaust air</p> <ul style="list-style-type: none"> Pilot air supply is branched internally from port 1 Ports 1 and 14 are internally connected Port 14 is sealed with a blanking plug Pilot exhaust air via port 12 ²⁾ Cannot be selected in combination with a soft-start valve in the last pressure zone

1) Selector setting in brackets
 2) Ducted pilot exhaust air is only possible with rotated seals on the valve (pilot exhaust air 82/84 including venting air for valves)

Note
 The reversible 3/2-way solenoid valves (code P, Q, R) must only be operated in selector position 1 or 2.

Key features – Pneumatic components

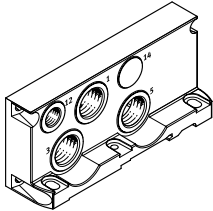
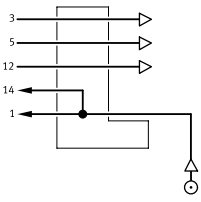
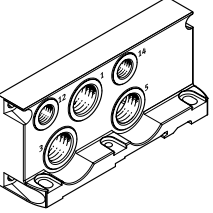
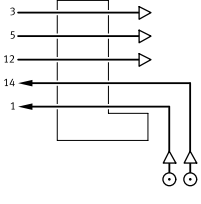
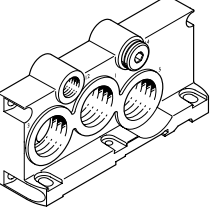
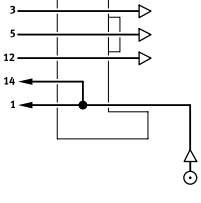
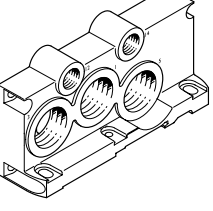
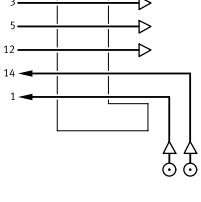
Configuration of all pneumatic threaded connections				Connection (duct)	Designation	Code M Push-in connector, large	Code N Push-in connector, small
Code VTSA/VTSA-F	Code VTSA-F-CB						
Right end plate							
V	NS			1	Push-in fitting	QS-G1/2-16	QS-G1/2-12
				3 and 5	Silencers or Push-in fitting	U-1/2-B or QS-G1/2-16	U-1/2-B or QS-G1/2-12
				12	Silencers or Push-in fitting	U-1/4 or QS-G1/4-10	U-1/4 or QS-G1/4-8
X	NZ			1	Push-in fitting	QS-G1/2-16	QS-G1/2-12
				3 and 5	Silencers or Push-in fitting	U-1/2-B or QS-G1/2-16	U-1/2-B or QS-G1/2-12
				12	Silencers or Push-in fitting	U-1/4 or QS-G1/4-10	U-1/4 or QS-G1/4-8
V1 V3	MS –			1	Barbed hose fitting	N-3/4-P-19 ¹⁾	–
				3 and 5	Silencers or Barbed hose fitting	U-3/4-B or N-3/4-P-19 ¹⁾	–
				12	Silencers or Push-in fitting	U-1/4 or QS-G1/4-12	U-1/4 or QS-G1/4-10
X1 X3	MZ –			1	Barbed hose fitting	N-3/4-P-19 ¹⁾	–
				3 and 5	Silencers or Barbed hose fitting	U-3/4-B or N-3/4-P-19 ¹⁾	–
				12	Silencers or Push-in fitting	U-1/4 or QS-G1/4-12	U-1/4 or QS-G1/4-10
				14	Plug	B-1/4	B-1/4
				14	Push-in fitting	QS-G1/4-12	QS-G1/4-10

1) For tubing with I.D. 19 mm. Use tubing clips to DIN 3017

Key features – Pneumatic components

Configuration of all pneumatic threaded connections				Connection (duct)	Designation	Code M Push-in connector, large	Code N Push-in connector, small
Code ¹⁾ VTSA/VTSA-F	Code VTSA-F-CB						
End plate with pilot air selector							
Z (1)	YZ			12	Blanking plug	B-1/4	B-1/4
				14	Push-in fitting	QS-G1/4-10	QS-G1/4-8
Y (2)	YS			12	Blanking plug	B-1/4	B-1/4
				14	Blanking plug	B-1/4	B-1/4
W (3)	-			12	Silencers or Push-in fitting	U-1/4 or QS-G1/4-10	U-1/4 or QS-G1/4-8
				14	Push-in fitting	QS-G1/4-10	QS-G1/4-8
U (4)	-			12	Silencers or Push-in fitting	U-1/4 or QS-G1/4-10	U-1/4 or QS-G1/4-8
				14	Blanking plug	B-1/4	B-1/4

1) Selector setting in brackets

Key features – Pneumatic components

Using the seals with ducted/unducted pilot exhaust air

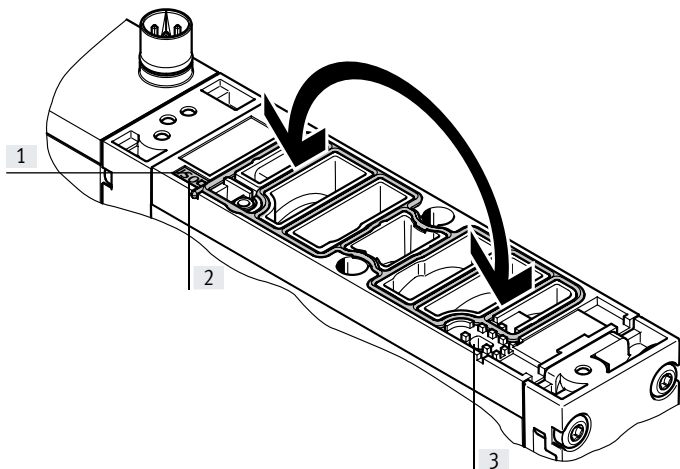

Unducted pilot exhaust air:

- The seal is visible in the display window on control side 14.
- The "ISO" mark is visible on the inscription label on the seal surface.

Ducted pilot exhaust air:

- The seal is visible in the display window on control side 12.
- The "ISO" mark is visible on the inscription label on the seal surface.

- [1] Inscription label
- [2] Display window on control side 14 ("ISO" is visible)
- [3] Display window on control side 12 ("ISO" is visible)

Designation	ISO	ISO
Pilot exhaust air	Ducted	Unducted (standard)
Display window on	Control side 12	Control side 14
Pilot exhaust port	12	-

Pilot air supply

The port for the pneumatic supply is located on the supply plates or the right end plate.

The ports differ for the following types of pilot air supply:

- Internal
- External

Internal pilot air supply

Internal pilot air supply can be selected if the working pressure is between 3 and 10 bar.

In this case the pilot air supply is branched from the compressed air supply 1 using an internal connection. Port 14 is not available with code V and is sealed with a blanking plug for code V1, V3.

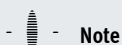

Note

If a gradual pressure build-up is required in the system by using a soft-start valve, then external pilot air should be selected so that the pilot pressure is already applied in full at the point of switch-on.

External pilot air supply

If the supply pressure is less than 3 bar, you must operate your valve terminal VTSA/VTSA-F/VTSA-F-CB using external pilot air supply.

The pilot air supply is then supplied via port 14 on the right end plate. This is the case even if the valve terminal is operated with different pressure zones.

Key features – Pneumatic components

Creating pressure zones and separating exhaust air

The valve terminal VTSA/VTSA-F/VTSA-F-CB offers a number of options for creating pressure zones if different working pressures are required. Pressure zones are created by isolating the internal supply ducts between the manifold sub-bases by appropriate duct separation.

Compressed air is supplied and exhausted via a supply plate. The position of the supply plates and duct separations can be freely selected for VTSA/VTSA-F/VTSA-F-CB.

Duct separations are integrated ex-works as per your order. Duct separations can be distinguished by their coding, even when the valve terminal is assembled.

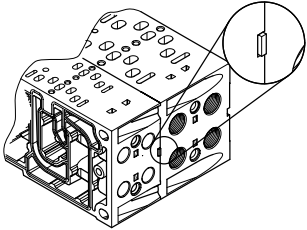

Creating pressure zones		Width						Description
Code	Separating seal	Coding	Basic representation	18 mm	26 mm	42 mm	52 mm	
T				■	■	■	■	Duct 1 separate
S				■	■	■	■	Ducts 1, 3 and 5 separate
R				■	■	■	■	Ducts 3 and 5 separate
TL		Colour-coded in red		■	■	■	■	Duct 1 and 14 separated
K		Colour-coded in green		■	■	■	■	Ducts 1, 3, 5 and 14 separate
L		Colour-coded in white		■	■	■	■	Duct 14 separate

Key features – Pneumatic components

Example: Compressed air supply and pilot air supply, right end plate

Internal pilot air supply, silencer/ducted exhaust air

Right end plate: code V and V1

The adjacent diagram shows an example of the configuration and connection of the compressed air supply with internal pilot air supply:

- Port 14 is not present with code V and is sealed with a blanking plug for code V1.
- The air is exhausted via the silencer at exhaust port 3/5.
- Duct separations can optionally be used to create pressure zones.

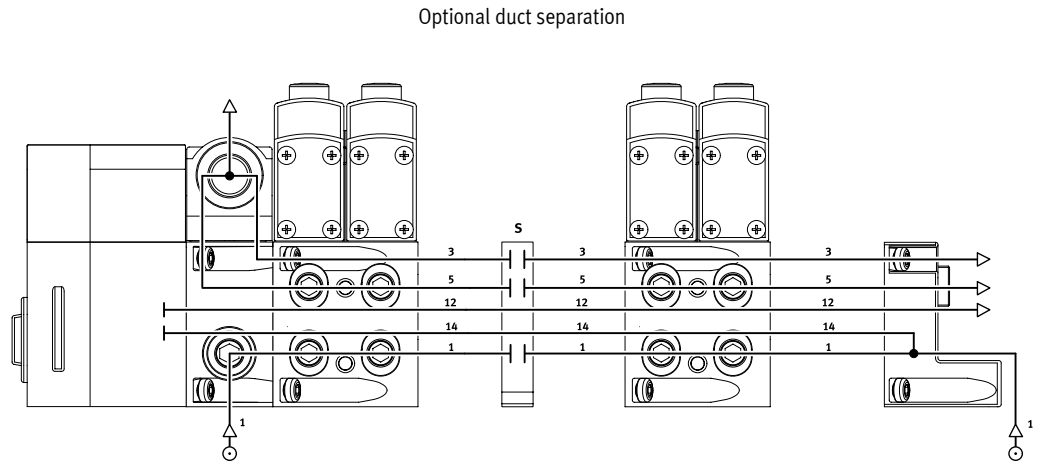

Example: Compressed air supply and pilot air supply, right end plate

External pilot air supply, silencer/ducted exhaust air

Right end plate: code X and X1

The adjacent diagram shows an example of the configuration and connection of the compressed air supply with external pilot air supply:

- Port 14 on the right end plate is equipped with a fitting for this.
- The air is exhausted via the silencer at exhaust port 3/5.
- Duct separations can optionally be used to create pressure zones.

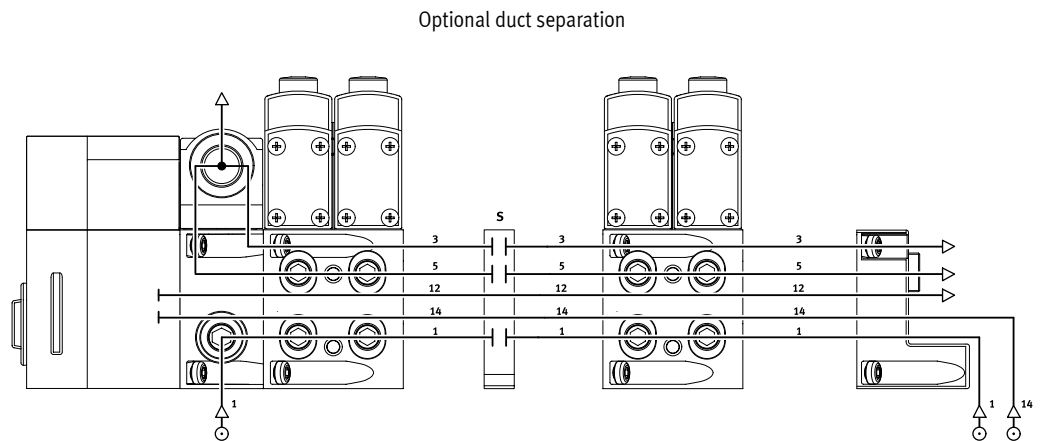

Key features – Pneumatic components – Compressed air supply and pressure zones, examples

Example: Compressed air supply and pilot air supply via end plate with pilot air selector

Internal pilot air supply, ducted exhaust air/silencer

Right end plate: code U

Optional duct separation

The adjacent diagram shows an example of the configuration and connection of the compressed air supply with internal pilot air supply:

- Port 14 on the right end plate is tightly sealed.
- The air is ducted or discharged via the silencer at exhaust port 3/5.
- The selector switch on the pilot air selector is in position 4.
- Duct separations can optionally be used to create pressure zones.

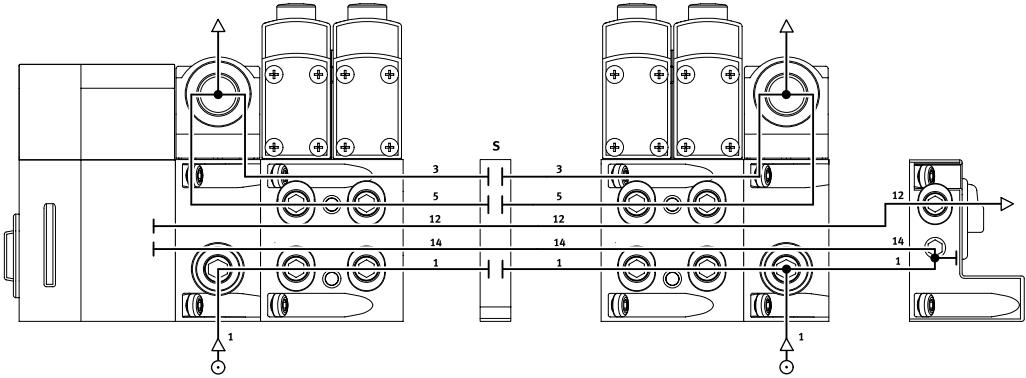

Example: Compressed air supply and pilot air supply via end plate with pilot air selector

External pilot air supply, ducted exhaust air/silencer

Right end plate: code Z

Optional duct separation

The adjacent diagram shows an example of the configuration and connection of the compressed air supply with external pilot air supply:

- Port 14 on the right end plate is equipped with a fitting for this.
- Port 12 is sealed with a blanking plug since it is internally connected with port 14.
- The air is ducted or discharged via the silencer at exhaust port 3/5.
- The selector switch on the pilot air selector is in position 1.
- Duct separations can optionally be used to create pressure zones.

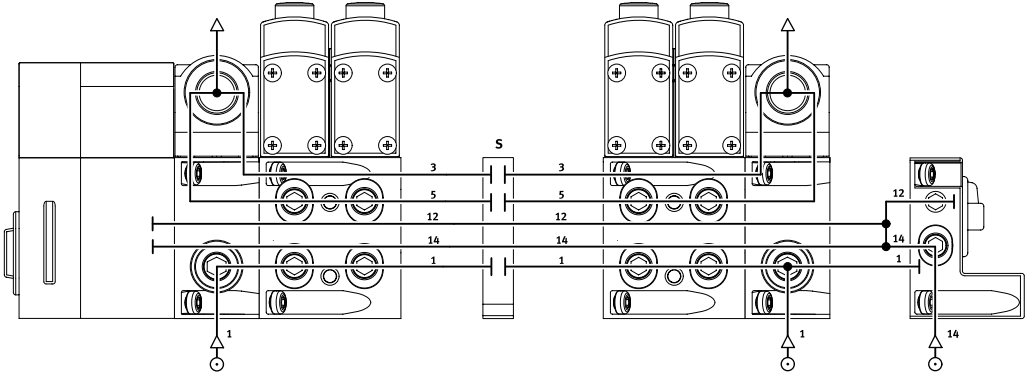

Key features – Pneumatic components – Compressed air supply and pressure zones, examples

Examples: Creating pressure zones
 VTSA/VTSA-F/VTSA-F-CB with CPX terminal

With the VTSA/VTSA-F/VTSA-F-CB up to 16 pressure zones can be created (up to 32 pressure zones if only size 1, ISO 5599-2, is fitted). The diagram shows an example of the configuration and connection of three pressure zones using duct separations – with internal pilot air supply.

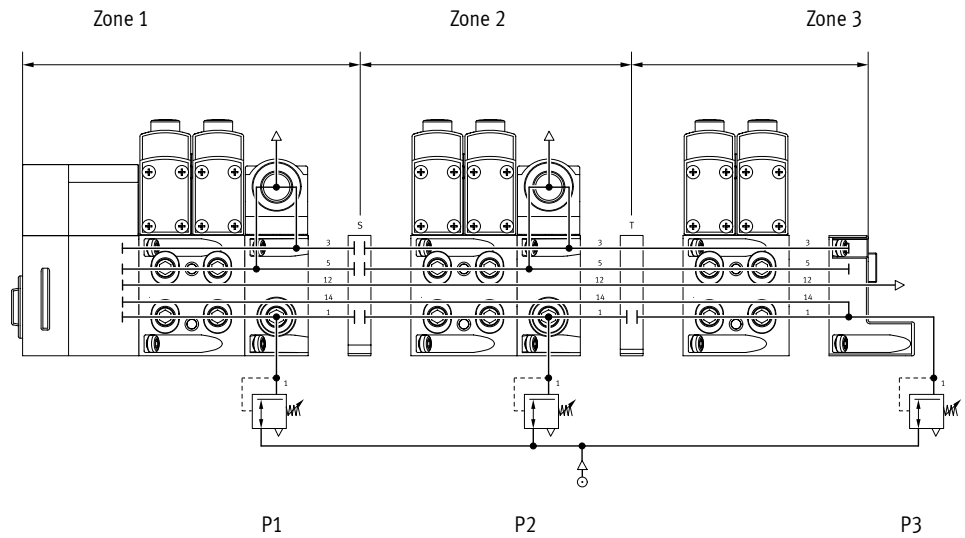

Note

Examples with pressure zones and soft-start valve are described separately in the chapter "Soft-start valve" → page 197.

Key features – Mounting

Valve terminal mounting

Sturdy valve terminal mounting thanks to:

- Through-holes for wall mounting
- Additional mounting brackets
- H-rail mounting for VTSA/VTSA-F (horizontal mounting position permitted)



Note

Further information on mounting the valve terminal, arranged by valve terminal configuration, can be found on the catalogue DVD or online.

→ Internet: 2D/3D-CAD

→ www.festo.com/sp

Wall mounting, general

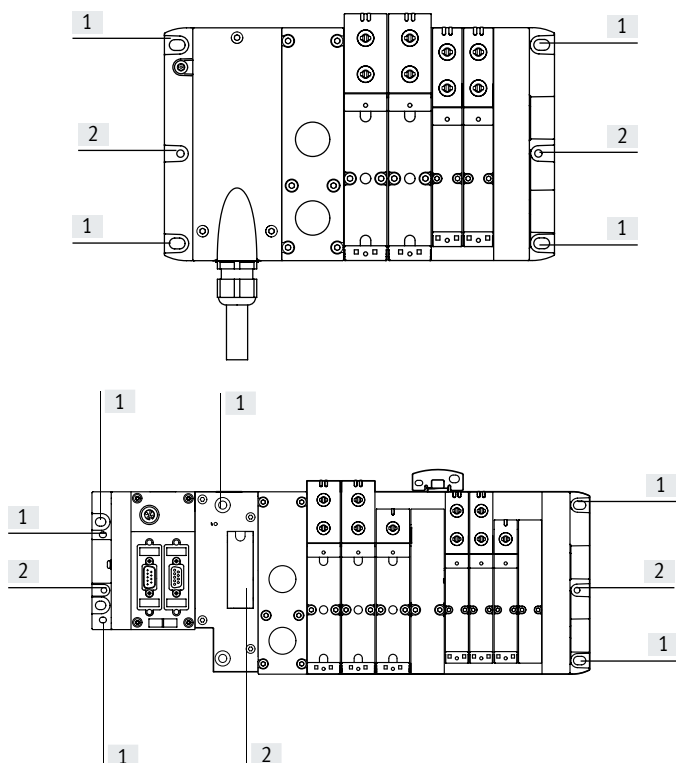

[1] Drilled hole for M6 screw

[2] Drilled hole for H-rail mounting

The valve terminal VTSA/VTSA-F/VTSA-F-CB is screwed onto the mounting surface using M6 screws. The mounting holes are located at the following points:

- Multi-pin plug (4 pieces); 2 each on the multi-pin manifold block and the right end plate
- Fieldbus, CPX (6 pieces); 2 each on the left (CPX) and right (VTSA/VTSA-F) end plate and the pneumatic interface
- I-Port/IO-Link (4 pieces); 2 each on the I-Port/IO-Link interface and on the right end plate

Mounting brackets can be mounted on pneumatic supply plates and manifold sub-bases.

If using CPX components, see:

→ Internet: cpx



Note

Wall mounting of the VTSA/VTSA-F/VTSA-F-CB with more than 5 pneumatic modules

Note the following information to avoid damage to the valve terminal:

- Additionally use mounting brackets of the type VAME-6-W-M46
- Mount these on each fourth plate (manifold sub-base, supply plate or exhaust plate), counting from left to right, starting after the pneumatic interface.
- No mounting bracket is required next to the right end plate.
- Use the pre-assembled mounting brackets when mounting factory pre-assembled valve terminals on a wall.

Key features – Mounting

Wall mounting with CPX polymer interface

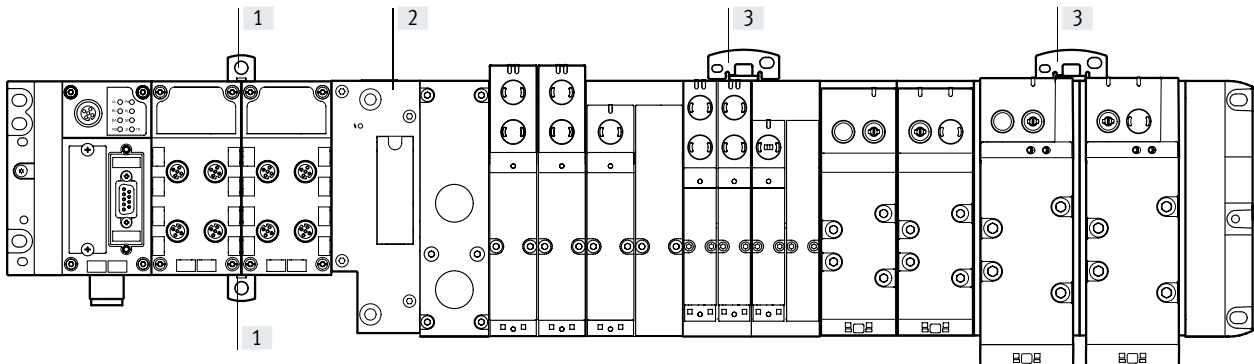

[1] Additional wall mounting for polymer CPX terminal

[2] Pneumatic interface

[3] Additional wall mounting for VTSA/VTSA-F/VTSA-F-CB

(with drilled hole for M5 and M6 screw)

In the case of CPX terminals in polymer design with 4 and more interlinking blocks, additional wall mountings of the type CPX-BG-RW must be used every 100 ... 150 mm. These mountings are clipped in at the top and bottom between the CPX modules.

In the case of the VTSA/VTSA-F/VTSA-F-CB, mounting brackets must be mounted on the wall as indicated above. Brackets of the type VAME-S6-W-M46 must be used as an additional wall mounting.

Key features – Mounting

Wall mounting with CPX metal interface

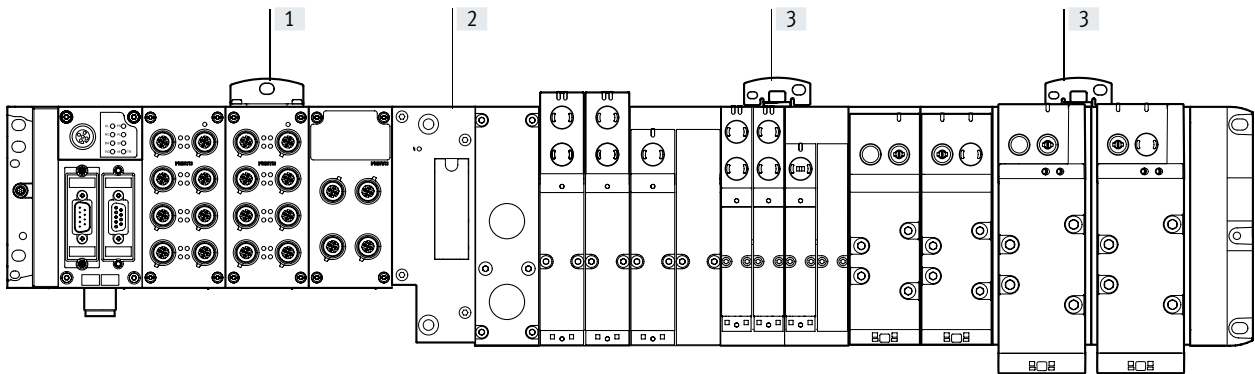

[1] Additional wall mounting for metal CPX terminal

[2] Pneumatic interface

[3] Additional wall mounting for VTSA/VTSA-F/VTSA-F-CB

(with drilled hole for M5 and M6 screw)

In the case of CPX terminals in metal design with 4 and more interlinking blocks, additional wall mountings of the type CPX-M-BG-RW must be used every 100 ... 150 mm. These wall mountings are screwed in at the top of the corresponding CPX module.

In the case of the VTSA/VTSA-F/VTSA-F-CB, mounting brackets must be mounted on the wall as indicated above.

Brackets of the type VAME-S6-W-M46 must be used as an additional wall mounting.

Mounting on support system with CPX metal interface

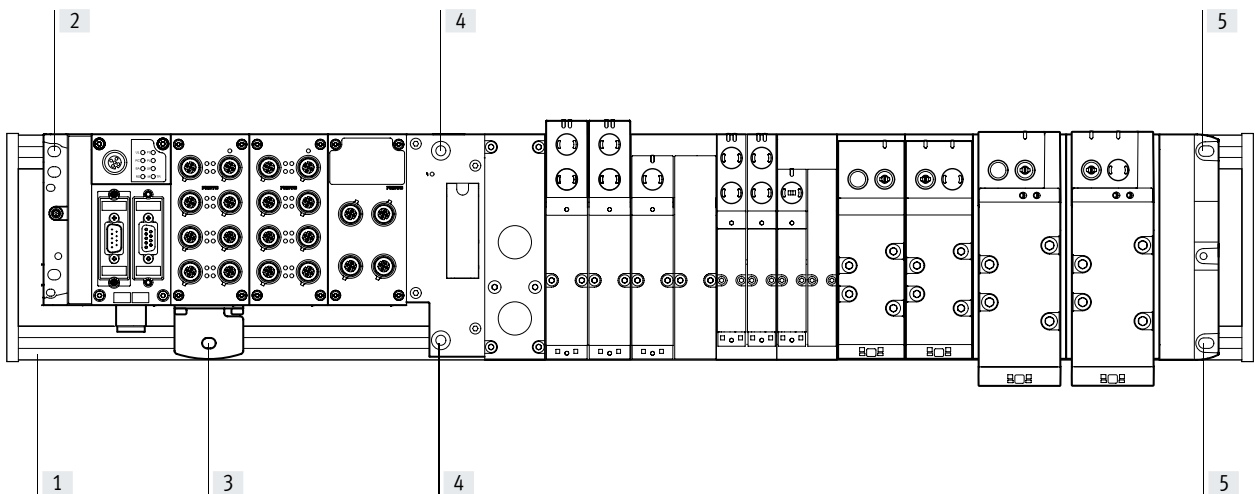

[1] Support system (DIN mounting rail)

[2] Upper mounting for metal CPX terminal, left end plate on DIN mounting rail

[3] Lower mounting for metal CPX terminal on DIN mounting rail with mounting bracket CPX-M-BG-VT-2X

[4] Mounting for pneumatic interface on DIN mounting rail

[5] Mounting for right end plate on DIN mounting rail

If a metal terminal CPX with VTSA pneumatic components is mounted on DIN mounting rails, it may be necessary to have one or more mounting brackets on the CPX side to compensate for the length. It is possible to compensate for the length by using special mounting brackets CPX-M-BG-VT-2X. The mounting bracket connects the metal terminal CPX to the DIN mounting rail.

Note

- Only metal CPX modules with VTSA/VTSA-F/VTSA-F-CB modules of width 18 ... 52 mm must be used.
- The number of mounting brackets required depends on the number of CPX modules installed and whether any system feeds are present.

Further information about mounting the valve terminal can be found in the assembly instructions in the Festo Support Portal

→ Internet: 2D/3D-CAD
→ www.festo.com/sp

Key features – Mounting

H-rail mounting (not permitted for all VTSA-F-CB combinations)

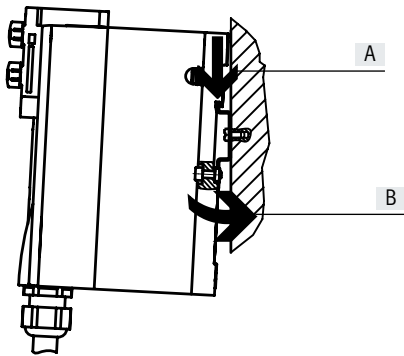

The valve terminal VTSA/VTSA-F/VTSA-F-CB is hooked onto the H-rail (see arrow A).

The valve terminal VTSA/VTSA-F/VTSA-F-CB is then swivelled onto the H-rail and secured in place with the clamping element (see arrow B).

To mount the valve terminal VTSA/VTSA-F/VTSA-F-CB on an H-rail, you will need the mounting kit CPX-CPA-BG-NRH:

This enables the valve terminal to be mounted on an H-rail to EN 60715.

Note

- Wall mounting is recommended if more than one vertical stacking element or a long valve terminal design is required.
- Vibration/shock loads are not permissible with H-rail mounting.
- Only a horizontal mounting position is permissible for H-rail mounting.
- Valve terminals VTSA-F-CB with pneumatic interface with voltage zones cannot be used for H-rail mounting.

Individual valve mounting

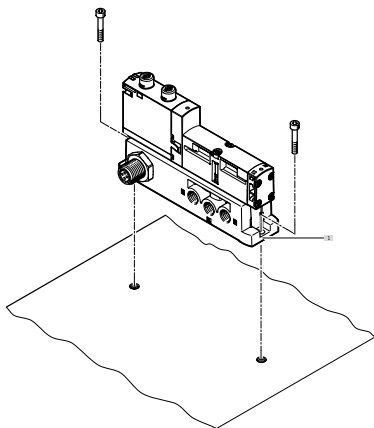

[1] Vertical mounting holes

The individual sub-base for wall mounting is designed for integration into a system or machine. It is mounted vertically.

Key features – Display and operation

Display and operation

Each solenoid coil is allocated an LED which indicates its switching status.

- Indicator 12 shows the switching status of the pilot control for output 2
- Indicator 14 shows the switching status of the pilot control for output 4

Manual override (MO):

The manual override enables the valve to be switched when not electrically actuated or when de-energised. The valve is switched by pushing the manual override. The set switching status can also be locked by turning the manual override.

Alternatives:

- The cover cap (code N) limits the function of the manual override, preventing it from being locked. The valve can then only be actuated as non-detenting.
- The cover cap (code V) can be used to secure the manual override against accidental actuation.
- The heavy-duty cover cap protects the manual override located on the valve. The valve can be actuated as non-detenting or as detenting via accessory.

 **Note**

Special valve variants with pre-assembled cover caps for the manual override are available for valve terminal VTSA/VTSA-F/VTSA-F-CB.

Pneumatic connection and control elements

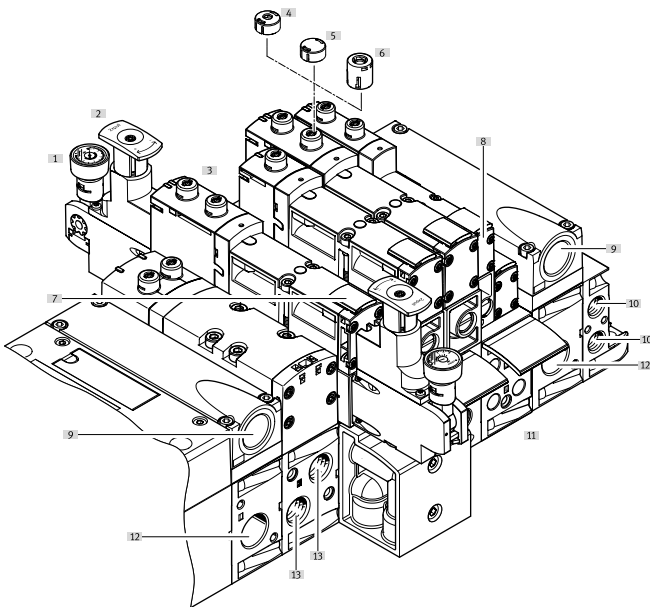

- | | |
|---|---|
| [1] Pressure gauge (optional) | [10] Pilot ports 12 and 14 for supplying the external pilot air |
| [2] Adjusting knob for optional pressure regulator plate | [11] Inscription label holder for sub-base |
| [3] Manual override (MO) (for each pilot solenoid coil, non-detenting or non-detenting/detenting) | [12] Supply port 1 (operating pressure) |
| [4] Cover cap for MO, non-detenting | [13] Working ports 2 and 4, per valve position |
| [5] Cover cap for MO, concealed | |
| [6] Cover cap for MO, non-detenting heavy duty, detenting via accessory | |
| [7] Inscription label holder for valve | |
| [8] Adjusting screw of optional throttle plate | |
| [9] Exhaust ports "Valves" (3/5) | |

 **Note**

A manually operated valve (manual override) cannot be reset electrically. Conversely, an electrically actuated valve cannot be reset using the mechanical manual override.

Key features – Display and operation

Display and operation

Electrical connection and display elements for VTSA/VTSA-F

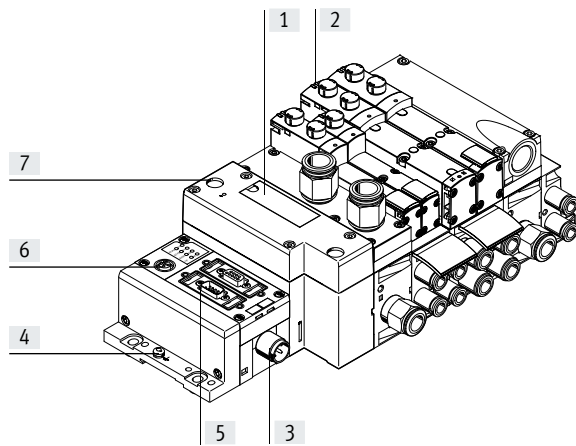

- [1] Inscription area and cover for H-rail mounting
- [2] Yellow LEDs, signal status indication for the pilot solenoid coils
- [3] Power supply connection
- [4] Earthing connection
- [5] Fieldbus interface (bus-specific)
- [6] Service interface for handheld unit, etc.
- [7] Red LED: common error display for valves

Electrical connection and display elements for VTSA-F-CB

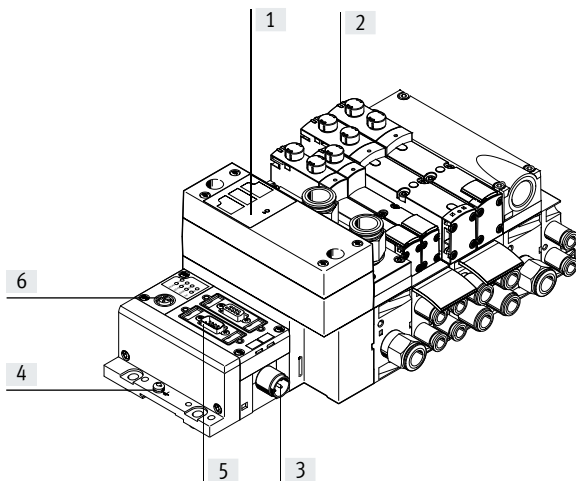

- [1] LED indicators for operating status/diagnostics of the pneumatic interface
- [2] Yellow LEDs, signal status indication for the pilot solenoid coils
- [3] Power supply connection
- [4] Earthing connection
- [5] Fieldbus interface (bus-specific)
- [6] Service interface for handheld unit, etc.

Electrical connection and display elements for AP interface

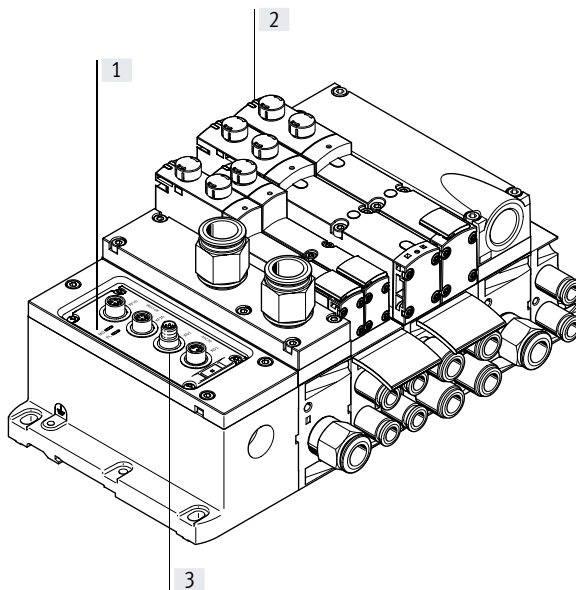

- [1] LED indicators for operating status/diagnostics of the pneumatic interface
- [2] Yellow LEDs: signal status indication for the pilot solenoid coils
- [3] AP interface with connections

Key features – Display and operation

Manual override (MO) – Function

MO with automatic return (non-detenting),

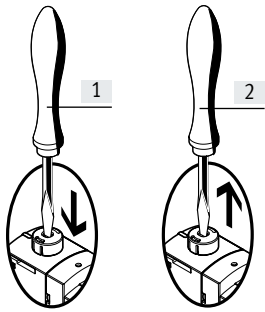

- [1] Press in the plunger of the manual override using a pointed object or screwdriver.
The valve is in the switching position.
- [2] Remove the pointed object or screwdriver.
The spring force pushes the plunger of the manual override back.
The valve returns to its normal position (not with double solenoid valve code J or D).

MO with locking (detenting)

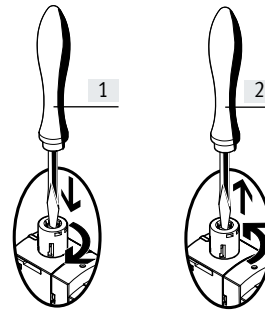

- [1] Press in the plunger of the manual override using a pointed object or screwdriver until the valve switches and then turn the plunger 90° clockwise until the stop is reached.
Valve remains in switching position.
- [2] Turn the plunger 90° anti-clockwise until the stop is reached and then remove the pointed object or screwdriver. The spring force pushes the plunger of the manual override back. The valve returns to its normal position (not with double solenoid valve code J or D).

Cover caps for manual override

Cover cap for MO, heavy-duty, with automatic reset (non-detenting/detenting via accessory)

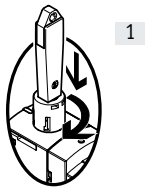

- [1] Non-detenting:
Push in key for MO. The valve is in the switching position.
Detenting:
Turn the coded key in switching position 90° clockwise until the stop is reached. Valve remains in switching position. In this position the key is latched and cannot be removed.

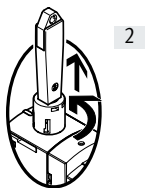

- [2] Turn the key 90° anti-clockwise until the stop is reached. The key is now unlatched. The key is pushed out by the spring force of the manual override. The valve returns to its normal position (not with double solenoid valve code J or D).

Cover cap for MO, with automatic return (non-detenting)

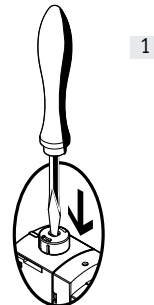

- [1] Restricted function, non-detenting: push in the plunger of the MO cap using a pointed object or screwdriver. The valve is in the switching position.

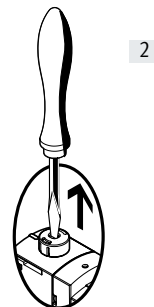

- [2] Remove the pointed object or screwdriver.
The spring force pushes the plunger of the manual override back.
The valve returns to its normal position (not with double solenoid valve code J or D).

Cover cap for MO, concealed

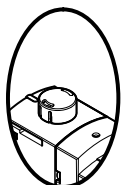





When concealed by the cover cap, the MO can be secured against accidental actuation.

- Note

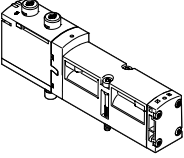
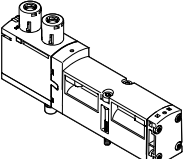
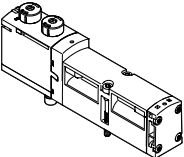
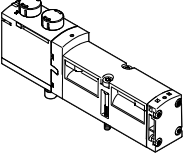
Cover caps for the manual override can be ordered separately as accessories. There are also variants of the VSVA valve with pre-assembled cover caps.

Key features – Display and operation

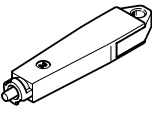
Overview of valve variants and cover caps for manual override (MO)				
Illustration	Terminal code	Description of valve terminal order code	Manual override (MO)	Valve code identification on rating plate sticker ¹⁾
Solenoid valve VSVA without cover cap				
	R	Without cover cap on MO	Non-detenting, detenting	VSVA-B- ... -MZD- ...
Solenoid valve VSVA with pre-assembled cover cap on MO				
	B	MO non-detenting/heavy duty with cover cap, can be used as detenting via accessory (key), as valve variant	Non-detenting, detenting via accessory (key)	VSVA-B- ... -MZTR- ...
	C	MO can only be used as non-detenting with coded cover cap, as valve variant	Non-detenting	VSVA-B- ... -MZH- ...
	D	MO concealed by cover cap – operation of MO prevented, as valve variant	Concealed	VSVA-B- ... -MZ- ...
Cover caps for MO				
	N	MO can only be used as non-detenting with coded cover cap	Non-detenting	VSVA-B- ... -MZD- ...
	V	MO concealed by cover cap – operation of MO prevented	Concealed	VSVA-B- ... -MZD- ...
	A	MO non-detenting/heavy duty with cover cap, detenting via accessory (key)	Non-detenting, detenting via accessory	VSVA-B- ... -MZD- ...
Accessories for manual override, heavy duty				
	–	Coded key (accessory) for actuating the MO, non-detenting/heavy duty, for detenting position	For manual override, detenting	–

1) As an example, the part code for a 5/2-way single solenoid valve, mechanical spring return is used here (e.g.: VSVA-B-M52-MZTR-A2-1T1L)

 **Note**

Cover caps for non-detenting/heavy duty manual override, detenting via accessory, are provided for one-off use only.

If they are used more than once, reliable locking of the cover cap cannot be guaranteed.

Key features – Display and operation, VTSA-F-CB

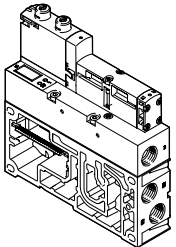
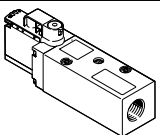
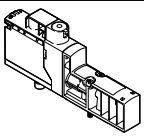
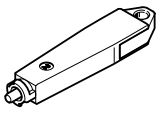
Overview of valve variants and cover caps for manual override (MO) for VTSA-F-CB				
Illustration	Terminal code	Description of valve terminal order code	Manual override (MO)	Valve code identification on the rating plate sticker ¹⁾
Solenoid valve VABF, vacuum generator				
	ZQN	MO can only be used as non-detenting with coded cover cap, as valve variant	Non-detenting	VABF-S4-2-V2B1-G38 ...
	ZQR	Non-detenting MO, can be used as detenting, as valve variant	Non-detenting, detenting without accessories	VABF-S4-2-V2B1-G38 ...
	ZQV	MO concealed by cover cap – operation of MO prevented, as valve variant	Concealed	VABF-S4-2-V2B1-G38 ...
	ZQA	MO non-detenting/heavy duty with cover cap, can be used as detenting via accessory (key), as valve variant	Non-detenting, detenting via accessory (key)	VABF-S4-2-V2B1-G38 ...
Solenoid valve VABF, soft-start valve				
	ZQZ	The manual override can be reset in two ways: <ul style="list-style-type: none"> manually or electrically via control signal 	Detenting, electrically self-resetting	VABF-S6-1-P5A4 ... YE ...
	ZQX	Manual override, concealed	None	VABF-S6-1-P5A4 ... S ...
Solenoid valve VSVA, pilot air switching valve				
	–	The manual override can be reset in two ways: <ul style="list-style-type: none"> manually or electrically via control signal 	Detenting, electrically self-resetting	VSVA-BT-M32CS... YE ...
	ZX	Non-detenting manual override	Non-detenting	VSVA-BT-M32CS... MH ...
	ZZ	Manual override, concealed	None	VSVA-BT-M32CS ... S ...
Accessories for manual override, heavy duty				
	–	Coded key (accessory) for actuating the MO, non-detenting/heavy duty, for detenting position	For manual override, detenting	–

1) As an example, the part code for a 5/2-way single solenoid valve, mechanical spring return is used here (e.g. VSVA-B-M52-MZTR-A2-1T1L)

 **Note**

Cover caps for non-detenting/heavy duty manual override, detenting via accessory, are provided for one-off use only.

If they are used more than once, reliable locking of the cover cap cannot be guaranteed.

Key features – Electric components

Inscription system

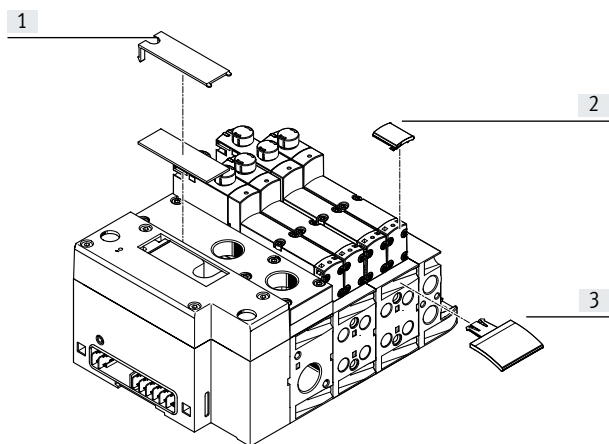

Inscription label holders can be applied to the valves and manifold sub-bases to identify them. These inscription label holders can be ordered by entering the code B or T in the order code for accessories.

Scope of delivery: inscription label holder including inscription label. The following inscription labels can be used as spares:

- Inscription label holder for manifold sub-base type ASCF-M-S6: part no. 540889
 - Inscription label holder for manifold sub-base (for valve width 52 mm) type ASCF-M-S2-2: part no. 562577
- Large inscription labels can be attached to the pneumatic interface as an alternative or in addition to the smaller labels.

- Inscription label holder for valve type ASCF-T-S6: part no. 540888
- Inscription label holder with additional fields for marking valve type ASCF-T-S6-Z: part no. 8106532

- [1] Inscription area (approx. 20 x 45 mm)
- [2] Inscription label holder for valve ASCF-T-S6 (17 x 12.5 mm), ASCF-T-S6-Z
- [3] Inscription label holder for manifold sub-base ASCF-M-S6, ASCF-M-S2-2

Protective circuit

Each solenoid coil VSVA is provided with a spark arresting protective circuit and protected against polarity reversal.

The 24 V DC version of width 52 mm additionally features integrated holding current reduction.

24 V DC version (width 18 to 42 mm)

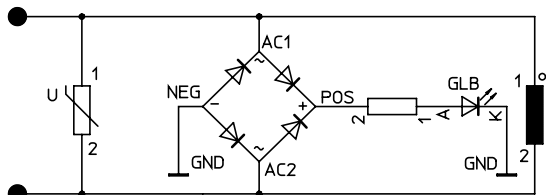

24 V DC version (width 52 mm)

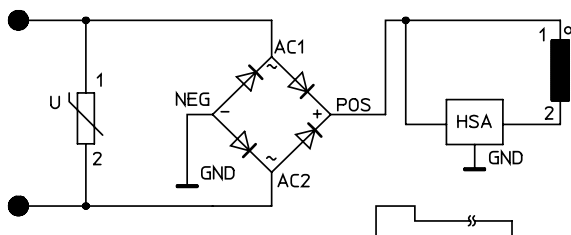

Note

- All control signals of the solenoid coils of a valve terminal share a common load (independent of whether multi-pin, AS-i or CPX).
- With the valve terminal VTSA-F-CB, the common load always refers to a common voltage zone.
- A configuration combining VTSA/VTSA-F and VTSA-F-CB is not permitted.

Key features – Electric components

Individual valve

Valves on individual sub-bases can be used for actuators that are further away from the valve terminal.

- Electrical connection M12, 4-pin 24 V DC
- 4-pin clamped terminal connection for configuration by the user 24 V DC
- Cable (open end) for configuration by the user 24 V DC

Individual electrical connection

A maximum of 20 solenoid coils can be actuated. 2 solenoid coils per valve can be addressed.

Individual electrical connection:

- M12
- 6-way or 10-way
- 5-pin
- 24 V DC

Electrical multi-pin plug connection

The following multi-pin plug connection variants are offered for the valve terminal VTSA/VTSA-F:

- Sub-D multi-pin plug connection (37-pin for 24 V DC): This valve terminal can be equipped with 1 ... 16 valve positions (with double solenoid valves), or with 1 ... 32 valve positions (with single solenoid valves). A maximum of 32 solenoid coils can be actuated.
- Terminal box (terminal strip for 24 V DC): This valve terminal can be equipped with 1 ... 16 valve positions (with double solenoid valves), or with 1 ... 32 valve positions (with single solenoid valves).

A maximum of 32 solenoid coils can be actuated.

- Multi-pin node (round plug): electrical multi-pin plug connection with round plug, 19-pin to CNOMO E03.62.530.N, connecting thread M23 for 24 V DC. The valve terminal can be fitted with max. 16 solenoid coils.

The valves are switched by positive or negative logic (PNP or NPN). Mixed operation is not permissible because all control signals of the solenoid coils of a valve terminal share a common load.

Each pin on the multi-pin plug (Sub-D) or terminal box (terminal strip) can actuate exactly one solenoid coil. When using the maximum configurable number of 32 valve positions, 32 valves can be addressed, each with a single solenoid coil.

With 16 or fewer valve positions, 2 solenoid coils per valve can be addressed.



Note

Use the following 37-pin connecting cables from Festo to connect the valve terminal VTSA/VTSA-F with Sub-D multi-pin plug connection:

- NEBV-...-LE10 for max. 8 solenoid coils
- NEBV-...-LE26 for max. 22 solenoid coils
- NEBV-...-LE27 for max. 23 solenoid coils
- NEBV-...-LE37 for max. 32 solenoid coils
- NECV-S1W37 pre-assembled plug connector

AS-Interface connection

Valve terminals VTSA/VTSA-F with AS-Interface connection can be expanded with up to 8 valves with max. 8 solenoid coils.

The valve terminal with AS-Interface connection is based on the same electrical links as the valve terminal with multi-pin plug connection.

This means a valve terminal with multi-pin plug connection can be converted using an AS-Interface module. The technical specifications of the AS-Interface system must be observed in this case.



Note

AS-i module VAEM-S6-S-FAS-4-4E. Always operate the AS-i module with additional power supply if max. 4 solenoid coils (width 52 mm) are simultaneously supplied with current. More information can be found at:

→ Internet: [as-interface](#)

Fieldbus interface/control block

All functions and features of the electrical peripherals CPX are permitted in connection with the CPX interface. This means that:

- The valves and electrical outputs are supplied via the operating voltage connection CPX
- The valves are supplied and switched off independently via a separate port on the CPX



Note

More information can be found at:

→ Internet: [cpx](#)

Key features – Electric components

I-Port/IO-Link

Valve terminals VTSA/VTSA-F with I-Port/IO-Link connection can be expanded with up to 16 valves with max. 32 solenoid coils.

The valve terminal with I-Port/IO-Link connection is based on the same electrical interlinking as the valve terminal with multi-pin plug connection.

This means a valve terminal with multi-pin plug connection can be converted using an I-Port/IO-Link module. The technical specifications of the I-Port/IO-Link system must be observed in this case.



Note

AS-i module VAEM-S6-S-FAS-4-4E. Always operate the AS-i module with additional power supply if max. 4 solenoid coils (width 52 mm) are simultaneously supplied with current.

More information can be found at:

→ Internet: i-port, io-link

AP interface

VTSA/VTSA-F valve terminals with AP interface can be expanded with up to 12 valves with a maximum of 24 solenoid coils.

The valve terminal with AP interface is based on the same electrical linkage as the valve terminal with multi-pin plug connection.

This means a valve terminal with multi-pin plug connection can be converted using an AP interface. The technical specifications of the AP interface must be observed in this case.



Note

AS-i module VAEM-S6-S-FAS-4-4E. Always operate the AS-i module with additional power supply if max. 4 solenoid coils (width 52 mm) are simultaneously supplied with current.

More information can be found at:

→ Internet: ap

Key features – Electric components

Rules for addressing

Address allocation

Address allocation doesn't depend on whether single or double solenoid valves are fitted.

Addresses are assigned in ascending order without gaps, from left to right.

Single solenoid valve

A valve position for actuating one solenoid coil (VABV...T1) occupies one address.

Double solenoid valve

A valve position for actuating two solenoid coils (VABV...T2) occupies two addresses. The following assignment applies in this case:

- Coil 14: lower-value address
- Coil 12: higher-value address

Connecting cable

The wire colours refer to the following pre-assembled connecting cables from Festo:

- NEBV-...-LE10 for valve terminal with max. 8 solenoid coils
- NEBV-...-LE26 for valve terminal with max. 22 solenoid coils
- NEBV-...-LE27 for valve terminal with max. 23 solenoid coils
- NEBV-...-LE37 for valve terminal with max. 32 solenoid coils

Pin allocation – Multi-pin plug, Sub-D socket, 24 V DC, electrical control code MP1

	Pin ²⁾	Address/coil	Wire colour ¹⁾		Pin ²⁾	Address/coil	Wire colour ¹⁾
	1	0	WH		17	16	WH PK
	2	1	BN		18	17	PK BN
	3	2	GN		19	18	WH BU
	4	3	YE		20	19	BN BU
	5	4	GY		21	20	WH RD
	6	5	PK		22	21	BN RD
	7	6	BU		23	22	GY GN
	8	7	RD		24	23	YE GY
	9	8	GY PK		25	24	PK GN
	10	9	RD BU		26	25	YE PK
	11	10	WH GN		27	26	GN BU
	12	11	BN GN		28	27	YE BU
	13	12	WH YE		29	28	GN RD
	14	13	YE BN		30	29	YE RD
	15	14	WH GY		31	30	GN BK
	16	15	GY BN		32	31	GY BU
<p>Note The drawing shows a plan view of the Sub-D plug socket at the connecting cable NEBV-...</p>	Conductor						
	33	0 V ³⁾	YE BK		35	0 V ³⁾	BN BK
	34	0 V ³⁾	WH BK		36	0 V ³⁾	BK
	Earthing						
	37	FE	VT		-	-	-

1) To IEC 757

2) Pin 9 ... 35: not allocated in the case of connecting cable NEBV-...-LE10

Pin 23 ... 33: not allocated in the case of connecting cable NEBV-...-LE26

Pin 24 ... 33: not allocated in the case of connecting cable NEBV-...-LE27

3) Connect 0 V for positive-switching control signals, 24 V for negative-switching control signals. Mixed operation is not permissible because all control signals of the solenoid coils of a valve terminal share a common load!

Key features – Electric components

Dimensions

Download CAD data → www.festo.com

Connecting cable NEBV...

[1] Cable connector M20x1.5

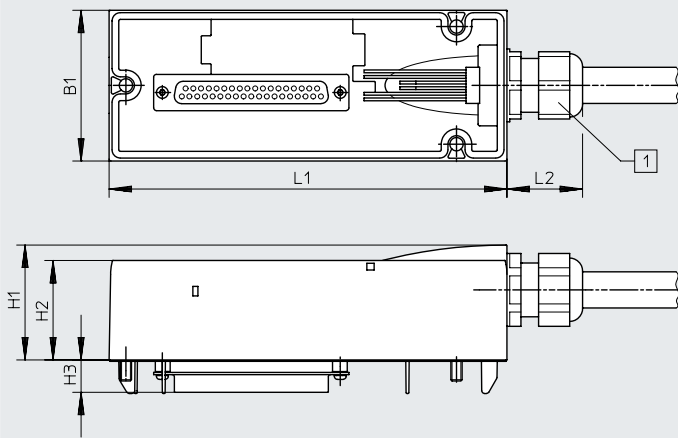

Type	B1	H1	H2	H3	L1	L2
NEBV...	54	41	36	11.6	142	27

Ordering data – Connecting cable, Sub-D, 24 V DC, electrical control code MP1

	Cable sheath	Connecting cable	Length [m]	Part no.	Type
	TPE-U(PUR)	For max. 8 solenoid coils, 10-core	2.5	539240	NEBV-S1W37-E-2.5-LE10
			5	539241	NEBV-S1W37-E-5-LE10
			10	539242	NEBV-S1W37-E-10-LE10
		For max. 22 solenoid coils, 26-core	2.5	539243	NEBV-S1W37-E-2.5-LE26
			5	539244	NEBV-S1W37-E-5-LE26
			10	539245	NEBV-S1W37-E-10-LE26
		For max. 32 solenoid coils, 37-core	2.5	539246	NEBV-S1W37-K-2.5-LE37
			5	539247	NEBV-S1W37-K-5-LE37
			10	539248	NEBV-S1W37-K-10-LE37
	PVC	For max. 8 solenoid coils, 10-core	2.5	543271	NEBV-S1W37-KM-2.5-LE10
			5	543272	NEBV-S1W37-KM-5-LE10
			10	543273	NEBV-S1W37-KM-10-LE10
		For max. 23 solenoid coils, 27-core	2.5	543274	NEBV-S1W37-KM-2.5-LE27
			5	543275	NEBV-S1W37-KM-5-LE27
			10	543276	NEBV-S1W37-KM-10-LE27
For max. 32 solenoid coils, 37-core		2.5	543277	NEBV-S1W37-KM-2.5-LE37	
		5	543278	NEBV-S1W37-KM-5-LE37	
		10	543279	NEBV-S1W37-KM-10-LE37	

Key features – Electric components

Pin allocation – Multi-pin, terminal strip (Cage Clamp), 24 V DC; electrical control code T (based on standard: EN 61984)

Each solenoid coil is assigned to a specific terminal on the terminal strip in order for the valves to be actuated.

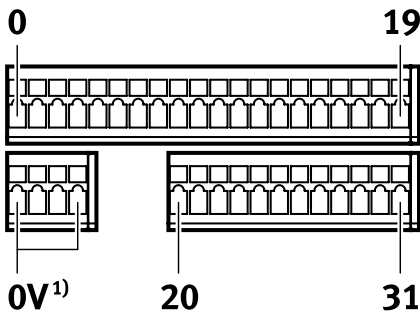

Terminal	Coil/address	Terminal	Coil/address
1	0	17	16
2	1	18	17
3	2	19	18
4	3	20	19
5	4	21	20
6	5	22	21
7	6	23	22
8	7	24	23
9	8	25	24
10	9	26	25
11	10	27	26
12	11	28	27
13	12	29	28
14	13	30	29
15	14	31	30
16	15	32	31

Note
The drawing shows a plan view of the multi-pin terminal strip (Cage Clamp).

Conductor		Conductor	
33	0 V	35	0 V
34	0 V	36	0 V

Pin allocation – Multi-pin, round plug, 24 V DC; electrical control code MP4

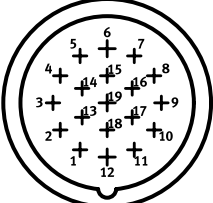

Address	Pin ¹⁾	Address	Pin ¹⁾
0	15	8	17
1	7	9	9
2	5	10	2
3	4	11	13
4	16	12	11
5	8	13	10
6	3	14	1
7	14	15	18

Pin allocation – Multi-pin plug, round plug, 24 V DC; electrical actuation – CNOMO allocation

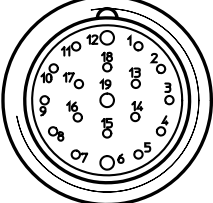

Pin	Valve position/solenoid coil	Pin	Valve position/solenoid coil
1	8/14	10	7/12
2	6/14	11	7/14
3	4/14	12	FE
4	2/12	13	6/12
5	2/14	14	4/12
6	0 V ¹⁾	15	1/14
7	1/12	16	3/14
8	3/12	17	5/14
9	5/12	18	8/12
		19	Not assigned

1) Pin 6: 0 V for positive-switching control signals; connect 24 V for negative-switching control signals; mixed operation is not permitted!
 Pin 12: earth
 Pin 19: not allocated

Key features – Electric components

Electrical connection, individual valve with connector plug 24 V DC up to width 52 mm

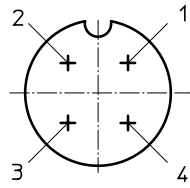
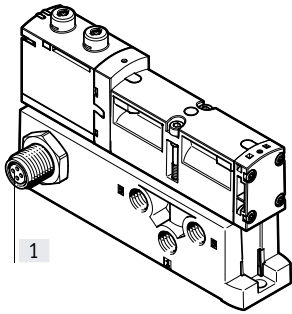

[1] 1xM12 plug, 4-pin to EN 61076-2-101

Pin allocation M12 on individual valve to ISO 20401

With positive logic:

- Pin1 – Not allocated
- Pin2 – U_B for coil 12
- Pin3 – 0 V for coil 12 and 14
- Pin4 – U_B for coil 14

With negative logic:

- Pin1 – Not allocated
- Pin2 – 0 V for coil 12
- Pin3 – U_B for coil 12 and 14
- Pin4 – 0 V for coil 14

Electrical connection, individual valve 24 V DC up to width 52 mm

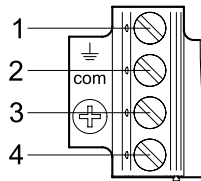
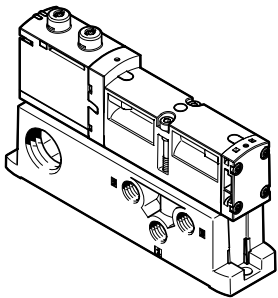

Pin allocation for assembly by the user

With positive logic:

- Pin1 – Not allocated
- Pin2 – U_B for coil 12
- Pin3 – 0 V for coil 12 and 14
- Pin4 – U_B for coil 14

With negative logic:

- Pin1 – Not allocated
- Pin2 – 0 V for coil 12
- Pin3 – U_B for coil 12 and 14
- Pin4 – 0 V for coil 14

Individual electrical connection, 6-way or 10-way, 24 V DC, code MP2/MP3 for valve terminal up to width 52 mm

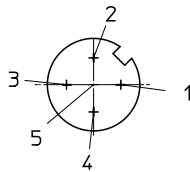
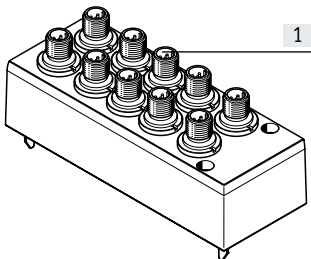

[1] 1xM12 plug, 5-pin

Pin allocation M12

With positive logic:

- Pin1 – Not allocated
- Pin2 – U_B for coil 12
- Pin3 – 0 V for coil 12 and 14
- Pin4 – U_B for coil 14
- Pin5 – Functional earth

Pin allocation M12

With negative logic:

- Pin1 – Not allocated
- Pin2 – 0 V for coil 12
- Pin3 – U_B for coil 12 and 14
- Pin4 – 0 V for coil 14
- Pin5 – Functional earth

Note

- Mixed operation of positive-switching (PNP) and negative-switching (NPN) control signals is not permissible because all control signals of the solenoid coils of a valve terminal share a common load.
- All M12 connections (MP2/MP3) within a valve terminal share a common load.

Instructions for use

Operating materials

Operate your system with unlubricated compressed air, if possible. Festo valves and cylinders are designed so that, if used as intended, they will not require additional lubrication and will still achieve a long service life.

The quality of compressed air downstream of the compressor must correspond to that of unlubricated compressed air. If possible, do not operate the entire system with lubricated compressed air. The lubricators should, where possible, always be installed directly upstream of the actuator requiring them.

Incorrect additional oil and too high an oil content in the compressed air reduce the service life of the valve terminal.

Use Festo special oil OFSW-32 or the alternatives listed in the Festo catalogue (as specified in DIN 51524 HLP32; basic oil viscosity 32 CST at 40°C).

Bio-oils

When using bio-oils (oils which are based on synthetic or native esters, e.g. rapeseed oil methyl ester), the maximum residual oil content of 0.1 mg/m³ must not be exceeded (see ISO 8573-1:2010 Class 2).

Mineral oils

When using mineral oils (e.g. HLP oils to DIN 51524, parts 1 to 3) or similar oils based on poly-alpha-olefins (PAO), the maximum residual oil content of 5 mg/m³ must not be exceeded (see ISO 8573-1:2010 Class 4). A higher residual oil content is not permitted, regardless of the compressor oil, because permanent lubrication would otherwise be flushed out over a period of time.

Datasheet – AP interface

Control signals from the controller to the valve terminal are transmitted via the AP bus protocol from Festo.

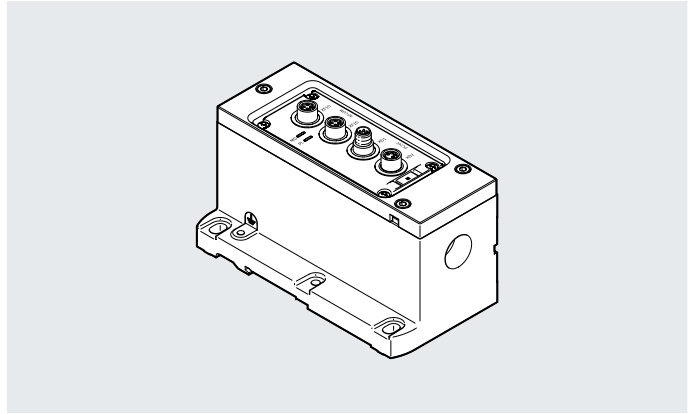

Application

The AP interface connects the VTSA valve terminal with up to 12 valves (24 valve coils) to a CPX-AP system.

Implementation

The AP interface is used for direct integration of the VTSA valve terminal into the decentralised IO system.

General technical data

AP interface	
Connection position	On top
Reverse polarity protection	Yes
Number of pins/wires	4
Maximum number of valve positions	12
Max. no. of solenoid coils	24

Datasheet – AP interface

General data		
Diagnostics via LED		Diagnostics per module
		Power supply load
Diagnostics via internal communication		Switch-off load supply
		Electronics/sensors overvoltage
		Load undervoltage
Module parameters		Configuration of voltage monitoring load supply PL
		Response in error state
Technical data – Electrics		
Nominal operating voltage	[V AC]	110
	[V DC]	24
Nominal operating voltage for electrics/sensors	[V DC]	24
Nominal operating voltage, load	[V DC]	24
Permissible voltage fluctuations, electrics/sensors	[%]	± 25
Permissible voltage fluctuations, load	[%]	± 10
Intrinsic current consumption of electrics/sensors	[mA]	typ. 34 mA
Intrinsic current consumption of load	[mA]	typ. 16 mA
Max. power supply	[A]	2 x 4 A (external fuse required)
Power failure buffering	[ms]	10
Mains buffering of load	[ms]	3
Fuse protection (short circuit)		Internal electronic fuse per channel
Power supply		
Function		Incoming electronics/sensors and load
Connection type		Plug
Connection technology		M8x1, A-coded
Number of pins/wires		4
Voltage transmission		
Function		Outgoing electronics/sensors and load
Connection type		Socket
Connection technology		M8x1, A-coded
Number of pins/wires		4
Technical data – Mechanical components		
Product weight	[g]	712
Dimensions W x L x H	[mm]	71 x 142 x 84
Materials		
Cover		Die-cast aluminium
Threaded sleeve		Nickel-plated brass
Note on materials		RoHS-compliant
LABS (PWIS) conformity		VDMA24364-B2-L

Datasheet – AP interface

Operating and environmental conditions		
Ambient temperature	[°C]	+5 ... +50
Note on ambient temperature		Note ambient temperature derating according to IEC 61131-2:2017
Storage temperature	[°C]	-20 ... +60
Relative humidity	[%]	5 ... 95
		Non-condensing
Corrosion resistance class CRC ¹⁾		2
CE marking (see declaration of conformity) ²⁾		To EU EMC Directive
		To EU RoHS Directive
Certification		RCM
Degree of protection		IP65
Note on degree of protection		In mounted state
		Seal unused connections
Nominal operating altitude	[m]	≤ 2000 m above sea level
Maximum cable length	[m]	50, system communication
Maximum setup altitude	[m]	3500
Note on the maximum setup altitude		> 2000 m ASL (< 79.5 kPa)
		Note ambient temperature derating according to IEC 61131-2:2017

1) Corrosion resistance class CRC 2 to Festo standard FN 940070

Moderate corrosion stress. Indoor applications in which condensation can occur. External visible parts with primarily decorative surface requirements that are in direct contact with a normal industrial environment.

2) More information: www.festo.com/catalogue/... → Support/Downloads.

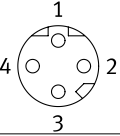
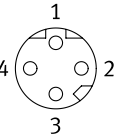
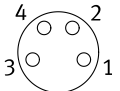
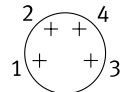
Pin assignment			
	Pin	Allocation	Description
M8, D-coded, socket			
AP in (AP-COM) 	1	TX-	AP bus, transmission signal positive
	2	RX+	AP bus, receive signal positive
	3	TX+	AP bus, receive signal negative
	4	RX-	AP bus, transmission signal negative
AP out (AP-COM) 	1	RX-	AP bus, transmission signal positive
	2	TX+	AP bus, receive signal positive
	3	RX+	AP bus, receive signal negative
	4	TX-	AP bus, transmission signal negative
Power out (voltage transmission) 	1	24 V PS	Supply voltage for electronics and sensors
	2	0 V PL	Supply voltage for valves and outputs
	3	0 V PS	Supply voltage for electronics and sensors
	4	24 V PL	Supply voltage for valves and outputs
M8, D-coded, plug			
Power In (power supply) 	1	24 V PS	Supply voltage for electronics and sensors
	2	0 V PL	Supply voltage for valves and outputs
	3	0 V PS	Supply voltage for electronics and sensors
	4	24 V PL	Supply voltage for valves and outputs

Datasheet – AP interface

Connection and display components

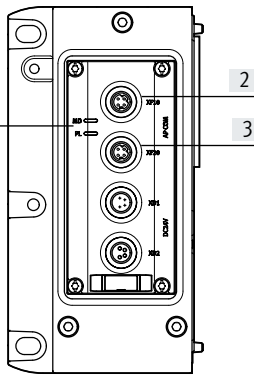

[1] LED displays for module diagnostics (MD) and power load (PL)
 [2] AP in (AP-COM)
 [3] AP out (AP-COM)
 [4] Power in (power supply)
 [5] Power out (voltage transmission)

Dimensions

Download CAD data → www.festo.com

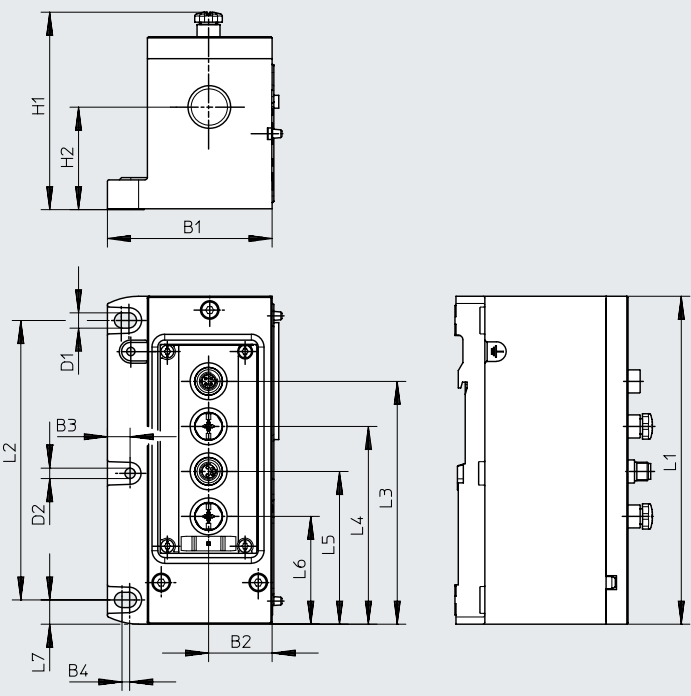

Type	B1	B2	B3	B4	D1	D2	H1	H2
VABA-S6-1-AP	71.3	27.5	9.8	3	6.6	4.5	85.5	44.4

Type	L1	L2	L3	L4	L5	L6	L7
VABA-S6-1-AP	142	121	105.2	85.7	66.2	46.7	10.5

Ordering data – AP interface

	Description	Part no.	Type
	AP interface for operation in an AP system	8152356	VABA-S6-1-AP

Datasheet – Valve terminal

-  Valve width to ISO 15407-2
 - 18 mm
 - 26 mm
- to ISO 5599-2
 - 42 mm (ISO 1)
 - 52 mm (ISO 2)

-  Flow rate¹⁾
 - Width 18 mm: up to 550 (700) l/min
 - Width 26 mm: up to 1100 (1350) l/min
 - Width 42 mm: up to 1300 (1860) l/min
 - Width 52 mm up to 2900 l/min

-  Voltage 24 V DC

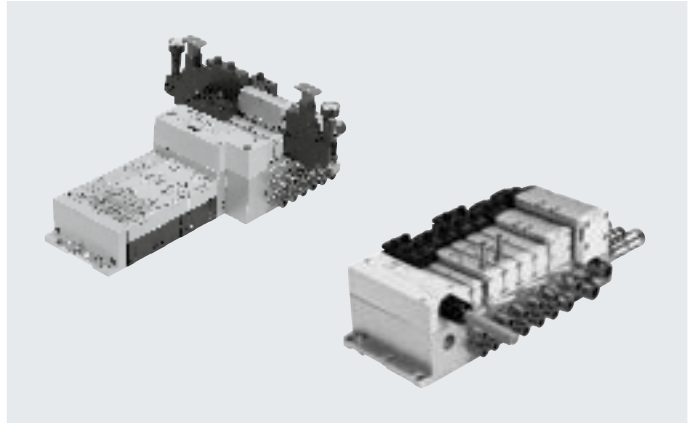

1) Flow rates in brackets apply to VTSA-F

General technical data for VTSA/VTSA-F

Terminal type VTSA/VTSA-F	VTSA is the standard version, VTSA-F is the version with optimised flow rate
Valve sizes	Widths 18 mm, 26 mm, 42 mm, 52 mm
Actuation type	Electrical
Electrical actuation	With multi-pin plug: multi-pin, IO-Link With fieldbus: integrated controller, fieldbus, Industrial Ethernet
Pilot air supply	Internal/external
Exhaust function, can be throttled	Via throttle plate
Type of mounting	Wall mounting On H-rail to EN 60715
Mounting position	Any
Signal status display	LED
Manual override	Detenting, non-detenting, concealed
Suitable for vacuum	Yes
Valve terminal design	Modular, valve sizes can be mixed
Max. no. of valve positions	32 ¹⁾

Pneumatic connections – Threaded connection

Pneumatic connection	Via manifold sub-base	
Supply port	1	Dependent on the end plate or supply plate used (and adapter plate when using ISO size 3 valves)
Exhaust port	3/5	Dependent on the end plate or supply plate used (and adapter plate when using ISO size 3 valves)
Working ports	2/4	Dependent on the connection type selected
External pilot air supply port	14	Dependent on the end plate used (and adapter plate when using ISO size 3 valves)
Pilot exhaust air port	12	Dependent on the end plate used (and adapter plate when using ISO size 3 valves)

1) Dependent on the electrical interface and the manifold sub-bases used

† Note: this product conforms to ISO 1179-1 and ISO 228-1.

Datasheet – Valve terminal VTSA-F-CB

-  Valve width
- 18 mm (ISO 02)
 - 26 mm (ISO 01)
 - 42 mm (ISO 1)
- to ISO 5599-2
- 52 mm (ISO 2)

-  Voltage
- 24 V DC

-  Flow rate¹⁾
- Width 18 mm:
up to 700 l/min
- Width 26 mm:
up to 1350 l/min
- Width 42 mm:
up to 1860 l/min
- Width 52 mm:
up to 2900 l/min



1) Flow rates apply to 5/2-way solenoid valve

General technical data for VTSA-F-CB					
Terminal type CPX/VTSA-F-CB	Type 46				
Design	Piston spool valve				
Valve functions	<ul style="list-style-type: none"> • 5/2-way solenoid valve • 5/3-way solenoid valve¹⁾ • 2x 3/2-way solenoid valve • 2x 2/2-way solenoid valve Integration of vacuum generation, soft-start/quick exhaust valve, switchable pilot air				
Valve sizes, width [mm]	18	26	42	52	
Grid dimension [mm]	38	54	43	59	
Number of valves/plates	2	2	1	1	
To standard	–	–	–	Standardised	
Actuation type	Electrical				
Electrical actuation	Fieldbus: CPX				
Pilot air supply	Internal/external				
Exhaust function, can be throttled	Via throttle plate				
Type of mounting	Wall mounting				
	On H-rail to EN 60715 (not possible in combination with CPX-FVDA-P2 (safety module))				
Mounting position	Any				
Signal status display	LED				
Manual override	Non-detenting/detenting; non-detenting/concealed; non-detenting-heavy duty/detenting with accessories; self-resetting via electrical control signal				
Suitable for vacuum	Yes				
Valve terminal design	Modular, valve sizes can be mixed				
Note on forced checking procedure	Switching frequency min. 1/month				
Max. no. of valve positions	Max. 24 per voltage zone: max. 4 x 24 = 96				
Number of voltage zones	≤ 6				
Pneumatic connection	Via manifold sub-base				
Supply port 1	Via right end plate (G1/2 and G3/4) or supply plate or soft-start valve				
Exhaust port 3/5	Via right end plate (G1/2 and G3/4) or supply plate or soft-start valve				
Pilot air port 12	Either ducted				
Working ports 2/4	G1/8	G1/4	G3/8	G1/2	
Tubing size: small [mm]	6	8	10	12	
Tubing size: large [mm]	8	10	12	16	
Fittings	QS fittings, tubing dimensions metric or imperial (hybrid)				

1) If neither solenoid coil is energised, the valve is moved to its mid-position by spring force. If both solenoid coils are energised at the same time, the valve remains in the previously assumed switching position

Datasheet – Valve terminal

Standard nominal flow rate of valve/valve terminal [l/min]									
Valve function (with valve code)	Terminal code	Width 18 mm				Width 26 mm			
		Valve	Valve on valve terminal			Valve	Valve on valve terminal		
			VTSA	VTSA-F	VTSA-F-CB		VTSA	VTSA-F	VTSA-F-CB
5/2-way, double solenoid (B52)	J	750	550	700	700	1400	1100	1350	1350
5/2-way, double solenoid with dominant signal (D52)	D	750	550	700	700	1400	1100	1350	1350
5/2-way, single solenoid, pneumatic spring (M52-A)	M	750	550	700	700	1400	1100	1350	1350
5/2-way, single solenoid, mechanical spring (M52-M)	O	750	550	700	700	1400	1100	1350	1350
5/3-way, closed (P53C)	G	700	450	650	650	1400 ¹⁾ 700 ²⁾	1000 ¹⁾ 700 ²⁾	1350 ¹⁾ 700 ²⁾	1350 ¹⁾ 700 ²⁾
5/3-way, exhausted (P53E)	E	700 ¹⁾ 330 ²⁾	450 ¹⁾ 330 ²⁾	480 ¹⁾ 330 ²⁾	480 ¹⁾ 330 ²⁾	1400 ¹⁾ 700 ²⁾	1000 ¹⁾ 700 ²⁾	1350 ¹⁾ 700 ²⁾	1350 ¹⁾ 700 ²⁾
5/3-way, pressurised (P53U)	B	700 ¹⁾ 330 ²⁾	450 ¹⁾ 330 ²⁾	480 ¹⁾ 330 ²⁾	480 ¹⁾ 330 ²⁾	1400 ¹⁾ 700 ²⁾	1000 ¹⁾ 700 ²⁾	1350 ¹⁾ 700 ²⁾	1350 ¹⁾ 700 ²⁾
5/3-way, exhausted, switching position 14 detenting (P53ED) ³⁾	SA	–	380 ¹⁾ 310 ²⁾	430 ¹⁾ 360 ²⁾	430 ¹⁾ 360 ²⁾	1400 ¹⁾ 700 ²⁾	1000 ¹⁾ 700 ²⁾	1350 ¹⁾ 700 ²⁾	1350 ¹⁾ 700 ²⁾
5/3-way, exhausted, switching position 12 detenting (P53EP) ³⁾	SE	–	380 ¹⁾ 300 ²⁾	460 ¹⁾ 350 ²⁾	460 ¹⁾ 350 ²⁾	1400 ¹⁾ 700 ²⁾	1000 ¹⁾ 700 ²⁾	1350 ¹⁾ 700 ²⁾	1350 ¹⁾ 700 ²⁾
5/3-way, port 2 pressurised, 4 exhausted, switching position 14 detenting (P53AD) ³⁾	SB	–	380 ¹⁾ 350 ²⁾	440 ¹⁾ 400 ²⁾	440 ¹⁾ 400 ²⁾	700 ¹⁾ 700 ²⁾	700 ¹⁾ 700 ²⁾	700 ¹⁾ 700 ²⁾	700 ¹⁾ 700 ²⁾
5/3-way, port 4 pressurised, 2 exhausted, switching position 14 detenting (P53BD) ³⁾	SD	–	370 ¹⁾ 340 ²⁾	430 ¹⁾ 360 ²⁾	430 ¹⁾ 360 ²⁾	–	850 ¹⁾ 820 ²⁾	950 ¹⁾ 860 ²⁾	950 ¹⁾ 860 ²⁾
2x3/2-way, single solenoid, closed (T32C)	K	600	400	550	550	1250	900	1150	1150
2x3/2-way, single solenoid, open (T32U)	N	600	400	550	550	1250	900	1150	1150
2x3/2-way, single solenoid, open/closed (T32H)	H	600	400	550	550	1250	900	1150	1150
2x3/2-way, single solenoid, closed (T32N)	Q	600	400	550	550	1250	900	1150	1150
2x3/2-way, single solenoid, open (T32F)	P	600	400	550	550	1250	900	1150	1150
2x3/2-way, single solenoid, open/closed (T32W)	R	600	400	550	550	1250	900	1150	1150
2x2/2-way, single solenoid, closed (T22C)	VC	700	500	650	650	1350	1000	1300	1300
2x2/2-way, single solenoid, closed (T22CV)	VV	700	500	650	650	1350	1000	1300	1300

1) Switching position
 2) Mid-position
 3) The valve functions P53ED, P53EP, P53AD and P53BD are only available in the 24 V DC version. Values only apply to 24 V DC.

Datasheet – Valve terminal

Standard nominal flow rate of valve/valve terminal [l/min]									
Valve function (with valve code)	Terminal code	Width 42 mm				Width 52 mm			
		Valve	Valve on valve terminal			Valve	Valve on valve terminal		
			VTSA	VTSA-F	VTSA-F-CB		VTSA	VTSA-F	VTSA-F-CB
5/2-way, double solenoid (B52)	J	2000	1300	1860	1860	4000	2900	2900	2900
5/2-way, double solenoid with dominant signal (D52)	D	2000	1300	1860	1860	4000	2900	2900	2900
5/2-way, single solenoid, pneumatic spring (M52-A)	M	2000	1300	1860	1860	4000	2900	2900	2900
5/2-way, single solenoid, mechanical spring (M52-M)	O	2000	1300	1860	1860	4000	2900	2900	2900
5/3-way, closed (P53C)	G	1900 ¹⁾ 950 ²⁾	1200 ¹⁾ 800 ²⁾	1690 ¹⁾ 830 ²⁾	1690 ¹⁾ 830 ²⁾	3600 ¹⁾ 1700 ²⁾	2800 ¹⁾ 1700 ²⁾	2800 ¹⁾ 1700 ²⁾	2800 ¹⁾ 1700 ²⁾
5/3-way, exhausted (P53E)	E	1900 ¹⁾ 950 ²⁾	1200 ¹⁾ 800 ²⁾	1690 ¹⁾ 830 ²⁾	1690 ¹⁾ 830 ²⁾	3600 ¹⁾ 1700 ²⁾	2800 ¹⁾ 1700 ²⁾	2800 ¹⁾ 1700 ²⁾	2800 ¹⁾ 1700 ²⁾
5/3-way, pressurised (P53U)	B	1900 ¹⁾ 950 ²⁾	1200 ¹⁾ 800 ²⁾	1690 ¹⁾ 830 ²⁾	1690 ¹⁾ 830 ²⁾	3600 ¹⁾ 1700 ²⁾	2800 ¹⁾ 1700 ²⁾	2800 ¹⁾ 1700 ²⁾	2800 ¹⁾ 1700 ²⁾
5/3-way, pressurised 1 to 2, 4 to 5 closed (P53F) ³⁾	VG	1700 ¹⁾ 700 ²⁾	1400 ¹⁾ 800 ²⁾	1700 ¹⁾ 700 ²⁾	1700 ¹⁾ 700 ²⁾	3000 ¹⁾ 900 ²⁾	2300 ¹⁾ 900 ²⁾	2300 ¹⁾ 900 ²⁾	2300 ¹⁾ 900 ²⁾
2x3/2-way, single solenoid, closed (T32C)	K	1600	1200	1300	1300	3000	2400	2400	2400
2x3/2-way, single solenoid, open (T32U)	N	1600	1200	1300	1300	3000	2400	2400	2400
2x3/2-way, single solenoid, open/closed (T32H)	H	1600	1200	1300	1300	3000	2400	2400	2400
2x3/2-way, single solenoid, closed (T32N)	Q	1600	1200	1300	1300	3000	2400	2400	2400
2x3/2-way, single solenoid, open (T32F)	P	1600	1200	1300	1300	3000	2400	2400	2400
2x3/2-way, single solenoid, open/closed (T32W)	R	1600	1200	1300	1300	3000	2400	2400	2400
2x2/2-way, single solenoid, closed (T22C)	VC	1600	1400	1500	1500	4000	2800	2800	2800
2x2/2-way, single solenoid, closed (T22CV)	VV	1600	1400	1500	1500	–	–	–	–

1) Switching position

2) Mid-position

3) The valve function P53F is only available in the 24 V DC version. Values only apply to 24 V DC.

Datasheet – Valve terminal

Flow rate q_n as a function of output pressure p_2 with pressure regulator plates (P regulator plate) for port 1

6 bar

10 bar

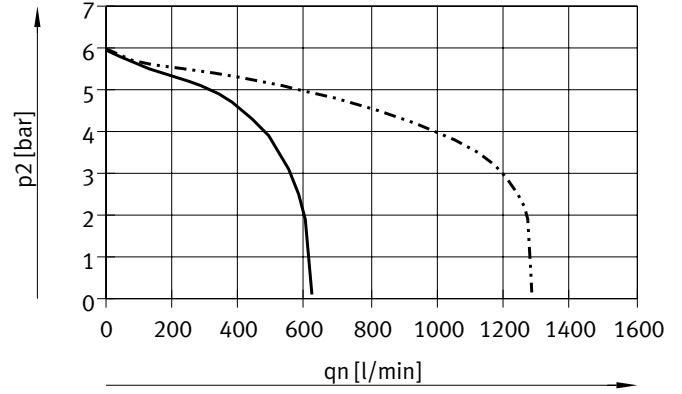
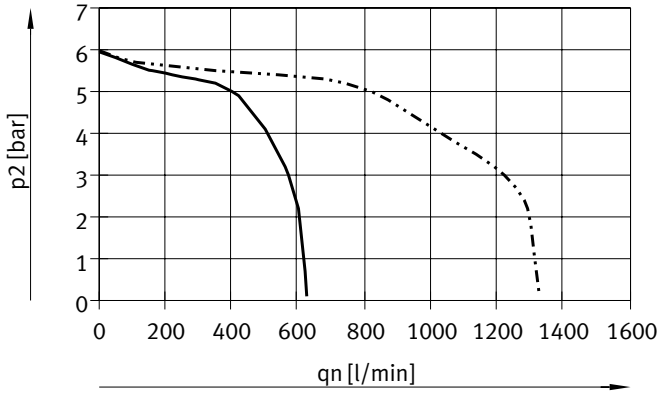

— Width 18 mm
- - - - - Width 26 mm

— Width 18 mm
- - - - - Width 26 mm

Input pressure 10 bar, set regulated pressure 6 bar

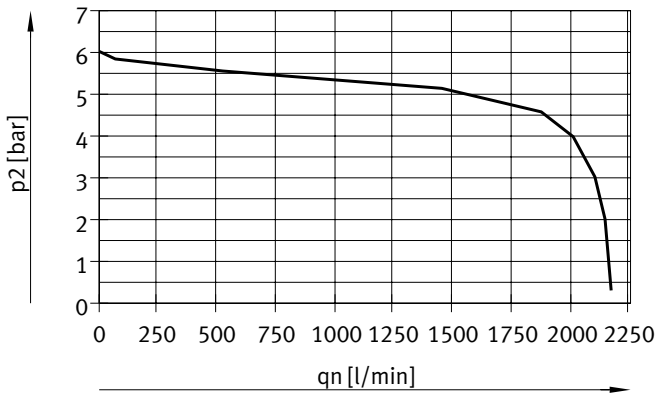

Width 42 mm (ISO 1)

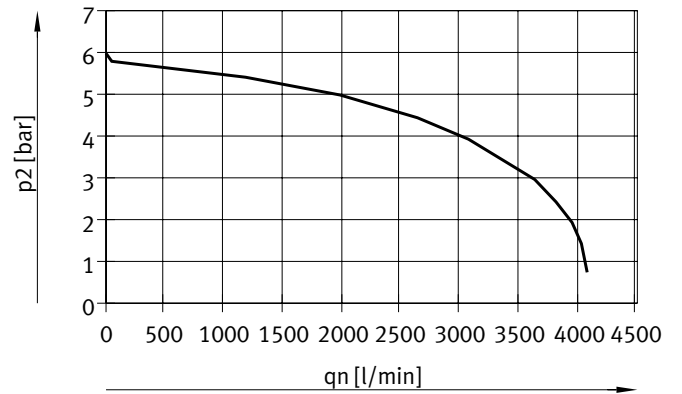

Width 52 mm (ISO 2)

Datasheet – Valve terminal

Flow rate q_n as a function of output pressure p_2 with pressure regulator plates (AB regulator plates) for port 2, 4 or ports 4/2
 6 bar 10 bar

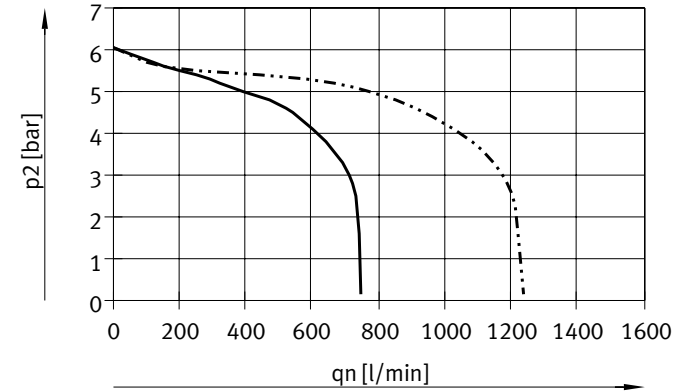

— Width 18 mm
 - - - - - Width 26 mm

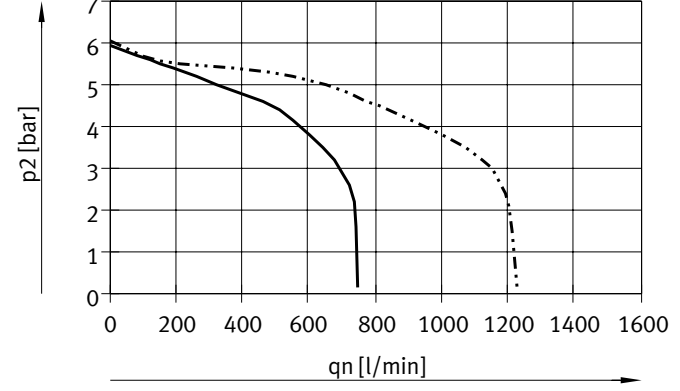

— Width 18 mm
 - - - - - Width 26 mm

Input pressure 10 bar, set regulated pressure 6 bar

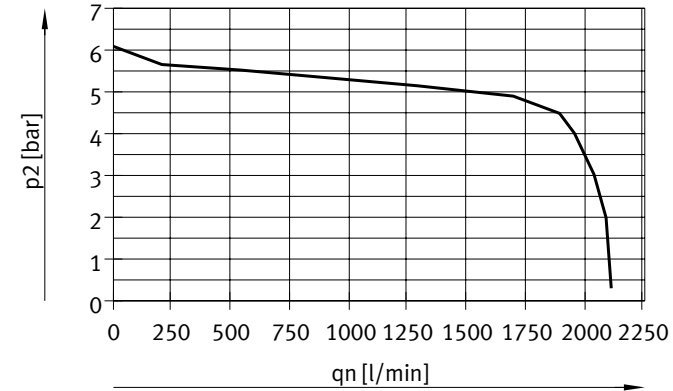

Width 42 mm (ISO 1)

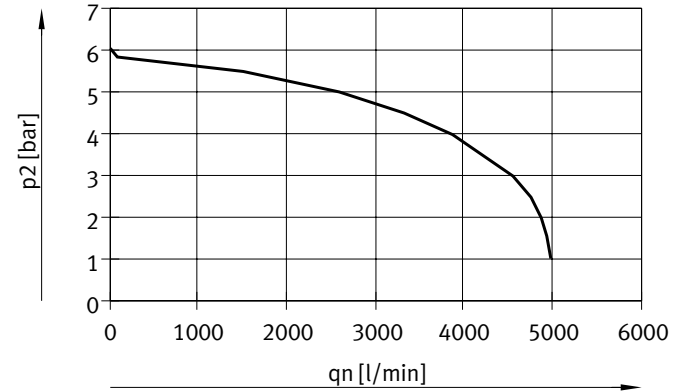

Width 52 mm (ISO 2)

Datasheet – Valve terminal

Flow rate q_n as a function of output pressure p_2 with pressure regulator plates (AB regulator plates, rev.) for ports 4/2, reversible

6 bar

10 bar

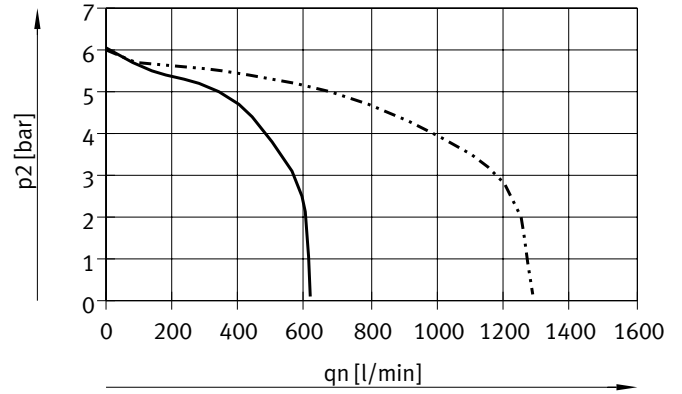
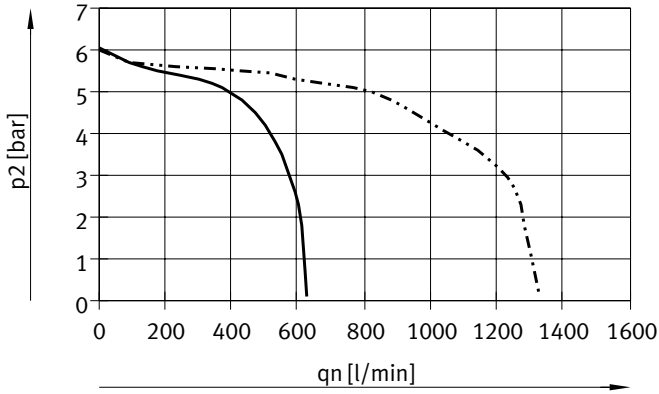

— Width 18 mm
- - - Width 26 mm

— Width 18 mm
- - - Width 26 mm

Input pressure 10 bar, set regulated pressure 6 bar

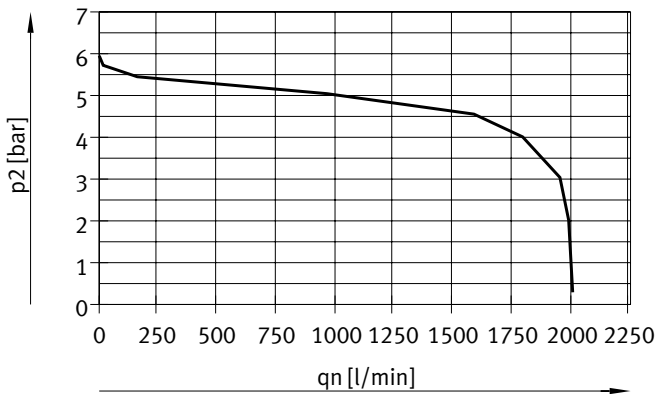

Width 42 mm (ISO 1)

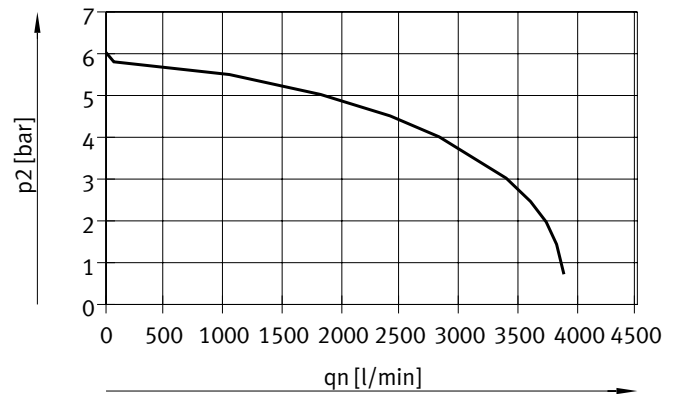

Width 52 mm (ISO 2)

Datasheet – Valve terminal

Flow rate q_N as a function of flow control

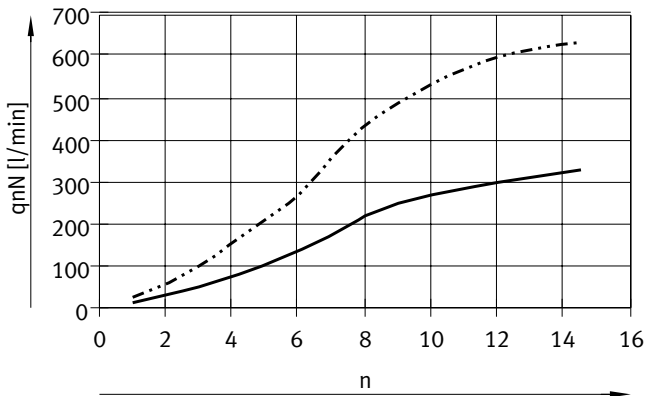

— Width 18 mm
 - · - · - Width 26 mm

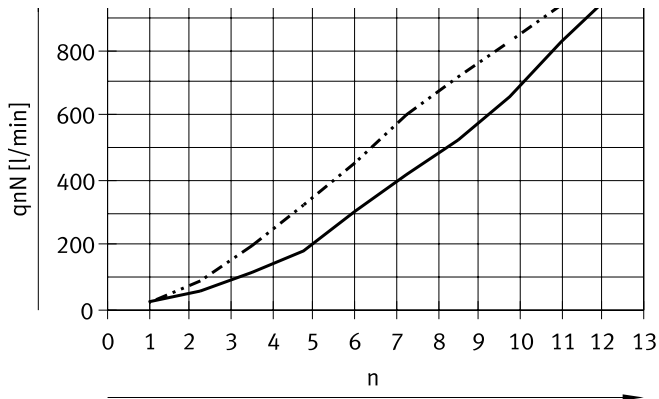

Width 42 mm (ISO 1)
 — Flow control screw from 2 → 3
 - · - · - Flow control screw from 4 → 5
 n = revolutions of the adjusting screw

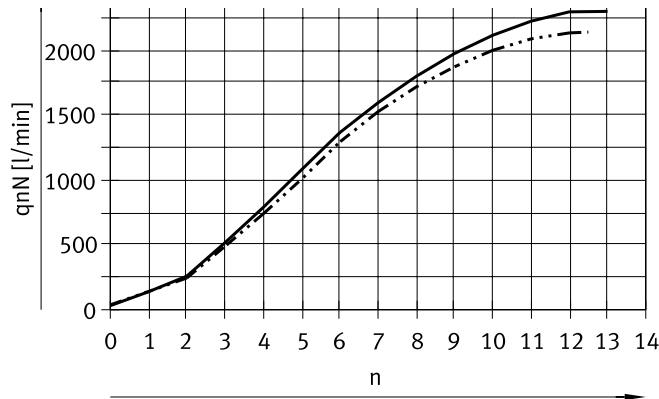

Width 52 mm (ISO 2)
 — Flow control screw from 2 → 3
 - · - · - Flow control screw from 4 → 5
 n = revolutions of the adjusting screw

Datasheet – Valve terminal

Pilot pressure p12/14 as a function of operating pressure p1

For 3/2-way solenoid valves (T32, T22)

For 5/2-way solenoid valves (M52, B52, D52, P53)

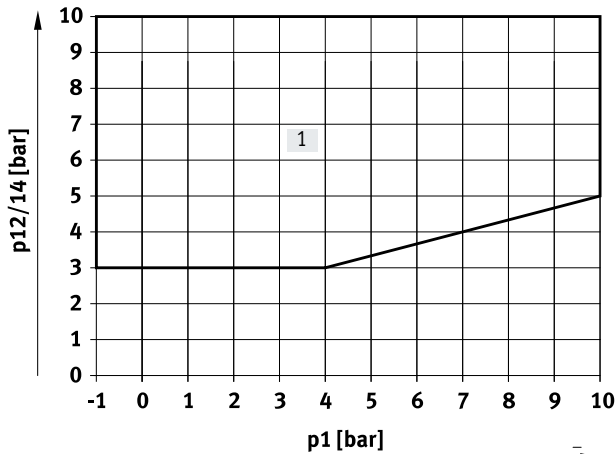

[1] Operating range for valves with external pilot air supply

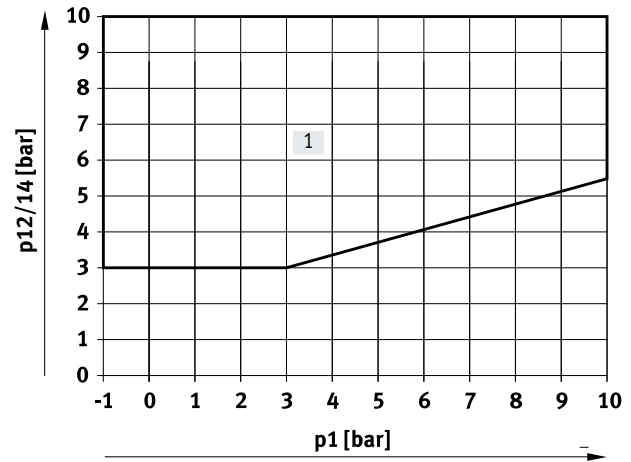

[1] Operating range for valves with external pilot air supply

Standard nominal flow rate with vertical stacking [l/min]

Widths	18 mm	26 mm	42 mm	52 mm
Throttle plate				
VABF-S4-2-F1B1-C	See characteristic curve	–	–	–
VABF-S4-1-F1B1-C	–	See characteristic curve	–	–
VABF-S2-1-F1B1-C	–	–	1100	–
VABF-S2-2-F1B1-C	–	–	–	See characteristic curve
Vertical supply plate				
VABF-S4-2-P1A ... -G18	430	–	–	–
VABF-S4-1-P1A ... -G14	–	900	–	–
VABF-S2-1-P1A ... -G38	–	–	1300	–
VABF-S2-2-P1A ... -G12	–	–	–	2800
Vertical pressure shut-off plate				
VABF-S4-2-L1D1-C	400	–	–	–
VABF-S4-2-L1D2-C ¹⁾	320	–	–	–
VABF-S4-1-L1D1-C	–	800	–	–
VABF-S4-1-L1D2-C ¹⁾	–	620	–	–
VABF-S2-1-L1D1-C	–	–	1200	–
VABF-S2-2-L1D1-C	–	–	–	1950

1) Lockable with key

Datasheet – Valve terminal

Operating and environmental conditions		
Type	VTSA/VTSA-F	VTSA-F-CB
Operating medium	Compressed air to ISO 8573-1:2010 [7:4:4]	Compressed air to ISO 8573-1:2010 [7:4:4]
Pilot medium	Compressed air to ISO 8573-1:2010 [7:4:4]	Compressed air to ISO 8573-1:2010 [7:4:4]
Notes on operating/ pilot medium	Lubricated operation possible (in which case lubricated operation will always be required)	Lubricated operation not possible
External	[bar]	-0.9 ... +10
	[MPa]	-0.09 ... +1
Internal	[bar]	3 ... 10
	[MPa]	0.3 ... 1
Pilot pressure	[bar]	3 ... 10
	[MPa]	0.3 ... 1
Noise level LpA	[dB(A)]	85
Ambient temperature	[°C]	-5 ... +50
Temperature of medium	[°C]	-5 ... +50
Storage temperature	[°C]	-20 ... +60
Relative humidity	[%]	0 ... 90
Certification	BIA	-
	C-Tick	-
	c UL us – Recognized (OL)	-
CE marking (see declaration of conformity)	To EU Low Voltage Directive (only for VTSA-MP)	-
	To EU EMC Directive ¹⁾	To EU EMC Directive ¹⁾
	To EU Explosion Protection Directive (ATEX, EX1E ³⁾)	-
KC marking	KC EMC	KC EMC
ATEX category for gas	II 3G (EX1E ³⁾)	-
Type of (ignition) protection for gas	Ex ec IIC T3 Gc X (EX1E ³⁾)	-
Explosion ambient temperature	[°C]	-5 ... +50 (EX1E ³⁾)
Corrosion resistance class CRC ⁴⁾		0
Corrosion resistance class CRC for IO-Link ⁵⁾		2

1) For information about the area of use, see the EC declaration of conformity at: www.festo.com/catalogue/... → Support/Downloads.

If the devices are subject to usage restrictions in residential, commercial or light-industrial environments, further measures for the reduction of the emitted interference may be necessary.

2) Solenoid valves with code VC (2/2-way type ... T22C), N (3/2-way type ... T32U), K (3/2-way type ... T32C), H (3/2-way type ... T32H) must not be operated with vacuum; the operating pressure here is 3 ... 10 bar

3) Certification is valid for VTSA/VTSA-F-MP, VTSA/VTSA-F-FB

4) Corrosion resistance class CRC 0 to Festo standard FN 940070

No corrosion stress. Applies to small, visually unimportant standards-based parts such as threaded pins, circlips and clamping sleeves which are usually only available on the market in a phosphated or burnished version (and possibly oiled) as well as to ball bearings (for components < CRC 3) and plain bearings.

5) Corrosion resistance class CRC 2 to Festo standard FN 940070

Moderate corrosion stress. Indoor application where condensation may occur. External visible parts with primarily decorative surface requirements that are in direct contact with the surrounding industrial environment.

Datasheet – Valve terminal

Electrical data – Individual electrical connection**Load voltage supply for valves (U_{val})**

Operating voltage	[V DC]	24 ±10%
Max. total current at 24 V DC	[A]	10
Duty cycle		100%
Degree of protection		IP65, NEMA 4 (for all types of signal transmission when mounted)

Electrical data – Multi-pin plug connection**Load voltage supply for valves (U_{val})**

Operating voltage	[V DC]	24 ±10%
Max. total current	[A]	6
Acceptable current load at 40°C	[A]	1
Surge resistance	[kV]	1.5
Pollution degree		3
Duty cycle		100%
Degree of protection		IP65, NEMA 4 (for all types of signal transmission when mounted)

Electrical data – With CPX terminal**Power supply for electronics ($U_{EL/SEN}$)**

Operating voltage	[V DC]	24 ±10%
Max. intrinsic current consumption at 24 V DC	[mA]	20
Duty cycle		100%

Load voltage supply for valves (U_{val})

Operating voltage	[V DC]	24 ±10%
Diagnostic message undervoltage U_{OFF} load voltage outside the functional range	[V]	21.6 ... 21.5
Degree of protection		IP65, NEMA 4 (for all types of signal transmission when mounted)

Materials

Manifold sub-base	Die-cast aluminium
Valve	Die-cast aluminium, PA
Seals	FPM, NBR, HNBR
Supply plate, supply plate cover	Die-cast aluminium
Right end plate	Die-cast aluminium
Pneumatic interface for CPX	Die-cast aluminium
Throttle plate	Die-cast aluminium
Pressure regulator plate	Die-cast aluminium, PA
Multi-pin manifold block	Die-cast aluminium
Cover for the pneumatic interface and multi-pin plug connection	PA
Note on materials	RoHS-compliant
LABS (PWIS) conformity (only for IO-Link)	VDMA24364-B2-L

Datasheet – Valve terminal

Product weight	Width				
	Approx. weights [g]	18 mm	26 mm	42 mm	52 mm
Multi-pin node with Sub-D or terminal strip for VTSA/VTSA-F ¹⁾	550				
Multi-pin node with M12 individual connection for VTSA/VTSA-F	760				
Pneumatic interface CPX for VTSA/VTSA-F	590				
• With diagnostics for undervoltage of valves (VABA-S6-1-X1/X2/X2-D)					
Pneumatic interface CPX for VTSA-F-CB	580				
• With 3x load supplies (VABA-S6-1-X1/X2-3V-CB)					
• For PROFIsafe, with diagnostics for undervoltage, short circuit of valves, wire break per solenoid coil (VABA-S6-1-X2-F1/F2-CB)	734				
• With diagnostics for undervoltage, short circuit of valves, wire break per solenoid coil (VABA-S6-1-X1/X2-CB)	560				
IO-Link interface	690				
Electrical interface for AS-Interface for VTSA/VTSA-F	300				
AS-Interface module for VTSA/VTSA-F	850				
Supply plate for valve terminal VTSA/VTSA-F ²⁾					
• Exhaust plate with 3 and 5 common	617				
• Exhaust air cover with 3 and 5 separate	597				
Supply plate/extension module for VTSA-F-CB ²⁾					
• Exhaust plate with 3 and 5 common	611				
• Exhaust air cover with 3 and 5 separate	600				
Right end plate ³⁾					
• With threaded connections	339				336
• Selector switch	281				–
Manifold sub-base for VTSA/VTSA-F ⁴⁾	447	634	340, 330 ⁵⁾		610
Manifold sub-base for VTSA-F-CB ⁴⁾	434	579	330		610
90°-connection plate ³⁾	170	230	176		359
Pressure regulator plate					
• For port 1 (P)	350	402	640		1190
• For port 4 or 2 (A or B)	367	448	640		1230
• For ports 4 and 2 (A/B)	611	692	920		1990
Throttle plate	228	320	220		565
Vertical supply plate ³⁾	140	191	340		605
Vertical pressure shut-off plate	209	273	600		1030
Vertical pressure shut-off plate (lockable with key)	231	290	–		–
Valves → Solenoid valves, widths					
Cover plate	34	73	68		146

1) With sheet metal seal, printed circuit board

2) With sheet metal seal and electrical link

3) With screws

4) With sheet metal seal, electrical link, inscription label holder, 4 screws

5) Manifold sub-base optimised for flow rate, HS

Datasheet – Valve terminal

Dimensions

Download CAD data → www.festo.com

Valve terminal with individual electrical connection

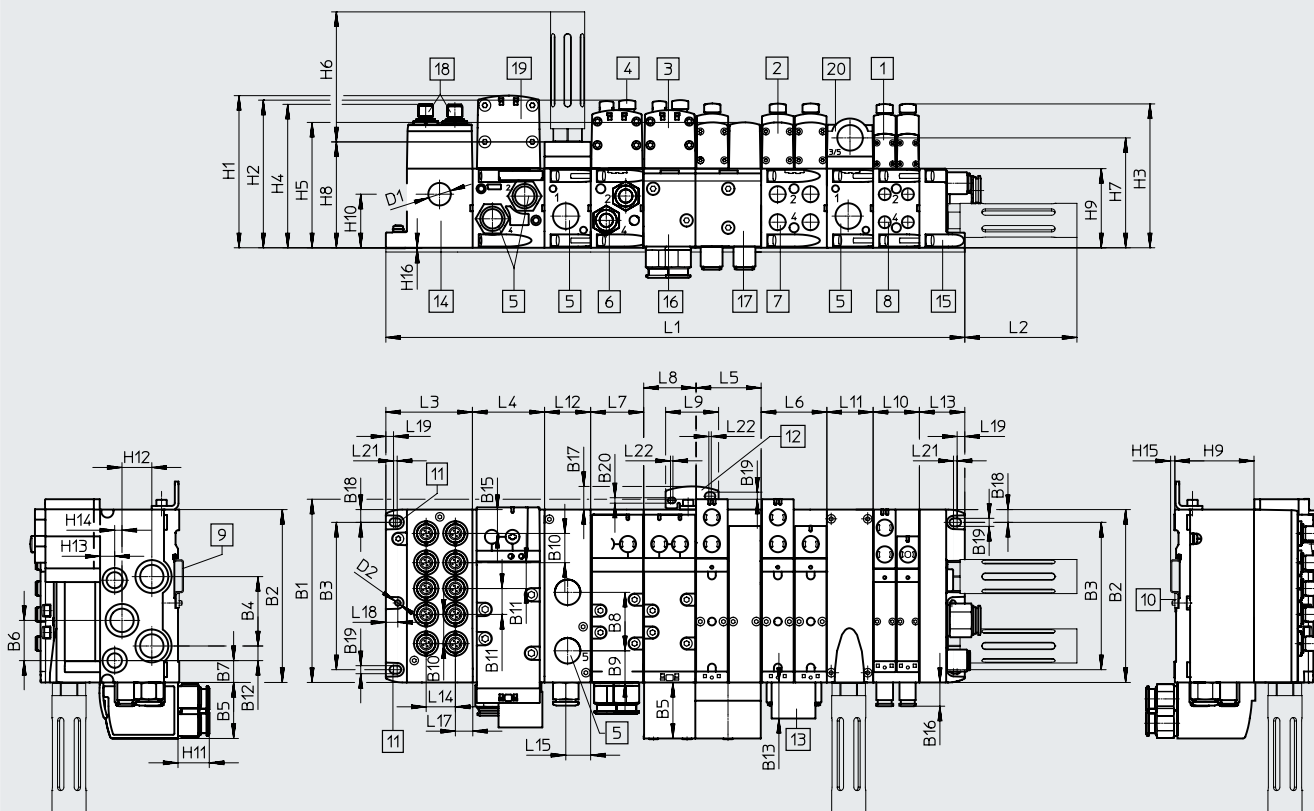

- | | | | |
|--------------------------------|----------------------------------|---------------------------------------|---|
| [1] Solenoid valve width 18 mm | [7] Threaded connection G1/4 | [16] 90°-connection plate 43 mm, G3/8 | n02 Number of manifold sub-bases 38 mm |
| [2] Solenoid valve width 26 mm | [8] Threaded connection G1/8 | [17] 90°-connection plate 54 mm, G1/4 | n01 Number of manifold sub-bases 54 mm |
| [3] Solenoid valve width 42 mm | [9] H-rail | [18] M12 plug 5-pin (6-way or 10-way) | n1 Number of manifold sub-bases 43 mm |
| [4] Cover cap/manual override | [10] H-rail mounting | [19] Solenoid valve width 52 mm | n2 Number of manifold sub-bases 59 mm |
| [5] Threaded connection G1/2 | [11] Mounting hole | [20] Supply plate | n Number of supply plates (only with end plate with pilot air selector) |
| [6] Threaded connection G3/8 | [12] Additional mounting bracket | | |
| | [13] Inscription label holder | | |
| | [14] Individual connection | | |
| | [15] End plate | | |

Dim.	B1	B2	B3	B4	B5	B6	B7	B8	B9	B10	B11	B12	B13	B14	B15	B16	B17	B18	B19	B20
[mm]	150.5	142	121	57	46	33	18	48	26	24	21.3	12	29.6	23	19.6	19.5	19	10.5	6.6	4.5

Dim.	L2	L3	L4	L5	L6	L7	L8	L9	L10	L11	L12	L13	L14	L15	L16	L17	L18	L19
[mm]	92.4	71.3	n2x59	n01x54	54	n1x43	43	43.5	n02x38	nx38	38	37.3	24	20.5	20	14.1	9.8	6.3

Dim.	L20	L21	L22	D1∅	D2∅	H1	H2	H3	H4	H5	H6	H7	H8	H9	H10	H11	H12	H13	H14	H15	H16
[mm]	5.5	3	2	18.5	4.5	125	121.3	118.2	118	103	107.8	90.3	87	65	44	25.7	24.5	12	6	3.5	0.5

Width	L1
18 mm	71.3 + n02 x 38 + n x 38 + 37.3
26 mm	71.3 + n01 x 54 + n x 38 + 37.3
42 mm	71.3 + n1 x 43 + n x 38 + 37.3
52 mm	71.3 + n2 x 59 + n x 38 + 37.3
Mixture of 18 mm, 26 mm, 42 mm and 52 mm	71.3 + n02 x 38 + n01 x 54 + n1 x 43 + n2 x 59 + n x 38 + 37.3

† Note: this product conforms to ISO 1179-1 and ISO 228-1.

Datasheet – Valve terminal

Dimensions

Download CAD data → www.festo.com

Valve terminal with multi-pin plug connection

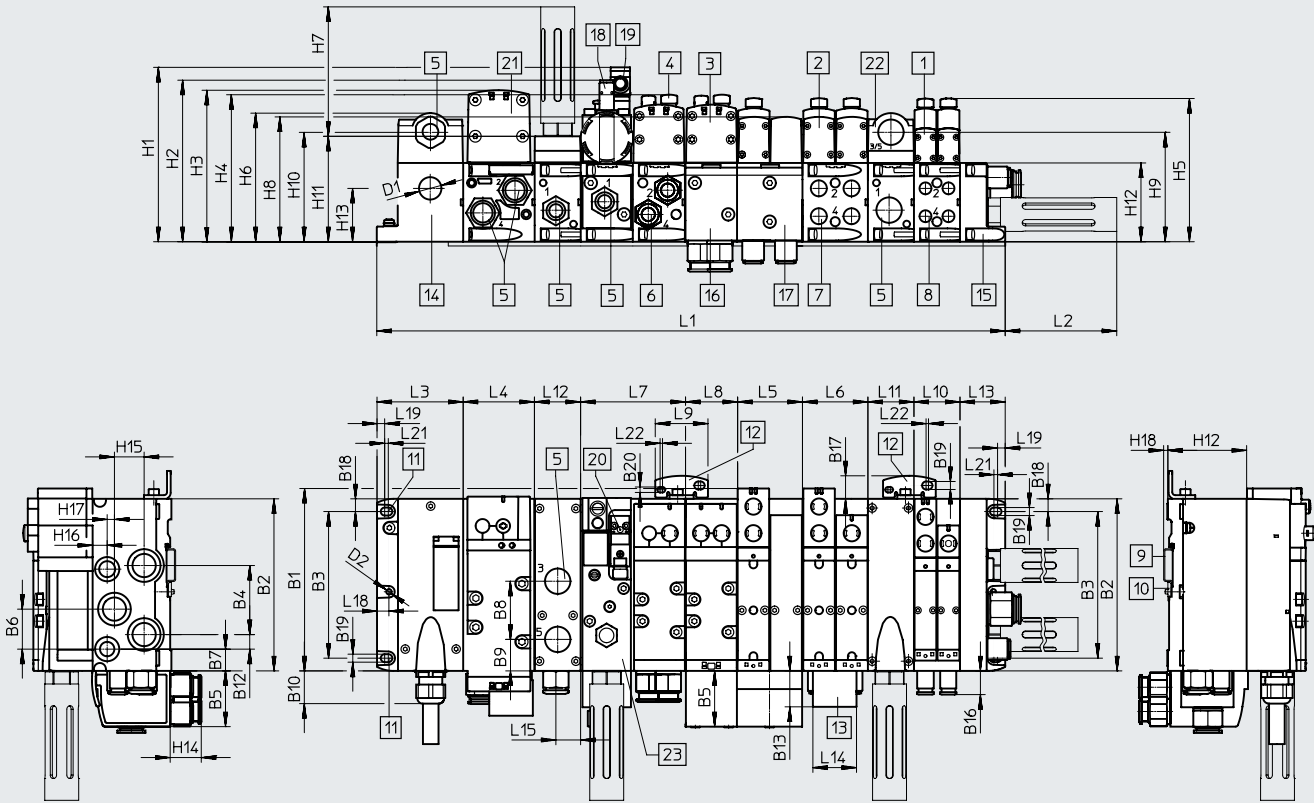

- [1] Solenoid valve
Width 18 mm
- [2] Solenoid valve
Width 26 mm
- [3] Solenoid valve
Width 42 mm
- [4] Cover cap/manual override
- [5] Threaded connection G1/2
- [6] Threaded connection G3/8
- [7] Threaded connection G1/4
- [8] Threaded connection G1/8
- [9] H-rail
- [10] H-rail mounting
- [11] Mounting hole
- [12] Additional mounting bracket
- [13] Inscription label holder
- [14] Multi-pin plug connection
- [15] End plate
- [16] 90°-connection plate 43 mm, G3/8
- [17] 90°-connection plate 54 mm, G1/4
- [18] Proximity switch M12x1
- [19] Plug socket M12x1
- [20] Electrical connection to EN 175301-803, type C
- [21] Solenoid valve width 52 mm
- [22] Supply plate
- [23] Soft-start valve
- N02 Number of manifold sub-bases 38 mm
- N01 Number of manifold sub-bases 54 mm
- N1 Number of manifold sub-bases 43 mm
- N2 Number of manifold sub-bases 59 mm
- n Number of supply plates (only with end plate with pilot air selector)

Dim.	B1	B2	B3	B4	B5	B6	B7	B8	B9	B10	B11	B12	B13	B14	B16	B17	B18	B19	B20
[mm]	150.5	142	121	57	46	33	18	48	26	27	2	12	29.6	23	19.5	19	10.5	6.6	4.5

Dim.	L2	L3	L4	L5	L6	L7	L8	L9	L10	L11	L12	L13	L14	L15	L16	L18	L19	L20	L21
[mm]	92.4	71.3	n2x59	n01x54	54	n1x43	43	43.5	n02x38	nx38	38	37.3	36	20.5	20	9.8	6.3	5.5	3

Dim.	L22	D1Ø	D2Ø	H1	H2	H3	H4	H5	H6	H7	H8	H9	H10	H11	H12	H13	H14	H15	H16	H17	H18
[mm]	2	18.5	4.5	143.9	133.3	125	121.3	118.2	106.3	107.8	103	90.3	90.3	87	65	44	25.7	24.5	12	6	3.5

Width	L1
18 mm	71.3 + n02 x 38 + n x 38 + 37.3
26 mm	71.3 + n01 x 54 + n x 38 + 37.3
42 mm	71.3 + n1 x 43 + n x 38 + 37.3
52 mm	71.3 + n2 x 59 + n x 38 + 37.3
Mixture of 18 mm, 26 mm, 42 mm and 52 mm	71.3 + n02 x 38 + n01 x 54 + n1 x 43 + n2 x 59 + n x 38 + 37.3

† Note: this product conforms to ISO 1179-1 and ISO 228-1.

Datasheet – Valve terminal

Dimensions

Download CAD data → www.festo.com

Multi-pin, terminal strip (Cage Clamp), VABE-S6-1LF-C-M1-C...

Multi-pin, round plug, VABE-S6-1LF-C-M1-R...

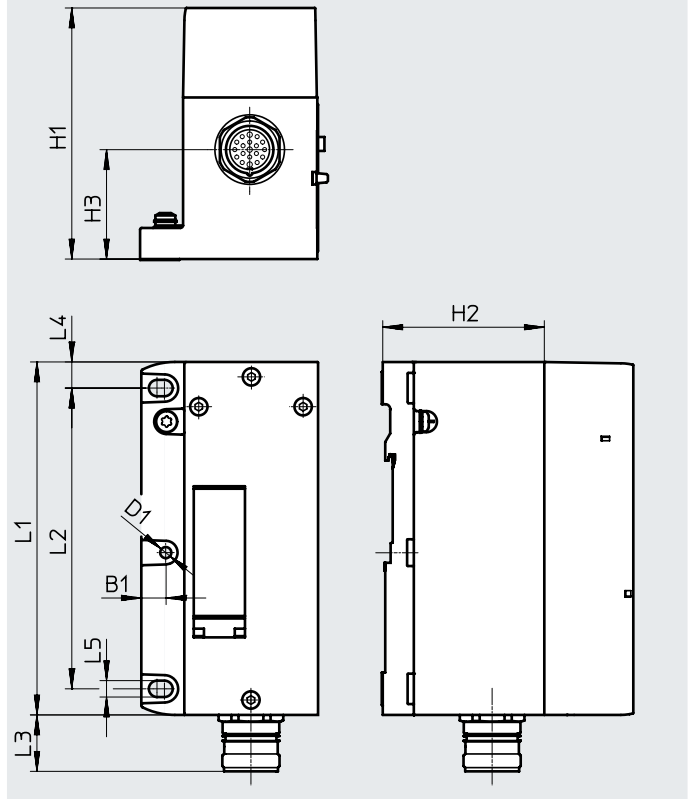
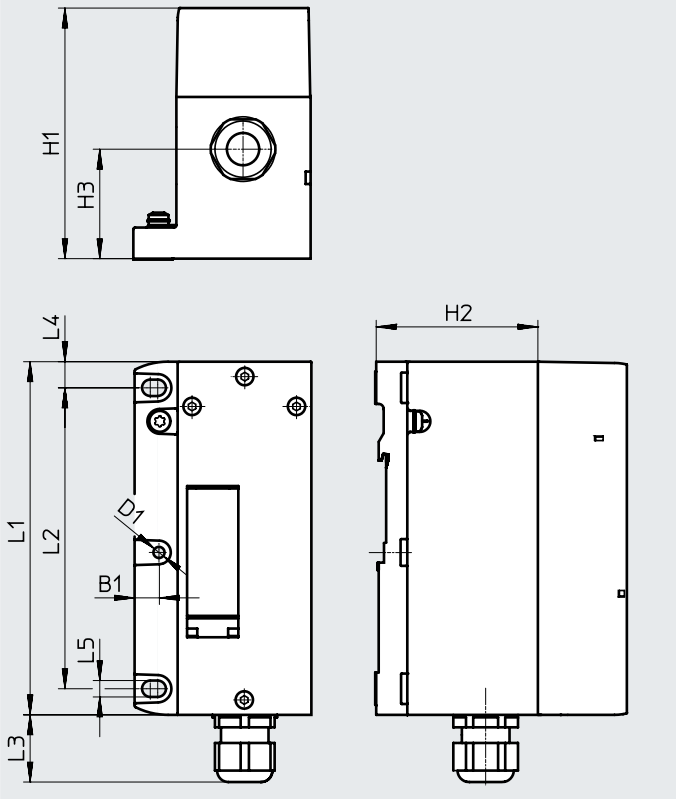

Type	H1	H2	H3	D1Ø	L1	L2	L3	L4	L5	B1
VABE-S6-1LF-C-M1-C...	106.1	65	44	4.5	142	121	27	10.5	6.6	9.8
VABE-S6-1LF-C-M1-R...	101	65	44	4.5	142	121	25	10.5	6.6	9.8

Datasheet – Valve terminal

Download CAD data → www.festo.com

Dimensions

AP interface

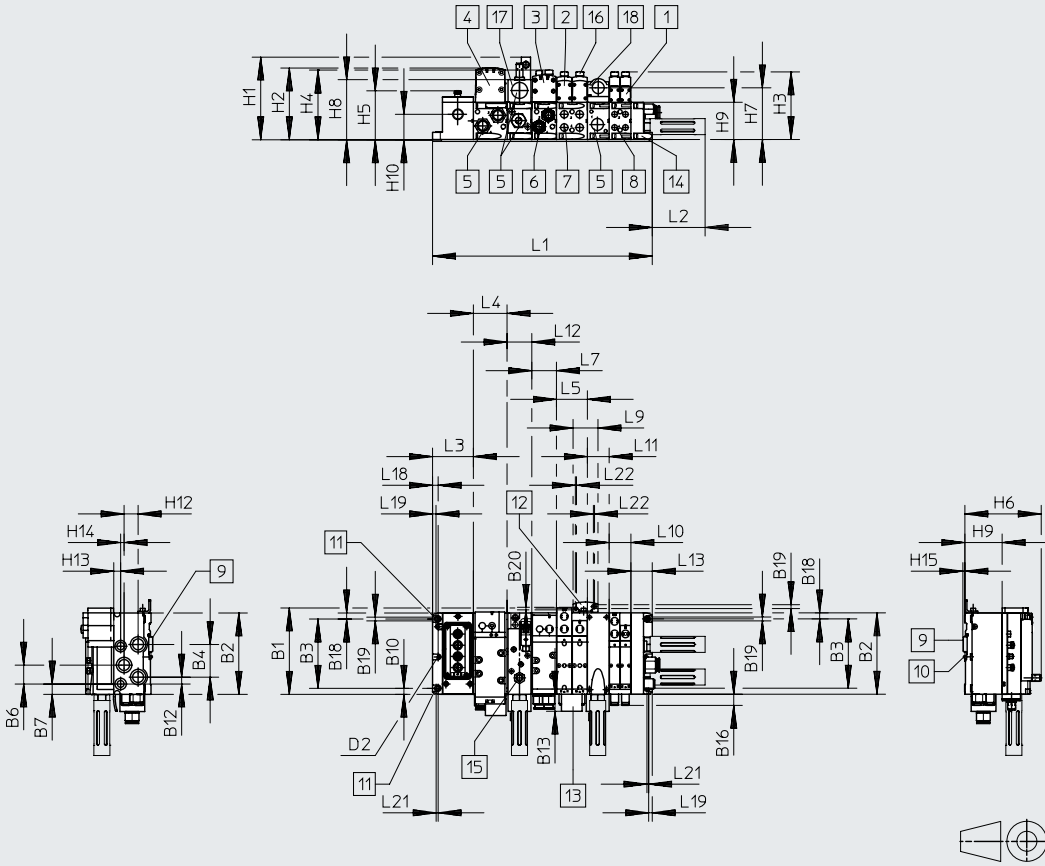

- [1] Solenoid valve 18 mm
- [2] Solenoid valve 26 mm
- [3] Solenoid valve 42 mm
- [4] Solenoid valve 52 mm
- [5] Threaded connection G1/2, 1/2 NPT
- [6] Threaded connection G3/8, 3/8 NPT
- [7] Threaded connection G1/4, 1/4 NPT
- [8] Threaded connection G1/8, 1/8 NPT
- [9] H-rail
- [10] H-rail mounting
- [11] Mounting hole
- [12] Additional mounting bracket
- [13] Inscription label
- [14] End plate
- [15] Proximity switch M12x1
- [16] Cover cap/manual override
- [17] Soft-start valve 43 mm
- [18] Supply plate

Type	B1	B2	B3	B4	B6	B7	B10	B12	B13	B16	B18	B19	B20	D2
VTSA-ASI-...	150.5	142	121	57	33	18	28	12	29.6	19.5	10.5	6.6	4.5	4.5

Type	H1	H2	H3	H4	H5	H6	H7	H8	H9	H10	H12	H13	H14	H15
VTSA-ASI-...	143.9	125	118.2	121.3	85.5	171	90.3	104.5	65	44.4	24.5	12	6	3.5

Type	L1
Valve size 18 mm	02: 71.3 + n02 x 38 + n x 38 + 37.3
Valve size 26 mm	01: 71.3 + n01 x 54 + n x 38 + 37.3
Valve size 42 mm	71.3 + n1 x 43 + n x 38 + 37.3
Valve size 52 mm	71.3 + n2 x 59 + n x 38 + 37.3
Mixture of 18 mm, 26 mm, 42 mm and 52 mm	02 + 01 + 1 + 2 71.3 + n02 x 38 + n01 x 54 + n1 x 43 + n2 x 59 + n x 38 + 37.3

Type	L2	L3	L4	L5	L7	L9	L10	L11	L12	L13	L18	L19	L21	L22
VTSA-ASI-...	92.4	71.3	n2 ¹⁾ x 59	n01 ²⁾ x 54	n1 ³⁾ x 43	43.5	n02 ⁴⁾ x 38	n ⁵⁾ x 38	43	37.3	9.8	6.3	3	2

1) Number of manifold sub-bases 59 mm
 2) Number of manifold sub-bases 54 mm
 3) Number of manifold sub-bases 43 mm
 4) Number of manifold sub-bases 38 mm
 5) Number of manifold sub-bases

Datasheet – Valve terminal

Dimensions

Download CAD data → www.festo.com

Valve terminal with AS-Interface connection

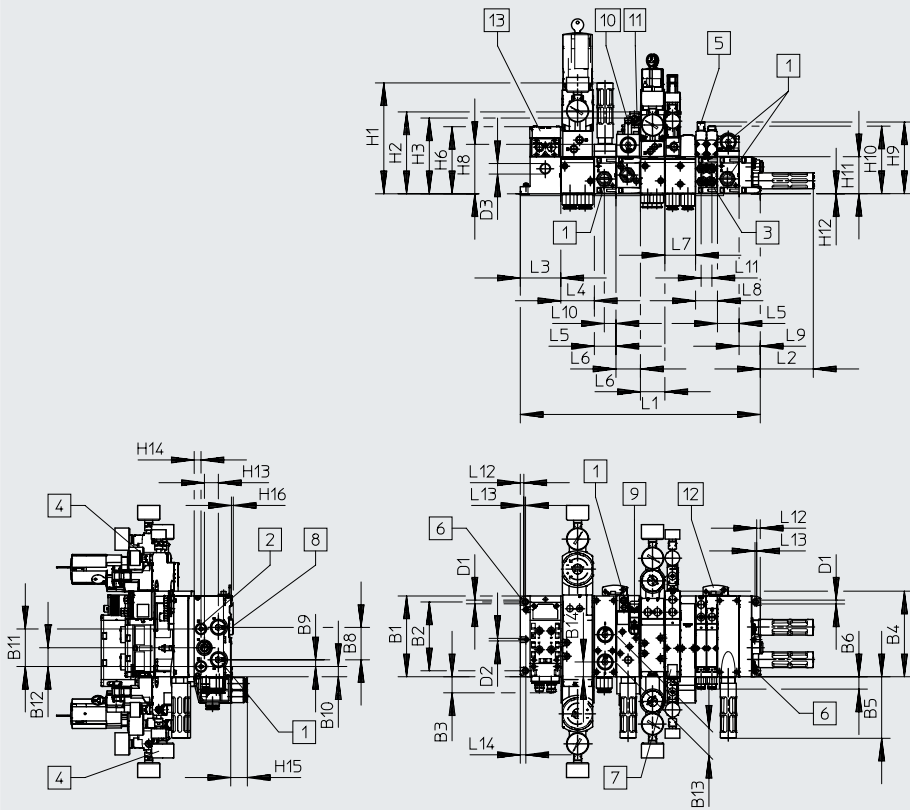

- | | | | |
|---|---|------|-------------------------------------|
| [1] Threaded connection G1/2 | [7] Inscription label | n02 | Number of manifold sub-bases ISO 02 |
| [2] Threaded connection G1/4 | [8] H-rail mounting | n01 | Number of manifold sub-bases ISO 01 |
| [3] Threaded connection G1/8 | [9] Electrical connection to DIN EN 175301-803 type C | n1 | Number of manifold sub-bases ISO 1 |
| [4] Pressure gauge, freely positionable | [10] Proximity switch M12x1 | n2 | Number of manifold sub-bases ISO 2 |
| [5] Manual override | [11] Plug socket M12 | nZWP | Number of supply plates |
| [6] Mounting holes | [12] Additional mounting bracket | nDA | Number of soft-start valves |
| | [13] Electrical interface for AS-Interface | | |

Dim.	B1	B2	B3	B4	B5	B6	B8	B9	B10	B11	B12	B13	B14	D1	D2	D3
[mm]	142	121	28	150.5	108.1	21.6	57	12	18	66	33	48	26	6.6	4.5	18.5

Dim.	H1	H2	H3	H6	H8	H9	H10	H11	H12	H13	H14	H15	H16
[mm]	195.2	144	133.4	118	87	126	118.8	65	0.4	24.4	12	29.3	3.5

Dim.	L1	L2	L3	L4	L5	L6	L7	L8	L9	L10	L11	L12	L13	L14
[mm]	578.3	93.2	71.3	59	38	43	54	38.6	37.3	20.5	19	6.3	3	9.8

ISO size	Sub-bases width	Total length
02 + ZWP	38	$108.6 + n02 * 38 + nZWP * 38 + nDA * 43$
01	54	$108.6 + n01 * 54 + nZWP * 38 + nDA * 43$
1 + DA	43	$108.6 + n1 * 43 + nZWP * 38 + nDA * 43$
2	59	$108.6 + n2 * 59 + nZWP * 38 + nDA * 43$
Mixture of 02 + 01 + 1 + 2	$38 + 54 + 43 + 59$	$108.6 + n02 * 38 + n01 * 54 + n1 * 43 + nZWP * 38 + n2 * 59 + nDA * 43$

Datasheet – Valve terminal

Dimensions

Valve terminal with fieldbus interface

Download CAD data → www.festo.com

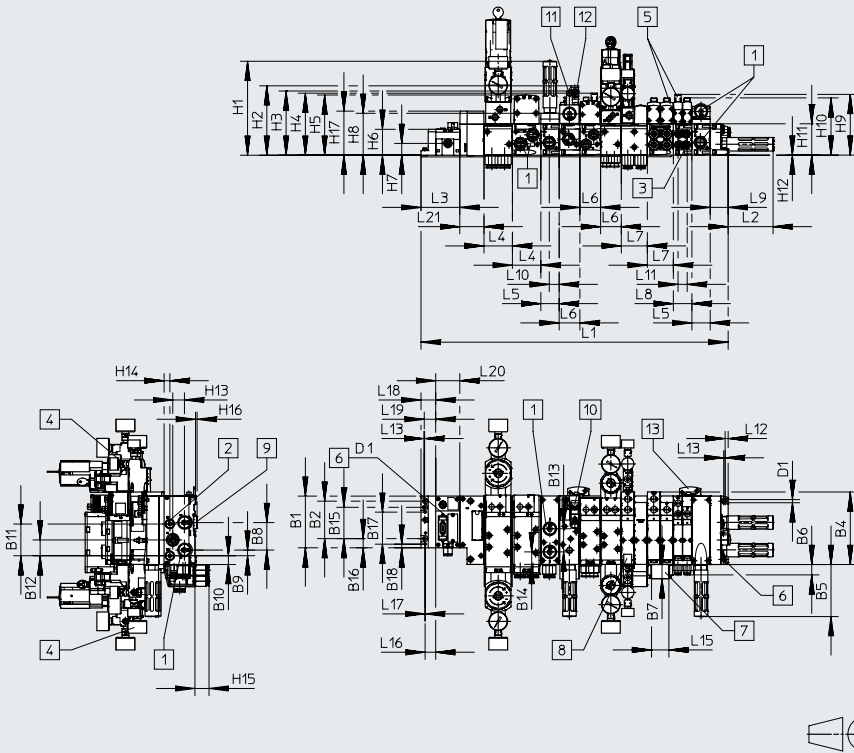

- | | | | | |
|---|-----------------------|--|-----|---|
| [1] Threaded connection G1/2 | [5] Manual override | [9] H-rail mounting | n02 | Number of manifold sub-bases ISO 02 |
| [2] Threaded connection G1/4 | [6] Mounting holes | [10] Electrical connection to DIN EN 175301-803 type C | n01 | Number of manifold sub-bases ISO 01 |
| [3] Threaded connection G1/8 | [7] Inscription label | [11] Proximity switch M12x1 | n1 | Number of manifold sub-bases ISO 1 |
| [4] Pressure gauge, freely positionable | [8] Inscription label | [12] Plug socket M12 | n2 | Number of manifold sub-bases ISO 2 |
| | | [13] Additional mounting bracket | n | Number of supply plates (only with end plate with pilot air selector) |
| | | | nDA | Number of soft-start valves |
| | | | m | Number of CPX modules |

Dim.	B1	B2	B4	B5	B6	B7	B8	B9	B10	B11	B12	B13	B14	B15	B16	B17	B18	D1	D3
[mm]	107.3	78	150.5	108.1	21.6	29.4	57	12	18	66	33	48	26	65	18.9	66.3	7.5	6.6	4.5

Dim.	L1	L2	L3	L4	L5	L6	L7	L8	L9	L10	L11	L13	L15	L17	L18	L19	L20	L21
[mm]	587.5	93.2	80.5	59	38	43	54	38.6	37.3	20.5	19	3	36	1	30.4	23.7	mx50	50

Dim.	H1	H2	H3	H4	H5	H6	H7	H8	H9	H10	H11	H12	H13	H14	H15	H16	H17
[mm]	195.2	144	133.4	128.7	125	55.1	25.8	87	126	118.8	65	0.4	24.4	12	29.3	3.5	91.6

ISO size	Sub-bases width	L1
02 + ZWP	38	117.7 + n02 * 38 + nZWP * 38 + nDA * 43
01	54	117.7 + n01 * 54 + nZWP * 38 + nDA * 43
1 + DA	43	117.7 + n1 * 43 + nZWP * 38 + nDA * 43
2	59	117.7 + n2 * 59 + nZWP * 38 + nDA * 43
Mixture of 02 + 01 + 1 + 2	38 + 54 + 43 + 59	117.7 + n02 * 38 + n01 * 54 + n1 * 43 + nZWP * 38 + n2 * 59 + nDA * 43

† Note: this product conforms to ISO 1179-1 and ISO 228-1.

Datasheet – Valve terminal

Dimensions

Download CAD data → www.festo.com

Valve terminal VTSA-F-CB with fieldbus interface

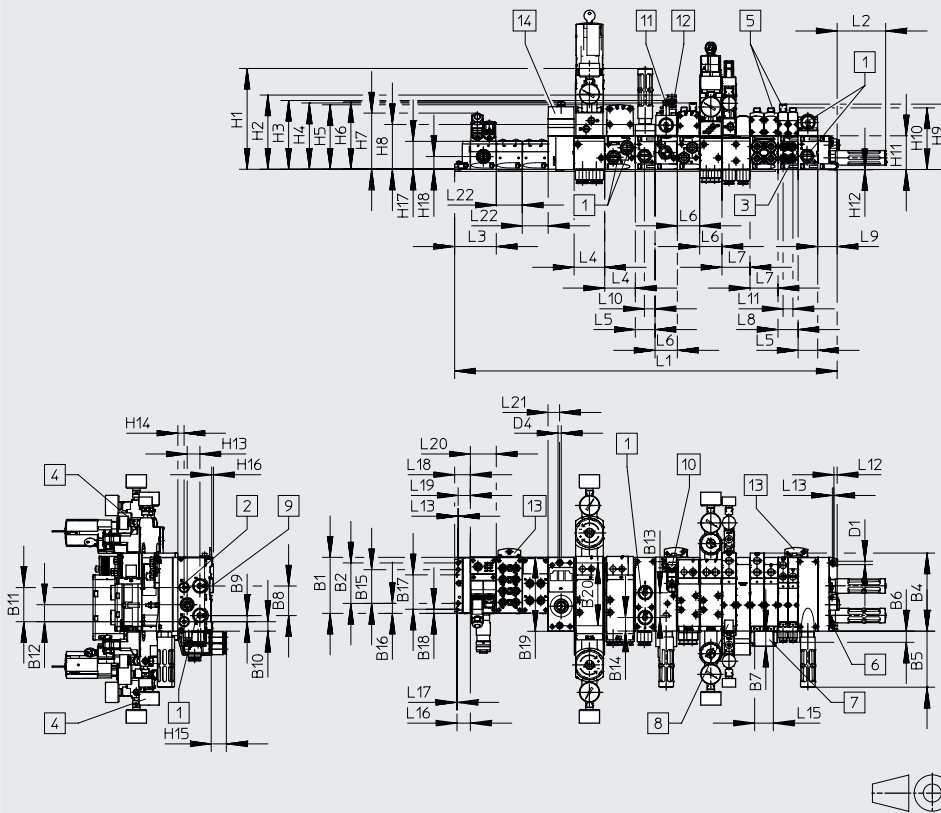

- [1] Threaded connection G1/2
 - [2] Threaded connection G1/4
 - [3] Threaded connection G1/8
 - [4] Pressure gauge, freely positionable
 - [5] Manual override
 - [6] Mounting holes
 - [7] Inscription label
 - [8] Inscription label
 - [9] H-rail mounting
 - [10] Electrical connection to DIN EN 175301-803 type C
 - [11] Proximity switch M12x1
 - [12] Plug socket M12
 - [13] Additional mounting bracket
 - [14] Pneumatic interface CPX
- n02 Number of manifold sub-bases ISO 02
- n01 Number of manifold sub-bases ISO 01
- n1 Number of manifold sub-bases ISO 1
- n2 Number of manifold sub-bases ISO 2
- nZWP Number of supply plates
- nDA Number of soft-start valves
- m Number of CPX modules

Dim.	B1	B2	B4	B5	B6	B7	B8	B9	B10	B11	B12	B13	B14	B15	B16	B17	B18	B19	B20
[mm]	108.1	78	150.5	108.1	21.6	29.4	57	12	18	66	33	48	26	65	19.3	66.3	7.9	142.6	121

Dim.	D4	H1	H2	H3	H4	H5	H6	H7	H8	H9	H10	H11	H12	H13	H14	H15	H16	H17	H18
[mm]	6.6	195.2	103.3	133.4	128.7	125	106.5	108.3	87	126	118.8	65	0.4	24.4	12	29.3	3.5	53.8	24.5

Dim.	L1	L2	L3	L4	L5	L6	L7	L8	L9	L10	L11	L13	L15	L16	L17	L18	L19	L20	L21	L22
[mm]	557	93.2	80.3	59	38	43	54	38.6	37.3	20.5	19	1.5	36	25.9	1	30.4	23.7	mx50.1	22.3	50.1

ISO size	Sub-bases width	Total length
02 + ZWP	38	117.7 + n02 * 38 + nZWP * 38 + nDA * 43
01	54	117.7 + n01 * 54 + nZWP * 38 + nDA * 43
1 + DA	43	117.7 + n1 * 43 + nZWP * 38 + nDA * 43
2	59	117.7 + n2 * 59 + nZWP * 38 + nDA * 43
Mixture of 02 + 01 + 1 + 2	38 + 54 + 43 + 59	117.7 + n02 * 38 + n01 * 54 + n1 * 43 + nZWP * 38 + n2 * 59 + nDA * 43

Datasheet – Valve terminal

Download CAD data → www.festo.com

Dimensions

Vertical stacking components, width 18 mm

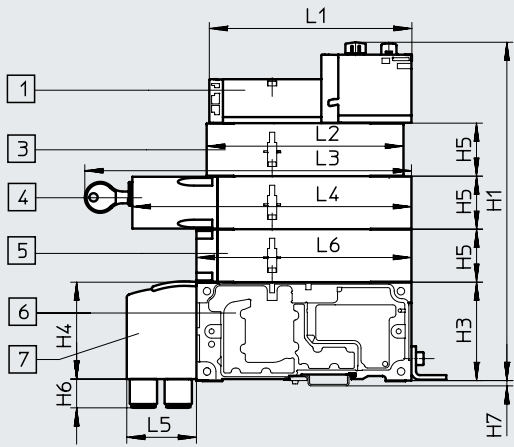

- [1] Solenoid valve with two solenoid coils, width 18 mm
- [3] Throttle plate
- [4] Vertical pressure shut-off plate lockable (code ZT), optionally lockable with key (code ZS)
- [5] Vertical supply plate
- [6] Manifold sub-base
- [7] 90°-connection plate

Dim.	L1	L2	L3 (Code ZT)	L4 (Code ZT)	L3 (Code ZS)	L4 (Code ZS)	L5	L6	H1	H3	H4	H5	H6	H7
[mm]	133.8	130	-	184.1	222.3	198.3	46	142	224	65	64	35	19	3.5

Vertical stacking components, width 18 mm

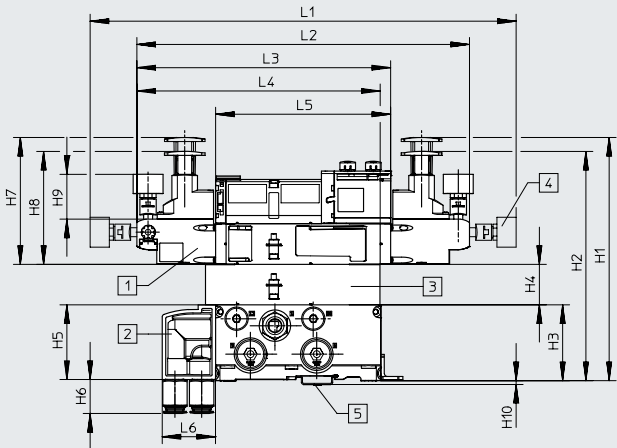

- [1] Solenoid valve with two solenoid coils, width 18 mm
- [2] Pressure regulator plate
- [3] Throttle plate
- [4] Pressure gauge, freely position-able
- [5] H-rail mounting

Dim.	H1	H2	H3	H4	H5	H6	H7	H8	H9	H10	L1	L2	L3	L4	L5	L6
[mm]	209	197.1	65	34.9	64	25.7	109.1	97.3	38.6	3.5	366.4	286.1	218.3	209.3	150.5	46

Vertical stacking components, width 18 mm, with the pressure regulator plate also suitable for valves with symmetrical design

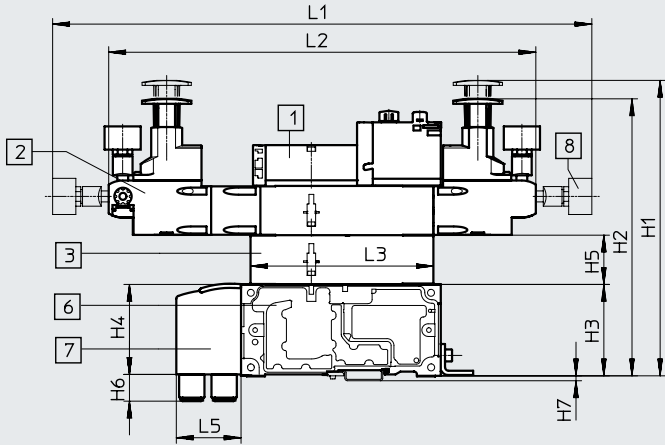

- [1] Solenoid valve with two solenoid coils, width 18 mm
- [2] Pressure regulator plate
- [3] Throttle plate
- [6] Manifold sub-base
- [7] 90°-connection plate
- [8] Pressure gauge, freely position-able

Datasheet – Valve terminal

Dimensions

Download CAD data → www.festo.com

Vertical stacking components, width 26 mm

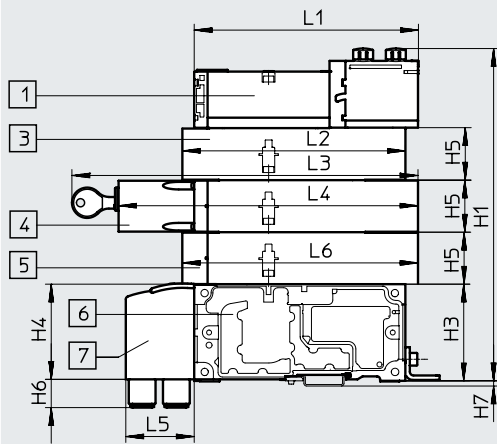

- [1] Solenoid valve with two solenoid coils, width 26 mm
- [3] Throttle plate
- [4] Vertical pressure shut-off plate, lockable (code ZT), optionally lockable with key (code ZS)
- [5] Vertical supply plate
- [6] Manifold sub-base
- [7] 90°-connection plate

Dim.	L1	L2	L3 (Code ZT)	L4 (Code ZT)	L3 (Code ZS)	L4 (Code ZS)	L5	L6	H1	H3	H4	H5	H6	H7
[mm]	150.8	150	-	201.4	239.5	215.5	46	158.5	224	65	64	35	19	3.5

Vertical stacking components, width 26 mm

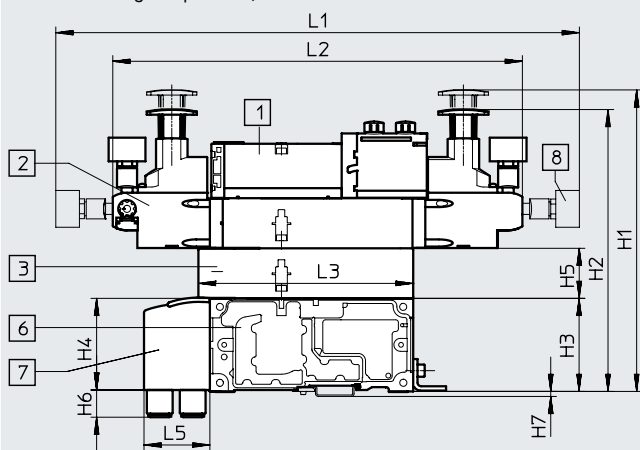

- [1] Solenoid valve with two solenoid coils, width 26 mm
- [2] Pressure regulator plate
- [3] Throttle plate
- [6] Manifold sub-base
- [7] 90°-connection plate
- [8] Pressure gauge, freely positionable

Dim.	L1	L2	L3	L5	H1	H2	H3	H4	H5	H6	H7
[mm]	365.7	286.1	150	46	210	197	65	64	35	19	3.5

Vertical stacking components, width 26 mm, with the pressure regulator plate also suitable for valves with symmetrical design

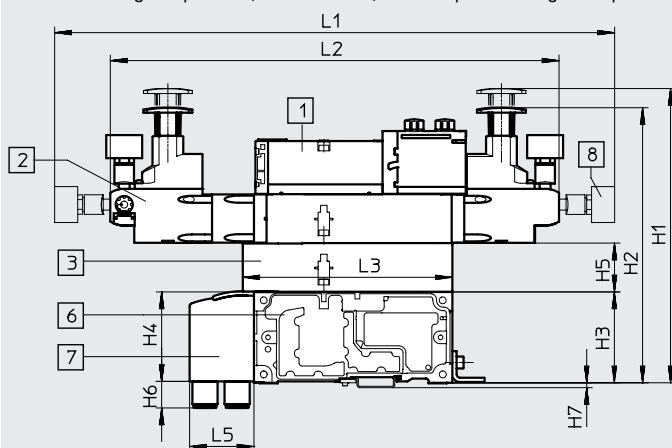

- [1] Solenoid valve with two solenoid coils, width 26 mm
- [2] Pressure regulator plate
- [3] Throttle plate
- [6] Manifold sub-base
- [7] 90°-connection plate
- [8] Pressure gauge, freely positionable

Dim.	L1	L2	L3	L5	H1	H2	H3	H4	H5	H6	H7
[mm]	400.7	321.1	150	46	210	197	65	64	35	19	3.5

Datasheet – Valve terminal

Dimensions

Download CAD data → www.festo.com

Vertical stacking components, width 42 mm

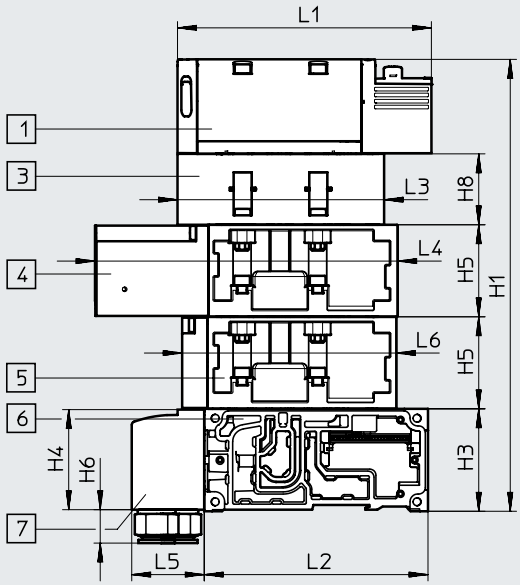

- [1] Solenoid valve
- [3] Throttle plate
- [4] Vertical pressure shut-off plate
- [5] Vertical supply plate
- [6] Manifold sub-base
- [7] 90°-connection plate

Dim.	L1	L2	L3	L4	L5	L6	H1	H3	H4	H5	H6	H7	H8
[mm]	137.8	142	105.3	173.8	46	117.6	236	65	64	45.3	25.7	3.5	28

Vertical stacking components, width 42 mm

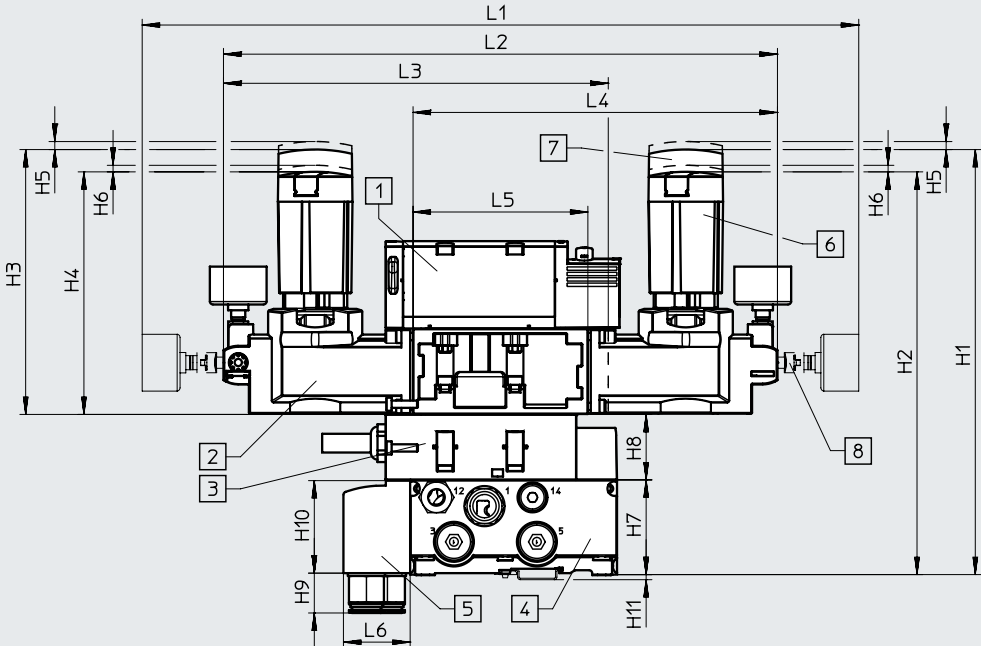

- [1] Solenoid valve
- [2] Pressure regulator plate
- [3] Throttle plate
- [4] Manifold sub-base
- [5] 90°-connection plate
- [6] Short rotary knob, lockable (standard)
- [7] Long rotary knob, lockable
- [8] Pressure gauge, freely positionable

Dim.	L1	L2	L3	L4	L5	L6	H1	H2	H3	H4	H5	H6	H7	H8	H9	H10	H11
[mm]	410.3	311.6	216.1	207.1	102.6	46	220	205	127	112	3	4.2	65	28	25.7	64	3.5

Note

• Pressure regulator plates for symmetrically designed valves with widths of 42 mm and 52 mm can only be ordered via the pressure regulator configurator VABF-S2.

The following can be selected using the pressure regulator configurator VABF-S2:

- Rotary knob, short version with locking element (standard)
- Rotary knob, long version with locking element
- Rotary knob with integrated lock

→ Internet: vabf-s2

Datasheet – Valve terminal

Dimensions

Download CAD data → www.festo.com

Vertical stacking components, width 52 mm

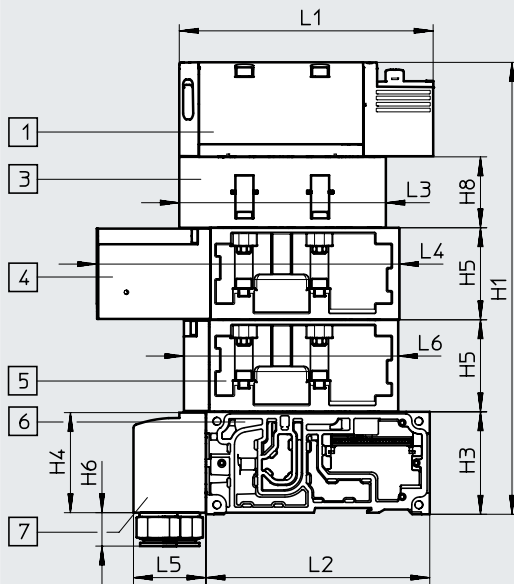

- [1] Solenoid valve
- [3] Throttle plate
- [4] Vertical pressure shut-off plate
- [5] Vertical supply plate
- [6] Manifold sub-base
- [7] 90°-connection plate

Dim.	L1	L2	L3	L4	L5	L6	H1	H3	H4	H5	H6	H8
[mm]	160.7	142	131	191.2	46	136	287.4	65	63.5	58.7	21.2	45

Vertical stacking components, width 52 mm

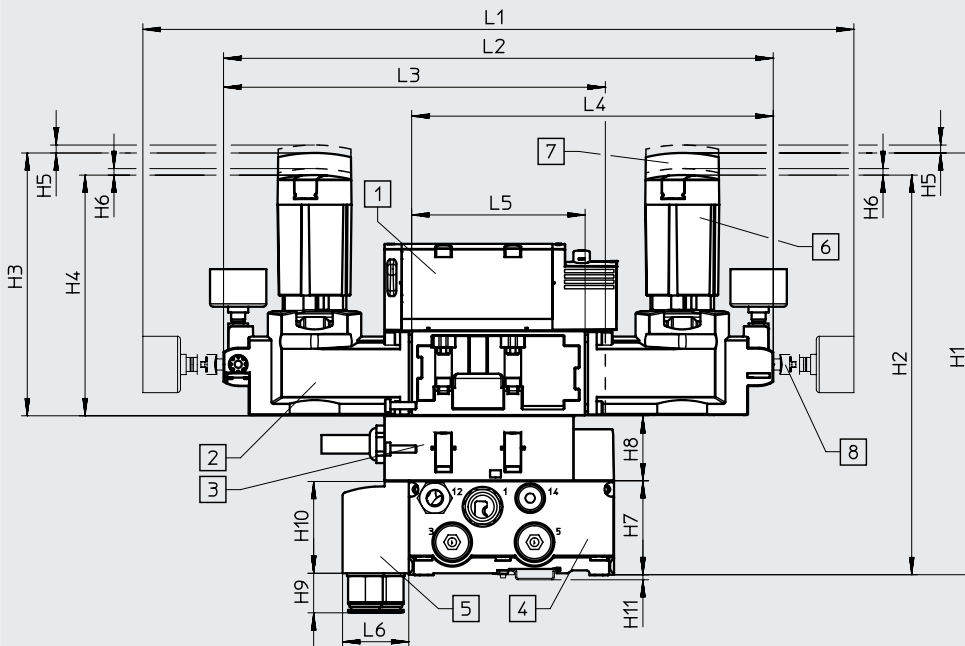

- [1] Solenoid valve
- [2] Pressure regulator plate
- [3] Throttle plate
- [4] Manifold sub-base
- [5] 90°-connection plate
- [6] Short rotary knob, lockable (standard)
- [7] Long rotary knob, lockable
- [8] Pressure gauge, freely positionable

Dim.	L1	L2	L3	L4	L5	L6	H1	H2	H3	H4	H5	H6	H7	H8	H9	H10	H11
[mm]	492	380.4	264.2	250.2	120	45.8	291	276	181	166	5.5	4.5	65	45	27.4	63.5	3.5

Note

- Pressure regulator plates for symmetrically designed valves with widths of 42 mm and 52 mm can only be ordered via the pressure regulator configurator VABF-S2.

The following can be selected using the pressure regulator configurator VABF-S2:

- Rotary knob, short version with locking element (standard)
- Rotary knob, long version with locking element
- Rotary knob with integrated lock

→ Internet: vabf-s2

Datasheet – Valve terminal

Dimensions

Supply plate with silencer

Download CAD data → www.festo.com

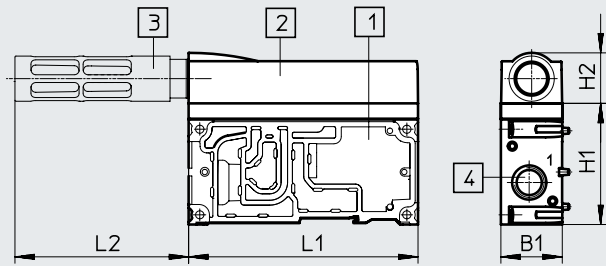

- [1] Supply plate
- [2] Exhaust port cover
- [3] Silencer U-1/2-B
- [4] Threaded connection G1/2

Dim.	L1	L2	H1	H2	B1
[mm]	142	107.5	75	31.5	38

Right end plate, VABE-S6-1R...

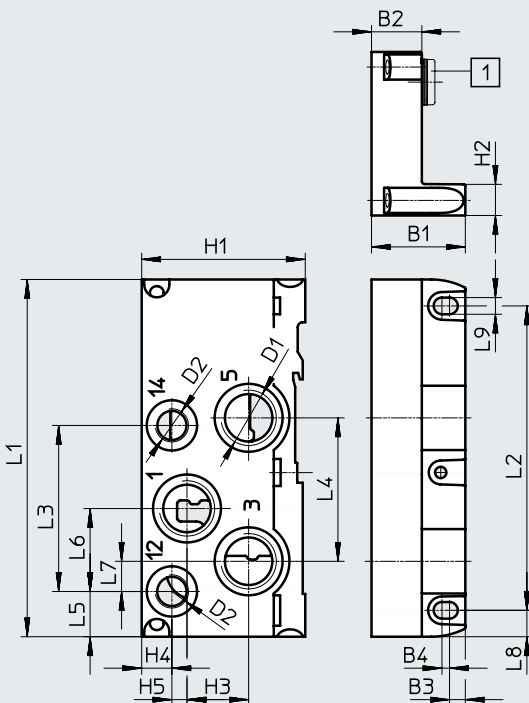

[1] Blanking plug

Right end plate, VABE-S6-2R...

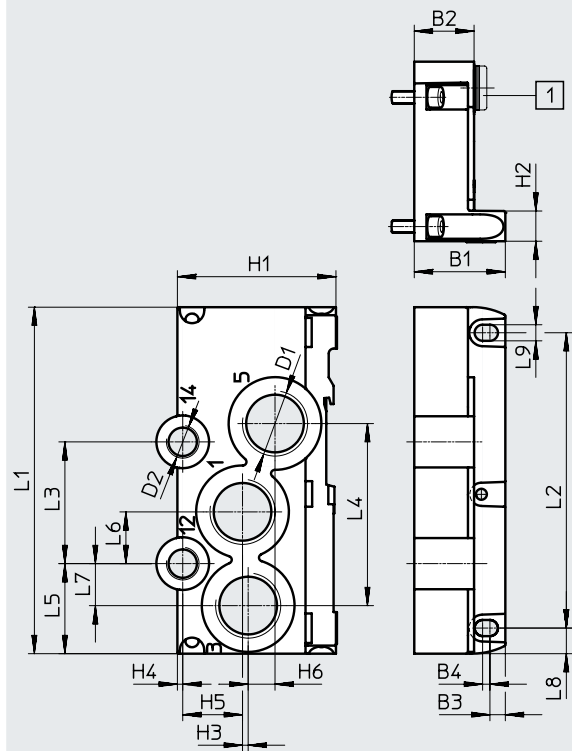

[1] Blanking plug

Type	L1	L2	L3	L4	L5	L6	L7	L8	L9	D1	D2	H1	H2	H3	H4	H5	H6	B1	B2	B3	B4	With ¹⁾
VABE-S6-1R-G12	142	121	66	57	18	33	12	10.5	6.6	G1/2	G1/4	65	12.5	24.5	12	6	-	37.3	22	6.3	3	[1]
VABE-S6-1RZ-G12																						-
VABE-S6-2R-G34	142	121	49.9	74.6	36.9	21.2	17.2	10.5	6.6	G3/4	G1/4	65	12.5	2.3	2.2	24.5	11	37.3	24.5	6.3	3	[1]
VABE-S6-2RZ-G34																						-

1) With blanking plug = internal pilot air supply, – without blanking plug = external pilot air supply

Special feature: There is no port 14 for VABE-S6-1R-G12 (code V).

† Note: this product conforms to ISO 1179-1 and ISO 228-1.

Datasheet – Valve terminal

Dimensions

Download CAD data → www.festo.com

Right end plate with pilot air selector, VABE-S6-1RZ-G-B1

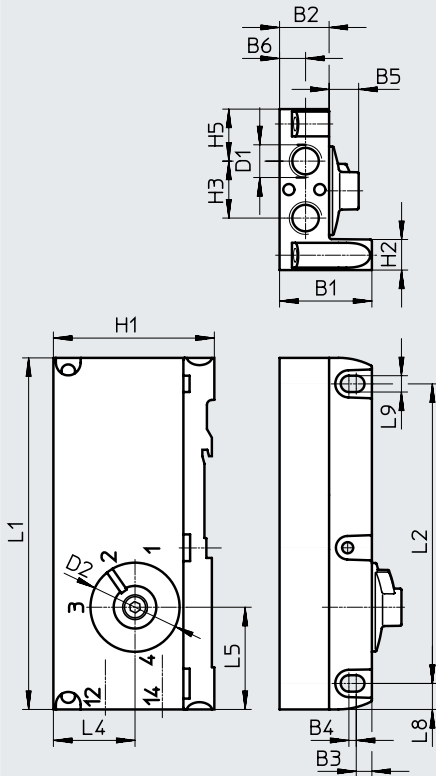

Type	L1	L2	L5	L8	L9	D1	D2	H1	H2	H3	H4	H5	B1	B2	B3	B4	B5	B6
VABE-S6-1RZ-G-B1	142	121	41.3	10.5	6.6	G1/4	37	65.4	12.5	23	33	21	37.3	20	6.3	3	12	10.5

† Note: this product conforms to ISO 1179-1 and ISO 228-1.

Datasheet – Solenoid valves VSVA

-  Valve width
to ISO 15407-2
- 18 mm
 - 26 mm
- to ISO 5599-2
- 42 mm (ISO 1)
 - 52 mm (ISO 2)

-  Voltage
24 V DC

-  Flow rate¹⁾
- Width 18 mm: up to
550 (700) l/min
- Width 26 mm: up to
1100 (1350) l/min
- Width 42 mm: up to
1300 (1860) l/min
- Width 52 mm
up to 2900 l/min

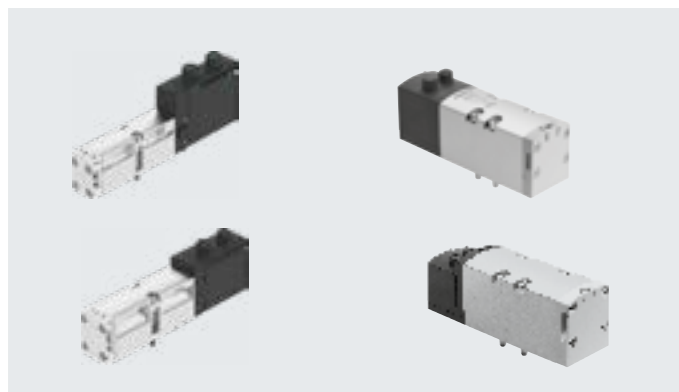

1) Flow rates in brackets apply to VTSA-F and VTSA-F-CB

General technical data for solenoid valves		
Design	Piston spool valve	
Sealing principle	Soft	
Overlap	Positive overlap (excluding types P53AD, P53BD)	
	Negative overlap (types P53AD, P53BD)	
Reset method	Mechanical or pneumatic, depending on the type used	
Actuation type	Electrical	
Electrical connection	Plug to ISO 15407-2, 2-pin (single solenoid types) or 4-pin (double solenoid and 5/3-way types)	
Type of actuation	Piloted	
Degree of protection to EN 60529	IP65, NEMA 4 (for all types of signal transmission when mounted)	
Exhaust function, can be throttled	Via individual sub-base, via throttle plate (not with valve type T22)	
Type of mounting	On manifold sub-base, on individual sub-base	
Mounting position	Any	
Manual override	Detenting, non-detenting, concealed	
Signal status display	LED (except types with signal status display sensor, and part nos.: 560727 and 560728)	
Sensor signal status indication	Yellow LED	
Duty cycle [%]	100	
Pollution degree	3	
Surge resistance [kV]	2.5	
Nominal operating voltage [V DC]	24 (dependent on valve type)	
Permissible voltage fluctuations [%]	±10	
Pneumatic connections		
Supply	1	Via the manifold sub-base of the valve terminal or via individual sub-base
Exhausting	3/5	
Working ports	2/4	
Pilot air supply	1 2/14	
Pilot exhaust air	8 2/84	Either ducted or unducted

Datasheet – Solenoid valves

Pneumatic characteristic data										
Terminal code	VC	VV	N	K	H	P	Q	R	M	O
Valve code	T22C	T22CV	T32U	T32C	T32H	T32F	T32N	T32W	M52-A	M52-M
Flow direction										
Any	–	■	–	–	–	–	–	–	■	■
Reversible only	–	–	–	–	–	■	■	■	–	–
Not reversible	■	–	■	■	■	–	–	–	–	–
Reset method										
Pneumatic spring	■	■	■	■	■	■	■	■	■	–
Mechanical spring	–	–	–	–	–	–	–	–	–	■

Pneumatic characteristic data										
Terminal code	J	D	B	G	E	SA	SB	SD	SE	VG
Valve code	B52	D52	P53U	P53C	P53E	P53ED	P53AD	P53BD	P53EP	P53F
Flow direction										
Any	■	■	■	■	■	–	■	–	–	■
Reversible only	–	–	–	–	–	–	–	–	–	–
Not reversible	–	–	–	–	–	■	–	■	■	–
Reset method										
Pneumatic spring	–	–	–	–	–	–	–	–	–	–
Mechanical spring	–	–	■	■	■	■	■	■	■	■

Flow direction of solenoid valves

Solenoid valves only with reversible flow direction

- These valves must only be operated on pressure zones with reversible supply (3 and 5 with supply pressure 1 as exhaust air) or on a reversible pressure regulator. If necessary, create separate pressure zones with duct separation.
- Reversible 3/2-way solenoid valves do not permit the special function "ducted pilot exhaust air"
- Ports 12 and 14 on the end plate variants must be supplied with the same pressure.
- Right end plate with pilot air selector: can be realised via position 1 or 2
- Right end plate with threaded connections: 12 and 14 must be supplied with the same pressure level

Solenoid valves with any flow direction

- Valves with any flow direction such as the 5/2-way solenoid valve, code M, are suitable for vacuum operation (standard valves such as the 2x 2/2-way solenoid valve with code VC must not be used for vacuum operation).
- An exception is the 2x 2/2-way solenoid valve with code VV (T22CV), which only allows vacuum operation at ports 3 and 5. The solenoid valve with code VV (T22CV) cannot be combined with other valve functions; a separate pressure zone is required.

Datasheet – Solenoid valves

Operating and environmental conditions		
Operating medium		Compressed air to ISO 8573-1:2010 [7:4:4]
Pilot medium		Compressed air to ISO 8573-1:2010 [7:4:4]
Notes on operating/ Pilot medium		Lubricated operation possible (in which case lubricated operation will always be required)
Operating pressure, pilot air supply ²⁾	[bar]	-0.9 ... +10 (valves with any flow direction and reversible valves)
		3 ... 10 (non-reversible valves)
	[MPa]	-0.09 ... +1 (valves with any flow direction and reversible valves)
		0.3 ... 1 (non-reversible valves)
Pilot pressure	[bar]	3 ... 10
	[MPa]	0.3 ... 1
Pilot air supply		External
		Internal via valve terminal
Ambient temperature	[°C]	-5 ... +50
Relative humidity	[%]	0 ... 90
Certification		BIA (for characteristic SP and/or SN only)
	Direct voltage 24 V DC	C-Tick (only size 52 mm and solenoid valves with sensor (position sensing))
		c UL us – Recognized (OL)
CE marking (see declaration of conformity)	Direct voltage 24 V DC	To EU EMC Directive ¹⁾

1) For information about the area of use, see the EC declaration of conformity at: www.festo.com/catalogue/... → Support/Downloads.

If the devices are subject to usage restrictions in residential, commercial or light-industrial environments, further measures for the reduction of the emitted interference may be necessary.

2) Solenoid valves with code VC (2/2-way type ... T22C), N (3/2-way type ... T32U), K (3/2-way type ... T32C), H (3/2-way type ... T32H) must not be operated with vacuum; the operating pressure here is 3 ... 10 bar

Datasheet – Solenoid valve width 18 mm

-  - Valve width
to ISO 15407-2
18 mm

-  - Flow rate
Valve width 18 mm:
VTSA up to 550 l/min
VTSA-F up to 700 l/min
VTSA-F-CB up to 700 l/min

-  - Voltage
24 V DC



Safety characteristics for valve

Conforms to	EN 13849-1/2
CE marking (see declaration of conformity)	Direct voltage 24 V DC To EU EMC Directive ¹⁾ (solenoid valves with sensor only)
Shock resistance	Shock test with severity level 2, to EN 60068-2-27
Vibration resistance	Transport application test with severity level 2, to EN 60068-2-6

1) For information about the area of use, see the EC declaration of conformity at: www.festo.com/catalogue/... → Support/Downloads.
If the devices are subject to usage restrictions in residential, commercial or light-industrial environments, further measures for the reduction of the emitted interference may be necessary.

Safety characteristics for valve, 24 V DC

Valve function (with valve code)	Terminal code	Test pulses	
		Max. positive test pulse with logic 0 [µs]	Max. negative test pulse with logic 1 [µs]
5/2-way, double solenoid (B52)	J	1500	800
5/2-way, double solenoid with dominant signal (D52)	D	1700	1200
5/2-way, single solenoid (M52-A)	M	1500	800
5/2-way, single solenoid (M52-M)	O	1500	800
5/3-way, closed (P53C)	G	1500	800
5/3-way, exhausted (P53E)	E	1500	800
5/3-way, pressurised (P53U)	B	1500	800
5/3-way, exhausted, switching position 14 detenting (P53ED)	SA	1500	800
5/3-way, exhausted, switching position 12 detenting (P53EP)	SE	1500	800
5/3-way, port 2 pressurised, 4 exhausted, switching position 14 detenting (P53AD)	SB	1500	800
5/3-way, port 4 pressurised, 2 exhausted, switching position 14 detenting (P53BD)	SD	1500	800
2x3/2-way, single solenoid, closed (T32C)	K	1700	1200
2x3/2-way, single solenoid, open (T32U)	N	1700	1200
2x3/2-way, single solenoid, open/closed (T32H)	H	1700	1200
2x3/2-way, single solenoid, closed (T32N)	Q	1700	1200
2x3/2-way, single solenoid, open (T32F)	P	1700	1200
2x3/2-way, single solenoid, open/closed (T32W)	R	1700	1200
2x2/2-way, single solenoid, closed (T22C)	VC	1700	1200
2x2/2-way, single solenoid, closed (T22CV)	VV	1700	1200

Datasheet – Solenoid valve width 18 mm

Datasheet for valve							
Valve function (with valve code)	Terminal code	Flow direction			Reset method		Weight [g]
		Any	Reversible only	Not reversible	Pneumatic spring	Mechanical spring	
5/2-way, double solenoid (B52)	J	■	–	–	–	–	172
5/2-way, double solenoid with dominant signal (D52)	D	■	–	–	–	–	172
5/2-way, single solenoid (M52-A)	M	■	–	–	■	–	163
5/2-way, single solenoid (M52-M)	O	■	–	–	–	■	163
5/3-way, closed ¹⁾ (P53C)	G	■	–	–	–	■	191
5/3-way, exhausted ¹⁾ (P53E)	E	■	–	–	–	■	191
5/3-way, pressurised ¹⁾ (P53U)	B	■	–	–	–	■	191
5/3-way, exhausted, switching position 14 detenting (P53ED)	SA	–	–	■	–	■	170
5/3-way, exhausted, switching position 12 detenting (P53EP)	SE	–	–	■	–	■	170
5/3-way, port 2 pressurised, 4 exhausted, switching position 14 detenting (P53AD)	SB	■	–	–	–	■	172
5/3-way, port 4 pressurised, 2 exhausted, switching position 14 detenting (P53BD)	SD	–	–	■	–	■	172
2x3/2-way, single solenoid, closed (T32C)	K	–	–	■	■	–	190
2x3/2-way, single solenoid, open (T32U)	N	–	–	■	■	–	190
2x3/2-way, single solenoid, open/closed (T32H)	H	–	–	■	■	–	190
2x3/2-way, single solenoid, closed (T32N)	Q	–	■	–	■	–	190
2x3/2-way, single solenoid, open (T32F)	P	–	■	–	■	–	190
2x3/2-way, single solenoid, open/closed (T32W)	R	–	■	–	■	–	190
2x2/2-way, single solenoid, closed (T22C)	VC	–	–	■	■	–	190
2x2/2-way, single solenoid, closed (T22CV)	VV	■	–	–	■	–	190

- 1) If neither solenoid coil is energised, the valve is moved to its mid-position by spring force.
If both solenoid coils are energised at the same time, the valve remains in the previously assumed switching position.

Datasheet – Solenoid valve width 18 mm

Standard nominal flow rate of valve/valve terminal [l/min]						
Valve function (with valve code)	Terminal code	Flow rate				Valve on individual sub-base
		Valve	Valve on valve terminal			
			VTSA	VTSA-F	VTSA-F-CB	
5/2-way, double solenoid (B52)	J	750	550	700	700	600
5/2-way, double solenoid with dominant signal (D52)	D	750	550	700	700	600
5/2-way, single solenoid (M52-A)	M	750	550	700	700	600
5/2-way, single solenoid (M52-M)	O	750	550	700	700	600
5/3-way, closed (P53C)	G	700	450	650	650	550
5/3-way, exhausted (P53E)	E	700 ¹⁾ 330 ²⁾	450 ¹⁾ 330 ²⁾	480 ¹⁾ 330 ²⁾	480 ¹⁾ 330 ²⁾	500 ¹⁾ 330 ²⁾
5/3-way, pressurised (P53U)	B	700 ¹⁾ 330 ²⁾	450 ¹⁾ 330 ²⁾	480 ¹⁾ 330 ²⁾	480 ¹⁾ 330 ²⁾	500 ¹⁾ 330 ²⁾
5/3-way, exhausted, switching position 14 detenting (P53ED)	SA	–	380 ¹⁾ 310 ²⁾	430 ¹⁾ 360 ²⁾	430 ¹⁾ 360 ²⁾	390 ¹⁾ 310 ²⁾
5/3-way, exhausted, switching position 12 detenting (P53EP)	SE	–	380 ¹⁾ 300 ²⁾	460 ¹⁾ 350 ²⁾	460 ¹⁾ 350 ²⁾	390 ¹⁾ 320 ²⁾
5/3-way, port 2 pressurised, 4 exhausted, switching position 14 detenting (P53AD)	SB	–	380 ¹⁾ 350 ²⁾	440 ¹⁾ 400 ²⁾	440 ¹⁾ 400 ²⁾	380 ¹⁾ 360 ²⁾
5/3-way, port 4 pressurised, 2 exhausted, switching position 14 detenting (P53BD)	SD	–	370 ¹⁾ 340 ²⁾ 360 ³⁾ 360 ⁴⁾	430 ¹⁾ 360 ²⁾ 450 ³⁾ 450 ⁴⁾	430 ¹⁾ 360 ²⁾ 450 ³⁾ 450 ⁴⁾	400 ¹⁾ 350 ²⁾ 390 ³⁾ 380 ⁴⁾
2x3/2-way, single solenoid, closed (T32C)	K	600	400	550	550	500
2x3/2-way, single solenoid, open (T32U)	N	600	400	550	550	500
2x3/2-way, single solenoid, open/closed (T32H)	H	600	400	550	550	500
2x3/2-way, single solenoid, closed (T32N)	Q	600	400	550	550	500
2x3/2-way, single solenoid, open (T32F)	P	600	400	550	550	500
2x3/2-way, single solenoid, open/closed (T32W)	R	600	400	550	550	500
2x2/2-way, single solenoid, closed (T22C)	VC	700	500	650	650	500
2x2/2-way, single solenoid, closed (T22CV)	VV	700	500	650	650	500

- 1) Switching position
- 2) Mid-position
- 3) Switching position 4 → 5
- 4) Mid-position 2 → 3

 - **Note**

When using the solenoid valves VSVA-B-P53AD-...- or VSVA-B-P53BD-...- (terminal code SB or SD) for unobstructed exhausting (1→ 2 or 1→ 4) in the detenting or mid-position, the flow rate can reduce or drop to 0 l/min if the operating pressure is greater than 6 bar. This does not happen if a tube measuring at least 15 cm in length is used at port 2/4.

Datasheet – Solenoid valve width 18 mm

Valve switching times in [ms]				
Valve function (with valve code)	Terminal code	On	Off	Changeover
5/2-way, double solenoid (B52)	J	–	–	11
5/2-way, double solenoid with dominant signal (D52)	D	–	–	13
5/2-way, single solenoid (M52-A)	M	22	28	–
5/2-way, single solenoid (M52-M)	O	12	38	–
5/3-way, closed (P53C)	G	15	44	–
5/3-way, exhausted (P53E)	E	15	44	–
5/3-way, pressurised (P53U)	B	15	44	–
5/3-way, exhausted, switching position 14 detenting (P53ED)	SA	13 for control side 12 10 for control side 14	37 for control side 12	(24)
5/3-way, exhausted, switching position 12 detenting (P53EP)	SE	10 for control side 12 13 for control side 14	30 for control side 12	(23)
5/3-way, port 2 pressurised, 4 exhausted, switching position 14 detenting (P53AD)	SB	12 for control side 12 9 for control side 14	28 for control side 12	–
5/3-way, port 4 pressurised, 2 exhausted, switching position 14 detenting (P53BD)	SD	12 for control side 12 9 for control side 14	28 for control side 12	–
2x3/2-way, single solenoid, closed (T32C)	K	12	30	–
2x3/2-way, single solenoid, open (T32U)	N	12	30	–
2x3/2-way, single solenoid, open/closed (T32H)	H	12	30	–
2x3/2-way, single solenoid, closed (T32N)	Q	25	12	–
2x3/2-way, single solenoid, open (T32F)	P	25	12	–
2x3/2-way, single solenoid, open/closed (T32W)	R	25	12	–
2x2/2-way, single solenoid, closed (T22C)	VC	12	30	–
2x2/2-way, single solenoid, closed (T22CV)	VV	12	30	–

Characteristic coil data		
Valve function (with valve code)	Terminal code	Characteristic coil data at 24 V DC in [W]
5/2-way, double solenoid (B52)	J	1.6
5/2-way, double solenoid with dominant signal (D52)	D	1.3
5/2-way, single solenoid (M52-A)	M	1.6
5/2-way, single solenoid (M52-M)	O	1.6
5/3-way, closed (P53C)	G	1.6
5/3-way, exhausted (P53E)	E	1.6
5/3-way, pressurised (P53U)	B	1.6
5/3-way, exhausted, switching position 14 detenting (P53ED)	SA	1.6
5/3-way, exhausted, switching position 12 detenting (P53EP)	SE	1.6
5/3-way, port 2 pressurised, 4 exhausted, switching position 14 detenting (P53AD)	SB	1.6
5/3-way, port 4 pressurised, 2 exhausted, switching position 14 detenting (P53BD)	SD	1.6
2x3/2-way, single solenoid, closed (T32C)	K	1.3
2x3/2-way, single solenoid, open (T32U)	N	1.3
2x3/2-way, single solenoid, open/closed (T32H)	H	1.3
2x3/2-way, single solenoid, closed (T32N)	Q	1.3
2x3/2-way, single solenoid, open (T32F)	P	1.3
2x3/2-way, single solenoid, open/closed (T32W)	R	1.3
2x2/2-way, single solenoid, closed (T22C)	VC	1.3
2x2/2-way, single solenoid, closed (T22CV)	VV	1.3

Materials	
Housing	Die-cast aluminium, PA
Seals	FPM, NBR, HNBR
Screws	Galvanised steel
Note on materials	RoHS-compliant

Ordering data – Solenoid valve 24 V DC

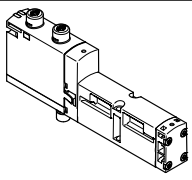
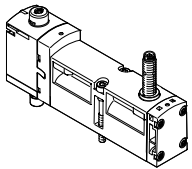
Ordering data – Solenoid valve VSVA, MO non-detenting/detenting (D)						
	Terminal code	Valve function	Valve code	Width	Part no.	Type
Solenoid valves, 24 V DC						
	VC	2x 2/2-way valve, single solenoid, normally closed, pneumatic spring return	T22C	18 mm	561155	VSVA-B-T22C-AZD-A2-1T1L
	VV	2x 2/2-way valve, single solenoid, normally closed, pneumatic spring return, vacuum operation possible at 3 and 5	T22CV	18 mm	561159	VSVA-B-T22CV-AZD-A2-1T1L
	N	2x 3/2-way valve, single solenoid, normally open	T32U	18 mm	539178	VSVA-B-T32U-AZD-A2-1T1L
	K	2x 3/2-way valve, single solenoid, normally closed	T32C	18 mm	539176	VSVA-B-T32C-AZD-A2-1T1L
	H	2x 3/2-way valve, single solenoid, 1x normally open, 1x normally closed	T32H	18 mm	539180	VSVA-B-T32H-AZD-A2-1T1L
	P	2x 3/2-way valve, single solenoid, reverse operation, normally open	T32F	18 mm	539179	VSVA-B-T32F-AZD-A2-1T1L
	Q	2x 3/2-way valve, single solenoid, reverse operation, normally closed	T32N	18 mm	539177	VSVA-B-T32N-AZD-A2-1T1L
	R	2x 3/2-way valve, single solenoid, reverse operation, 1x normally open, 1x normally closed	T32W	18 mm	539181	VSVA-B-T32W-AZD-A2-1T1L
	M	5/2-way valve, single solenoid, pneumatic spring return	M52-A	18 mm	539184	VSVA-B-M52-AZD-A2-1T1L
	O	5/2-way valve, single solenoid, reset via mechanical spring	M52-M	18 mm	539185	VSVA-B-M52-MZD-A2-1T1L
	J	5/2-way valve, double solenoid	B52	18 mm	539182	VSVA-B-B52-ZD-A2-1T1L
	D	5/2-way valve, double solenoid, with dominant signal	D52	18 mm	539183	VSVA-B-D52-ZD-A2-1T1L
	B	5/3-way solenoid valve, Mid-position pressurised	P53U	18 mm	539186	VSVA-B-P53U-ZD-A2-1T1L
	G	5/3-way solenoid valve, mid-position closed	P53C	18 mm	539188	VSVA-B-P53C-ZD-A2-1T1L
	E	5/3-way solenoid valve, Mid-position exhausted	P53E	18 mm	539187	VSVA-B-P53E-ZD-A2-1T1L
	SA	5/3-way solenoid valve, mid-position exhausted, switching position 14 detenting, mechanical spring return	P53ED	18 mm	8031814	VSVA-B-P53ED-ZD-A2-1T1L
	SE	5/3-way solenoid valve, mid-position exhausted, switching position 12 detenting, mechanical spring return	P53EP	18 mm	8031818	VSVA-B-P53EP-ZD-A2-1T1L
	SB	5/3-way solenoid valve, mid-position 1x exhausted from 4 to 5, 1x pressurised from 1 to 2, switching position 14 detenting, same function in both switching positions: pressurised from 1 to 4 and exhausted from 2 to 3, reset via mechanical spring	P53AD	18 mm	8031815	VSVA-B-P53AD-ZD-A2-1T1L
	SD	5/3-way solenoid valve, mid-position 1x exhausted from 2 to 3, 1x pressurised from 1 to 4, switching position 14 detenting, same function in both switching positions: pressurised from 1 to 2 and exhausted from 4 to 5, reset via mechanical spring	P53BD	18 mm	8031817	VSVA-B-P53BD-ZD-A2-1T1L
	SS	5/2-way valve, single solenoid, mechanical spring return, inductive sensor with PNP output with 0.5 m connecting cable and 4-pin sensor push-in connector M12x1	M52-M	18 mm	573201	VSVA-B-M52-MZD-A2-1T1L-APX-0.5
	SO	5/2-way valve, single solenoid, mechanical spring return, inductive sensor with PNP output and 3-pin sensor push-in connector M8x1	M52-M	18 mm	573202	VSVA-B-M52-MZD-A2-1T1L-APP

Ordering data – Solenoid valve 24 V DC

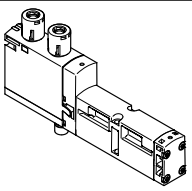
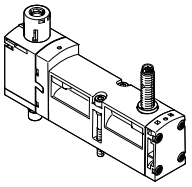
Ordering data – Solenoid valve VSVA with cover cap for MO non-detenting/heavy duty, detenting via accessory (TR)						
	Terminal code	Valve function	Valve code	Width	Part no.	Type
Solenoid valves, 24 V DC						
	VC	2x 2/2-way valve, single solenoid, normally closed, pneumatic spring return	T22C	18 mm	8033457	VSVA-B-T22C-AZTR-A2-1T1L
	VV	2x 2/2-way valve, single solenoid, normally closed, pneumatic spring return, vacuum operation possible at 3 and 5	T22CV	18 mm	8033458	VSVA-B-T22CV-AZTR-A2-1T1L
	N	2x 3/2-way valve, single solenoid, normally open	T32U	18 mm	8033446	VSVA-B-T32U-AZTR-A2-1T1L
	K	2x 3/2-way valve, single solenoid, normally closed	T32C	18 mm	8033444	VSVA-B-T32C-AZTR-A2-1T1L
	H	2x 3/2-way valve, single solenoid, 1x normally open, 1x normally closed	T32H	18 mm	8033448	VSVA-B-T32H-AZTR-A2-1T1L
	P	2x 3/2-way valve, single solenoid, reverse operation, normally open	T32F	18 mm	8033447	VSVA-B-T32F-AZTR-A2-1T1L
	Q	2x 3/2-way valve, single solenoid, reverse operation, normally closed	T32N	18 mm	8033445	VSVA-B-T32N-AZTR-A2-1T1L
	R	2x 3/2-way valve, single solenoid, reverse operation, 1x normally open, 1x normally closed	T32W	18 mm	8033449	VSVA-B-T32W-AZTR-A2-1T1L
	M	5/2-way valve, single solenoid, pneumatic spring return	M52-A	18 mm	8033452	VSVA-B-M52-AZTR-A2-1T1L
	O	5/2-way valve, single solenoid, reset via mechanical spring	M52-M	18 mm	8033453	VSVA-B-M52-MZTR-A2-1T1L
	J	5/2-way valve, double solenoid	B52	18 mm	8033450	VSVA-B-B52-ZTR-A2-1T1L
	D	5/2-way valve, double solenoid, with dominant signal	D52	18 mm	8033451	VSVA-B-D52-ZTR-A2-1T1L
	B	5/3-way solenoid valve, Mid-position pressurised	P53U	18 mm	8033454	VSVA-B-P53U-ZTR-A2-1T1L
	G	5/3-way solenoid valve, mid-position closed	P53C	18 mm	8033456	VSVA-B-P53C-ZTR-A2-1T1L
	E	5/3-way solenoid valve, Mid-position exhausted	P53E	18 mm	8033455	VSVA-B-P53E-ZTR-A2-1T1L
		SA	5/3-way solenoid valve, mid-position exhausted, switching position 14 detenting, mechanical spring return	P53ED	18 mm	8039181
SE		5/3-way solenoid valve, mid-position exhausted, switching position 12 detenting, mechanical spring return	P53EP	18 mm	8039190	VSVA-B-P53EP-ZTR-A2-1T1L
SB		5/3-way solenoid valve, mid-position 1x exhausted from 4 to 5, 1x pressurised from 1 to 2, switching position 14 detenting, same function in both switching positions: pressurised from 1 to 4 and exhausted from 2 to 3, reset via mechanical spring	P53AD	18 mm	8039184	VSVA-B-P53AD-ZTR-A2-1T1L
SD		5/3-way solenoid valve, mid-position 1x exhausted from 2 to 3, 1x pressurised from 1 to 4, switching position 14 detenting, same function in both switching positions: pressurised from 1 to 2 and exhausted from 4 to 5, reset via mechanical spring	P53BD	18 mm	8040110	VSVA-B-P53BD-ZTR-A2-1T1L
SS		5/2-way valve, single solenoid, mechanical spring return, inductive sensor with PNP output with 0.5 m connecting cable and 4-pin sensor push-in connector M12x1	M52-M	18 mm	8033459	VSVA-B-M52-MZTR-A2-1T1L-APX-0.5
SO		5/2-way valve, single solenoid, mechanical spring return, inductive sensor with PNP output and 3-pin sensor push-in connector M8x1	M52-M	18 mm	8033460	VSVA-B-M52-MZTR-A2-1T1L-APP

Ordering data – Solenoid valve 24 V DC

Ordering data – Solenoid valve VSVA with cover cap for MO, non-detenting (H)						
	Terminal code	Valve function	Valve code	Width	Part no.	Type
Solenoid valves, 24 V DC						
	VC	2x 2/2-way valve, single solenoid, normally closed, pneumatic spring return	T22C	18 mm	8033475	VSVA-B-T22C-AZH-A2-1T1L
	VV	2x 2/2-way valve, single solenoid, normally closed, pneumatic spring return, vacuum operation possible at 3 and 5	T22CV	18 mm	8033476	VSVA-B-T22CV-AZH-A2-1T1L
	N	2x 3/2-way valve, single solenoid, normally open	T32U	18 mm	8033464	VSVA-B-T32U-AZH-A2-1T1L
	K	2x 3/2-way valve, single solenoid, normally closed	T32C	18 mm	8033462	VSVA-B-T32C-AZH-A2-1T1L
	H	2x 3/2-way valve, single solenoid, 1x normally open, 1x normally closed	T32H	18 mm	8033466	VSVA-B-T32H-AZH-A2-1T1L
	P	2x 3/2-way valve, single solenoid, reverse operation, normally open	T32F	18 mm	8033465	VSVA-B-T32F-AZH-A2-1T1L
	Q	2x 3/2-way valve, single solenoid, reverse operation, normally closed	T32N	18 mm	8033463	VSVA-B-T32N-AZH-A2-1T1L
	R	2x 3/2-way valve, single solenoid, reverse operation, 1x normally open, 1x normally closed	T32W	18 mm	8033467	VSVA-B-T32W-AZH-A2-1T1L
	M	5/2-way valve, single solenoid, pneumatic spring return	M52-A	18 mm	8033470	VSVA-B-M52-AZH-A2-1T1L
	O	5/2-way valve, single solenoid, reset via mechanical spring	M52-M	18 mm	8033471	VSVA-B-M52-MZH-A2-1T1L
	J	5/2-way valve, double solenoid	B52	18 mm	8033468	VSVA-B-B52-ZH-A2-1T1L
	D	5/2-way valve, double solenoid, with dominant signal	D52	18 mm	8033469	VSVA-B-D52-ZH-A2-1T1L
	B	5/3-way solenoid valve, Mid-position pressurised	P53U	18 mm	8033472	VSVA-B-P53U-ZH-A2-1T1L
	G	5/3-way solenoid valve, mid-position closed	P53C	18 mm	8033474	VSVA-B-P53C-ZH-A2-1T1L
	E	5/3-way solenoid valve, Mid-position exhausted	P53E	18 mm	8033473	VSVA-B-P53E-ZH-A2-1T1L
		SA	5/3-way solenoid valve, mid-position exhausted, switching position 14 detenting, mechanical spring return	P53ED	18 mm	8039182
SE		5/3-way solenoid valve, mid-position exhausted, switching position 12 detenting, mechanical spring return	P53EP	18 mm	8039191	VSVA-B-P53EP-ZH-A2-1T1L
SB		5/3-way solenoid valve, mid-position 1x exhausted from 4 to 5, 1x pressurised from 1 to 2, switching position 14 detenting, same function in both switching positions: pressurised from 1 to 4 and exhausted from 2 to 3, reset via mechanical spring	P53AD	18 mm	8039185	VSVA-B-P53AD-ZH-A2-1T1L
SD		5/3-way solenoid valve, mid-position 1x exhausted from 2 to 3, 1x pressurised from 1 to 4, switching position 14 detenting, same function in both switching positions: pressurised from 1 to 2 and exhausted from 4 to 5, reset via mechanical spring	P53BD	18 mm	8040111	VSVA-B-P53BD-ZH-A2-1T1L
SS		5/2-way valve, single solenoid, mechanical spring return, inductive sensor with PNP output with 0.5 m connecting cable and 4-pin sensor push-in connector M12x1	M52-M	18 mm	8033477	VSVA-B-M52-MZH-A2-1T1L-APX-0.5
SO		5/2-way valve, single solenoid, mechanical spring return, inductive sensor with PNP output and 3-pin sensor push-in connector M8x1	M52-M	18 mm	8033478	VSVA-B-M52-MZH-A2-1T1L-APP

Ordering data – Solenoid valve 24 V DC

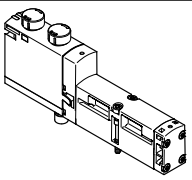
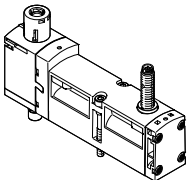
Ordering data – Solenoid valve VSVA with cover cap for MO, concealed						
	Terminal code	Valve function	Valve code	Width	Part no.	Type
Solenoid valves, 24 V DC						
	VC	2x 2/2-way valve, single solenoid, normally closed, pneumatic spring return	T22C	18 mm	8033493	VSVA-B-T22C-AZ-A2-1T1L
	VV	2x 2/2-way valve, single solenoid, normally closed, pneumatic spring return, vacuum operation possible at 3 and 5	T22CV	18 mm	8033494	VSVA-B-T22CV-AZ-A2-1T1L
	N	2x 3/2-way valve, single solenoid, normally open	T32U	18 mm	8033482	VSVA-B-T32U-AZ-A2-1T1L
	K	2x 3/2-way valve, single solenoid, normally closed	T32C	18 mm	8033480	VSVA-B-T32C-AZ-A2-1T1L
	H	2x 3/2-way valve, single solenoid, 1x normally open, 1x normally closed	T32H	18 mm	8033484	VSVA-B-T32H-AZ-A2-1T1L
	P	2x 3/2-way valve, single solenoid, reverse operation, normally open	T32F	18 mm	8033483	VSVA-B-T32F-AZ-A2-1T1L
	Q	2x 3/2-way valve, single solenoid, reverse operation, normally closed	T32N	18 mm	8033481	VSVA-B-T32N-AZ-A2-1T1L
	R	2x 3/2-way valve, single solenoid, reverse operation, 1x normally open, 1x normally closed	T32W	18 mm	8033485	VSVA-B-T32W-AZ-A2-1T1L
	M	5/2-way valve, single solenoid, pneumatic spring return	M52-A	18 mm	8033488	VSVA-B-M52-AZ-A2-1T1L
	O	5/2-way valve, single solenoid, reset via mechanical spring	M52-M	18 mm	8033489	VSVA-B-M52-MZ-A2-1T1L
	J	5/2-way valve, double solenoid	B52	18 mm	8033486	VSVA-B-B52-Z-A2-1T1L
	D	5/2-way valve, double solenoid, with dominant signal	D52	18 mm	8033487	VSVA-B-D52-Z-A2-1T1L
	B	5/3-way solenoid valve, Mid-position pressurised	P53U	18 mm	8033490	VSVA-B-P53U-Z-A2-1T1L
	G	5/3-way solenoid valve, mid-position closed	P53C	18 mm	8033492	VSVA-B-P53C-Z-A2-1T1L
	E	5/3-way solenoid valve, Mid-position exhausted	P53E	18 mm	8033491	VSVA-B-P53E-Z-A2-1T1L
		SA	5/3-way solenoid valve, mid-position exhausted, switching position 14 detenting, mechanical spring return	P53ED	18 mm	8039183
SE		5/3-way solenoid valve, mid-position exhausted, switching position 12 detenting, mechanical spring return	P53EP	18 mm	8039192	VSVA-B-P53EP-Z-A2-1T1L
SB		5/3-way solenoid valve, mid-position 1x exhausted from 4 to 5, 1x pressurised from 1 to 2, switching position 14 detenting, same function in both switching positions: pressurised from 1 to 4 and exhausted from 2 to 3, reset via mechanical spring	P53AD	18 mm	8039186	VSVA-B-P53AD-Z-A2-1T1L
SD		5/3-way solenoid valve, mid-position 1x exhausted from 2 to 3, 1x pressurised from 1 to 4, switching position 14 detenting, same function in both switching positions: pressurised from 1 to 2 and exhausted from 4 to 5, reset via mechanical spring	P53BD	18 mm	8040112	VSVA-B-P53BD-Z-A2-1T1L
SS		5/2-way valve, single solenoid, mechanical spring return, inductive sensor with PNP output with 0.5 m connecting cable and 4-pin sensor push-in connector M12x1	M52-M	18 mm	8033495	VSVA-B-M52-MZ-A2-1T1L-APX-0.5
SO		5/2-way valve, single solenoid, mechanical spring return, inductive sensor with PNP output and 3-pin sensor push-in connector M8x1	M52-M	18 mm	8033496	VSVA-B-M52-MZ-A2-1T1L-APP

Ordering data – Solenoid valve 24 V DC – for VTSA-F-CB

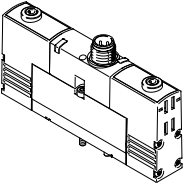
Ordering data – Solenoid valve VSVA with central plug, 3-pin, M12x1, round design						
	Terminal code	Valve function	Valve code	Width	Part no.	Type
Solenoid valves, 24 V DC						
	QN	2x 3/2-way valve, single solenoid, normally open	T32U	18 mm	546775	VSVA-B-T32U-AZH-A2-1R5L
	QK	2x 3/2-way valve, single solenoid, normally closed	T32C	18 mm	546774	VSVA-B-T32C-AZH-A2-1R5L
	QH	2x 3/2-way valve, single solenoid, 1x normally open, 1x normally closed	T32H	18 mm	546776	VSVA-B-T32H-AZH-A2-1R5L
	QM	5/2-way valve, single solenoid, pneumatic spring return	M52-A	18 mm	546777	VSVA-B-M52-AZH-A2-1R5L
	QO	5/2-way valve, single solenoid, reset via mechanical spring	M52-M	18 mm	546778	VSVA-B-M52-MZH-A2-1R5L
	QJ	5/2-way valve, double solenoid	B52	18 mm	546779	VSVA-B-B52-ZH-A2-1R5L
	QD	5/2-way valve, double solenoid, with dominant signal	D52	18 mm	546780	VSVA-B-D52-ZH-A2-1R5L
	QB	5/3-way solenoid valve, Mid-position pressurised	P53U	18 mm	546783	VSVA-B-P53U-ZH-A2-1R5L
	QG	5/3-way solenoid valve, mid-position closed	P53C	18 mm	546781	VSVA-B-P53C-ZH-A2-1R5L
	QE	5/3-way solenoid valve, Mid-position exhausted	P53E	18 mm	546782	VSVA-B-P53E-ZH-A2-1R5L

 **Note**

Additional information about solenoid valves with central plug can be found in the existing catalogue documentation at:
www.festo.com/catalogue/... → Support Portal:
 Standards-based valve VSVA to ISO 15407-1 and ISO 5599-1 with M8 or M12 central plug

Datasheet – Solenoid valve width 26 mm

-  Valve width
to ISO 15407-2
26 mm

-  Voltage
24 V DC

-  Flow rate
Valve width 26 mm:
VTSA up to 1100 l/min
VTSA-F up to 1350 l/min
VTSA-F-CB up to 1350 l/min



Safety characteristics for valve

Conforms to	EN 13849-1/2
CE marking (see declaration of conformity)	Direct voltage 24 V DC To EU EMC Directive ¹⁾ (solenoid valves with sensor only)
Shock resistance	Shock test with severity level 2, to EN 60068-2-27
Vibration resistance	Transport application test with severity level 2, to EN 60068-2-6

1) For information about the area of use, see the EC declaration of conformity at: www.festo.com/catalogue/... → Support/Downloads.

If the devices are subject to usage restrictions in residential, commercial or light-industrial environments, further measures for the reduction of the emitted interference may be necessary.

Safety characteristics for valve, 24 V DC

Valve function (with valve code)	Terminal code	Test pulses	
		Max. positive test pulse with logic 0 [μs]	Max. negative test pulse with logic 1 [μs]
5/2-way, double solenoid (B52)	J	1200	1100
5/2-way, double solenoid with dominant signal (D52)	D	1200	1100
5/2-way, single solenoid (M52-A)	M	1200	1100
5/2-way, single solenoid (M52-M)	O	1200	1100
5/3-way, closed (P53C)	G	1200	1100
5/3-way, exhausted (P53E)	E	1200	1100
5/3-way, pressurised (P53U)	B	1200	1100
5/3-way, exhausted, switching position 14 detenting (P53ED)	SA	1200	1100
5/3-way, exhausted, switching position 12 detenting (P53EP)	SE	1200	1100
5/3-way, port 2 pressurised, 4 exhausted, switching position 14 detenting (P53AD)	SB	1200	1100
5/3-way, port 4 pressurised, 2 exhausted, switching position 14 detenting (P53BD)	SD	1200	1100
2x3/2-way, single solenoid, closed (T32C)	K	1500	1200
2x3/2-way, single solenoid, open (T32U)	N	1500	1200
2x3/2-way, single solenoid, open/closed (T32H)	H	1500	1200
2x3/2-way, single solenoid, closed (T32N)	Q	1500	1200
2x3/2-way, single solenoid, open (T32F)	P	1500	1200
2x3/2-way, single solenoid, open/closed (T32W)	R	1500	1200
2x2/2-way, single solenoid, closed (T22C)	VC	1500	1200
2x2/2-way, single solenoid, closed (T22CV)	VV	1500	1200

Datasheet – Solenoid valve width 26 mm

Datasheet for valve							
Valve function (with valve code)	Terminal code	Flow direction			Reset method		Weight [g]
		Any	Reversible only	Not reversible	Pneumatic spring	Mechanical spring	
5/2-way, double solenoid (B52)	J	■	–	–	–	–	276
5/2-way, double solenoid with dominant signal (D52)	D	■	–	–	–	–	276
5/2-way, single solenoid (M52-A)	M	■	–	–	■	–	293
5/2-way, single solenoid (M52-M)	O	■	–	–	–	■	293
5/3-way, closed ¹⁾ (P53C)	G	■	–	–	–	■	320
5/3-way, exhausted ¹⁾ (P53E)	E	■	–	–	–	■	320
5/3-way, pressurised ¹⁾ (P53U)	B	■	–	–	–	■	320
5/3-way, exhausted, switching position 14 detenting (P53ED)	SA	–	–	■	–	■	291
5/3-way, exhausted, switching position 12 detenting (P53EP)	SE	–	–	■	–	■	291
5/3-way, port 2 pressurised, 4 exhausted, switching position 14 detenting (P53AD)	SB	■	–	–	–	■	301
5/3-way, port 4 pressurised, 2 exhausted, switching position 14 detenting (P53BD)	SD	–	–	■	–	■	301
2x3/2-way, single solenoid, closed (T32C)	K	–	–	■	■	–	335
2x3/2-way, single solenoid, open (T32U)	N	–	–	■	■	–	335
2x3/2-way, single solenoid, open/closed (T32H)	H	–	–	■	■	–	335
2x3/2-way, single solenoid, closed (T32N)	Q	–	■	–	■	–	335
2x3/2-way, single solenoid, open (T32F)	P	–	■	–	■	–	335
2x3/2-way, single solenoid, open/closed (T32W)	R	–	■	–	■	–	335
2x2/2-way, single solenoid, closed (T22C)	VC	–	–	■	■	–	335
2x2/2-way, single solenoid, closed (T22CV)	VV	■	–	–	■	–	335

- 1) If neither solenoid coil is energised, the valve is moved to its mid-position by spring force.
If both solenoid coils are energised at the same time, the valve remains in the previously assumed switching position.

Datasheet – Solenoid valve width 26 mm

Standard nominal flow rate of valve/valve terminal [l/min] Valve function (with valve code)	Terminal code	Flow rate				Valve on individual sub-base
		Valve	Valve on valve terminal			
			VTSA	VTSA-F	VTSA-F-CB	
5/2-way, double solenoid (B52)	J	1400	1100	1350	1350	1200
5/2-way, double solenoid with dominant signal (D52)	D	1400	1100	1350	1350	1200
5/2-way, single solenoid (M52-A)	M	1400	1100	1350	1350	1200
5/2-way, single solenoid (M52-M)	O	1400	1100	1350	1350	1200
5/3-way, closed (P53C)	G	1400 ¹⁾ 700 ²⁾	1000 ¹⁾ 700 ²⁾	1350 ¹⁾ 700 ²⁾	1350 ¹⁾ 700 ²⁾	1200 ¹⁾ 700 ²⁾
5/3-way, exhausted (P53E)	E	1400 ¹⁾ 700 ²⁾	1000 ¹⁾ 700 ²⁾	1350 ¹⁾ 700 ²⁾	1350 ¹⁾ 700 ²⁾	1200 ¹⁾ 700 ²⁾
5/3-way, pressurised (P53U)	B	1400 ¹⁾ 700 ²⁾	1000 ¹⁾ 700 ²⁾	1350 ¹⁾ 700 ²⁾	1350 ¹⁾ 700 ²⁾	1200 ¹⁾ 700 ²⁾
5/3-way, exhausted, switching position 14 detenting (P53ED)	SA	1400 ¹⁾ 700 ²⁾	1000 ¹⁾ 700 ²⁾	1350 ¹⁾ 700 ²⁾	1350 ¹⁾ 700 ²⁾	1200 ¹⁾ 700 ²⁾
5/3-way, exhausted, switching position 12 detenting (P53EP)	SE	1400 ¹⁾ 700 ²⁾	1000 ¹⁾ 700 ²⁾	1350 ¹⁾ 700 ²⁾	1350 ¹⁾ 700 ²⁾	1200 ¹⁾ 700 ²⁾
5/3-way, port 2 pressurised, 4 exhausted, switching position 14 detenting (P53AD)	SB	700 ¹⁾ 700 ²⁾	700 ¹⁾ 700 ²⁾	700 ¹⁾ 700 ²⁾	700 ¹⁾ 700 ²⁾	700 ¹⁾ 700 ²⁾
5/3-way, port 4 pressurised, 2 exhausted, switching position 14 detenting (P53BD)	SD	–	850 ¹⁾ 820 ²⁾	950 ¹⁾ 860 ²⁾	950 ¹⁾ 860 ²⁾	900 ¹⁾ 840 ²⁾
2x3/2-way, single solenoid, closed (T32C)	K	1250	900	1150	1150	1100
2x3/2-way, single solenoid, open (T32U)	N	1250	900	1150	1150	1100
2x3/2-way, single solenoid, open/closed (T32H)	H	1250	900	1150	1150	1100
2x3/2-way, single solenoid, closed (T32N)	Q	1250	900	1150	1150	1100
2x3/2-way, single solenoid, open (T32F)	P	1250	900	1150	1150	1100
2x3/2-way, single solenoid, open/closed (T32W)	R	1250	900	1150	1150	1100
2x2/2-way, single solenoid, closed (T22C)	VC	1350	1000	1300	1300	1100
2x2/2-way, single solenoid, closed (T22CV)	VV	1350	1000	1300	1300	1100

1) Switching position

2) Mid-position

 **Note**

The solenoid valves VSVA-B-P53BD...-A1-1T1L (terminal code SD) can be operated without restrictions at an operating pressure of less than 6 bar. At an operating pressure of more than 6 bar, the actual flow rate must not exceed 1900 l/min (e.g. 10-->2 bar) or these solenoid valves may switch unintentionally (to the mid-position or switching position 14).

At pressures above 6 bar, it is possible to prevent the flow rate from becoming too high by using a flow control valve or orifice (e.g. a reducing nipple on port 2 or 4 from G1/4 to G1/8).

Datasheet – Solenoid valve width 26 mm

Valve switching times in [ms]				
Valve function (with valve code)	Terminal code	On	Off	Changeover
5/2-way, double solenoid (B52)	J	–	–	18
5/2-way, double solenoid with dominant signal (D52)	D	–	–	21
5/2-way, single solenoid (M52-A)	M	25	45	–
5/2-way, single solenoid (M52-M)	O	20	65	–
5/3-way, closed (P53C)	G	22	65	–
5/3-way, exhausted (P53E)	E	22	65	–
5/3-way, pressurised (P53U)	B	22	65	–
5/3-way, exhausted, switching position 14 detenting (P53ED)	SA	22 for control side 12 9 for control side 14	49 for control side 12	33
5/3-way, exhausted, switching position 12 detenting (P53EP)	SE	10 for control side 12 22 for control side 14	50 for control side 14	40
5/3-way, port 2 pressurised, 4 exhausted, switching position 14 detenting (P53AD)	SB	19 for control side 12 9 for control side 14	36 for control side 12	32
5/3-way, port 4 pressurised, 2 exhausted, switching position 14 detenting (P53BD)	SD	16 for control side 12 9 for control side 14	26 for control side 12 36 for control side 14	–
2x3/2-way, single solenoid, closed (T32C)	K	20	38	–
2x3/2-way, single solenoid, open (T32U)	N	20	38	–
2x3/2-way, single solenoid, open/closed (T32H)	H	20	38	–
2x3/2-way, single solenoid, closed (T32N)	Q	32	30	–
2x3/2-way, single solenoid, open (T32F)	P	32	30	–
2x3/2-way, single solenoid, open/closed (T32W)	R	32	30	–
2x2/2-way, single solenoid, closed (T22C)	VC	20	38	–
2x2/2-way, single solenoid, closed (T22CV)	VV	20	38	–

Characteristic coil data		
Valve function (with valve code)	Terminal code	Characteristic coil data at 24 V DC in [W]
5/2-way, double solenoid (B52)	J	1.6
5/2-way, double solenoid with dominant signal (D52)	D	1.3
5/2-way, single solenoid (M52-A)	M	1.6
5/2-way, single solenoid (M52-M)	O	1.6
5/3-way, closed (P53C)	G	1.6
5/3-way, exhausted (P53E)	E	1.6
5/3-way, pressurised (P53U)	B	1.6
5/3-way, exhausted, switching position 14 detenting (P53ED)	SA	1.6
5/3-way, exhausted, switching position 12 detenting (P53EP)	SE	1.6
5/3-way, port 2 pressurised, 4 exhausted, switching position 14 detenting (P53AD)	SB	1.6
5/3-way, port 4 pressurised, 2 exhausted, switching position 14 detenting (P53BD)	SD	1.6
2x3/2-way, single solenoid, closed (T32C)	K	1.3
2x3/2-way, single solenoid, open (T32U)	N	1.3
2x3/2-way, single solenoid, open/closed (T32H)	H	1.3
2x3/2-way, single solenoid, closed (T32N)	Q	1.3
2x3/2-way, single solenoid, open (T32F)	P	1.3
2x3/2-way, single solenoid, open/closed (T32W)	R	1.3
2x2/2-way, single solenoid, closed (T22C)	VC	1.3
2x2/2-way, single solenoid, closed (T22CV)	VV	1.3

Materials	
Housing	Die-cast aluminium, PA
Seals	FPM, NBR, HNBR
Screws	Galvanised steel
Note on materials	RoHS-compliant

Ordering data – Solenoid valve 24 V DC

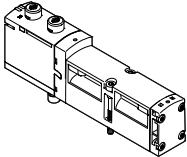
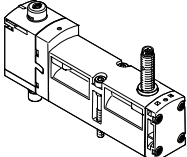
Ordering data – Solenoid valve VSVA, MO non-detenting/detenting (D)						
	Terminal code	Valve function	Valve code	Width	Part no.	Type
Solenoid valves, 24 V DC						
	VC	2x 2/2-way valve, single solenoid, normally closed, pneumatic spring return	T22C	26 mm	561149	VSVA-B-T22C-AZD-A1-1T1L
	VV	2x 2/2-way valve, single solenoid, normally closed, pneumatic spring return, vacuum operation possible at 3 and 5	T22CV	26 mm	561153	VSVA-B-T22CV-AZD-A1-1T1L
	N	2x 3/2-way valve, single solenoid, normally open	T32U	26 mm	539152	VSVA-B-T32U-AZD-A1-1T1L
	K	2x 3/2-way valve, single solenoid, normally closed	T32C	26 mm	539150	VSVA-B-T32C-AZD-A1-1T1L
	H	2x 3/2-way valve, single solenoid, 1x normally open, 1x normally closed	T32H	26 mm	539154	VSVA-B-T32H-AZD-A1-1T1L
	P	2x 3/2-way valve, single solenoid, reverse operation, normally open	T32F	26 mm	539153	VSVA-B-T32F-AZD-A1-1T1L
	Q	2x 3/2-way valve, single solenoid, reverse operation, normally closed	T32N	26 mm	539151	VSVA-B-T32N-AZD-A1-1T1L
	R	2x 3/2-way valve, single solenoid, reverse operation, 1x normally open, 1x normally closed	T32W	26 mm	539155	VSVA-B-T32W-AZD-A1-1T1L
	M	5/2-way valve, single solenoid, pneumatic spring return	M52-A	26 mm	539158	VSVA-B-M52-AZD-A1-1T1L
	O	5/2-way valve, single solenoid, reset via mechanical spring	M52-M	26 mm	539159	VSVA-B-M52-MZD-A1-1T1L
	J	5/2-way valve, double solenoid	B52	26 mm	539156	VSVA-B-B52-ZD-A1-1T1L
	D	5/2-way valve, double solenoid, with dominant signal	D52	26 mm	539157	VSVA-B-D52-ZD-A1-1T1L
	B	5/3-way solenoid valve, Mid-position pressurised	P53U	26 mm	539160	VSVA-B-P53U-ZD-A1-1T1L
	G	5/3-way solenoid valve, mid-position closed	P53C	26 mm	539162	VSVA-B-P53C-ZD-A1-1T1L
	E	5/3-way solenoid valve, Mid-position exhausted	P53E	26 mm	539161	VSVA-B-P53E-ZD-A1-1T1L
	SA	5/3-way solenoid valve, mid-position exhausted, switching position 14 detenting, mechanical spring return	P53ED	26 mm	560727	VSVA-B-P53ED-ZD-A1-1T1L
	SE	5/3-way solenoid valve, mid-position exhausted, switching position 12 detenting, mechanical spring return	P53EP	26 mm	8026638	VSVA-B-P53EP-ZD-A1-1T1L
SB	5/3-way solenoid valve, mid-position 1x exhausted from 4 to 5, 1x pressurised from 1 to 2, switching position 14 detenting, same function in both switching positions: pressurised from 1 to 4 and exhausted from 2 to 3, reset via mechanical spring	P53AD	26 mm	560728	VSVA-B-P53AD-ZD-A1-1T1L	
SD	5/3-way solenoid valve, mid-position 1x exhausted from 2 to 3, 1x pressurised from 1 to 4, switching position 14 detenting, same function in both switching positions: pressurised from 1 to 2 and exhausted from 4 to 5, reset via mechanical spring	P53BD	26 mm	8031816	VSVA-B-P53BD-ZD-A1-1T1L	
	SS	5/2-way valve, single solenoid, mechanical spring return, inductive sensor with PNP output with 0.5 m connecting cable and 4-pin sensor push-in connector M12x1	M52-M	26 mm	570850	VSVA-B-M52-MZD-A1-1T1L-APX-0.5
	SO	5/2-way valve, single solenoid, mechanical spring return, inductive sensor with PNP output and 3-pin sensor push-in connector M8x1	M52-M	26 mm	560724	VSVA-B-M52-MZD-A1-1T1L-APP

Ordering data – Solenoid valve 24 V DC

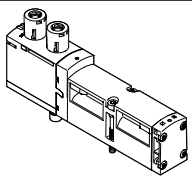
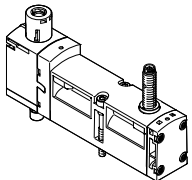
Ordering data – Solenoid valve VSVA with cover cap for MO non-detenting/heavy duty, detenting via accessory (TR)						
	Terminal code	Valve function	Valve code	Width	Part no.	Type
Solenoid valves, 24 V DC						
	VC	2x 2/2-way valve, single solenoid, normally closed, pneumatic spring return	T22C	26 mm	8033032	VSVA-B-T22C-AZTR-A1-1T1L
	VV	2x 2/2-way valve, single solenoid, normally closed, pneumatic spring return, vacuum operation possible at 3 and 5	T22CV	26 mm	8033033	VSVA-B-T22CV-AZTR-A1-1T1L
	N	2x 3/2-way valve, single solenoid, normally open	T32U	26 mm	8033015	VSVA-B-T32U-AZTR-A1-1T1L
	K	2x 3/2-way valve, single solenoid, normally closed	T32C	26 mm	8033013	VSVA-B-T32C-AZTR-A1-1T1L
	H	2x 3/2-way valve, single solenoid, 1x normally open, 1x normally closed	T32H	26 mm	8033017	VSVA-B-T32H-AZTR-A1-1T1L
	P	2x 3/2-way valve, single solenoid, reverse operation, normally open	T32F	26 mm	8033016	VSVA-B-T32F-AZTR-A1-1T1L
	Q	2x 3/2-way valve, single solenoid, reverse operation, normally closed	T32N	26 mm	8033014	VSVA-B-T32N-AZTR-A1-1T1L
	R	2x 3/2-way valve, single solenoid, reverse operation, 1x normally open, 1x normally closed	T32W	26 mm	8033018	VSVA-B-T32W-AZTR-A1-1T1L
	M	5/2-way valve, single solenoid, pneumatic spring return	M52-A	26 mm	8033021	VSVA-B-M52-AZTR-A1-1T1L
	O	5/2-way valve, single solenoid, reset via mechanical spring	M52-M	26 mm	8033022	VSVA-B-M52-MZTR-A1-1T1L
	J	5/2-way valve, double solenoid	B52	26 mm	8033019	VSVA-B-B52-ZTR-A1-1T1L
	D	5/2-way valve, double solenoid, with dominant signal	D52	26 mm	8033020	VSVA-B-D52-ZTR-A1-1T1L
	B	5/3-way solenoid valve, Mid-position pressurised	P53U	26 mm	8033023	VSVA-B-P53U-ZTR-A1-1T1L
	G	5/3-way solenoid valve, mid-position closed	P53C	26 mm	8033025	VSVA-B-P53C-ZTR-A1-1T1L
	E	5/3-way solenoid valve, Mid-position exhausted	P53E	26 mm	8033024	VSVA-B-P53E-ZTR-A1-1T1L
	SA	5/3-way solenoid valve, mid-position exhausted, switching position 14 detenting, mechanical spring return	P53ED	26 mm	8033028	VSVA-B-P53ED-ZTR-A1-1T1L
	SE	5/3-way solenoid valve, mid-position exhausted, switching position 12 detenting, mechanical spring return	P53EP	26 mm	8033035	VSVA-B-P53EP-ZTR-A1-1T1L
SB	5/3-way solenoid valve, mid-position 1x exhausted from 4 to 5, 1x pressurised from 1 to 2, switching position 14 detenting, same function in both switching positions: pressurised from 1 to 4 and exhausted from 2 to 3, reset via mechanical spring	P53AD	26 mm	8033029	VSVA-B-P53AD-ZTR-A1-1T1L	
SD	5/3-way solenoid valve, mid-position 1x exhausted from 2 to 3, 1x pressurised from 1 to 4, switching position 14 detenting, same function in both switching positions: pressurised from 1 to 2 and exhausted from 4 to 5, reset via mechanical spring	P53BD	26 mm	8039187	VSVA-B-P53BD-ZTR-A1-1T1L	
	SS	5/2-way valve, single solenoid, mechanical spring return, inductive sensor with PNP output with 0.5 m connecting cable and 4-pin sensor push-in connector M12x1	M52-M	26 mm	8033034	VSVA-B-M52-MZTR-A1-1T1L-APX-0.5
	SO	5/2-way valve, single solenoid, mechanical spring return, inductive sensor with PNP output and 3-pin sensor push-in connector M8x1	M52-M	26 mm	8033027	VSVA-B-M52-MZTR-A1-1T1L-APP

Ordering data – Solenoid valve 24 V DC

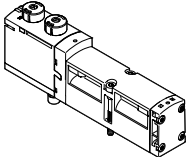
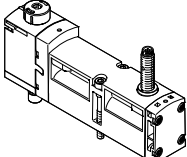
Ordering data – Solenoid valve VSVA with cover cap for MO, non-detenting (H)						
	Terminal code	Valve function	Valve code	Width	Part no.	Type
Solenoid valves, 24 V DC						
	VC	2x 2/2-way valve, single solenoid, normally closed, pneumatic spring return	T22C	26 mm	8033055	VSVA-B-T22C-AZH-A1-1T1L
	VV	2x 2/2-way valve, single solenoid, normally closed, pneumatic spring return, vacuum operation possible at 3 and 5	T22CV	26 mm	8033056	VSVA-B-T22CV-AZH-A1-1T1L
	N	2x 3/2-way valve, single solenoid, normally open	T32U	26 mm	8033038	VSVA-B-T32U-AZH-A1-1T1L
	K	2x 3/2-way valve, single solenoid, normally closed	T32C	26 mm	8033036	VSVA-B-T32C-AZH-A1-1T1L
	H	2x 3/2-way valve, single solenoid, 1x normally open, 1x normally closed	T32H	26 mm	8033040	VSVA-B-T32H-AZH-A1-1T1L
	P	2x 3/2-way valve, single solenoid, reverse operation, normally open	T32F	26 mm	8033039	VSVA-B-T32F-AZH-A1-1T1L
	Q	2x 3/2-way valve, single solenoid, reverse operation, normally closed	T32N	26 mm	8033037	VSVA-B-T32N-AZH-A1-1T1L
	R	2x 3/2-way valve, single solenoid, reverse operation, 1x normally open, 1x normally closed	T32W	26 mm	8033041	VSVA-B-T32W-AZH-A1-1T1L
	M	5/2-way valve, single solenoid, pneumatic spring return	M52-A	26 mm	8033044	VSVA-B-M52-AZH-A1-1T1L
	O	5/2-way valve, single solenoid, reset via mechanical spring	M52-M	26 mm	8033045	VSVA-B-M52-MZH-A1-1T1L
	J	5/2-way valve, double solenoid	B52	26 mm	8033042	VSVA-B-B52-ZH-A1-1T1L
	D	5/2-way valve, double solenoid, with dominant signal	D52	26 mm	8033043	VSVA-B-D52-ZH-A1-1T1L
	B	5/3-way solenoid valve, Mid-position pressurised	P53U	26 mm	8033046	VSVA-B-P53U-ZH-A1-1T1L
	G	5/3-way solenoid valve, mid-position closed	P53C	26 mm	8033048	VSVA-B-P53C-ZH-A1-1T1L
	E	5/3-way solenoid valve, Mid-position exhausted	P53E	26 mm	8033047	VSVA-B-P53E-ZH-A1-1T1L
	SA	5/3-way solenoid valve, mid-position exhausted, switching position 14 detenting, mechanical spring return	P53ED	26 mm	8033051	VSVA-B-P53ED-ZH-A1-1T1
	SE	5/3-way solenoid valve, mid-position exhausted, switching position 12 detenting, mechanical spring return	P53EP	26 mm	8033058	VSVA-B-P53EP-ZH-A1-1T1L
SB	5/3-way solenoid valve, mid-position 1x exhausted from 4 to 5, 1x pressurised from 1 to 2, switching position 14 detenting, same function in both switching positions: pressurised from 1 to 4 and exhausted from 2 to 3, reset via mechanical spring	P53AD	26 mm	8033052	VSVA-B-P53AD-ZH-A1-1T1L	
SD	5/3-way solenoid valve, mid-position 1x exhausted from 2 to 3, 1x pressurised from 1 to 4, switching position 14 detenting, same function in both switching positions: pressurised from 1 to 2 and exhausted from 4 to 5, reset via mechanical spring	P53BD	26 mm	8039188	VSVA-B-P53BD-ZH-A1-1T1L	
	SS	5/2-way valve, single solenoid, mechanical spring return, inductive sensor with PNP output with 0.5 m connecting cable and 4-pin sensor push-in connector M12x1	M52-M	26 mm	8033057	VSVA-B-M52-MZH-A1-1T1L-APX-0.5
	SO	5/2-way valve, single solenoid, mechanical spring return, inductive sensor with PNP output and 3-pin sensor push-in connector M8x1	M52-M	26 mm	8033050	VSVA-B-M52-MZH-A1-1T1L-APP

Ordering data – Solenoid valve 24 V DC

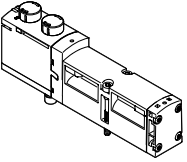
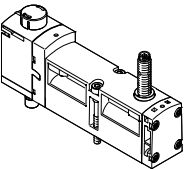
Ordering data – Solenoid valve VSVA with cover cap for MO, concealed						
	Terminal code	Valve function	Valve code	Width	Part no.	Type
Solenoid valves, 24 V DC						
	VC	2x 2/2-way valve, single solenoid, normally closed, pneumatic spring return	T22C	26 mm	8033078	VSVA-B-T22C-AZ-A1-1T1L
	VV	2x 2/2-way valve, single solenoid, normally closed, pneumatic spring return, vacuum operation possible at 3 and 5	T22CV	26 mm	8033079	VSVA-B-T22CV-AZ-A1-1T1L
	N	2x 3/2-way valve, single solenoid, normally open	T32U	26 mm	8033061	VSVA-B-T32U-AZ-A1-1T1L
	K	2x 3/2-way valve, single solenoid, normally closed	T32C	26 mm	8033059	VSVA-B-T32C-AZ-A1-1T1L
	H	2x 3/2-way valve, single solenoid, 1x normally open, 1x normally closed	T32H	26 mm	8033063	VSVA-B-T32H-AZ-A1-1T1L
	P	2x 3/2-way valve, single solenoid, reverse operation, normally open	T32F	26 mm	8033062	VSVA-B-T32F-AZ-A1-1T1L
	Q	2x 3/2-way valve, single solenoid, reverse operation, normally closed	T32N	26 mm	8033060	VSVA-B-T32N-AZ-A1-1T1L
	R	2x 3/2-way valve, single solenoid, reverse operation, 1x normally open, 1x normally closed	T32W	26 mm	8033064	VSVA-B-T32W-AZ-A1-1T1L
	M	5/2-way valve, single solenoid, pneumatic spring return	M52-A	26 mm	8033067	VSVA-B-M52-AZ-A1-1T1L
	O	5/2-way valve, single solenoid, reset via mechanical spring	M52-M	26 mm	8033068	VSVA-B-M52-MZ-A1-1T1L
	J	5/2-way valve, double solenoid	B52	26 mm	8033065	VSVA-B-B52-Z-A1-1T1L
	D	5/2-way valve, double solenoid, with dominant signal	D52	26 mm	8033066	VSVA-B-D52-Z-A1-1T1L
	B	5/3-way solenoid valve, Mid-position pressurised	P53U	26 mm	8033069	VSVA-B-P53U-Z-A1-1T1L
	G	5/3-way solenoid valve, mid-position closed	P53C	26 mm	8033071	VSVA-B-P53C-Z-A1-1T1L
	E	5/3-way solenoid valve, Mid-position exhausted	P53E	26 mm	8033070	VSVA-B-P53E-Z-A1-1T1L
	SA	5/3-way solenoid valve, mid-position exhausted, switching position 14 detenting, mechanical spring return	P53ED	26 mm	8033074	VSVA-B-P53ED-Z-A1-1T1L
	SE	5/3-way solenoid valve, mid-position exhausted, switching position 12 detenting, mechanical spring return	P53EP	26 mm	8033081	VSVA-B-P53EP-Z-A1-1T1L
	SB	5/3-way solenoid valve, mid-position 1x exhausted from 4 to 5, 1x pressurised from 1 to 2, switching position 14 detenting, same function in both switching positions: pressurised from 1 to 4 and exhausted from 2 to 3, reset via mechanical spring	P53AD	26 mm	8033075	VSVA-B-P53AD-Z-A1-1T1L
	SD	5/3-way solenoid valve, mid-position 1x exhausted from 2 to 3, 1x pressurised from 1 to 4, switching position 14 detenting, same function in both switching positions: pressurised from 1 to 2 and exhausted from 4 to 5, reset via mechanical spring	P53BD	26 mm	8039189	VSVA-B-P53BD-Z-A1-1T1L
	SS	5/2-way valve, single solenoid, mechanical spring return, inductive sensor with PNP output with 0.5 m connecting cable and 4-pin sensor push-in connector M12x1	M52-M	26 mm	8033080	VSVA-B-M52-MZ-A1-1T1L-APX-0.5
	SO	5/2-way valve, single solenoid, mechanical spring return, inductive sensor with PNP output and 3-pin sensor push-in connector M8x1	M52-M	26 mm	8033073	VSVA-B-M52-MZ-A1-1T1L-APP

Ordering data – Solenoid valve 24 V DC – for VTSA-F-CB

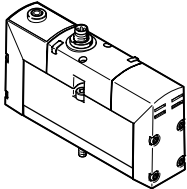
Ordering data – Solenoid valve VSVA with central plug, 3-pin, M12x1, round design						
	Terminal code	Valve function	Valve code	Width	Part no.	Type
Solenoid valves, 24 V DC						
	QN	2x 3/2-way valve, single solenoid, normally open	T32U	26 mm	534543	VSVA-B-T32U-AZH-A1-1R5L
	QK	2x 3/2-way valve, single solenoid, normally closed	T32C	26 mm	534542	VSVA-B-T32C-AZH-A1-1R5L
	QH	2x 3/2-way valve, single solenoid, 1x normally open, 1x normally closed	T32H	26 mm	534544	VSVA-B-T32H-AZH-A1-1R5L
	QM	5/2-way valve, single solenoid, pneumatic spring return	M52-A	26 mm	534545	VSVA-B-M52-AZH-A1-1R5L
	QO	5/2-way valve, single solenoid, reset via mechanical spring	M52-M	26 mm	534546	VSVA-B-M52-MZH-A1-1R5L
	QJ	5/2-way valve, double solenoid	B52	26 mm	534547	VSVA-B-B52-ZH-A1-1R5L
	QD	5/2-way valve, double solenoid, with dominant signal	D52	26 mm	534548	VSVA-B-D52-ZH-A1-1R5L
	QB	5/3-way solenoid valve, Mid-position pressurised	P53U	26 mm	534551	VSVA-B-P53U-ZH-A1-1R5L
	QG	5/3-way solenoid valve, mid-position closed	P53C	26 mm	534549	VSVA-B-P53C-ZH-A1-1R5L
	QE	5/3-way solenoid valve, Mid-position exhausted	P53E	26 mm	534550	VSVA-B-P53E-ZH-A1-1R5L

 **Note**

Additional information about solenoid valves with central plug can be found in the existing catalogue documentation at:
www.festo.com/catalogue/... → Support Portal:
 Standards-based valve VSVA to ISO 15407-1 and ISO 5599-1 with M8 or M12 central plug

Datasheet – Solenoid valve width 42 mm

-  - Valve width
to ISO 5599-2
42 mm (ISO 1)

-  - Flow rate
Valve width 42 mm:
VTSA up to 1300 l/min
VTSA-F up to 1860 l/min
VTSA-F-CB up to 1860 l/min

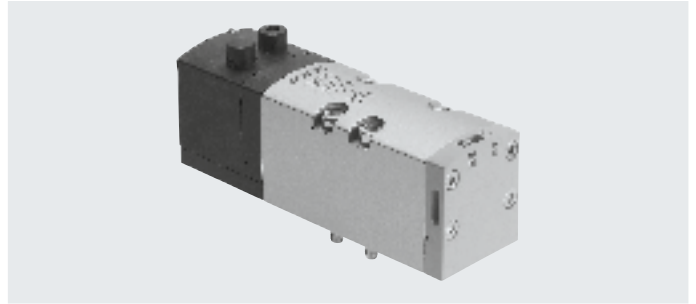

Safety characteristics for valve

Conforms to	EN 13849-1/2
Shock resistance	Shock test with severity level 2, to EN 60068-2-27
Vibration resistance	Transport application test with severity level 2, to EN 60068-2-6

Safety characteristics for valve, 24 V DC

Valve function (with valve code)	Terminal code	Test pulses	
		Max. positive test pulse with 0 signal [µs]	Max. negative test pulse with 1 signal [µs]
5/2-way, double solenoid (B52)	J	1400	900
5/2-way, double solenoid with dominant signal (D52)	D	1600	1100
5/2-way, single solenoid (M52-A)	M	1400	900
5/2-way, single solenoid (M52-M)	O	1400	900
5/3-way, closed (P53C)	G	1400	900
5/3-way, exhausted (P53E)	E	1400	900
5/3-way, pressurised (P53U)	B	1400	900
5/3-way, pressurised 1 to 2, 4 to 5 closed (P53F)	VG	-	-
2x3/2-way, single solenoid, closed (T32C)	K	1600	1100
2x3/2-way, single solenoid, open (T32U)	N	1600	1100
2x3/2-way, single solenoid, open/closed (T32H)	H	1600	1100
2x3/2-way, single solenoid, closed (T32N)	Q	1600	1100
2x3/2-way, single solenoid, open (T32F)	P	1600	1100
2x3/2-way, single solenoid, open/closed (T32W)	R	1600	1100
2x2/2-way, single solenoid, closed (T22C)	VC	1600	1100
2x2/2-way, single solenoid, closed (T22CV)	VV	1600	1100

Datasheet – Solenoid valve width 42 mm

Datasheet for valve							
Valve function (with valve code)	Terminal code	Flow direction			Reset method		Weight [g]
		Any	Reversible only	Not reversible	Pneumatic spring	Mechanical spring	
5/2-way, double solenoid (B52)	J	■	–	–	–	–	439
5/2-way, double solenoid with dominant signal (D52)	D	■	–	–	–	–	439
5/2-way, single solenoid (M52-A)	M	■	–	–	■	–	426
5/2-way, single solenoid (M52-M)	O	■	–	–	–	■	426
5/3-way, closed ¹⁾ (P53C)	G	■	–	–	–	■	456
5/3-way, exhausted ¹⁾ (P53E)	E	■	–	–	–	■	456
5/3-way, pressurised ¹⁾ (P53U)	B	■	–	–	–	■	456
5/3-way, pressurised 1 to 2, 4 to 5 closed (P53F)	VG	■	–	–	–	–	456
2x3/2-way, single solenoid, closed (T32C)	K	–	–	■	■	–	442
2x3/2-way, single solenoid, open (T32U)	N	–	–	■	■	–	442
2x3/2-way, single solenoid, open/closed (T32H)	H	–	–	■	■	–	442
2x3/2-way, single solenoid, closed (T32N)	Q	–	■	–	■	–	442
2x3/2-way, single solenoid, open (T32F)	P	–	■	–	■	–	442
2x3/2-way, single solenoid, open/closed (T32W)	R	–	■	–	■	–	442
2x2/2-way, single solenoid, closed (T22C)	VC	–	–	■	■	–	442
2x2/2-way, single solenoid, closed (T22CV)	VV	■	–	–	■	–	442

- 1) If neither solenoid coil is energised, the valve is moved to its mid-position by spring force.
If both solenoid coils are energised at the same time, the valve remains in the previously assumed switching position.

Standard nominal flow rate of valve/valve terminal [l/min]						
Valve function (with valve code)	Terminal code	Flow rate				Valve on individual sub-base
		Valve	Valve on valve terminal			
			VTSA	VTSA-F	VTSA-F-CB	
5/2-way, double solenoid (B52)	J	2000	1300	1860	1860	1500
5/2-way, double solenoid with dominant signal (D52)	D	2000	1300	1860	1860	1500
5/2-way, single solenoid (M52-A)	M	2000	1300	1860	1860	1500
5/2-way, single solenoid (M52-M)	O	2000	1300	1860	1860	1500
5/3-way, closed (P53C)	G	1900 ¹⁾ 950 ²⁾	1200 ¹⁾ 800 ²⁾	1690 ¹⁾ 830 ²⁾	1690 ¹⁾ 830 ²⁾	1400 ¹⁾ 800 ²⁾
5/3-way, exhausted (P53E)	E	1900 ¹⁾ 950 ²⁾	1200 ¹⁾ 800 ²⁾	1690 ¹⁾ 830 ²⁾	1690 ¹⁾ 830 ²⁾	1400 ¹⁾ 800 ²⁾
5/3-way, pressurised (P53U)	B	1900 ¹⁾ 950 ²⁾	1200 ¹⁾ 800 ²⁾	1690 ¹⁾ 830 ²⁾	1690 ¹⁾ 830 ²⁾	1400 ¹⁾ 800 ²⁾
5/3-way, pressurised 1 to 2, 4 to 5 closed (P53F)	VG	1700 ¹⁾ 700 ²⁾	1400 ¹⁾ 800 ²⁾	1700 ¹⁾ 700 ²⁾	1700 ¹⁾ 700 ²⁾	1400 ¹⁾ 700 ²⁾
2x3/2-way, single solenoid, closed (T32C)	K	1600	1200	1300	1300	1200
2x3/2-way, single solenoid, open (T32U)	N	1600	1200	1300	1300	1200
2x3/2-way, single solenoid, open/closed (T32H)	H	1600	1200	1300	1300	1200
2x3/2-way, single solenoid, closed (T32N)	Q	1600	1200	1300	1300	1200
2x3/2-way, single solenoid, open (T32F)	P	1600	1200	1300	1300	1200
2x3/2-way, single solenoid, open/closed (T32W)	R	1600	1200	1300	1300	1200
2x2/2-way, single solenoid, closed (T22C)	VC	1600	1400	1500	1500	1400
2x2/2-way, single solenoid, closed (T22CV)	VV	1600	1400	1500	1500	1400

- 1) Switching position
2) Mid-position

Datasheet – Solenoid valve width 42 mm

Valve switching times in [ms]				
Valve function (with valve code)	Terminal code	24 V DC		
		On	Off	Changeover
5/2-way, double solenoid (B52)	J	–	–	16
5/2-way, double solenoid with dominant signal (D52)	D	–	–	19
5/2-way, single solenoid (M52-A)	M	27	45	–
5/2-way, single solenoid (M52-M)	O	22	60	–
5/3-way, closed (P53C)	G	22	65	38
5/3-way, exhausted (P53E)	E	22	65	38
5/3-way, pressurised (P53U)	B	22	65	38
5/3-way, pressurised 1 to 2, 4 to 5 closed (P53F)	VG	22	65	38
2x3/2-way, single solenoid, closed (T32C)	K	20	38	–
2x3/2-way, single solenoid, open (T32U)	N	20	38	–
2x3/2-way, single solenoid, open/closed (T32H)	H	20	38	–
2x3/2-way, single solenoid, closed (T32N)	Q	34	28	–
2x3/2-way, single solenoid, open (T32F)	P	34	28	–
2x3/2-way, single solenoid, open/closed (T32W)	R	34	28	–
2x2/2-way, single solenoid, closed (T22C)	VC	20	38	–
2x2/2-way, single solenoid, closed (T22CV)	VV	20	38	–

Characteristic coil data		
Valve function (with valve code)	Terminal code	Characteristic coil data at 24 V DC in [W]
5/2-way, double solenoid (B52)	J	1.6
5/2-way, double solenoid with dominant signal (D52)	D	1.3
5/2-way, single solenoid (M52-A)	M	1.6
5/2-way, single solenoid (M52-M)	O	1.6
5/3-way, closed (P53C)	G	1.6
5/3-way, exhausted (P53E)	E	1.6
5/3-way, pressurised (P53U)	B	1.6
5/3-way, pressurised 1 to 2, 4 to 5 closed (P53F)	VG	1.6
2x3/2-way, single solenoid, closed (T32C)	K	1.3
2x3/2-way, single solenoid, open (T32U)	N	1.3
2x3/2-way, single solenoid, open/closed (T32H)	H	1.3
2x3/2-way, single solenoid, closed (T32N)	Q	1.3
2x3/2-way, single solenoid, open (T32F)	P	1.3
2x3/2-way, single solenoid, open/closed (T32W)	R	1.3
2x2/2-way, single solenoid, closed (T22C)	VC	1.3
2x2/2-way, single solenoid, closed (T22CV)	VV	1.3

Max. current consumption per solenoid coil			
Type	T22, T32	B52, D52, M52, P53	
At nominal voltage 24 V DC (valves with holding current reduction)			
Nominal pick-up current	[mA]	60	72
Nominal current following current reduction	[mA]	–	–
Time until current reduction	[ms]	30	30

Materials	
Housing	Die-cast aluminium, PA
Seals	FPM, NBR, HNBR
Screws	Galvanised steel
Note on materials	RoHS-compliant

Ordering data – Solenoid valve 24 V DC

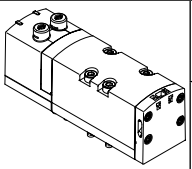
Ordering data – Solenoid valve VSVA, MO non-detenting/detenting (D)						
	Terminal code	Valve function	Valve code	Width	Part no.	Type
Solenoid valves, 24 V DC						
	VC	2x 2/2-way valve, single solenoid, Normally closed, pneumatic spring return	T22C	42 mm	561340	VSVA-B-T22C-AZD-D1-1T1L
	WV	2x 2/2-way valve, single solenoid, normally closed, pneumatic spring return, vacuum operation possible at 3 and 5	T22CV	42 mm	561344	VSVA-B-T22CV-AZD-D1-1T1L
	N	2x 3/2-way valve, single solenoid, normally open	T32U	42 mm	543692	VSVA-B-T32U-AZD-D1-1T1L
	K	2x 3/2-way valve, single solenoid, normally closed	T32C	42 mm	543690	VSVA-B-T32C-AZD-D1-1T1L
	H	2x 3/2-way valve, single solenoid, 1x normally open, 1x normally closed	T32H	42 mm	543694	VSVA-B-T32H-AZD-D1-1T1L
	P	2x 3/2-way valve, single solenoid, reverse operation, normally open	T32F	42 mm	543693	VSVA-B-T32F-AZD-D1-1T1L
	Q	2x 3/2-way valve, single solenoid, reverse operation, normally closed	T32N	42 mm	543691	VSVA-B-T32N-AZD-D1-1T1L
	R	2x 3/2-way valve, single solenoid, reverse operation, 1x normally open, 1x normally closed	T32W	42 mm	543695	VSVA-B-T32W-AZD-D1-1T1L
	M	5/2-way valve, single solenoid, pneumatic spring return	M52-A	42 mm	543698	VSVA-B-M52-AZD-D1-1T1L
	O	5/2-way valve, single solenoid, reset via mechanical spring	M52-M	42 mm	543699	VSVA-B-M52-MZD-D1-1T1L
	J	5/2-way valve, double solenoid	B52	42 mm	543696	VSVA-B-B52-ZD-D1-1T1L
	D	5/2-way valve, double solenoid, with dominant signal	D52	42 mm	543697	VSVA-B-D52-ZD-D1-1T1L
	B	5/3-way solenoid valve, Mid-position pressurised	P53U	42 mm	543700	VSVA-B-P53U-ZD-D1-1T1L
	G	5/3-way solenoid valve, mid-position closed	P53C	42 mm	543702	VSVA-B-P53C-ZD-D1-1T1L
	E	5/3-way solenoid valve, Mid-position exhausted	P53E	42 mm	543701	VSVA-B-P53E-ZD-D1-1T1L
	VG	5/3-way solenoid valve, mid-position pressurised 1 to 2, 4 to 5 closed	P53F	42 mm	8000464	VSVA-B-P53F-ZD-D1-1T1L

Ordering data – Solenoid valve 24 V DC

Ordering data – Solenoid valve VSVA with cover cap for MO non-detenting/heavy duty, detenting via accessory (TR)						
	Terminal code	Valve function	Valve code	Width	Part no.	Type
Solenoid valves, 24 V DC						
	VC	2x 2/2-way valve, single solenoid, normally closed, pneumatic spring return	T22C	42 mm	8034781	VSVA-B-T22C-AZTR-D1-1T1L
	VV	2x 2/2-way valve, single solenoid, normally closed, pneumatic spring return, vacuum operation possible at 3 and 5	T22CV	42 mm	8034782	VSVA-B-T22CV-AZTR-D1-1T1L
	N	2x 3/2-way valve, single solenoid, normally open	T32U	42 mm	8034770	VSVA-B-T32U-AZTR-D1-1T1L
	K	2x 3/2-way valve, single solenoid, normally closed	T32C	42 mm	8034768	VSVA-B-T32C-AZTR-D1-1T1L
	H	2x 3/2-way valve, single solenoid, 1x normally open, 1x normally closed	T32H	42 mm	8034772	VSVA-B-T32H-AZTR-D1-1T1L
	P	2x 3/2-way valve, single solenoid, reverse operation, normally open	T32F	42 mm	8034771	VSVA-B-T32F-AZTR-D1-1T1L
	Q	2x 3/2-way valve, single solenoid, reverse operation, normally closed	T32N	42 mm	8034769	VSVA-B-T32N-AZTR-D1-1T1L
	R	2x 3/2-way valve, single solenoid, reverse operation, 1x normally open, 1x normally closed	T32W	42 mm	8034773	VSVA-B-T32W-AZTR-D1-1T1L
	M	5/2-way valve, single solenoid, pneumatic spring return	M52-A	42 mm	8034776	VSVA-B-M52-AZTR-D1-1T1L
	O	5/2-way valve, single solenoid, reset via mechanical spring	M52-M	42 mm	8034777	VSVA-B-M52-MZTR-D1-1T1L
	J	5/2-way valve, double solenoid	B52	42 mm	8034774	VSVA-B-B52-ZTR-D1-1T1L
	D	5/2-way valve, double solenoid, with dominant signal	D52	42 mm	8034775	VSVA-B-D52-ZTR-D1-1T1L
	B	5/3-way solenoid valve, Mid-position pressurised	P53U	42 mm	8034778	VSVA-B-P53U-ZTR-D1-1T1L
	G	5/3-way solenoid valve, mid-position closed	P53C	42 mm	8034780	VSVA-B-P53C-ZTR-D1-1T1L
	E	5/3-way solenoid valve, Mid-position exhausted	P53E	42 mm	8034779	VSVA-B-P53E-ZTR-D1-1T1L
	VG	5/3-way solenoid valve, mid-position pressurised 1 to 2, 4 to 5 closed	P53F	42 mm	8034783	VSVA-B-P53F-ZTR-D1-1T1L

Ordering data – Solenoid valve 24 V DC

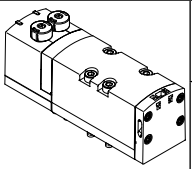
Ordering data – Solenoid valve VSVA with cover cap for MO, non-detenting (H)						
	Terminal code	Valve function	Valve code	Width	Part no.	Type
Solenoid valves, 24 V DC						
	VC	2x 2/2-way valve, single solenoid, normally closed, pneumatic spring return	T22C	42 mm	8034812	VSVA-B-T22C-AZH-D1-1T1L
	WV	2x 2/2-way valve, single solenoid, normally closed, pneumatic spring return, vacuum operation possible at 3 and 5	T22CV	42 mm	8034813	VSVA-B-T22CV-AZH-D1-1T1L
	N	2x 3/2-way valve, single solenoid, normally open	T32U	42 mm	8034801	VSVA-B-T32U-AZH-D1-1T1L
	K	2x 3/2-way valve, single solenoid, normally closed	T32C	42 mm	8034799	VSVA-B-T32C-AZH-D1-1T1L
	H	2x 3/2-way valve, single solenoid, 1x normally open, 1x normally closed	T32H	42 mm	8034803	VSVA-B-T32H-AZH-D1-1T1L
	P	2x 3/2-way valve, single solenoid, reverse operation, normally open	T32F	42 mm	8034802	VSVA-B-T32F-AZH-D1-1T1L
	Q	2x 3/2-way valve, single solenoid, reverse operation, normally closed	T32N	42 mm	8034800	VSVA-B-T32N-AZH-D1-1T1L
	R	2x 3/2-way valve, single solenoid, reverse operation, 1x normally open, 1x normally closed	T32W	42 mm	8034804	VSVA-B-T32W-AZH-D1-1T1L
	M	5/2-way valve, single solenoid, pneumatic spring return	M52-A	42 mm	8034807	VSVA-B-M52-AZH-D1-1T1L
	O	5/2-way valve, single solenoid, reset via mechanical spring	M52-M	42 mm	8034808	VSVA-B-M52-MZH-D1-1T1L
	J	5/2-way valve, double solenoid	B52	42 mm	8034805	VSVA-B-B52-ZH-D1-1T1L
	D	5/2-way valve, double solenoid, with dominant signal	D52	42 mm	8034806	VSVA-B-D52-ZH-D1-1T1L
	B	5/3-way solenoid valve, Mid-position pressurised	P53U	42 mm	8034809	VSVA-B-P53U-ZH-D1-1T1L
	G	5/3-way solenoid valve, mid-position closed	P53C	42 mm	8034811	VSVA-B-P53C-ZH-D1-1T1L
	E	5/3-way solenoid valve, Mid-position exhausted	P53E	42 mm	8034810	VSVA-B-P53E-ZH-D1-1T1L
VG	5/3-way solenoid valve, mid-position pressurised 1 to 2, 4 to 5 closed	P53F	42 mm	8034814	VSVA-B-P53F-ZH-D1-1T1L	

Ordering data – Solenoid valve 24 V DC

Ordering data – Solenoid valve VSVA with cover cap for MO, concealed						
	Terminal code	Valve function	Valve code	Width	Part no.	Type
Solenoid valves, 24 V DC						
	VC	2x 2/2-way valve, single solenoid, normally closed, pneumatic spring return	T22C	42 mm	8034843	VSVA-B-T22C-AZ-D1-1T1L
	VV	2x 2/2-way valve, single solenoid, normally closed, pneumatic spring return, vacuum operation possible at 3 and 5	T22CV	42 mm	8034844	VSVA-B-T22CV-AZ-D1-1T1L
	N	2x 3/2-way valve, single solenoid, normally open	T32U	42 mm	8034832	VSVA-B-T32U-AZ-D1-1T1L
	K	2x 3/2-way valve, single solenoid, normally closed	T32C	42 mm	8034830	VSVA-B-T32C-AZ-D1-1T1L
	H	2x 3/2-way valve, single solenoid, 1x normally open, 1x normally closed	T32H	42 mm	8034834	VSVA-B-T32H-AZ-D1-1T1L
	P	2x 3/2-way valve, single solenoid, reverse operation, normally open	T32F	42 mm	8034833	VSVA-B-T32F-AZ-D1-1T1L
	Q	2x 3/2-way valve, single solenoid, reverse operation, normally closed	T32N	42 mm	8034831	VSVA-B-T32N-AZ-D1-1T1L
	R	2x 3/2-way valve, single solenoid, reverse operation, 1x normally open, 1x normally closed	T32W	42 mm	8034835	VSVA-B-T32W-AZ-D1-1T1L
	M	5/2-way valve, single solenoid, pneumatic spring return	M52-A	42 mm	8034838	VSVA-B-M52-AZ-D1-1T1L
	O	5/2-way valve, single solenoid, reset via mechanical spring	M52-M	42 mm	8034839	VSVA-B-M52-MZ-D1-1T1L
	J	5/2-way valve, double solenoid	B52	42 mm	8034836	VSVA-B-B52-Z-D1-1T1L
	D	5/2-way valve, double solenoid, with dominant signal	D52	42 mm	8034837	VSVA-B-D52-Z-D1-1T1L
	B	5/3-way solenoid valve, Mid-position pressurised	P53U	42 mm	8034840	VSVA-B-P53U-Z-D1-1T1L
	G	5/3-way solenoid valve, mid-position closed	P53C	42 mm	8034842	VSVA-B-P53C-Z-D1-1T1L
	E	5/3-way solenoid valve, Mid-position exhausted	P53E	42 mm	8034841	VSVA-B-P53E-Z-D1-1T1L
	VG	5/3-way solenoid valve, mid-position pressurised 1 to 2, 4 to 5 closed	P53F	42 mm	8034845	VSVA-B-P53F-Z-D1-1T1L

Ordering data – Solenoid valve 24 V DC – for VTSA-F-CB

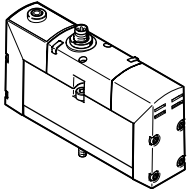
Ordering data – Solenoid valve VSVA with central plug, 3-pin, M12x1, round design						
	Terminal code	Valve function	Valve code	Width	Part no.	Type
Solenoid valves, 24 V DC						
	QN	2x 3/2-way valve, single solenoid, normally open	T32U	42 mm	561370	VSVA-B-T32U-AZD-D1-1R5L
	QK	2x 3/2-way valve, single solenoid, Normally closed	T32C	42 mm	561369	VSVA-B-T32C-AZD-D1-1R5L
	QH	2x 3/2-way valve, single solenoid, 1x normally open, 1x normally closed	T32H	42 mm	561371	VSVA-B-T32H-AZD-D1-1R5L
	QM	5/2-way valve, single solenoid, pneumatic spring return	M52-A	42 mm	561372	VSVA-B-M52-AZD-D1-1R5L
	QO	5/2-way valve, single solenoid, reset via mechanical spring	M52-M	42 mm	561373	VSVA-B-M52-MZD-D1-1R5L
	QJ	5/2-way valve, double solenoid	B52	42 mm	561374	VSVA-B-B52-ZD-D1-1R5L
	QD	5/2-way valve, double solenoid, with dominant signal	D52	42 mm	561375	VSVA-B-D52-ZD-D1-1R5L
	QB	5/3-way solenoid valve, Mid-position pressurised	P53U	42 mm	561378	VSVA-B-P53U-ZD-D1-1R5L
	QG	5/3-way solenoid valve, mid-position closed	P53C	42 mm	561376	VSVA-B-P53C-ZD-D1-1R5L
	QE	5/3-way solenoid valve, Mid-position exhausted	P53E	42 mm	561377	VSVA-B-P53E-ZD-D1-1R5L

 **Note**

Additional information about solenoid valves with central plug can be found in the existing catalogue documentation at:
www.festo.com/catalogue/... → Support Portal:
 Standards-based valve VSVA to ISO 15407-1 and ISO 5599-1 with M8 or M12 central plug

Datasheet – Solenoid valve width 52 mm

-  - Valve width
to ISO 5599-2
52 mm (ISO 2)

-  - Flow rate
Valve width 52 mm:
VTSA up to 2900 l/min
VTSA-F up to 2900 l/min
VTSA-F-CB up to 2900 l/min

-  - Voltage
24 V DC

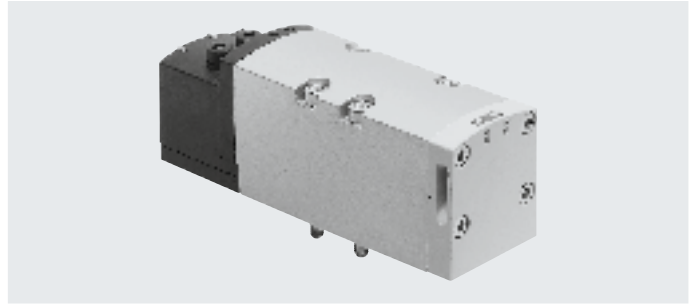

Safety characteristics for valve

Conforms to	EN 13849-1/2	
CE marking (see declaration of conformity)	Direct voltage 24 V DC	To EU EMC Directive ¹⁾
KC marking	KC EMC	
Shock resistance	Shock test with severity level 2, to EN 60068-2-27	
Vibration resistance	Transport application test with severity level 2, to EN 60068-2-6	

1) For information about the area of use, see the EC declaration of conformity at: www.festo.com/catalogue/... → Support/Downloads.
If the devices are subject to usage restrictions in residential, commercial or light-industrial environments, further measures for the reduction of the emitted interference may be necessary.

Safety characteristics for valve, 24 V DC

Valve function (with valve code)	Terminal code	Test pulses	
		Max. positive test pulse with logic 0 [µs]	Max. negative test pulse with logic 1 [µs]
5/2-way, double solenoid (B52)	J	1000	3500
5/2-way, double solenoid with dominant signal (D52)	D	1000	3500
5/2-way, single solenoid (M52-A)	M	1000	3500
5/2-way, single solenoid (M52-M)	O	1000	3500
5/3-way, closed (P53C)	G	1000	3500
5/3-way, exhausted (P53E)	E	1000	3500
5/3-way, pressurised (P53U)	B	1000	3500
5/3-way, pressurised 1 to 2, 4 to 5 closed (P53F)	VG	-	-
2x3/2-way, single solenoid, closed (T32C)	K	1000	3500
2x3/2-way, single solenoid, open (T32U)	N	1000	3500
2x3/2-way, single solenoid, open/closed (T32H)	H	1000	3500
2x3/2-way, single solenoid, closed (T32N)	Q	1000	3500
2x3/2-way, single solenoid, open (T32F)	P	1000	3500
2x3/2-way, single solenoid, open/closed (T32W)	R	1000	3500
2x2/2-way, single solenoid, closed (T22C)	VC	1000	3500

Datasheet – Solenoid valve width 52 mm

Datasheet for valve							
Valve function (with valve code)	Terminal code	Flow direction			Reset method		Weight [g]
		Any	Reversible only	Not reversible	Pneumatic spring	Mechanical spring	
5/2-way, double solenoid (B52)	J	■	–	–	–	–	732
5/2-way, double solenoid with dominant signal (D52)	D	■	–	–	–	–	732
5/2-way, single solenoid (M52-A)	M	■	–	–	■	–	702
5/2-way, single solenoid (M52-M)	O	■	–	–	–	■	702
5/3-way, closed ¹⁾ (P53C)	G	■	–	–	–	■	780
5/3-way, exhausted ¹⁾ (P53E)	E	■	–	–	–	■	780
5/3-way, pressurised ¹⁾ (P53U)	B	■	–	–	–	■	780
5/3-way, pressurised 1 to 2, 4 to 5 closed (P53F)	VG	■	–	–	–	–	780
2x3/2-way, single solenoid, closed (T32C)	K	–	–	■	■	–	740
2x3/2-way, single solenoid, open (T32U)	N	–	–	■	■	–	740
2x3/2-way, single solenoid, open/closed (T32H)	H	–	–	■	■	–	740
2x3/2-way, single solenoid, closed (T32N)	Q	–	■	–	■	–	740
2x3/2-way, single solenoid, open (T32F)	P	–	■	–	■	–	740
2x3/2-way, single solenoid, open/closed (T32W)	R	–	■	–	■	–	740
2x2/2-way, single solenoid, closed (T22C)	VC	–	–	■	■	–	740

- 1) If neither solenoid coil is energised, the valve is moved to its mid-position by spring force.
If both solenoid coils are energised at the same time, the valve remains in the previously assumed switching position

Standard nominal flow rate of valve/valve terminal [l/min]						
Valve function (with valve code)	Terminal code	Flow rate				Valve on individual sub-base
		Valve	Valve on valve terminal			
			VTSA	VTSA-F	VTSA-F-CB	
5/2-way, double solenoid (B52)	J	4000	2900	2900	2900	3400
5/2-way, double solenoid with dominant signal (D52)	D	4000	2900	2900	2900	3400
5/2-way, single solenoid (M52-A)	M	4000	2900	2900	2900	3400
5/2-way, single solenoid (M52-M)	O	4000	2900	2900	2900	3400
5/3-way, closed (P53C)	G	3600 ¹⁾ 1700 ²⁾	2800 ¹⁾ 1700 ²⁾	2800 ¹⁾ 1700 ²⁾	2800 ¹⁾ 1700 ²⁾	3200 ¹⁾ 1700 ²⁾
5/3-way, exhausted (P53E)	E	3600 ¹⁾ 1700 ²⁾	2800 ¹⁾ 1700 ²⁾	2800 ¹⁾ 1700 ²⁾	2800 ¹⁾ 1700 ²⁾	3200 ¹⁾ 1700 ²⁾
5/3-way, pressurised (P53U)	B	3600 ¹⁾ 1700 ²⁾	2800 ¹⁾ 1700 ²⁾	2800 ¹⁾ 1700 ²⁾	2800 ¹⁾ 1700 ²⁾	3200 ¹⁾ 1700 ²⁾
5/3-way, pressurised 1 to 2, 4 to 5 closed (P53F)	VG	3000 ¹⁾ 900 ²⁾	2300 ¹⁾ 900 ²⁾	2300 ¹⁾ 900 ²⁾	2300 ¹⁾ 900 ²⁾	2600 ¹⁾ 900 ²⁾
2x3/2-way, single solenoid, closed (T32C)	K	3000	2400	2400	2400	2600
2x3/2-way, single solenoid, open (T32U)	N	3000	2400	2400	2400	2600
2x3/2-way, single solenoid, open/closed (T32H)	H	3000	2400	2400	2400	2600
2x3/2-way, single solenoid, closed (T32N)	Q	3000	2400	2400	2400	2600
2x3/2-way, single solenoid, open (T32F)	P	3000	2400	2400	2400	2600
2x3/2-way, single solenoid, open/closed (T32W)	R	3000	2400	2400	2400	2600
2x2/2-way, single solenoid, closed (T22C)	VC	4000	2800	2800	2800	3400

- 1) Switching position
2) Mid-position

Datasheet – Solenoid valve width 52 mm

Valve switching times in [ms]				
Valve function (with valve code)	Terminal code	24 V DC		
		On	Off	Changeover
5/2-way, double solenoid (B52)	J	–	–	18
5/2-way, double solenoid with dominant signal (D52)	D	–	–	18
5/2-way, single solenoid (M52-A)	M	40	45	–
5/2-way, single solenoid (M52-M)	O	20	60	–
5/3-way, closed (P53C)	G	23	60	38
5/3-way, exhausted (P53E)	E	23	60	38
5/3-way, pressurised (P53U)	B	23	60	38
5/3-way, pressurised 1 to 2, 4 to 5 closed (P53F)	VG	23	60	38
2x3/2-way, single solenoid, closed (T32C)	K	20	35	–
2x3/2-way, single solenoid, open (T32U)	N	20	35	–
2x3/2-way, single solenoid, open/closed (T32H)	H	20	35	–
2x3/2-way, single solenoid, closed (T32N)	Q	20	35	–
2x3/2-way, single solenoid, open (T32F)	P	20	35	–
2x3/2-way, single solenoid, open/closed (T32W)	R	20	35	–
2x2/2-way, single solenoid, closed (T22C)	VC	14	35	–

Characteristic coil data		
Valve function (with valve code)	Terminal code	Characteristic coil data at 24 V DC in [W]
5/2-way, double solenoid with dominant signal (D52)	D	4.6
5/2-way, single solenoid (M52-A)	M	4.6
5/2-way, single solenoid (M52-M)	O	4.6
5/3-way, closed (P53C)	G	4.6
5/3-way, exhausted (P53E)	E	4.6
5/3-way, pressurised (P53U)	B	4.6
5/3-way, pressurised 1 to 2, 4 to 5 closed (P53F)	VG	4.6
2x3/2-way, single solenoid, closed (T32C)	K	4.6
2x3/2-way, single solenoid, open (T32U)	N	4.6
2x3/2-way, single solenoid, open/closed (T32H)	H	4.6
2x3/2-way, single solenoid, closed (T32N)	Q	4.6
2x3/2-way, single solenoid, open (T32F)	P	4.6
2x3/2-way, single solenoid, open/closed (T32W)	R	4.6
2x2/2-way, single solenoid, closed (T22C)	VC	4.6

Max. current consumption per solenoid coil**At nominal voltage 24 V DC (valves with holding current reduction)**

Nominal pick-up current	[mA]	165
Nominal current following current reduction	[mA]	35
Time until current reduction	[ms]	30

Materials

Housing	Die-cast aluminium, PA
Seals	FPM, NBR, HNBR
Screws	Galvanised steel
Note on materials	RoHS-compliant

Ordering data – Solenoid valve 24 V DC

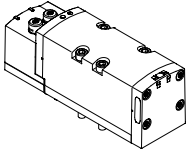
Ordering data – Solenoid valve VSVA, MO non-detenting/detenting (D)						
	Terminal code	Valve function	Valve code	Width	Part no.	Type
Solenoid valves, 24 V DC						
	VC	2x 2/2-way valve, single solenoid, normally closed, pneumatic spring return	T22C	52 mm	560831	VSVA-B-T22C-AZD-D2-1T1L
	N	2x 3/2-way valve, single solenoid, normally open	T32U	52 mm	560827	VSVA-B-T32U-AZD-D2-1T1L
	K	2x 3/2-way valve, single solenoid, normally closed	T32C	52 mm	560825	VSVA-B-T32C-AZD-D2-1T1L
	H	2x 3/2-way valve, single solenoid, 1x normally open, 1x normally closed	T32H	52 mm	560829	VSVA-B-T32H-AZD-D2-1T1L
	P	2x 3/2-way valve, single solenoid, reverse operation, normally open	T32F	52 mm	560828	VSVA-B-T32F-AZD-D2-1T1L
	Q	2x 3/2-way valve, single solenoid, reverse operation, normally closed	T32N	52 mm	560826	VSVA-B-T32N-AZD-D2-1T1L
	R	2x 3/2-way valve, single solenoid, reverse operation, 1x normally open, 1x normally closed	T32W	52 mm	560830	VSVA-B-T32W-AZD-D2-1T1L
	M	5/2-way valve, single solenoid, pneumatic spring return	M52-A	52 mm	560820	VSVA-B-M52-AZD-D2-1T1L
	O	5/2-way valve, single solenoid, reset via mechanical spring	M52-M	52 mm	560821	VSVA-B-M52-MZD-D2-1T1L
	J	5/2-way valve, double solenoid	B52	52 mm	560818	VSVA-B-B52-ZD-D2-1T1L
	D	5/2-way valve, double solenoid, with dominant signal	D52	52 mm	560819	VSVA-B-D52-ZD-D2-1T1L
	B	5/3-way solenoid valve, Mid-position pressurised	P53U	52 mm	560822	VSVA-B-P53U-ZD-D2-1T1L
	G	5/3-way solenoid valve, mid-position closed	P53C	52 mm	560824	VSVA-B-P53C-ZD-D2-1T1L
	E	5/3-way solenoid valve, Mid-position exhausted	P53E	52 mm	560823	VSVA-B-P53E-ZD-D2-1T1L
	VG	5/3-way solenoid valve, mid-position pressurised 1 to 2, 4 to 5 closed	P53F	52 mm	8000465	VSVA-B-P53F-ZD-D2-1T1L

Ordering data – Solenoid valve 24 V DC

Ordering data – Solenoid valve VSVA with cover cap for MO non-detenting/heavy duty, detenting via accessory (TR)

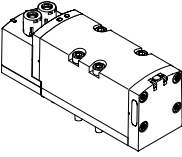
	Terminal code	Valve function	Valve code	Width	Part no.	Type
Solenoid valves, 24 V DC						
	VC	2x 2/2-way valve, single solenoid, normally closed, pneumatic spring return	T22C	52 mm	8034967	VSVA-B-T22C-AZTR-D2-1T1L
	N	2x 3/2-way valve, single solenoid, normally open	T32U	52 mm	8034963	VSVA-B-T32U-AZTR-D2-1T1L
	K	2x 3/2-way valve, single solenoid, normally closed	T32C	52 mm	8034961	VSVA-B-T32C-AZTR-D2-1T1L
	H	2x 3/2-way valve, single solenoid, 1x normally open, 1x normally closed	T32H	52 mm	8034965	VSVA-B-T32H-AZTR-D2-1T1L
	P	2x 3/2-way valve, single solenoid, reverse operation, normally open	T32F	52 mm	8034964	VSVA-B-T32F-AZTR-D2-1T1L
	Q	2x 3/2-way valve, single solenoid, reverse operation, normally closed	T32N	52 mm	8034962	VSVA-B-T32N-AZTR-D2-1T1L
	R	2x 3/2-way valve, single solenoid, reverse operation, 1x normally open, 1x normally closed	T32W	52 mm	8034966	VSVA-B-T32W-AZTR-D2-1T1L
	M	5/2-way valve, single solenoid, pneumatic spring return	M52-A	52 mm	8034956	VSVA-B-M52-AZTR-D2-1T1L
	O	5/2-way valve, single solenoid, reset via mechanical spring	M52-M	52 mm	8034957	VSVA-B-M52-MZTR-D2-1T1L
	J	5/2-way valve, double solenoid	B52	52 mm	8034954	VSVA-B-B52-ZTR-D2-1T1L
	D	5/2-way valve, double solenoid, with dominant signal	D52	52 mm	8034955	VSVA-B-D52-ZTR-D2-1T1L
	B	5/3-way solenoid valve, Mid-position pressurised	P53U	52 mm	8034958	VSVA-B-P53U-ZTR-D2-1T1L
	G	5/3-way solenoid valve, mid-position closed	P53C	52 mm	8034960	VSVA-B-P53C-ZTR-D2-1T1L
	E	5/3-way solenoid valve, Mid-position exhausted	P53E	52 mm	8034959	VSVA-B-P53E-ZTR-D2-1T1L
	VG	5/3-way solenoid valve, mid-position pressurised 1 to 2, 4 to 5 closed	P53F	52 mm	8034968	VSVA-B-P53F-ZTR-D2-1T1L

Ordering data – Solenoid valve 24 V DC

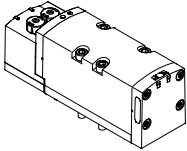
Ordering data – Solenoid valve VSVA with cover cap for MO, non-detenting (H)						
	Terminal code	Valve function	Valve code	Width	Part no.	Type
Solenoid valves, 24 V DC						
	VC	2x 2/2-way valve, single solenoid, normally closed, pneumatic spring return	T22C	52 mm	8034982	VSVA-B-T22C-AZH-D2-1T1L
	N	2x 3/2-way valve, single solenoid, normally open	T32U	52 mm	8034978	VSVA-B-T32U-AZH-D2-1T1L
	K	2x 3/2-way valve, single solenoid, normally closed	T32C	52 mm	8034976	VSVA-B-T32C-AZH-D2-1T1L
	H	2x 3/2-way valve, single solenoid, 1x normally open, 1x normally closed	T32H	52 mm	8034980	VSVA-B-T32H-AZH-D2-1T1L
	P	2x 3/2-way valve, single solenoid, reverse operation, normally open	T32F	52 mm	8034979	VSVA-B-T32F-AZH-D2-1T1L
	Q	2x 3/2-way valve, single solenoid, reverse operation, normally closed	T32N	52 mm	8034977	VSVA-B-T32N-AZH-D2-1T1L
	R	2x 3/2-way valve, single solenoid, reverse operation, 1x normally open, 1x normally closed	T32W	52 mm	8034981	VSVA-B-T32W-AZH-D2-1T1L
	M	5/2-way valve, single solenoid, pneumatic spring return	M52-A	52 mm	8034971	VSVA-B-M52-AZH-D2-1T1L
	O	5/2-way valve, single solenoid, reset via mechanical spring	M52-M	52 mm	8034972	VSVA-B-M52-MZH-D2-1T1L
	J	5/2-way valve, double solenoid	B52	52 mm	8034969	VSVA-B-B52-ZH-D2-1T1L
	D	5/2-way valve, double solenoid, with dominant signal	D52	52 mm	8034970	VSVA-B-D52-ZH-D2-1T1L
	B	5/3-way solenoid valve, Mid-position pressurised	P53U	52 mm	8034973	VSVA-B-P53U-ZH-D2-1T1L
	G	5/3-way solenoid valve, mid-position closed	P53C	52 mm	8034975	VSVA-B-P53C-ZH-D2-1T1L
	E	5/3-way solenoid valve, Mid-position exhausted	P53E	52 mm	8034974	VSVA-B-P53E-ZH-D2-1T1L
	VG	5/3-way solenoid valve, mid-position pressurised 1 to 2, 4 to 5 closed	P53F	52 mm	8034983	VSVA-B-P53F-ZH-D2-1T1L

Ordering data – Solenoid valve 24 V DC

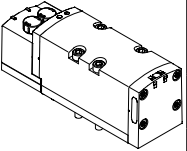
Ordering data – Solenoid valve VSVA with cover cap for MO, concealed						
	Terminal code	Valve function	Valve code	Width	Part no.	Type
Solenoid valves, 24 V DC						
	VC	2x 2/2-way valve, single solenoid, normally closed, pneumatic spring return	T22C	52 mm	8034997	VSVA-B-T22C-AZ-D2-1T1L
	N	2x 3/2-way valve, single solenoid, normally open	T32U	52 mm	8034993	VSVA-B-T32U-AZ-D2-1T1L
	K	2x 3/2-way valve, single solenoid, normally closed	T32C	52 mm	8034991	VSVA-B-T32C-AZ-D2-1T1L
	H	2x 3/2-way valve, single solenoid, 1x normally open, 1x normally closed	T32H	52 mm	8034995	VSVA-B-T32H-AZ-D2-1T1L
	P	2x 3/2-way valve, single solenoid, reverse operation, normally open	T32F	52 mm	8034994	VSVA-B-T32F-AZ-D2-1T1L
	Q	2x 3/2-way valve, single solenoid, reverse operation, normally closed	T32N	52 mm	8034992	VSVA-B-T32N-AZ-D2-1T1L
	R	2x 3/2-way valve, single solenoid, reverse operation, 1x normally open, 1x normally closed	T32W	52 mm	8034996	VSVA-B-T32W-AZ-D2-1T1L
	M	5/2-way valve, single solenoid, pneumatic spring return	M52-A	52 mm	8034986	VSVA-B-M52-AZ-D2-1T1L
	O	5/2-way valve, single solenoid, reset via mechanical spring	M52-M	52 mm	8034987	VSVA-B-M52-MZ-D2-1T1L
	J	5/2-way valve, double solenoid	B52	52 mm	8034984	VSVA-B-B52-Z-D2-1T1L
	D	5/2-way valve, double solenoid, with dominant signal	D52	52 mm	8034985	VSVA-B-D52-Z-D2-1T1L
	B	5/3-way solenoid valve, Mid-position pressurised	P53U	52 mm	8034988	VSVA-B-P53U-Z-D2-1T1L
	G	5/3-way solenoid valve, mid-position closed	P53C	52 mm	8034990	VSVA-B-P53C-Z-D2-1T1L
	E	5/3-way solenoid valve, Mid-position exhausted	P53E	52 mm	8034989	VSVA-B-P53E-Z-D2-1T1L
	VG	5/3-way solenoid valve, mid-position pressurised 1 to 2, 4 to 5 closed	P53F	52 mm	8034998	VSVA-B-P53F-Z-D2-1T1L

Ordering data – Solenoid valve 24 V DC – for VTSA-F-CB

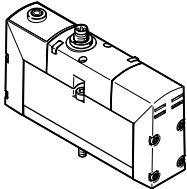
Ordering data – Solenoid valve VSVA with central plug, 3-pin, M12x1, round design						
	Terminal code	Valve function	Valve code	Width	Part no.	Type
Solenoid valves, 24 V DC						
	QN	2x 3/2-way valve, single solenoid, normally open	T32U	52 mm	567001	VSVA-B-T32U-AZD-D2-1R5L
	QK	2x 3/2-way valve, single solenoid, normally closed	T32C	52 mm	567000	VSVA-B-T32C-AZD-D2-1R5L
	QH	2x 3/2-way valve, single solenoid, 1x normally open, 1x normally closed	T32H	52 mm	567002	VSVA-B-T32H-AZD-D2-1R5L
	QM	5/2-way valve, single solenoid, pneumatic spring return	M52-A	52 mm	567003	VSVA-B-M52-AZD-D2-1R5L
	QO	5/2-way valve, single solenoid, reset via mechanical spring	M52-M	52 mm	567004	VSVA-B-M52-MZD-D2-1R5L
	QJ	5/2-way valve, double solenoid	B52	52 mm	567005	VSVA-B-B52-ZD-D2-1R5L
	QD	5/2-way valve, double solenoid, with dominant signal	D52	52 mm	567006	VSVA-B-D52-ZD-D2-1R5L
	QB	5/3-way solenoid valve, Mid-position pressurised	P53U	52 mm	567009	VSVA-B-P53U-ZD-D2-1R5L
	QG	5/3-way solenoid valve, mid-position closed	P53C	52 mm	567007	VSVA-B-P53C-ZD-D2-1R5L
	QE	5/3-way solenoid valve, Mid-position exhausted	P53E	52 mm	567008	VSVA-B-P53E-ZD-D2-1R5L

 **Note**

Additional information about solenoid valves with central plug can be found in the existing catalogue documentation at:
www.festo.com/catalogue/... → Support Portal:
 Standards-based valve VSVA to ISO 15407-1 and ISO 5599-1 with M8 or M12 central plug

Accessories – Pneumatic components

Ordering data – Manifold sub-base

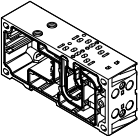
	Code	Description	Width	Part no.	Type
VTSA, port pattern to ISO 15407-2 and ISO 5599-2					
	A	2 valve positions, 4 addresses, for double solenoid valves	18 mm	539224	VABV-S4-2S-G18-2T2
	B	2 valve positions, 4 addresses, for double solenoid valves	26 mm	539220	VABV-S4-1S-G14-2T2
	YA	2 valve positions, 4 addresses, for double solenoid valves ¹⁾	18/26 mm	8068911	VABV-S4-12HS-G-CB-2T2
	C	1 valve position, 2 addresses, for double solenoid valves	42 mm	542458	VABV-S2-1S-G38-T2
	D	1 valve position, 2 addresses, for double solenoid valves	52 mm	560841	VABV-S2-2S-G12-T2
	E	2 valve positions, 2 addresses, for single solenoid valves	18 mm	539226	VABV-S4-2S-G18-2T1
	F	2 valve positions, 2 addresses, for single solenoid valves	26 mm	539222	VABV-S4-1S-G14-2T1
	G	1 valve position, 1 address, for single solenoid valves	42 mm	542459	VABV-S2-1S-G38-T1
H	1 valve position, 1 address, for single solenoid valves	52 mm	560842	VABV-S2-2S-G12-T1	

VTSA-F, optimised for flow rate

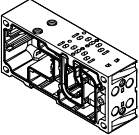
	A	2 valve positions, 4 addresses, for double solenoid valves	18 mm	546215	VABV-S4-2HS-G18-2T2
	B	2 valve positions, 4 addresses, for double solenoid valves	26 mm	546211	VABV-S4-1HS-G14-2T2
	XA	2 valve positions, 4 addresses, for double solenoid valves	18/26 mm	8190411	VABV-S4-12HS-G-2T2
	C	1 valve position, 2 addresses, for double solenoid valves	42 mm	546219	VABV-S2-1HS-G38-T2
	D	1 valve position, 2 addresses, for double solenoid valves	52 mm	560841	VABV-S2-2S-G12-T2
	E	2 valve positions, 2 addresses, for single solenoid valves	18 mm	546214	VABV-S4-2HS-G18-2T1
	F	2 valve positions, 2 addresses, for single solenoid valves	26 mm	546210	VABV-S4-1HS-G14-2T1
	G	1 valve position, 1 address, for single solenoid valves	42 mm	546218	VABV-S2-1HS-G38-T1
H	1 valve position, 1 address, for single solenoid valves	52 mm	560842	VABV-S2-2S-G12-T1	

VTSA-F-CB, with CBUS loop-through

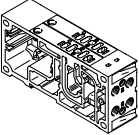
	A	2 valve positions, 4 addresses, for double solenoid valves ¹⁾	18 mm	8067932	VABV-S4-2HS-G18-CB-2T2
	B	2 valve positions, 4 addresses, for double solenoid valves ¹⁾	26 mm	8067940	VABV-S4-1HS-G14-CB-2T2
	C	1 valve position, 2 addresses, for double solenoid valves ¹⁾	42 mm	8068154	VABV-S2-1HS-G38-CB-2T2
	D	1 valve position, 2 addresses, for double solenoid valves ¹⁾	52 mm	8068146	VABV-S2-2S-G12-CB-2T2
	E	2 valve positions, 2 addresses, for single solenoid valves ¹⁾	18 mm	8067934	VABV-S4-2HS-G18-CB-2T1
	F	2 valve positions, 2 addresses, for single solenoid valves ¹⁾	26 mm	8067942	VABV-S4-1HS-G14-CB-2T1
	G	1 valve position, 1 address, for single solenoid valves ¹⁾	42 mm	8068156	VABV-S2-1HS-G38-CB-T1
	H	1 valve position, 1 address, for single solenoid valves ¹⁾	52 mm	8068148	VABV-S2-2S-G12-CB-T1

VTSA-F-CB, with CBUS loop-through for pilot air switching valve

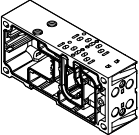
	YB	2 valve positions, for pilot air switching valve <ul style="list-style-type: none"> • 1 valve position, width 18 mm, with CBUS communication • 1 valve position, width 18 mm, double solenoid • Sensor evaluation: internal 	18 mm	8068913	VABV-S4-2HS-G18-CB-2T5
	YC	2 valve positions, for pilot air switching valve <ul style="list-style-type: none"> • 1 valve position, width 18 mm, with CBUS communication • 1 valve position, width 26 mm, double solenoid • Sensor evaluation: internal 	18/26 mm	8068912	VABV-S4-12HS-G-CB-2T5

VTSA-F-CB, with CBUS loop-through for soft-start valve

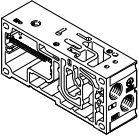
	PV	<ul style="list-style-type: none"> • With CBUS loop-through and new voltage zone • Pressure sensor plug-in • Sensor evaluation: internal (Ports 2 and 4 are combined), pneumatic connection G3/8, M5 	41 mm	8068609	VABV-S6-1Q-G38-CB1-T5
	PS	<ul style="list-style-type: none"> • With CBUS loop-through in the same voltage zone • Pressure sensor plug-in • Sensor evaluation: internal (Ports 2 and 4 are combined), pneumatic connection G3/8, M5 	41 mm	8068610	VABV-S6-1Q-G38-CB-T5

1) When using single solenoid valves on double solenoid sub-bases, one address will be lost!

Accessories – Pneumatic components

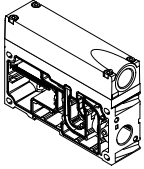
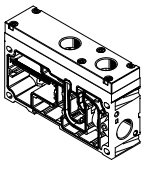
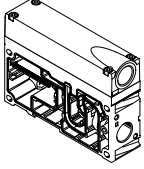
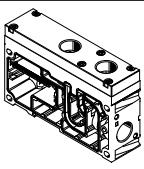
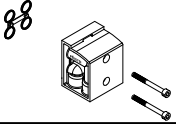
Ordering data – Supply plate/extension module						
	Code	Description	Width	Part no.	Type	
VTSA/VTSA-F, supply plate						
	L	With exhaust plate, 3/5 common, G1/2	38 mm	539231	VABF-S6-1-P1A7-G12	
	K	With exhaust air cover, 3/5 separated (for dual-pressure operation), G1/2	38 mm	539230	VABF-S6-1-P1A6-G12	
VTSA-F-CB, extension module, pneumatic and electric air supply plate						
	U	Additional air supply With exhaust plate, 3/5 common, G1/2	38 mm	8092506	VABF-S6-1-P1A7-G12-CB	
	UW	Additional pneumatic and electrical supply With exhaust plate, 3/5 common, G1/2 Generation of 24 additional valve addresses (electrical supply is provided internally from Uval)	38 mm	8104042	VABF-S6-1-P8A7-G12-CB	
	USW	Additional pneumatic and electrical supply With exhaust plate, 3/5 common, G1/2 Generation of 24 additional valve addresses (electrical supply is provided from new (safe) voltage zone (internally from S2))	38 mm	8104044	VABF-S6-1-P8A7-G12-CB1	
	U	Additional air supply With exhaust air cover, 3/5 separated (for dual-pressure operation), G1/2	38 mm	8092502	VABF-S6-1-P1A6-G12-CB	
	UW	Additional pneumatic and electrical supply With exhaust air cover, 3/5 separated (for dual-pressure operation), G1/2 Generation of 24 additional valve addresses (electrical supply is provided internally from Uval)	38 mm	8104041	VABF-S6-1-P8A6-G12-CB	
	USW	Additional pneumatic and electrical supply With exhaust air cover, 3/5 separated (for dual-pressure operation), G1/2 Generation of 24 additional valve addresses (electrical supply is provided from new (safe) voltage zone (internally from S2))	38 mm	8104043	VABF-S6-1-P8A6-G12-CB1	
90°-connection plate for VTSA/VTSA-F						
	P	Outlet underneath	Connecting thread G1/8	18 mm	539719	VABF-S4-2-A2G2-G18
			Connecting thread G1/4	26 mm	539721	VABF-S4-1-A2G2-G14
			Connecting thread G3/8	42 mm	546097	VABF-S2-1-A1G2-G38
			Connecting thread G1/2	52 mm	555702	VABF-S2-2-A1G2-G12

Accessories – Pneumatic components

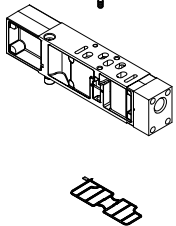
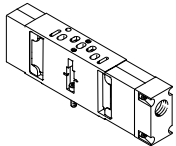
Ordering data – Vertical stacking						
	Code	Description		Width	Part no.	Type
Vertical supply plate						
	ZU	Individual compressed air supply, duct 1	Connecting thread G1/8	18 mm	540173	VABF-S4-2-P1A3-G18
			Connecting thread G1/4	26 mm	540171	VABF-S4-1-P1A3-G14
			Connecting thread G3/8	42 mm	546093	VABF-S2-1-P1A3-G38
			Connecting thread G1/2	52 mm	555786	VABF-S2-2-P1A3-G12
	ZV	Individual compressed air supply, ducts 1 and 14	Connecting thread G1/8	18 mm	8000693	VABF-S4-2-P1A14-G18
			Connecting thread G1/4	26 mm	8000689	VABF-S4-1-P1A14-G14
			Connecting thread G3/8	42 mm	8000536	VABF-S2-1-P1A14-G38
			Connecting thread G1/2	52 mm	8000549	VABF-S2-2-P1A14-G12
Vertical supply plate for valves with central plug, VTSA-F-CB						
	ZU	Individual compressed air supply, duct 1	Connecting thread G1/8	18 mm	544435	VABF-S3-2-P1A3-G18
			Connecting thread G1/4	26 mm	544434	VABF-S3-1-P1A3-G14
			Connecting thread G3/8	42 mm	549100	VABF-S1-1-P1A3-G38
			Connecting thread G1/2	52 mm	555785	VABF-S1-2-P1A3-G12

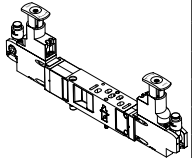
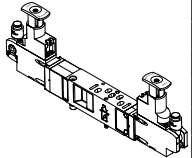
Ordering data – Vertical stacking							
	Code	Pressure regulation for port	Control range [bar]	[MPa]	Width	Part no.	Type
Regulator plate, width 18 mm							
	ZA	1	0.5 ... 8.5	0.05 ... 0.85	18 mm	540153	VABF-S4-2-R1C2-C-10
	ZF	1	0.5 ... 6	0.05 ... 0.6	18 mm	540151	VABF-S4-2-R1C2-C-6
	ZC	2	2 ... 8.5	0.2 ... 0.85	18 mm	540161	VABF-S4-2-R2C2-C-10
	ZH	2	2 ... 6	0.2 ... 0.6	18 mm	540159	VABF-S4-2-R2C2-C-6
	ZB	4	2 ... 8.5	0.2 ... 0.85	18 mm	540157	VABF-S4-2-R3C2-C-10
	ZG	4	2 ... 6	0.2 ... 0.6	18 mm	540155	VABF-S4-2-R3C2-C-6
	ZD	2 and 4	2 ... 8.5	0.2 ... 0.85	18 mm	540165	VABF-S4-2-R4C2-C-10
	ZI	2 and 4	2 ... 6	0.2 ... 0.6	18 mm	540163	VABF-S4-2-R4C2-C-6
	ZE	2 and 4, reversible	0.5 ... 8.5	0.05 ... 0.85	18 mm	540169	VABF-S4-2-R5C2-C-10
	ZJ	2 and 4, reversible	0.5 ... 6	0.05 ... 0.6	18 mm	540167	VABF-S4-2-R5C2-C-6
	ZL	2, reversible	0.5 ... 8.5	0.05 ... 0.85	18 mm	546252	VABF-S4-2-R6C2-C-10
	ZN	2, reversible	0.5 ... 6	0.05 ... 0.6	18 mm	546248	VABF-S4-2-R6C2-C-6
	ZK	4, reversible	0.5 ... 8.5	0.05 ... 0.85	18 mm	546254	VABF-S4-2-R7C2-C-10
	ZM	4, reversible	0.5 ... 6	0.05 ... 0.6	18 mm	546250	VABF-S4-2-R7C2-C-6
Regulator plate, width 26 mm							
	ZA	1	0.5 ... 8.5	0.05 ... 0.85	26 mm	540154	VABF-S4-1-R1C2-C-10
	ZF	1	0.5 ... 6	0.05 ... 0.6	26 mm	540152	VABF-S4-1-R1C2-C-6
	ZC	2	2 ... 8.5	0.2 ... 0.85	26 mm	540162	VABF-S4-1-R2C2-C-10
	ZH	2	2 ... 6	0.2 ... 0.6	26 mm	540160	VABF-S4-1-R2C2-C-6
	ZB	4	2 ... 8.5	0.2 ... 0.85	26 mm	540158	VABF-S4-1-R3C2-C-10
	ZG	4	2 ... 6	0.2 ... 0.6	26 mm	540156	VABF-S4-1-R3C2-C-6
	ZD	2 and 4	2 ... 8.5	0.2 ... 0.85	26 mm	540166	VABF-S4-1-R4C2-C-10
	ZI	2 and 4	2 ... 6	0.2 ... 0.6	26 mm	540164	VABF-S4-1-R4C2-C-6
	ZE	2 and 4, reversible	0.5 ... 8.5	0.05 ... 0.85	26 mm	540170	VABF-S4-1-R5C2-C-10
	ZJ	2 and 4, reversible	0.5 ... 6	0.05 ... 0.6	26 mm	540168	VABF-S4-1-R5C2-C-6
	ZL	2, reversible	0.5 ... 8.5	0.05 ... 0.85	26 mm	546251	VABF-S4-1-R6C2-C-10
	ZN	2, reversible	0.5 ... 6	0.05 ... 0.6	26 mm	546247	VABF-S4-1-R6C2-C-6
	ZK	4, reversible	0.5 ... 8.5	0.05 ... 0.85	26 mm	546253	VABF-S4-1-R7C2-C-10
	ZM	4, reversible	0.5 ... 6	0.05 ... 0.6	26 mm	546249	VABF-S4-1-R7C2-C-6

Accessories – Pneumatic components

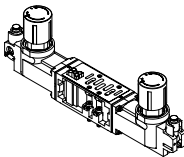
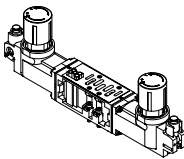
Ordering data – Vertical stacking							
	Code	Pressure regulation for port	Control range		Width	Part no.	Type
			[bar]	[MPa]			
Regulator plate, width 42 mm							
	ZA	1	0.5 ... 8.5	0.05 ... 0.85	42 mm	546084	VABF-S2-1-R1C2-C-10
	ZF	1	0.5 ... 6	0.05 ... 0.6	42 mm	546083	VABF-S2-1-R1C2-C-6
	ZC	2	1.0 ... 10	0.1 ... 1	42 mm	546088	VABF-S2-1-R2C2-C-10
	ZH	2	1.0 ... 6	0.1 ... 0.6	42 mm	546087	VABF-S2-1-R2C2-C-6
	ZB	4	1.0 ... 10	0.1 ... 1	42 mm	546086	VABF-S2-1-R3C2-C-10
	ZG	4	0.5 ... 6	0.05 ... 0.6	42 mm	546085	VABF-S2-1-R3C2-C-6
	ZD	2 and 4	1.0 ... 10	0.1 ... 1	42 mm	546090	VABF-S2-1-R4C2-C-10
	ZI	2 and 4	1.0 ... 6	0.1 ... 0.6	42 mm	546089	VABF-S2-1-R4C2-C-6
	ZE	2 and 4, reversible	0.5 ... 10	0.05 ... 1	42 mm	546092	VABF-S2-1-R5C2-C-10
	ZJ	2 and 4, reversible	0.5 ... 6	0.05 ... 0.6	42 mm	546091	VABF-S2-1-R5C2-C-6
	ZL	2, reversible	0.5 ... 10	0.05 ... 1	42 mm	546832	VABF-S2-1-R6C2-C-10
	ZN	2, reversible	0.5 ... 6	0.05 ... 0.6	42 mm	546831	VABF-S2-1-R6C2-C-6
	ZK	4, reversible	0.5 ... 10	0.05 ... 1	42 mm	546834	VABF-S2-1-R7C2-C-10
	ZM	4, reversible	0.5 ... 6	0.05 ... 0.6	42 mm	546833	VABF-S2-1-R7C2-C-6
Regulator plate, width 52 mm							
	ZA	1	0.5 ... 10	0.05 ... 1	52 mm	555772	VABF-S2-2-R1C2-C-10
	ZF	1	0.5 ... 6	0.05 ... 0.6	52 mm	555771	VABF-S2-2-R1C2-C-6
	ZC	2	1.0 ... 10	0.1 ... 1	52 mm	555774	VABF-S2-2-R2C2-C-10
	ZH	2	1.0 ... 6	0.1 ... 0.6	52 mm	555773	VABF-S2-2-R2C2-C-6
	ZB	4	1.0 ... 10	0.1 ... 1	52 mm	555776	VABF-S2-2-R3C2-C-10
	ZG	4	1.0 ... 6	0.1 ... 0.6	52 mm	555775	VABF-S2-2-R3C2-C-6
	ZD	2 and 4	1.0 ... 10	0.1 ... 1	52 mm	555778	VABF-S2-2-R4C2-C-10
	ZI	2 and 4	1.0 ... 6	0.1 ... 0.6	52 mm	555777	VABF-S2-2-R4C2-C-6
	ZE	2 and 4, reversible	0.5 ... 10	0.05 ... 1	52 mm	555780	VABF-S2-2-R5C2-C-10
	ZJ	2 and 4, reversible	0.5 ... 6	0.05 ... 0.6	52 mm	555779	VABF-S2-2-R5C2-C-6
	ZL	2, reversible	0.5 ... 10	0.05 ... 1	52 mm	555782	VABF-S2-2-R6C2-C-10
	ZN	2, reversible	0.5 ... 6	0.05 ... 0.6	52 mm	555781	VABF-S2-2-R6C2-C-6
	ZK	4, reversible	0.5 ... 10	0.05 ... 1	52 mm	555784	VABF-S2-2-R7C2-C-10
	ZM	4, reversible	0.5 ... 6	0.05 ... 0.6	52 mm	555783	VABF-S2-2-R7C2-C-6

Accessories – Pneumatic components

Ordering data – Vertical stacking

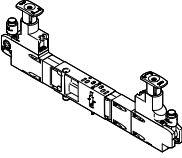
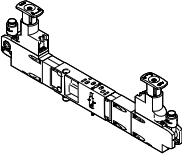
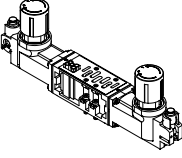
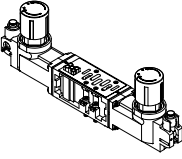
	Code	Pressure regulation for port	Control range		Width	Part no.	Type
			[bar]	[MPa]			
Regulator plate for valves with symmetrical design, width 18 mm							
	ZAY	1	0.5 ... 8.5	0.05 ... 0.85	18 mm	560756	VABF-S4-2-R1C2-C-10E
	ZFY	1	0.5 ... 6	0.05 ... 0.6	18 mm	560758	VABF-S4-2-R1C2-C-6E
	ZCY	2	2 ... 8.5	0.2 ... 0.85	18 mm	560763	VABF-S4-2-R2C2-C-10E
	ZHY	2	2 ... 6	0.2 ... 0.6	18 mm	560765	VABF-S4-2-R2C2-C-6E
	ZDY	2 and 4	2 ... 8.5	0.2 ... 0.85	18 mm	560767	VABF-S4-2-R4C2-C-10E
	ZIY	2 and 4	2 ... 6	0.2 ... 0.6	18 mm	560769	VABF-S4-2-R4C2-C-6E
	ZEY	2 and 4, reversible	0.5 ... 8.5	0.05 ... 0.85	18 mm	560771	VABF-S4-2-R5C2-C-10E
	ZJY	2 and 4, reversible	0.5 ... 6	0.05 ... 0.6	18 mm	560773	VABF-S4-2-R5C2-C-6E
	ZLY	2, reversible	0.5 ... 8.5	0.05 ... 0.85	18 mm	560775	VABF-S4-2-R6C2-C-10E
	ZNY	2, reversible	0.5 ... 6	0.05 ... 0.6	18 mm	560777	VABF-S4-2-R6C2-C-6E
Regulator plate for valves with symmetrical design, width 26 mm							
	ZAY	1	0.5 ... 8.5	0.05 ... 0.85	26 mm	560757	VABF-S4-1-R1C2-C-10E
	ZFY	1	0.5 ... 6	0.05 ... 0.6	26 mm	549876	VABF-S4-1-R1C2-C-6E
	ZCY	2	2 ... 8.5	0.2 ... 0.85	26 mm	560764	VABF-S4-1-R2C2-C-10E
	ZHY	2	2 ... 6	0.2 ... 0.6	26 mm	560766	VABF-S4-1-R2C2-C-6E
	ZDY	2 and 4	2 ... 8.5	0.2 ... 0.85	26 mm	560768	VABF-S4-1-R4C2-C-10E
	ZIY	2 and 4	2 ... 6	0.2 ... 0.6	26 mm	560770	VABF-S4-1-R4C2-C-6E
	ZEY	2 and 4, reversible	0.5 ... 8.5	0.05 ... 0.85	26 mm	560772	VABF-S4-1-R5C2-C-10E
	ZJY	2 and 4, reversible	0.5 ... 6	0.05 ... 0.6	26 mm	560774	VABF-S4-1-R5C2-C-6E
	ZLY	2, reversible	0.5 ... 8.5	0.05 ... 0.85	26 mm	560776	VABF-S4-1-R6C2-C-10E
	ZNY	2, reversible	0.5 ... 6	0.05 ... 0.6	26 mm	560778	VABF-S4-1-R6C2-C-6E
Regulator plate for valves with symmetrical design, width 42 mm ¹⁾							
	ZAY	1	0.5 ... 10	0.05 ... 1	42 mm	–	VABF-S2-1-R1C2-C-10E
	ZFY	1	0.5 ... 6	0.05 ... 0.6	42 mm	–	VABF-S2-1-R1C2-C-6E
	ZCY	2	0.5 ... 10	0.05 ... 1	42 mm	–	VABF-S2-1-R2C2-C-10E
	ZHY	2	0.5 ... 6	0.05 ... 0.6	42 mm	–	VABF-S2-1-R2C2-C-6E
	ZBY	4	0.5 ... 10	0.05 ... 1	42 mm	–	VABF-S2-1-R3C2-C-10E
	ZGY	4	0.5 ... 6	0.05 ... 0.6	42 mm	–	VABF-S2-1-R3C2-C-6E
	ZDY	2 and 4	0.5 ... 10	0.05 ... 1	42 mm	–	VABF-S2-1-R4C2-C-10E
	ZIY	2 and 4	0.5 ... 6	0.05 ... 0.6	42 mm	–	VABF-S2-1-R4C2-C-6E
	ZEY	2 and 4, reversible	0.5 ... 10	0.05 ... 1	42 mm	–	VABF-S2-1-R5C2-C-10E
	ZJY	2 and 4, reversible	0.5 ... 6	0.05 ... 0.6	42 mm	–	VABF-S2-1-R5C2-C-6E
	ZLY	2, reversible	0.5 ... 10	0.05 ... 1	42 mm	–	VABF-S2-1-R6C2-C-10E
	ZNY	2, reversible	0.5 ... 6	0.05 ... 0.6	42 mm	–	VABF-S2-1-R6C2-C-6E
	ZKY	4, reversible	0.5 ... 10	0.05 ... 1	42 mm	–	VABF-S2-1-R7C2-C-10E
	ZMY	4, reversible	0.5 ... 6	0.05 ... 0.6	42 mm	–	VABF-S2-1-R7C2-C-6E
	Regulator plate for valves with symmetrical design, width 52 mm ¹⁾						
	ZAY	1	0.5 ... 10	0.05 ... 1	52 mm	–	VABF-S2-2-R1C2-C-10E
	ZFY	1	0.5 ... 6	0.05 ... 0.6	52 mm	–	VABF-S2-2-R1C2-C-6E
	ZCY	2	0.5 ... 10	0.05 ... 1	52 mm	–	VABF-S2-2-R2C2-C-10E
	ZHY	2	0.5 ... 6	0.05 ... 0.6	52 mm	–	VABF-S2-2-R2C2-C-6E
	ZBY	4	0.5 ... 10	0.05 ... 1	52 mm	–	VABF-S2-2-R3C2-C-10E
	ZGY	4	0.5 ... 6	0.05 ... 0.6	52 mm	–	VABF-S2-2-R3C2-C-6E
	ZDY	2 and 4	0.5 ... 10	0.05 ... 1	52 mm	–	VABF-S2-2-R4C2-C-10E
	ZIY	2 and 4	0.5 ... 6	0.05 ... 0.6	52 mm	–	VABF-S2-2-R4C2-C-6E
	ZEY	2 and 4, reversible	0.5 ... 10	0.05 ... 1	52 mm	–	VABF-S2-2-R5C2-C-10E
	ZJY	2 and 4, reversible	0.5 ... 6	0.05 ... 0.6	52 mm	–	VABF-S2-2-R5C2-C-6E
	ZLY	2, reversible	0.5 ... 10	0.05 ... 1	52 mm	–	VABF-S2-2-R6C2-C-10E
	ZNY	2, reversible	0.5 ... 6	0.05 ... 0.6	52 mm	–	VABF-S2-2-R6C2-C-6E
	ZKY	4, reversible	0.5 ... 10	0.05 ... 1	52 mm	–	VABF-S2-2-R7C2-C-10E
	ZMY	4, reversible	0.5 ... 6	0.05 ... 0.6	52 mm	–	VABF-S2-2-R7C2-C-6E

1) These functions are only available via the pressure regulator configurator VABFS2 for width 42 mm and 52 mm only (ISO 5599-2, ISO 1 and ISO 2)

Accessories – Pneumatic components

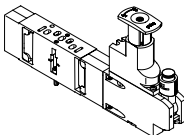
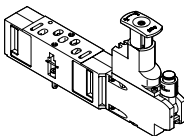
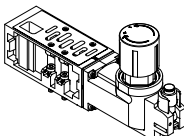
Ordering data – Vertical stacking for valves with central plug, VTSA-F-CB							
	Code	Pressure regulation for port	Control range		Width	Part no.	Type
			[bar]	[MPa]			
Regulator plate, width 18 mm							
	ZA	1	0.5 ... 8.5	0.05 ... 0.85	18 mm	543526	VABF-S3-2-R1C2-C-10
	ZF	1	0.5 ... 6	0.05 ... 0.6	18 mm	543524	VABF-S3-2-R1C2-C-6
	ZC	2	2 ... 8.5	0.2 ... 0.85	18 mm	543534	VABF-S3-2-R2C2-C-10
	ZH	2	2 ... 6	0.2 ... 0.6	18 mm	543532	VABF-S3-2-R2C2-C-6
	ZB	4	2 ... 8.5	0.2 ... 0.85	18 mm	543530	VABF-S3-2-R3C2-C-10
	ZG	4	2 ... 6	0.2 ... 0.6	18 mm	543528	VABF-S3-2-R3C2-C-6
	ZD	2 and 4	2 ... 8.5	0.2 ... 0.85	18 mm	543538	VABF-S3-2-R4C2-C-10
	ZI	2 and 4	2 ... 6	0.2 ... 0.6	18 mm	543536	VABF-S3-2-R4C2-C-6
	ZE	2 and 4, reversible	0.5 ... 8.5	0.05 ... 0.85	18 mm	543542	VABF-S3-2-R5C2-C-10
	ZJ	2 and 4, reversible	0.5 ... 6	0.05 ... 0.6	18 mm	543540	VABF-S3-2-R5C2-C-6
	ZL	2, reversible	0.5 ... 8.5	0.05 ... 0.85	18 mm	546788	VABF-S3-2-R6C2-C-10
	ZN	2, reversible	0.5 ... 6	0.05 ... 0.6	18 mm	546786	VABF-S3-2-R6C2-C-6
	ZK	4, reversible	0.5 ... 8.5	0.05 ... 0.85	18 mm	546792	VABF-S3-2-R7C2-C-10
	ZM	4, reversible	0.5 ... 6	0.05 ... 0.6	18 mm	546790	VABF-S3-2-R7C2-C-6
Regulator plate, width 26 mm							
	ZA	1	0.5 ... 8.5	0.05 ... 0.85	26 mm	543527	VABF-S3-1-R1C2-C-10
	ZF	1	0.5 ... 6	0.05 ... 0.6	26 mm	543525	VABF-S3-1-R1C2-C-6
	ZC	2	2 ... 8.5	0.2 ... 0.85	26 mm	543535	VABF-S3-1-R2C2-C-10
	ZH	2	2 ... 6	0.2 ... 0.6	26 mm	543533	VABF-S3-1-R2C2-C-6
	ZB	4	2 ... 8.5	0.2 ... 0.85	26 mm	543531	VABF-S3-1-R3C2-C-10
	ZG	4	2 ... 6	0.2 ... 0.6	26 mm	543529	VABF-S3-1-R3C2-C-6
	ZD	2 and 4	2 ... 8.5	0.2 ... 0.85	26 mm	543539	VABF-S3-1-R4C2-C-10
	ZI	2 and 4	2 ... 6	0.2 ... 0.6	26 mm	543537	VABF-S3-1-R4C2-C-6
	ZE	2 and 4, reversible	0.5 ... 8.5	0.05 ... 0.85	26 mm	543543	VABF-S3-1-R5C2-C-10
	ZJ	2 and 4, reversible	0.5 ... 6	0.05 ... 0.6	26 mm	543541	VABF-S3-1-R5C2-C-6
	ZL	2, reversible	0.5 ... 8.5	0.05 ... 0.85	26 mm	546789	VABF-S3-1-R6C2-C-10
	ZN	2, reversible	0.5 ... 6	0.05 ... 0.6	26 mm	546787	VABF-S3-1-R6C2-C-6
	ZK	4, reversible	0.5 ... 8.5	0.05 ... 0.85	26 mm	546793	VABF-S3-1-R7C2-C-10
	ZM	4, reversible	0.5 ... 6	0.05 ... 0.6	26 mm	546791	VABF-S3-1-R7C2-C-6
Regulator plate, width 42 mm							
	ZA	1	0.5 ... 10	0.05 ... 1	42 mm	546818	VABF-S1-1-R1C2-C-10
	ZF	1	0.5 ... 6	0.05 ... 0.6	42 mm	546817	VABF-S1-1-R1C2-C-6
	ZC	2	1.0 ... 10	0.1 ... 1	42 mm	546822	VABF-S1-1-R2C2-C-10
	ZH	2	1.0 ... 6	0.1 ... 0.6	42 mm	546821	VABF-S1-1-R2C2-C-6
	ZB	4	1.0 ... 10	0.1 ... 1	42 mm	546820	VABF-S1-1-R3C2-C-10
	ZG	4	0.5 ... 6	0.05 ... 0.6	42 mm	546819	VABF-S1-1-R3C2-C-6
	ZD	2 and 4	1.0 ... 10	0.1 ... 1	42 mm	546824	VABF-S1-1-R4C2-C-10
	ZI	2 and 4	1.0 ... 6	0.1 ... 0.6	42 mm	546823	VABF-S1-1-R4C2-C-6
	ZE	2 and 4, reversible	0.5 ... 10	0.05 ... 1	42 mm	546826	VABF-S1-1-R5C2-C-10
	ZJ	2 and 4, reversible	0.5 ... 6	0.05 ... 0.6	42 mm	546825	VABF-S1-1-R5C2-C-6
	ZL	2, reversible	0.5 ... 10	0.05 ... 1	42 mm	546828	VABF-S1-1-R6C2-C-10
	ZN	2, reversible	0.5 ... 6	0.05 ... 0.6	42 mm	546827	VABF-S1-1-R6C2-C-6
	ZK	4, reversible	0.5 ... 10	0.05 ... 1	42 mm	546830	VABF-S1-1-R7C2-C-10
	ZM	4, reversible	0.5 ... 6	0.05 ... 0.6	42 mm	546829	VABF-S1-1-R7C2-C-6

Accessories – Pneumatic components



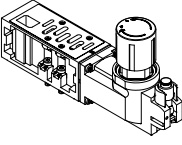

Ordering data – Vertical stacking for valves with central plug, VTSA-F-CB

	Code	Pressure regulation for port	Control range		Width	Part no.	Type
			[bar]	[MPa]			
Regulator plate, width 52 mm							
	ZA	1	0.5 ... 10	0.05 ... 1	52 mm	555758	VABF-S1-2-R1C2-C-10
	ZF	1	0.5 ... 6	0.05 ... 0.6	52 mm	555757	VABF-S1-2-R1C2-C-6
	ZC	2	1.0 ... 10	0.1 ... 1	52 mm	555760	VABF-S1-2-R2C2-C-10
	ZH	2	1.0 ... 6	0.1 ... 0.6	52 mm	555759	VABF-S1-2-R2C2-C-6
	ZB	4	1.0 ... 10	0.1 ... 1	52 mm	555762	VABF-S1-2-R3C2-C-10
	ZG	4	1.0 ... 6	0.1 ... 0.6	52 mm	555761	VABF-S1-2-R3C2-C-6
	ZD	2 and 4	1.0 ... 10	0.1 ... 1	52 mm	555764	VABF-S1-2-R4C2-C-10
	ZI	2 and 4	1.0 ... 6	0.1 ... 0.6	52 mm	555763	VABF-S1-2-R4C2-C-6
	ZE	2 and 4, reversible	0.5 ... 10	0.05 ... 1	52 mm	555766	VABF-S1-2-R5C2-C-10
	ZJ	2 and 4, reversible	0.5 ... 6	0.05 ... 0.6	52 mm	555765	VABF-S1-2-R5C2-C-6
	ZL	2, reversible	0.5 ... 10	0.05 ... 1	52 mm	555768	VABF-S1-2-R6C2-C-10
	ZN	2, reversible	0.5 ... 6	0.05 ... 0.6	52 mm	555767	VABF-S1-2-R6C2-C-6
	ZK	4, reversible	0.5 ... 10	0.05 ... 1	52 mm	555770	VABF-S1-2-R7C2-C-10
	ZM	4, reversible	0.5 ... 6	0.05 ... 0.6	52 mm	555769	VABF-S1-2-R7C2-C-6

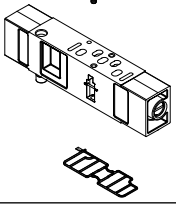
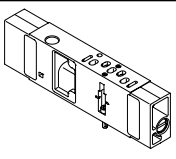
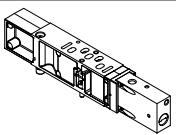
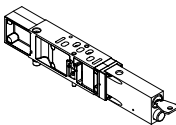
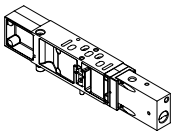
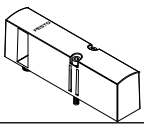

Ordering data

	Code	Description		Width	Part no.	Type
Pressure gauge						
	T	With cartridge connection for regulator, 10 bar	Scale in bar/psi, display range 0...16 bar/0...240 psi, for regulator plate code ZA, ZB, ZC, ZD, ZE, ZK, ZL	18 mm	543487	PAGN-26-16-P10
				26 mm		
				42 mm		
				52 mm		
	U	With cartridge connection for regulator, 6 bar,	Scale in bar/psi, display range 0...10 bar/0...145 psi, for regulator plate code ZF, ZG, ZH, ZI, ZJ, ZM, ZN	18 mm	543488	PAGN-26-10-P10
				26 mm		
				42 mm		
				52 mm		
	WT	With cartridge connection for regulator, 10 bar	Scale in MPa, display range 0...16 bar/0...1.6 MPa, for regulator plate code ZA, ZB, ZC, ZD, ZE, ZK, ZL	18 mm	563735	PAGN-26-1.6M-P10
				26 mm		
				42 mm		
				52 mm		
	WU	With cartridge connection for regulator, 6 bar	Scale in MPa, display range 0...16 bar/0...1 MPa for regulator plate code ZF, ZG, ZH, ZI, ZJ, ZM, ZN	18 mm	563736	PAGN-26-1M-P10
				26 mm		
42 mm						
52 mm						
VT	With cartridge connection for regulator, 10 bar	Scale in psi/bar, display range 0...16 bar/0...232 psi for regulator plate code ZA, ZB, ZC, ZD, ZE, ZK, ZL	18 mm	563731	PAGN-26-232P-P10	
			26 mm			
			42 mm			
			52 mm			
PS	With cartridge connection for regulator, 6 bar	Scale in psi/bar, display range 0...10 bar/0...145 psi for regulator plate code ZF, ZG, ZH, ZI, ZJ, ZM, ZN	18 mm	563732	PAGN-26-145P-P10	
			26 mm			
			42 mm			
			52 mm			
SGR	Red-green scale, with cartridge connection for regulator, 6 bar	Scale in bar, display range 0...10 bar	18 mm	8090378	PAGN-26-10-P10-RG	
			26 mm			

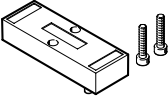

Accessories – Pneumatic components

Ordering data – Vertical stacking					
	Code	Description	Part no.	Type	
Cartridge for regulator plate					
	–	For tubing O.D. 4 mm	1 piece	172972	QSP10-4
	–	Adapter for pressure gauge (allows products with threaded connection G1/8 to be attached to the cartridge connection)	6 pieces	565811	QSP10-G1/8
Throttle plate					
	X	controls the flow of exhaust air downstream of the valve to ducts 3 and 5	18 mm	540176	VABF-S4-2-F1B1-C
			26 mm	540175	VABF-S4-1-F1B1-C
			42 mm	546095	VABF-S2-1-F1B1-C
			52 mm	555789	VABF-S2-2-F1B1-C
Throttle plate for valves with central plug, VTSA-F-CB					
	X	For port pattern to ISO 15407-2 and ISO 5599-2, controls the flow of exhaust air downstream of the valve to ducts 3 and 5	18 mm	543603	VABF-S3-2-F1B1-C
			26 mm	543604	VABF-S3-1-F1B1-C
			42 mm	549102	VABF-S1-1-F1B1-C
			52 mm	555788	VABF-S1-2-F1B1-C
Vertical pressure shut-off plate					
	ZT	3/2-way valve for shutting off the operating pressure at the valve position Pressure separation can be shut off on the valve assembly	18 mm	542884	VABF-S4-2-L1D1-C
			26 mm	542885	VABF-S4-1-L1D1-C
			42 mm	546096	VABF-S2-1-L1D1-C
			52 mm	555791	VABF-S2-2-L1D1-C
	ZS	3/2-way valve for shutting off the operating pressure at the valve position Pressure separation can be shut off on the valve assembly using a key	18 mm	8001178	VABF-S4-2-L1D2-C
			26 mm	8001179	VABF-S4-1-L1D2-C
Vertical pressure shut-off plate for valves with central plug, VTSA-F-CB					
	ZT	3/2-way valve for shutting off the operating pressure at the valve position Pressure separation can be shut off on the valve assembly	18 mm	543601	VABF-S3-2-L1D1-C
			26 mm	543602	VABF-S3-1-L1D1-C
			42 mm	549103	VABF-S1-1-L1D1-C
			52 mm	555790	VABF-S1-2-L1D1-C
Covering					
	L	Cover plate for vacant position	18 mm	539213	VABB-S4-2-WT
			26 mm	539212	VABB-S4-1-WT
			42 mm	543186	VABB-S2-1-WT
			52 mm	560845	VABB-S2-2-WT
	–	Sealing cap for electrical links (with individual connection), size 18 mm and 26 mm	10 pieces	547713	VABD-S4-E-C
	–	Seal (with individual connection), Width 42 mm and 52 mm	2 pieces	571343	VABD-S2-1-S-C

Accessories – Pneumatic components

Ordering data – Accessories for valves with central plug, VTSA-F-CB				
	Description		Part no.	Type
	Cover plate to seal spare or vacant valve positions	18 mm	161114	NDV-02-VDMA
		26 mm	161107	NDV-01-VDMA
	Sealing cap for electrical links (with individual connection), size 18 mm and 26 mm	10 pieces	547713	VABD-S4-E-C
	Seal (with individual connection), Width 42 mm and 52 mm	2 pieces	571343	VABD-S2-1-S-C

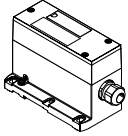
Accessories – Electric components

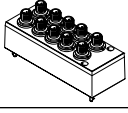
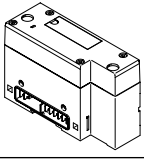
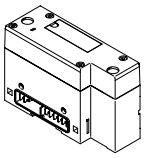
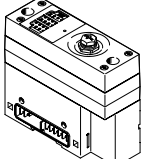
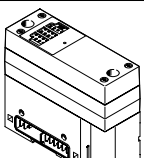
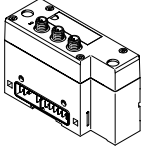
Ordering data		Code	Description	Width	Part no.	Type
Multi-pin node for VTSA/VTSA-F						
	T	Terminal strip, 36-pin	 Note Multi-pin node supplied without cover. Please order appropriate cover with cable separately.	–	543412	VABE-S6-1LF-C-M1-C36M
	MP1	Sub-D plug, 37-pin		–	543414	VABE-S6-1LT-C-M1-S37
	MP4	Round plug, 19-pin		–	543415	VABE-S6-1LF-C-M1-R19
Individual electrical connection for VTSA/VTSA-F						
	MP2	Multi-pin node with individual connection M12, 6-way	–	549046	VABE-S6-1T-C-S6-R5	
	MP3	Multi-pin node with individual connection M12, 10-way	–	549047	VABE-S6-1T-C-S10-R5	
	–	Cover for individual connection M12, 6-way	–	549048	VAEM-S6-C-S6-R5	
	–	Cover for individual connection M12, 10-way	–	549049	VAEM-S6-C-S10-R5	
Pneumatic interface for VTSA/VTSA-F						
	–	For electrical terminal CPX in polymer	50 mm	543416	VABA-S6-1-X1	
	–	For electrical terminal CPX in metal	50 mm	550663	VABA-S6-1-X2	
	–	For electrical terminal CPX in metal, with changed diagnostic function	50 mm	573613	VABA-S6-1-X2-D	
Pneumatic interface for VTSA-F-CB						
	RA	For electrical terminal CPX in polymer	50 mm	8082877	VABA-S6-1-X1-CB	
		For electrical terminal CPX in metal	50 mm	8082876	VABA-S6-1-X2-CB	
	RD	For electrical terminal CPX (interface for PROFIsafe only) in metal with	50 mm	8068241	VABA-S6-1-X2-F2-CB	
	RC	For electrical terminal CPX (interface for PROFIsafe only) in metal with	50 mm	8068240	VABA-S6-1-X2-F1-CB	
	RB	For electrical terminal CPX (interface for fieldbus only) in polymer	50 mm	8082879	VABA-S6-1-X1-3V-CB	
	RB	For electrical terminal CPX (interface for fieldbus only) in metal	50 mm	8082878	VABA-S6-1-X2-3V-CB	

Accessories – Electric components

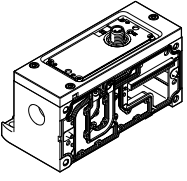
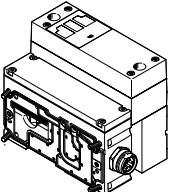
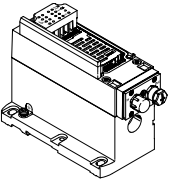
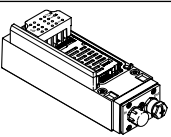
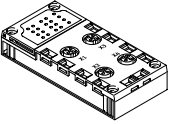
Ordering data		Code	Description	Part no.	Type
Electrical interface IO-Link					
	–		Interfaz IO-Link, for 16 valve positions	8152353	VABA-S6-1-PT
Pneumatic interface for VTSA-F-CB					
	XB		CPX pneumatic interface with adapter plate on left, for expansion with 3 external power supplies for the zones	8152438	VABA-S6-1-X2-3V-CB-AL
	XC		CPX pneumatic interface with adapter plate on left, for expansion with 3 safe internal zones (PROFIsafe)	8152437	VABA-S6-1-X2-F1-CB-AL
	XD		CPX pneumatic interface with adapter plate on left, for expansion with 2 safe internal zones + 1 safe output (PROFIsafe)	8152436	VABA-S6-1-X2-F2-CB-AL
	PC		CPX pneumatic interface with adapter plate on left and additional power supply, for expansion with 3 safe internal zones (PROFIsafe)	8152435	VABA-S6-1-X2-F1-CB2-AL
	PD		CPX pneumatic interface with adapter plate on left and additional power supply, for extension with 2 safe internal zones + 1 safe output (PROFIsafe)	8152434	VABA-S6-1-X2-F2-CB2-AL
Electrical interface for AS-Interface for VTSA/VTSA-F					
	–		4 inputs/4 outputs	549042	VABE-S6-1LF-C-A4-E
	–		8 inputs/8 outputs	549043	VABE-S6-1LF-C-A8-E
AS-Interface module for VTSA/VTSA-F					
	–		4 inputs/4 outputs	549044	VAEM-S6-S-FAS-4-4E
	–		8 inputs/8 outputs	549045	VAEM-S6-S-FAS-8-8E
Connection block for AS-Interface for VTSA/VTSA-F					
	X		4x M12, 5-pin, double, socket	195704	CPX-AB-4-M12x2-5POL
	GW		4x M12, 5-pin, socket, metal thread	541254	CPX-AB-4-M12x2-5POL-R
	R		8x M8, 3-pin, socket	195706	CPX-AB-8-M8-3POL
	J		8x spring-loaded terminal, Cage Clamp®, 4-pin	195708	CPX-AB-8-KL-4POL
	B		Sub-D, 25-pin, socket	525676	CPX-AB-1-SUB-BU-25POL

Accessories – Electric components

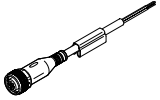
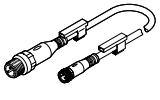
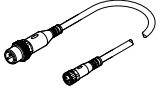
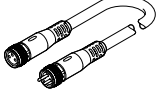
Ordering data	Description	Part no.	Type
Connecting cable for electrical connection of individual valves with central plug, VSTA-F-CB			
	<ul style="list-style-type: none"> • Straight socket, 1xM12, 5-pin • Open end, 4-core 	5 m	541328 NEBU-M12G5-K-5-LE4
	<ul style="list-style-type: none"> • Straight socket, 1xM8, 3-pin • Straight plug 1xM12, 3-pin • With 2x inscription label holders 	0.5 m	8000209 NEBU-M8G3-K-0.5-M12G3
	<ul style="list-style-type: none"> • Straight socket, 1xM8, 3-pin • Straight plug 1xM12, 3-pin • Without inscription label holder 	1 m	8091512 NEBU-M8G3-K-1-N-M12G3
	Modular system for a choice of connecting cables	–	NEBU-... → Internet: nebu



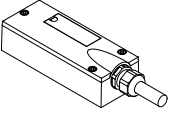
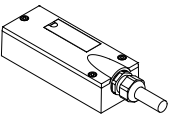
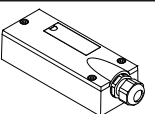

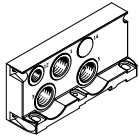
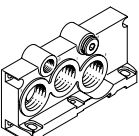
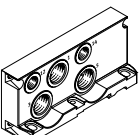
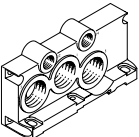
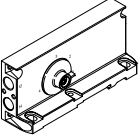
Accessories – General



Ordering data					
	Code	Description	Part no.	Type	
Connecting cable, Sub-D (TPE-U(PUR), IP65)					
	GA	Connecting cable for max. 8 solenoid coils, 10-core	2.5 m	539240	NEBV-S1W37-E-2.5-LE10
	GB		5 m	539241	NEBV-S1W37-E-5-LE10
	GC		10 m	539242	NEBV-S1W37-E-10-LE10
	GD	Connecting cable for max. 22 solenoid coils, 26-core	2.5 m	539243	NEBV-S1W37-E-2.5-LE26
	GE		5 m	539244	NEBV-S1W37-E-5-LE26
	GF		10 m	539245	NEBV-S1W37-E-10-LE26
	GG	Connecting cable for max. 32 solenoid coils, 37-core	2.5 m	539246	NEBV-S1W37-K-2.5-LE37
	GH		5 m	539247	NEBV-S1W37-K-5-LE37
	GI		10 m	539248	NEBV-S1W37-K-10-LE37
Connecting cable, Sub-D (PVC, IP65)					
	GK	Connecting cable for max. 8 solenoid coils, 10-core	2.5 m	543271	NEBV-S1W37-KM-2.5-LE10
	GL		5 m	543272	NEBV-S1W37-KM-5-LE10
	GM		10 m	543273	NEBV-S1W37-KM-10-LE10
	GN	Connecting cable for max. 23 solenoid coils, 27-core	2.5 m	543274	NEBV-S1W37-KM-2.5-LE27
	GO		5 m	543275	NEBV-S1W37-KM-5-LE27
	GP		10 m	543276	NEBV-S1W37-KM-10-LE27
	GQ	Connecting cable for max. 32 solenoid coils, 37-core	2.5 m	543277	NEBV-S1W37-KM-2.5-LE37
	GR		5 m	543278	NEBV-S1W37-KM-5-LE37
	GS		10 m	543279	NEBV-S1W37-KM-10-LE37
Cover for multi-pin plug for VTSA/VTSA-F					
	-	For configuration by the user	545974	NECV-S1W37	

Ordering data – End plates				
	Code	Description	Part no.	Type
Right, with threaded connection				
	V	With working air/exhaust air, internal pilot air supply, G1/2 (no port 14)	539234	VABE-S6-1R-G12
	V1	With working air/exhaust air, internal pilot air supply, G3/4 (port 14 is sealed with a blanking plug)	560837	VABE-S6-2R-G34
	X	With working air/exhaust air, external pilot air supply, G1/2	539236	VABE-S6-1RZ-G12
	X1	With working air/exhaust air, external pilot air supply, G3/4	560839	VABE-S6-2RZ-G34
With pilot air selector				
	Y ¹⁾	Internal pilot air supply	539238	VABE-S6-1RZ-G-B1
	U ¹⁾	Internal pilot air supply, ducted pilot exhaust air		
	Z ¹⁾	External pilot air supply		
	W ¹⁾	External pilot air supply, ducted pilot exhaust air		

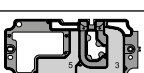
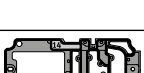
1) Code letter within the order code for a valve terminal configuration

Accessories – General



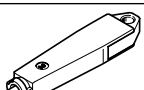





Ordering data – Duct separation/seal					
	Code	Description	Weight	Part no.	Type
	S	Duct separation 1, 3, 5	57 g	539228	VABD-S6-1-P3-C
	T	Duct separation 1	43 g	539227	VABD-S6-1-P1-C
	R	Duct separation 3, 5	54 g	539229	VABD-S6-1-P2-C
	L	Seal between sub-bases, duct 1, 3, 5 open, port 14 blocked (colour coding: white)	40 g	573191	VABD-S6-1-P7-C
	TL	Seal between sub-bases, duct 1 blocked, port 14 blocked (colour coding: red) Note: additional pilot air supply required	43 g	8060483	VABD-S6-1-P8-C
	K	Seal between sub-bases, duct 1, 3, 5 blocked, port 14 blocked (colour coding: green)	57 g	8034612	VABD-S6-1-P6-C

Ordering data					
	Code	Description		Part no.	Type
Cover caps					
	N	Cover cap for manual override, non-detenting	10 pieces	541010	VAMC-S6-CH
	V	Cover cap for manual override, concealed	10 pieces	541011	VAMC-S6-CS
	A	Cover cap, heavy duty, for manual override, non-detenting heavy duty, detenting via accessory (key) (The cover cap is provided for one-off mounting only)	10 pieces	4105147	VAMC-B-S6-CTR
Accessories for manual override, heavy duty					
	–	Coded key (accessory) for actuating the cover cap, heavy duty, for detenting position (VAMC-B-S6-CTR)	1 piece	1662543	AHB-MEB-B

 **Note**

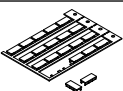
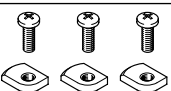
There is a wide range of preconfigured solenoid valves with cover cap for manual override and correct valve type code available to order in the sections on solenoid valves.

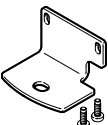
Accessories – General

Ordering data		Code	Description	Part no.	Type
Inscription label holders/inscription labels					
	B	Clip-on inscription label holder for valve cap	5 pieces	540888	ASCF-T-S6
	BZ	Clip-on inscription label holder for valve cap with additional text fields (electrical and pneumatic zone separation)	4 pieces	8106532	ASCF-T-S6-Z
	T	Inscription label holder for manifold blocks/manifold sub-bases VTSA/VTSA-F	5 pieces	540889	ASCF-M-S6
	TD	Inscription label holder for manifold blocks/manifold sub-bases VTSA/VTSA-F, size 52 mm	5 pieces	562577	ASCF-M-S2-2
		Identification clip for manifold blocks/manifold sub-bases VTSA-F-CB (code A, B, C, E, F, G, PV, PS)		8110689	ASCF-M-S6-1
	-	Inscription label for ISO 15407 valves with individual electrical connection (20 labels in frames)	20 pieces	18182	IBS-9x20
	-	Inscription label for pressure zone separation • 4 inscription labels, duct 1/3/5 blocked • 4 inscription labels, duct 1 blocked • 4 inscription labels, duct 3/5 blocked	3x4 pieces	8003303	ASLR-L-S6-2016
H-rail mounting					
	-	VTSA and VTSA-F	3 pieces	526032	CPX-CPA-BG-NRH
Wall mounting					
	-	Mounting bracket with a mounting hole for M5 screw	5 pieces	539214	VAME-S6-10-W
	U	Mounting bracket with a mounting hole for M4 screw and a mounting hole for M6 screw	1 piece	567038	VAME-S6-W-M46
	AW	Mounting bracket for length compensation on the CPX side when mounting using support system Set comprising 1 angle bracket and 2 screws	1 piece	2721419	CPX-M-BG-VT-2X
User documentation					
	D	User documentation for valve terminal VTSA/VTSA-F	German	538922	VTSA/VTSA-F-DE
	E		English	538923	VTSA/VTSA-F-EN
	S		Spanish	538924	VTSA/VTSA-F-ES
	F		French	538925	VTSA/VTSA-F-FR
	I		Italian	538926	VTSA/VTSA-F-IT
Pneumatic connection accessories					
<p>A selection of possible fittings, blanking plugs, silencers and other pneumatic accessories can be found in the chapter Accessories → page 246 or on the website via the individual search terms:</p> <p>Internet → connection technology, silencer, blanking plug</p>					

Datasheet – Solenoid valve with switching position sensing

Function1)

Valves with code SO, SQ, SS,
width 18 mm

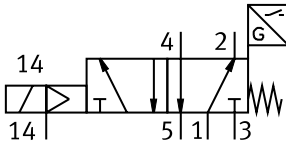

Valves with code SO, SQ, SS,
width 26 mm

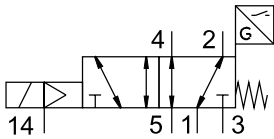

- - Flow rate
up to 1100 l/min

- - Valve width
18 mm
26 mm

- - Voltage
24 V DC

- - Operating pressure
3 ... 10 bar
0.3 ... 1 MPa

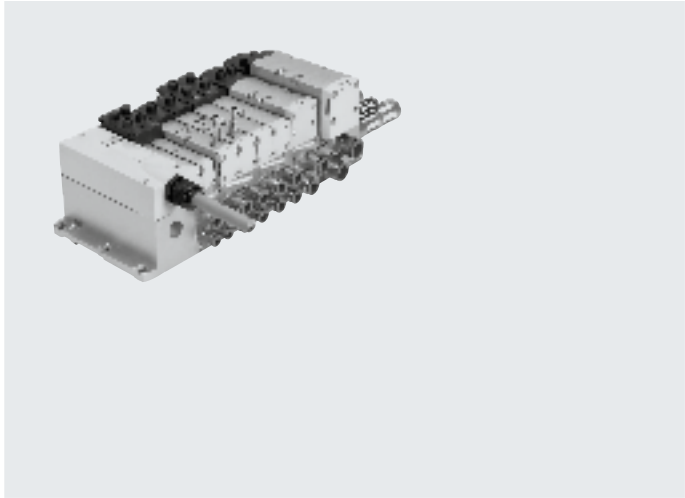

ISO valves with switching position sensing for safety-related pneumatic components

Function

The single solenoid 5/2-way valve with spring return in width 18 mm and 26 mm features valve diagnostics. It is available as a valve with plug-in or individual connection with pilot valves to ISO 15218 and square plug type C.

The normal position of the piston spool is monitored by the inductive sensor. This valve is not a safety device in accordance with the Machinery Directive 2006/42/EC. When used in higher categories, the sensor signal from the valve must be evaluated by the control system.

This valve is suitable for use in safety-related parts of control systems to EN ISO 13849-1. The control block has been developed and manufactured in accordance with the basic and proven safety principles of EN ISO 13849-2.

This valve is designed for installation in machines and automation systems and must only be used in industrial applications (high-demand mode).

Decentralised individual connection variant

Valve on individual sub-base (square plug or plug-in) with integrated switching position sensing.

The electrical connection is established via either a standardised 4-pin M12 plug 24 V DC (ISO 15407-2), a 4-pin spring-loaded terminal or a cable (open end) 24 V DC, which can be configured by the user.

The individual sub-base can be supplied with internal or external pilot air depending on the version.

Variant for valve terminal VTSA/VTSA-F

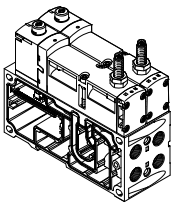

The valves with integrated switching position sensing in plug-in design for valve terminal VTSA/VTSA-F/VTSA-F-CB can be used regardless of the type of electrical actuation (individual, multi-pin plug or fieldbus/control block connection).

Pilot air supply:
The valve terminal can be supplied with internal or external pilot air via the various end plate variants.

Note
Valves in plug-in design are always supplied with pilot air via duct 14 in the manifold sub-base.

1) The circuit symbol represents a valve with a proximity switch with a N/O switching output signal. In accordance with ISO 1219-1, this symbol is used for both N/O and N/C. The switching element function of the sensors used here is designed as an N/C contact.

Note
Pilot exhaust air port 12 is exhausted directly at the valve, without a connection. If the customer requests a "turned seal", exhaust air is vented at the end plates of the valve terminal, which doesn't conform to the ISO standard.

Datasheet – Solenoid valve with switching position sensing

Safety characteristics	
Conforms to	EN 13849-1/2
CE marking (see declaration of conformity)	To EU EMC Directive ¹⁾
Shock resistance	Shock test with severity level 2, to EN 60068-2-27
Vibration resistance	Transport application test with severity level 2, to EN 60068-2-6

1) For information about the area of use, see the EC declaration of conformity at: www.festo.com/sp → Certificates.

If the devices are subject to usage restrictions in residential, commercial or light-industrial environments, further measures for the reduction of the emitted interference may be necessary.

Safety characteristics		
Valve function 5/2-way, single solenoid	Test pulses	
	Max. positive test pulse with logic 0 [µs]	Max. negative test pulse with logic 1 [µs]
VSVA-B-M52-MZ...A1-1T1L- ...	1200	1100
VSVA-B-M52-MZ...A2-1T1L- ...	1500	800
VSVA-B-M52-MZ-A1-1C1- ...	1800	800

General technical data			
Valve	VSVA-B-M52-MZD-A2-1T1L-...	VSVA-B-M52-MZD-A1-1T1L-...	VSVA-B-M52-MZ-A1-1C1-...
Width	18 mm	26 mm	26 mm
Conforms to	ISO 15407-2		ISO 15407-1
Design	Piston spool valve		
Sealing principle	Soft		
Actuation type	Electrical		
Type of actuation	Piloted		
Exhaust function, can be throttled	Via individual sub-base, via throttle plate		
Lubrication	Lifetime lubrication		
Type of mounting	Via through-hole, on manifold sub-base		
Mounting position	Any		
Manual override	Concealed		
Individual sub-base			→ Page 232
Valve terminal			→ Page 84

Standard nominal flow rate [l/min]				
Valve function	Flow rate			
	Valve	Valve on valve terminal VTSA	Valve on valve terminal VTSA-F	Valve on individual sub-base
VSVA-B-M52-M...A1-1C1-ANC	1400	1100	–	1100
VSVA-B-M52-M...A1-1C1-ANP	1400	1100	–	1100
VSVA-B-M52-M...A1-1C1-APC	1400	1100	–	1100
VSVA-B-M52-M...A1-1C1-APP	1400	1100	–	1100
VSVA-B-M52-M...A1-1T1L-ANC	1400	1100	1350	1200
VSVA-B-M52-M...A1-1T1L-ANP	1400	1100	1350	1200
VSVA-B-M52-M...A1-1T1L-APC	1400	1100	1350	1200
VSVA-B-M52-M...A1-1T1L-APP	1400	1100	1350	1200
VSVA-B-M52-M...A1-1T1L-APX-0.5	1400	1100	1350	1200
VSVA-B-M52-M...A2-1T1L-ANP	750	550	700	600
VSVA-B-M52-M...A2-1T1L-APP	750	550	700	600
VSVA-B-M52-M...A2-1T1L-APX-0.5	750	550	700	600

Datasheet – Solenoid valve with switching position sensing

Valve switching times [ms]		VSVA-B-M52-MZD-A2-1T1L...	VSVA-B-M52-MZD-A1-1T1L...	VSVA-B-M52-MZ-A1-1C1...
Valve				
Width		18 mm	26 mm	26 mm
Valve switching times	On	12	20	21
	Off	38	54	41
Sensor switching times	On	32	60	60
	Off	9	11	11

Electrical data for valve		VSVA-B-M52-MZD-A2-1T1L...	VSVA-B-M52-MZD-A1-1T1L...	VSVA-B-M52-MZ-A1-1C1...
Valve				
Width		18 mm	26 mm	26 mm
Electrical connection		4-pin plug to ISO 15407-2		Plug to EN 175301-803, type C, without PE conductor
Nominal operating voltage	[V DC]	24		
Permissible voltage fluctuations	[%]	±10		-15/+10
Surge resistance	[kV]	2.5		
Pollution degree		3		
Power consumption	[W]	1.6		1.8
Switching position sensing		Normal position via sensor		
Duty cycle	[%]	100		
Degree of protection to EN 60529		IP65, NEMA 4 (for all types of signal transmission when mounted)		
Signal status display		LED		Via accessories

Electrical data for sensor		
Electrical connection		Cable, 3-core 1xM8 plug, 3-pin
Cable length	[m]	2.5
Switching output		PNP or NPN
Switching element function		N/C
Switching status indication		Yellow LED
Operating voltage range	[V DC]	10 ... 30
Residual ripple	[%]	±10
Sensor no-load supply current	[mA]	≤10
Max. output current	[mA]	200
Voltage drop	[V]	≤2
Max. switching frequency	[Hz]	5000
Short circuit current rating		Clocked
Reverse polarity protection for sensor		For all electrical connections
Measuring principle		Inductive
Switching position sensing		Valve normal position via sensor

Datasheet – Solenoid valve with switching position sensing

Operating and environmental conditions		
Valve	VSVA-B-M52-...-1T1L-...	VSVA-B-M52-...-1C1-...
Operating medium	Compressed air to ISO 8573-1:2010 [7:4:4]	
Notes on operating/ Pilot medium	Lubricated operation possible (in which case lubricated operation will always be required)	
Operating pressure	[bar]	-0.9 ... 10
	[MPa]	-0.09 ... 1
Operating pressure for valve terminal with internal pilot air supply	[bar]	3 ... 10
	[MPa]	0.3 ... 1
Pilot pressure	[bar]	3 ... 10
	[MPa]	0.3 ... 1
Ambient temperature	[°C]	-5 ... +50
Temperature of medium	[°C]	-5 ... +50
Note on materials	RoHS-compliant	
Noise level LpA	[dB(A)]	85
CE marking (see declaration of conformity)	To EU EMC Directive ¹⁾	
UKCA marking (see declaration of conformity)	To UK instructions for EMC ¹⁾	
KC marking	KC EMC	
Certification	C-Tick	C-Tick
	c UL us - Recognized (OL)	-

1) For information about the area of use, see the EC declaration of conformity at: www.festo.com/catalogue/... → Support/Downloads.
If the devices are subject to usage restrictions in residential, commercial or light-industrial environments, further measures for the reduction of the emitted interference may be necessary.

Materials	
Sub-base/manifold sub-base	Die-cast aluminium
Valve	Die-cast aluminium, PA
Seals	FPM, NBR
Screws	Galvanised steel
Sensor housing	High-alloy stainless steel
Sensor cable sheath	TPE-U(PUR)

Product weight [g]		
Width	18 mm	26 mm
5/2-way solenoid valve type		
VSVA-B-M52-M...-A2-1T1L-APX-0.5	157	-
VSVA-B-M52-M...-A2-1T1L-APP	140	-
VSVA-B-M52-M...-A2-1T1L-ANP	140	-
VSVA-B-M52-M...-A1-1T1L-APC	-	307
VSVA-B-M52-M...-A1-1T1L-APP	-	264
VSVA-B-M52-M...-A1-1C1-APC	-	332
VSVA-B-M52-M...-A1-1C1-APP	-	289
VSVA-B-M52-M...-A1-1T1L-ANC	-	307
VSVA-B-M52-M...-A1-1T1L-ANP	-	264
VSVA-B-M52-M...-A1-1C1-ANC	-	332
VSVA-B-M52-M...-A1-1C1-ANP	-	289
VSVA-B-M52-M...-A1-1T1L-APX-0.5	-	281
Individual connection		
Individual sub-base	192	302

Datasheet – Solenoid valve with switching position sensing

Dimensions

Solenoid valve with sensor, width 26 mm

Download CAD data → www.festo.com

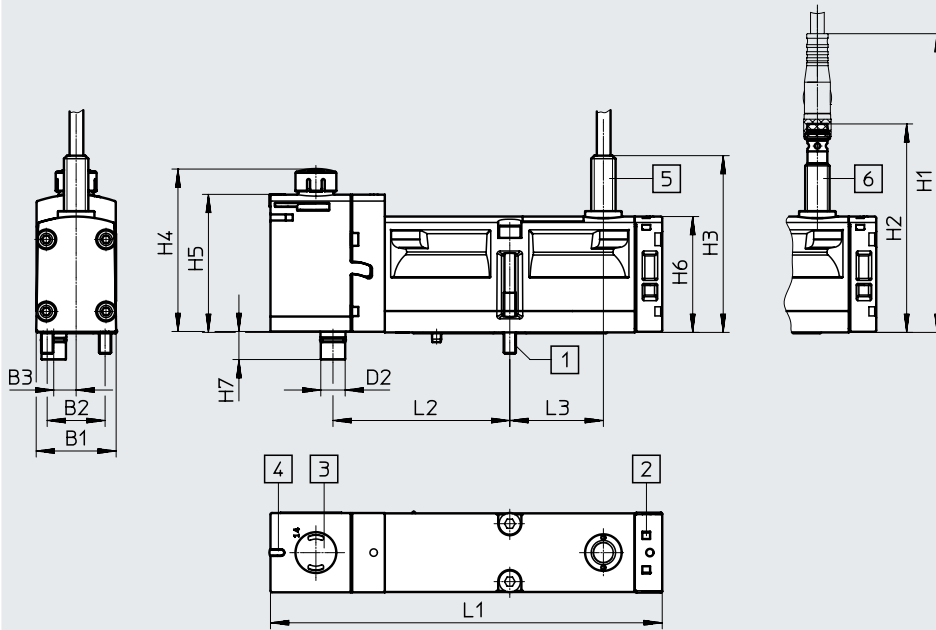

- [1] Captive socket head screw M4x38
- [2] Space for inscription label
- [3] Manual override
- [4] Light emitting diode
- [5] Sensor with connecting cable
- [6] Sensor with plug

Type	B1	B2	B3	D2	L1	L2	L3
VSVA-B-M52-MZD-A1-1T1L-...	26.2	19	7.4	8	128.9	58	30.7
VSVA-B-M52-MZD-A1-1T1L-APX-0.5							

Type	H1	H2	H3	H4	H5	H6	H7
VSVA-B-M52-MZD-A1-1T1L-...	98	68.2	58	52.5	45.3	38	9.2
VSVA-B-M52-MZD-A1-1T1L-APX-0.5							

Datasheet – Solenoid valve with switching position sensing

Dimensions

Download CAD data → www.festo.com

Solenoid valve with sensor, with plug type C, width 26 mm

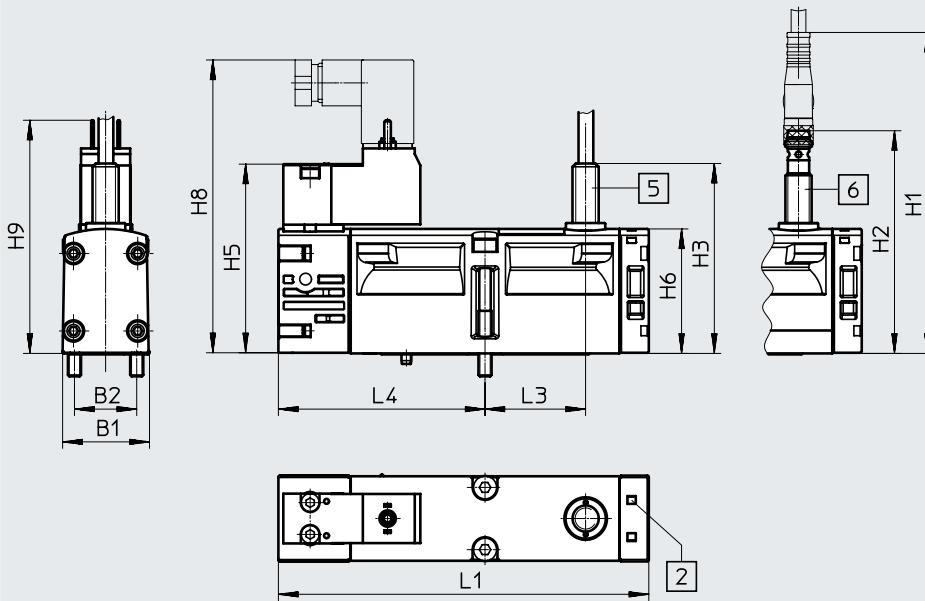

- [1] Captive socket head screw M4x38
- [2] Space for inscription label
- [5] Sensor with connecting cable
- [6] Sensor with plug

Type	B1	B2	L1	L3	L4
VSVA-B-M52-MZ-A1-1C1-...	26.2	19	113.1	30.7	63.1

Type	H1	H2	H3	H5	H6	H8	H9
VSVA-B-M52-MZ-A1-1C1-...	98	68.2	58	57.8	38	89.6	71.2

Ordering data – Solenoid valve with switching position sensing

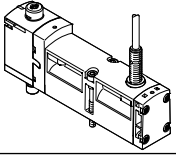
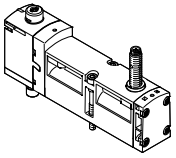
Ordering data – Solenoid valve VSVA, MO non-detenting/detenting (D)					
	Code	Valve function	Width	Part no.	Type
5/2-way solenoid valve, 24 V DC, plug-in design for valve terminal VTSA/VTSA-F with proximity switch					
	–	5/2-way valve, single solenoid, mechanical spring return, inductive sensor with PNP output and cable, 3-core, 2.5 m	26 mm	560723	VSVA-B-M52-MZD-A1-1T1L-APC
	–	5/2-way valve, single solenoid, mechanical spring return, inductive sensor with NPN output and cable, 3-core, 2.5 m	26 mm	560742	VSVA-B-M52-MZD-A1-1T1L-ANC
	SS	5/2-way valve, single solenoid, mechanical spring return, inductive sensor with PNP output with 0.5 m connecting cable and 4-pin sensor push-in connector M12x1	18 mm	573201	VSVA-B-M52-MZD-A2-1T1L-APX-0.5
			26 mm	570850	VSVA-B-M52-MZD-A1-1T1L-APX-0.5
	SO	5/2-way valve, single solenoid, mechanical spring return, inductive sensor with PNP output and 3-pin sensor push-in connector M8x1	18 mm	573202	VSVA-B-M52-MZD-A2-1T1L-APP
			26 mm	560724	VSVA-B-M52-MZD-A1-1T1L-APP
SQ	5/2-way valve, single solenoid, mechanical spring return, inductive sensor with NPN output and 3-pin sensor push-in connector M8x1	18 mm	573203	VSVA-B-M52-MZD-A2-1T1L-ANP	
			26 mm	560743	VSVA-B-M52-MZD-A1-1T1L-ANP

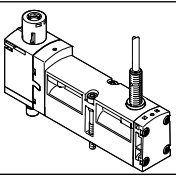
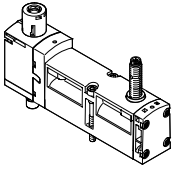
Ordering data – Solenoid valve VSVA with cover cap for MO non-detenting/heavy duty, detenting via accessory (TR)					
	Code	Valve function	Width	Part no.	Type
5/2-way solenoid valve, 24 V DC, plug-in design for valve terminal VTSA/VTSA-F with proximity switch					
	–	5/2-way valve, single solenoid, mechanical spring return, inductive sensor with PNP output and cable, 3-core, 2.5 m	26 mm	8033026	VSVA-B-M52-MZTR-A1-1T1L-APC
	–	5/2-way valve, single solenoid, mechanical spring return, inductive sensor with NPN output and cable, 3-core, 2.5 m	26 mm	8033030	VSVA-B-M52-MZTR-A1-1T1L-ANC
	SS	5/2-way valve, single solenoid, mechanical spring return, inductive sensor with PNP output with 0.5 m connecting cable and 4-pin sensor push-in connector M12x1	18 mm	8033459	VSVA-B-M52-MZTR-A2-1T1L-APX-0.5
			26 mm	8033034	VSVA-B-M52-MZTR-A1-1T1L-APX-0.5
	SO	5/2-way valve, single solenoid, mechanical spring return, inductive sensor with PNP output and 3-pin sensor push-in connector M8x1	18 mm	8033460	VSVA-B-M52-MZTR-A2-1T1L-APP
			26 mm	8033027	VSVA-B-M52-MZTR-A1-1T1L-APP
SQ	5/2-way valve, single solenoid, mechanical spring return, inductive sensor with NPN output and 3-pin sensor push-in connector M8x1	18 mm	8033461	VSVA-B-M52-MZTR-A2-1T1L-ANP	
			26 mm	8033031	VSVA-B-M52-MZTR-A1-1T1L-ANP

Ordering data – Solenoid valve with switching position sensing

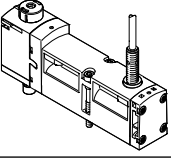
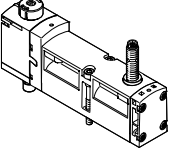
Ordering data – Solenoid valve VSVA with cover cap for MO, non-detenting (H)					
	Code	Valve function	Width	Part no.	Type
5/2-way solenoid valve, 24 V DC, plug-in design for valve terminal VTSA/VTSA-F with proximity switch					
	–	5/2-way valve, single solenoid, mechanical spring return, inductive sensor with PNP output and cable, 3-core, 2.5 m	26 mm	8033049	VSVA-B-M52-MZH-A1-1T1L-APC
	–	5/2-way valve, single solenoid, mechanical spring return, inductive sensor with NPN output and cable, 3-core, 2.5 m	26 mm	8033053	VSVA-B-M52-MZH-A1-1T1L-ANC
	SS	5/2-way valve, single solenoid, mechanical spring return, inductive sensor with PNP output with 0.5 m connecting cable and 4-pin sensor push-in connector M12x1	18 mm	8033477	VSVA-B-M52-MZH-A2-1T1L-APX-0.5
			26 mm	8033057	VSVA-B-M52-MZH-A1-1T1L-APX-0.5
	SO	5/2-way valve, single solenoid, mechanical spring return, inductive sensor with PNP output and 3-pin sensor push-in connector M8x1	18 mm	8033478	VSVA-B-M52-MZH-A2-1T1L-APP
			26 mm	8033050	VSVA-B-M52-MZH-A1-1T1L-APP
	SQ	5/2-way valve, single solenoid, mechanical spring return, inductive sensor with NPN output and 3-pin sensor push-in connector M8x1	18 mm	8033479	VSVA-B-M52-MZH-A2-1T1L-ANP
			26 mm	8033054	VSVA-B-M52-MZH-A1-1T1L-ANP

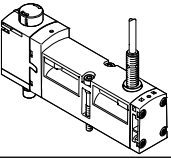
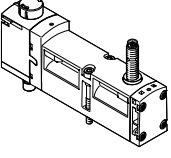
Ordering data – Solenoid valve VSVA with cover cap for MO, concealed					
	Code	Valve function	Width	Part no.	Type
5/2-way solenoid valve, 24 V DC, plug-in design for valve terminal VTSA/VTSA-F with proximity switch					
	–	5/2-way valve, single solenoid, mechanical spring return, inductive sensor with PNP output and cable, 3-core, 2.5 m	26 mm	8033072	VSVA-B-M52-MZ-A1-1T1L-APC
	–	5/2-way valve, single solenoid, mechanical spring return, inductive sensor with NPN output and cable, 3-core, 2.5 m	26 mm	8033076	VSVA-B-M52-MZ-A1-1T1L-ANC
	SS	5/2-way valve, single solenoid, mechanical spring return, inductive sensor with PNP output with 0.5 m connecting cable and 4-pin sensor push-in connector M12x1	18 mm	8033495	VSVA-B-M52-MZ-A2-1T1L-APX-0.5
			26 mm	8033080	VSVA-B-M52-MZ-A1-1T1L-APX-0.5
	SO	5/2-way valve, single solenoid, mechanical spring return, inductive sensor with PNP output and 3-pin sensor push-in connector M8x1	18 mm	8033496	VSVA-B-M52-MZ-A2-1T1L-APP
			26 mm	8033073	VSVA-B-M52-MZ-A1-1T1L-APP
	SQ	5/2-way valve, single solenoid, mechanical spring return, inductive sensor with NPN output and 3-pin sensor push-in connector M8x1	18 mm	8033497	VSVA-B-M52-MZ-A2-1T1L-ANP
			26 mm	8033077	VSVA-B-M52-MZ-A1-1T1L-ANP

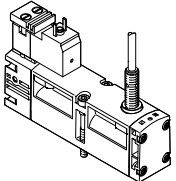
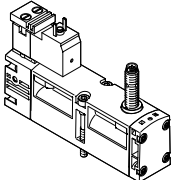

Ordering data – Solenoid valve with switching position sensing

Ordering data	Code	Valve function	Width	Part no.	Type
Solenoid valves, 24 V DC, with pneumatic interface to ISO 15218 for individual sub-base					
	–	5/2-way valve, single solenoid, mechanical spring return, inductive sensor with PNP output and cable, 3-core, 2.5 m, electrical connection to EN 175301-803, type C	26 mm	560725	VSVA-B-M52-MZ-A1-1C1-APC
	–	5/2-way valve, single solenoid, mechanical spring return, inductive sensor with NPN output and cable, 3-core, 2.5 m, electrical connection to EN 175301-803, type C	26 mm	560744	VSVA-B-M52-MZ-A1-1C1-ANC
	–	5/2-way valve, single solenoid, mechanical spring return, inductive sensor with PNP output and 3-pin sensor push-in connector M8x1, electrical connection to EN 175301-803, type C	26 mm	560726	VSVA-B-M52-MZ-A1-1C1-APP
	–	5/2-way valve, single solenoid, mechanical spring return, inductive sensor with NPN output and 3-pin sensor push-in connector M8x1, electrical connection to EN 175301-803, type C	26 mm	560745	VSVA-B-M52-MZ-A1-1C1-ANP

 **Note**

- The sensors integrated in the valves must not be replaced by the customer. Incorrect assembly can result in malfunctions or damage to the valve. Return the module to Festo for repair in the event of a fault.
- Valves with switching position sensing from the VSVA-B-M52-... series can only be ordered individually. If these are used on a valve terminal, appropriate vacant positions must be provided for them. Exceptions are the valves with ident. code SS, SO and SQ.

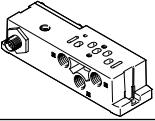
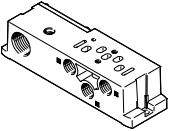

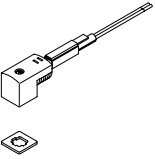
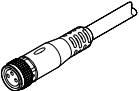
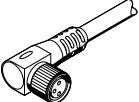
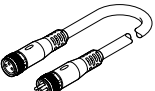

Accessories – Solenoid valve with switching position sensing

Ordering data		Code	Description	Part no.	Type	
Individual sub-base, port pattern to ISO 15407-2, electrical connection via plug M12						
	-	Threaded connection, internal pilot air supply, lateral connections	G1/8	18 mm	541070	VABS-S4-2S-G18-B-R3
			G1/4	26 mm	541069	VABS-S4-1S-G14-B-R3
	-	Threaded connection, external pilot air supply, lateral connections	G1/8	18 mm	541064	VABS-S4-2S-G18-R3
			G1/4	26 mm	541063	VABS-S4-1S-G14-R3
Individual sub-base, port pattern to ISO 15407-2, electrical connection via cable terminals						
	-	Threaded connection, internal pilot air supply, lateral connections	G1/8	18 mm	541067	VABS-S4-2S-G18-B-K2
			G1/4	26 mm	541065	VABS-S4-1S-G14-B-K2
	-	Threaded connection, external pilot air supply, lateral connections	G1/8	18 mm	539723	VABS-S4-2S-G18-K2
			G1/4	26 mm	539725	VABS-S4-1S-G14-K2
Plug socket for the electrical connection of individual valves, type C						
	-	<ul style="list-style-type: none"> • Angled socket, type C, 3-pin • Straight plug, PG7 • 230 V AC 			151687	MSSD-EB
			<ul style="list-style-type: none"> • Angled socket, type C, 3-pin • Straight plug, M12x1 			539712
Illuminating seal for connection pattern to EN 175301-803, type C						
	-	For plug socket MSSD, 12 ... 24 V DC			151717	MEB-LD-12-24DC
					Datasheet → Internet: meb-ld	

Ordering data		Code	Description	Part no.	Type
Connecting cable for electrical connection of individual valves, type C					
	GG	<ul style="list-style-type: none"> • Angled socket, type C, 3-pin, with LED • Open end, 3-core • 24 V DC, PVC 	2.5 m	151688	KMEB-1-24-2.5-LED
	GH		5 m	151689	KMEB-1-24-5-LED
	GJ		10 m	193457	KMEB-1-24-10-LED
Connecting cable for the electrical connection of sensors for switching position sensing					
	GM	<ul style="list-style-type: none"> • Straight socket, 1xM8, 3-pin • Open end, 3-core 	2.5 m	541333	NEBU-M8G3-K-2.5-LE3
	GN		5 m	541334	NEBU-M8G3-K-5-LE3
	GO	<ul style="list-style-type: none"> • Angled socket, 1xM8, 3-pin • Open end, 3-core 	2.5 m	541338	NEBU-M8W3-K-2.5-LE3
	GP		5 m	541341	NEBU-M8W3-K-5-LE3
	-		2.5 m	8001660	NEBU-M8R3-K-2.5-LE3
	-		5 m	8001661	NEBU-M8R3-K-5-LE3
	GQ	<ul style="list-style-type: none"> • Straight socket, 1xM8, 3-pin • Straight plug 1xM8, 4-pin 	2.5 m	554037	NEBU-M8G3-K-2.5-M8G4
	-		Modular system for a choice of connecting cables	-	-

Pneumatic connection accessories
 A selection of possible fittings, blanking plugs, silencers and other pneumatic accessories can be found in the chapter **Accessories** → page: 246 or on the website via the individual search terms:
Internet → connection technology, silencer, blanking plug

Datasheet – Control block with safety function for VTSA/VTSA-F

-  - Flow rate
on valve terminal: 830 l/min
-  - Solenoid valve width
26 mm
-  - Voltage
24 V DC
-  - Operating pressure
3 ... 10 bar
0.3 ... 1 MPa

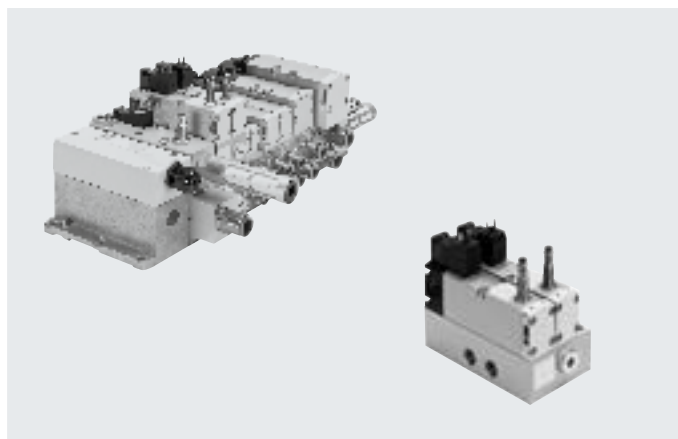

Description

The control block is designed for two-channel control of pneumatic drive components such as double-acting linear cylinders and can be used to realise the following protective measures:

- Protection against unexpected start-up (EN 1037)
- Reversing hazardous movements, provided the reversing motion will not result in further hazards

Version for valve terminal VTSA/VTSA-F

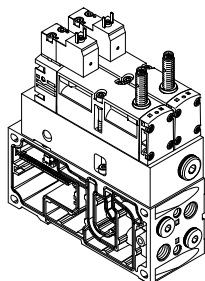

The control attributes of the control block enable Performance Level e to be achieved for the protective measures. The control block has been developed and manufactured in accordance with the basic and proven safety principles of EN ISO 13849-1 and EN ISO 13849-2.

The valves with integrated switching position sensing on manifold sub-base for valve terminal VTSA/VTSA-F need to be supplied with power regardless of the type of electrical actuation (individual, multi-pin plug or fieldbus/control block connection).

The requirements of EN ISO 13849-1 and EN ISO 13849-2 (e.g. CCF, DC) must be taken into consideration when installing and operating the component and when using it in higher categories (2 to 4). When using this product in machines or systems subject to specific C standards, the requirements specified in these standards must be observed.

The electrical connection for the solenoid valves is established separately via a standardised square plug to EN 175301-803, type C. The switching position sensing of the inductive PNP or NPN proximity switch is via a push-in connector size M8x1 to EN 61076-2-104.

The control block with safety function is designed for installation in machines and automation systems and must only be used in industrial applications (high-demand mode)! The control block with safety function is suitable for use as a press safety valve to EN 962.

More information and technical data
→ Internet: User documentation

- - Note

The control block with safety function (VOFA) is also available as a decentralised individual connection variant with electrical and pneumatic individual connection.

For information see:

→ Internet: vofa

- - Note

The appropriate manifold sub-base VABV-S4- ..., which is required for integration into the valve terminal, is not part of the control block. It is automatically allocated by the configurator when the control block is selected.

Datasheet – Control block with safety function for VTSA/VTSA-F

Pneumatic/electrical links

Function

The safety function is achieved by linking two pneumatic ducts of two 5/2-way single solenoid valves within the control block: port (4) is only pressurised if both solenoid valves are switched to the switching position (14).

Port (2) is always supplied with compressed air if at least one of the two solenoid valves is in normal position.

The valves are reset via a mechanical spring.

The switching operation of the solenoid valves can be sensed using the proximity switches on the solenoid valves (switching position sensing).

By connecting the control signal and the switching signal of the proximity switch it is possible to check if the piston spools of the solenoid valves have reached or left the normal position (expectations).

The piston spools of the solenoid valves are designed to prevent pneumatic short circuits between the ports (2) and (4) are prevented (positive overlap).

The two solenoid valves must be actuated via two separate ducts to achieve the required category 4 (Performance Level e, to EN ISO 13849-1).

Circuit symbol¹⁾

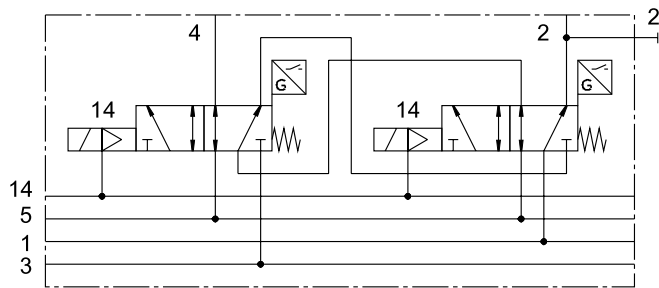

For the control block with safety function VOFA-B26-T52-... for the valve terminal, two 5/2-way solenoid valves of width 26 mm are pneumatically linked via two ducts, using an intermediate plate as vertical stacking element (output 2 is switched in parallel, output 4 is switched in series).

1) The circuit symbol represents a valve with a proximity switch with a N/O switching output signal. In accordance with ISO 1219-1, this symbol applies to both N/O and N/C contacts. The switching element function of the sensors used here is designed as an N/C contact.

Safety characteristics

Conforms to	EN 13849-1
Safety function	Protection against manipulation, prevention of unexpected start-up Reversing a movement
Performance level (PL)	Protection against manipulation, prevention of unexpected start-up/up to category 4, Performance Level e Reversing a movement/up to category 4, Performance Level e
Note on forced checking procedure	Switching frequency min. 1/week
Certificate-issuing authority	IFA 1001179
CE marking (see declaration of conformity)	To EU EMC Directive ¹⁾ To EU Machinery Directive
Max. positive test pulse with logic 0	[s] 1000
Max. negative test pulse with logic 1	[s] 800
Shock resistance	Shock test with severity level 2, to EN 60068-2-27
Vibration resistance	Transport application test with severity level 2, to EN 60068-2-6

1) For information about the area of use, see the EC declaration of conformity at: www.festo.com/catalogue/... → Support/Downloads.

If the devices are subject to usage restrictions in residential, commercial or light-industrial environments, further measures for the reduction of the emitted interference may be necessary.

Datasheet – Control block with safety function for VTSA/VTSA-F

Peripherals overview

Connection option for control block with safety function via PROFIsafe shut-off module CPX-FVDA-P2 (safety module)

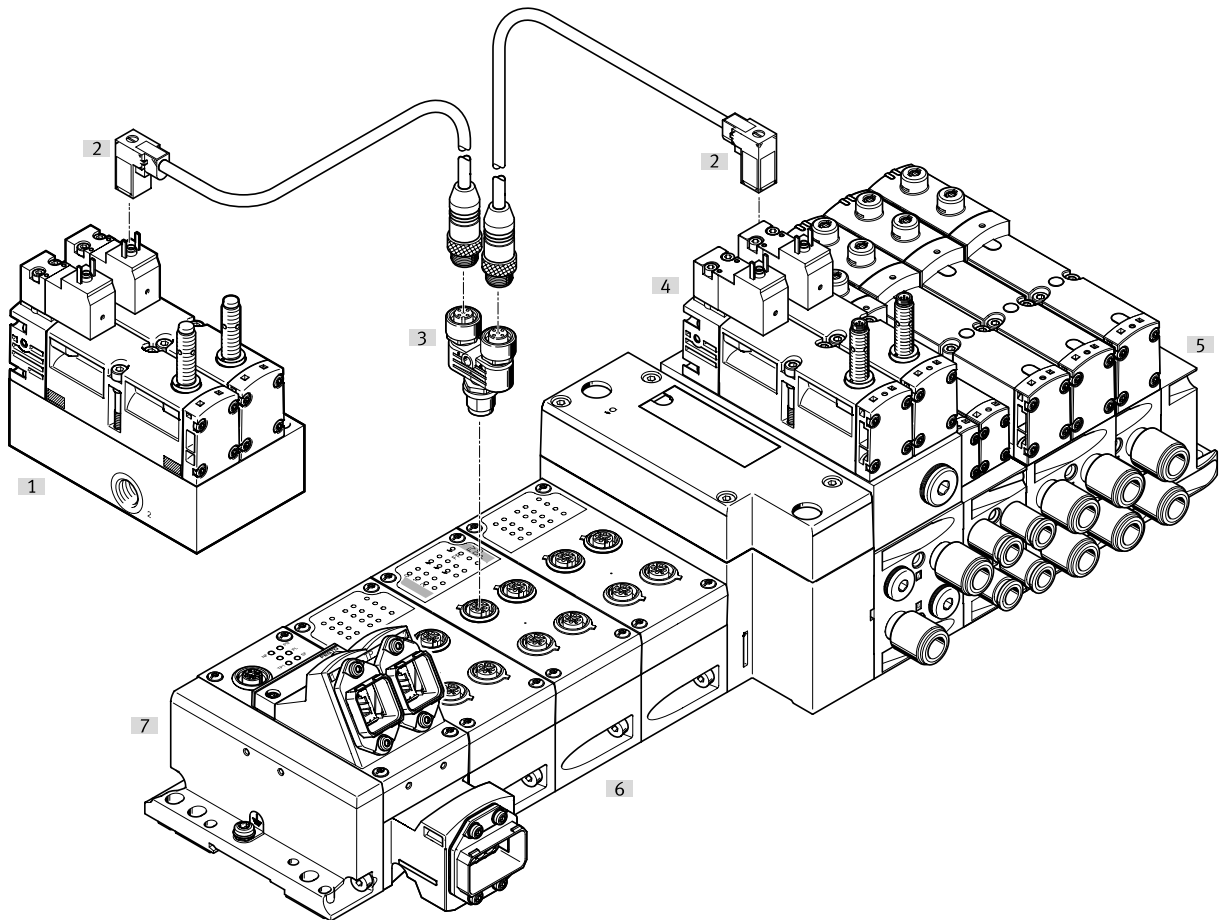

Peripherals overview		Description	→ Page/Internet
[1]	Control block with safety function	Away from the valve terminal as a decentralised individual connection variant	vofa
[2]	Connecting cable KMEB-...	For electrical connection of the control block with safety function via PROFIsafe shut-off module CPX-FV-DA-P2 (safety module)	kmeb
[3]	Push-in T-connector NEDU-...	For simultaneously actuating two valves, e.g. control block with safety function	nedu
[4]	Control block with safety function	Integrated in the pneumatic section of the valve terminal VTSA/VTSA-F	-
[5]	Pneumatic section of the valve terminal VTSA/VTSA-F	Pneumatic components of the valve terminal VTSA/VTSA-F	-
[6]	CPX-FVDA-P2 (safety module)	PROFIsafe shut-off module integrated in the CPX terminal of the valve terminal VTSA/VTSA-F	cpx
[7]	CPX terminal of the valve terminal VTSA/VTSA-F	Electric components of the valve terminal VTSA/VTSA-F	-

Datasheet – Control block with safety function for VTSA/VTSA-F

General technical data		
Design		Piston spool valve
Standard nominal flow rate	[l/min]	830
Reset method		Mechanical spring
Sealing principle		Soft
Exhaust function		Can be throttled
Actuation type		Electrical
Overlap		Positive overlap
Type of actuation		Piloted
Flow direction		Not reversible
Exhaust function		Can be throttled
Suitable for vacuum		–
Nominal width	[mm]	9
Pilot air supply		Via valve terminal
Type of mounting		Via through-hole, on manifold sub-base
Mounting position		Any
Manual override		–
Signal status display, valve		With accessories
Pneumatic connections		
Supply	1	Via the manifold sub-base of the valve terminal
Exhausting	3/5	
Working ports	2/4	
Pilot air supply	14	
Pressure gauge		G1/4
Operating and environmental conditions		
Operating medium		Compressed air to ISO 8573-1:2010 [7:4:4]
Pilot medium		Compressed air to ISO 8573-1:2010 [7:4:4]
Notes on operating/ Pilot medium		Lubricated operation possible (in which case lubricated operation will always be required)
Operating pressure	[bar]	0 ... 10
	[MPa]	0 ... 1
Operating pressure for valve terminal with internal pilot air supply	[bar]	3 ... 10
	[MPa]	0.3 ... 1
Pilot pressure	[bar]	3 ... 10
	[MPa]	0.3 ... 1
Noise level LpA	[dB(A)]	85
Ambient temperature	[°C]	–5 ... +50
Temperature of medium	[°C]	–5 ... +50
CE marking (see declaration of conformity)		To EU EMC Directive ¹⁾ To EU Machinery Directive

1) For information about the area of use, see the EC declaration of conformity at: www.festo.com/catalogue/... → Support/Downloads.

If the devices are subject to usage restrictions in residential, commercial or light-industrial environments, further measures for the reduction of the emitted interference may be necessary.

Datasheet – Control block with safety function for VTSA/VTSA-F

Electrical data for control block			
Electrical connection	Plug to EN 175301-803, type C, without PE conductor		
Nominal operating voltage	[V DC]	24	
Permissible voltage fluctuations	[%]	-15/+10	
Surge resistance	[kV]	2.5	
Pollution degree		3	
Power consumption	[W]	1.8	
Max. magnetic disruption field	[mT]	60	
Switching position sensing	Normal position via sensor		
Duty cycle	[%]	100	
Degree of protection to EN 60529	IP65, NEMA 4 (for all types of signal transmission when mounted)		
Protection against direct and indirect contact	PELV Protection class to EN 60950/IEC 950		
Valve switching time	On	[ms]	22
	Off	[ms]	59
Valve sensor switching time ¹⁾	On	[ms]	60
	Off	[ms]	11

- 1) Valve sensor switching time off: period of time from the coil being energised to the sensor being switched off when using a PNP sensor.
Valve sensor switching time on: period of time from the coil being de-energised to 0-L edge at the sensor when using a PNP sensor.

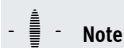

Note

With a duty cycle of 100%, the control block must be de-energised once a week.

Electrical data – Sensor (to EN -60947-5-2)		
Electrical connection	Cable, 3-core 1xM8 plug, 3-pin	
Cable length	[m]	2.5
Switching output	PNP or NPN	
Switching element function	N/C	
Signal status display	Yellow LED	
Operating voltage range	[V DC]	10 ... 30
Residual ripple	[%]	±10
Sensor no-load supply current	[mA]	max. 10
Max. output current	[mA]	200
Voltage drop	[V]	max. 2
Max. switching frequency	[Hz]	5000
Short circuit current rating	Clocked	
Reverse polarity protection for sensor	For all electrical connections	
Measuring principle	Inductive	

Materials	
Sub-base/manifold sub-base	Wrought aluminium alloy
Valve	Die-cast aluminium, PA
Seals	FPM, NBR, HNBR
Screws	Galvanised steel
Sensor housing	High-alloy stainless steel
Sensor cable sheath	PUR
Note on materials	RoHS-compliant

Datasheet – Control block with safety function for VTSA/VTSA-F

Dimensions

Download CAD data → www.festo.com

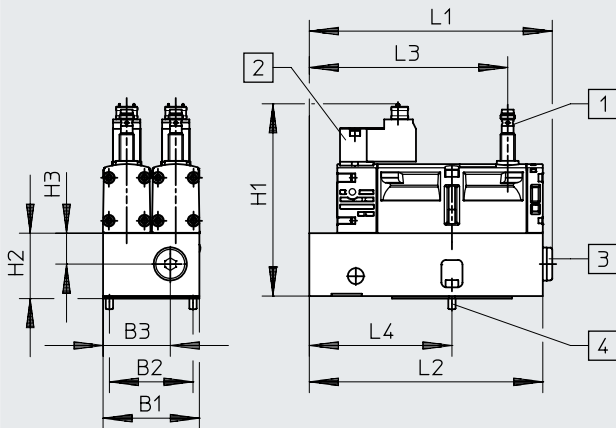

- [1] Proximity switch PNP or NPN, size M8x1, plug connection to EN 61076-2-104
- [2] Electrical connection to EN 175301-803, type C
- [3] Pneumatic connection G1/4 sealed with blanking plug
- [4] 2x screw with internal hexagon (width across flats 2.5), M4x12 (included in the scope of delivery)



Type	B1	B2	B3	H1	H2	H3	L1	L2	L3	L4
VOFA-B26-T52-M-1C1-APP	53	46	37	105.8	34.6	17	133.7	128.5	109.2	78.5
VOFA-B26-T52-M-1C1-ANP										

Ordering data

Valve function	Code	Switching output	Width [mm]	Weight [g]	Part no.	Type
----------------	------	------------------	------------	------------	----------	------

Control block, version for valve terminal VTSA/VTSA-F



	2x 5/2-way valve, single solenoid, mechanical spring return, with switching position sensing via inductive sensor and 3-pin sensor push-in connector M8, mounted on intermediate plate for pneumatic links	SP ²⁾	PNP	53	1112	– ¹⁾	VOFA-B26-T52-M-1C1-APP
		SN ²⁾	NPN	53	1112	– ¹⁾	VOFA-B26-T52-M-1C1-ANP

1) The control block with safety function can only be ordered via the valve terminal configurator and therefore does not have a separate part number. The appropriate manifold sub-base required for the valve terminal VTSA/VTSA-F is automatically allocated to the control block by the configurator
 2) Code letter within the order code for a valve terminal configuration

Note

The sensors integrated in the valves must not be replaced by the customer. Incorrect assembly can result in malfunctions or damage to the valve. Please contact Festo in the event of a malfunction.

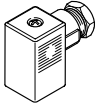

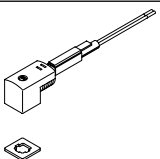
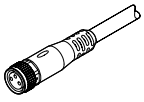
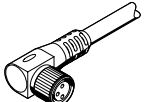
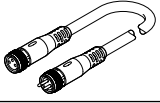
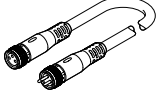
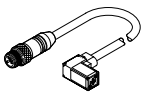
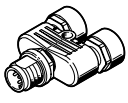

Accessories – Control block with safety function for VTSA/VTSA-F

Ordering data					
	Code	Description	Part no.	Type	
Plug socket for the electrical connection of individual valves, type C					
	–	<ul style="list-style-type: none"> Angled socket, type C, 3-pin Straight plug, PG7 230 V AC 	151687	MSSD-EB	
	–	<ul style="list-style-type: none"> Angled socket, type C, 3-pin Straight plug, M12x1 	539712	MSSD-EB-M12	
Illuminating seal for connection pattern to EN 175301-803, type C			Datasheet → Internet: meb-ld		
	–	For plug socket MSSD, 12 ... 24 V DC	151717	MEB-LD-12-24DC	
Connecting cable for electrical connection of individual valves, type C					
	GG	<ul style="list-style-type: none"> Angled socket, type C, 3-pin, with LED 	2.5 m	151688	KMEB-1-24-2.5-LED
	GH	<ul style="list-style-type: none"> Open end, 3-core 	5 m	151689	KMEB-1-24-5-LED
	GJ	<ul style="list-style-type: none"> 24 V DC, PVC 	10 m	193457	KMEB-1-24-10-LED
Connecting cable for the electrical connection of sensors for switching position sensing					
	GM	<ul style="list-style-type: none"> Straight socket, 1xM8, 3-pin Open end, 3-core 	2.5 m	541333	NEBU-M8G3-K-2.5-LE3
	GN	<ul style="list-style-type: none"> Straight socket, 1xM8, 3-pin Open end, 3-core 	5 m	541334	NEBU-M8G3-K-5-LE3
	–	<ul style="list-style-type: none"> Angled socket, rotatable, 1xM8, 3-pin Open end, 3-core 	2.5 m	8001660	NEBU-M8R3-K-2.5-LE3
	–	<ul style="list-style-type: none"> Angled socket, rotatable, 1xM8, 3-pin Open end, 3-core 	5 m	8001661	NEBU-M8R3-K-5-LE3
	GQ	<ul style="list-style-type: none"> Straight socket, 1xM8, 3-pin Straight plug 1xM8, 4-pin 	2.5 m	554037	NEBU-M8G3-K-2.5-M8G4
	–	Modular system for a choice of connecting cables	–	–	NEBU-... → Internet: nebu
Connecting cable for the electrical connection of PROFIsafe shut-off module CPX-FVDA-P2 to the control block					
	–	<ul style="list-style-type: none"> For the easy connection of one control block valve (power supply via PROFIsafe shut-off module CPX-FVDA-P2) Angled socket, type C, 3-pin, with LED Straight plug 1xM12, 5-pin 24 V DC, PUR 	0.5 m	177677	KMEB-2-24-M12-0.5-LED
Push-in T-connector for dual electrical connection of PROFIsafe shut-off module CPX-FVDA-P2 to the control block					
	–	<ul style="list-style-type: none"> For dual connection of two control block valves (power supply via PROFIsafe shut-off module CPX-FVDA-P2) Straight plug, 1xM12, 5-pin (A-coded) 2x straight socket, 1xM12, 5-pin (A-coded) Operating voltage range 0 ... 30 V DC 	2839867	NEDU-L2R1-V10-M12G5-M12G5	
Pneumatic connection accessories					
A selection of possible fittings, blanking plugs, silencers and other pneumatic accessories can be found in the chapter Accessories → page: 246 or on the website via the individual search terms: Internet → connection technology, silencer, blanking plug					

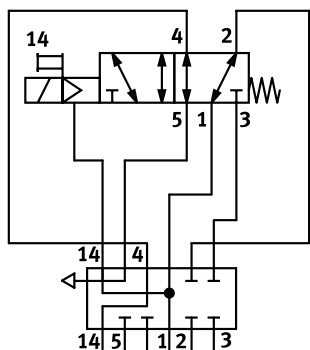
Datasheet – Pilot air switching valve for VTSA/VTSA-F

Function¹⁾



-  - Flow rate
150 l/min (18 mm)
450 l/min (26 mm)
-  - Valve width
18 mm
26 mm
-  - Voltage
24 V DC
-  - Operating pressure
-0.9 ... 10 bar
-0.09 ... 1 MPa

Description

The pilot air switching valve is essentially a combination of a 5/2-way solenoid valve with switching position sensing and the intermediate plate VABF-S4-...-S. It enables the pilot air supply to be verifiably switched on and off (sensing function) from duct 1 to 14 for the entire pressure zone or valve terminal.

This valve is not a safety device in accordance with the Machinery Directive 2006/42/EC. When used in higher categories, the sensor signal from the valve must be evaluated by the control system.

This valve is suitable for use in safety-related parts of control systems to EN ISO 13849-1. This valve is designed for installation in machines and automation systems and must only be used in industrial applications (high-demand mode).

More information and technical data
→ Internet: User documentation

Alternative switching position sensing with pressure switch

As an alternative to the sensing function in the solenoid valve, a pressure switch can be mounted (in place of the blanking plug) on the intermediate plate VABF-S4-...-S. With this pressure switch, the switching on and off (sensing function) of the pilot air supply can be verified.

An ISO solenoid valve without a sensor can therefore be mounted on the intermediate plate to give the same function.

→ Internet: spba

Note

The pilot air switching valve can only be operated on the valve terminal VTSA/VTSA-F in combination with a right end plate for external pilot air type VABE-S6-1RZ-... Port 14 on the right end plate must then be sealed.

Vertical stacking variant for valve terminal VTSA/VTSA-F, width 18 mm, 26 mm

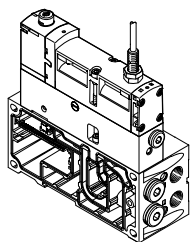

The valves with integrated switching position sensing in plug-in design for valve terminal VTSA/VTSA-F can be used regardless of the type of electrical actuation (individual, multi-pin plug or fieldbus/control block connection).

This module is supplied pre-assembled together with the valve terminal VTSA/VTSA-F. No other assembly steps are required before installation.

Switching position sensing is carried out using an inductive PNP proximity switch with cable and 1xM12 push-in connector to EN 61076-2-104.

Alternatively, combinations with a pressure switch in the intermediate plate and ISO solenoid valves are possible.

Note

All solenoid valves VSVA to ISO 15407-1 can be used.

→ Internet: vsva

1) The circuit symbol represents a valve with a proximity switch with a N/O switching output signal. In accordance with ISO 1219-1, this symbol applies to both N/O and N/C contacts. The switching element function of the sensors used here is designed as an N/C contact.

Datasheet – Pilot air switching valve for VTSA/VTSA-F

Function of pneumatic/electrical links

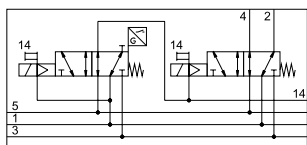

The function for switching off the pilot air is essentially achieved by combining the intermediate plate type VABF-S4-...-S with the 5/2-way single solenoid valve type VSVA-B-M52-MZD-...-1T1L-APX-0.5.

The valve terminal is not supplied with any pilot air via the right end plate type VABE-S6-1 (ident. code XS, external pilot air). Port 14 on the end plate is sealed.

The pilot air for the valve is branched from duct (1) in the intermediate plate and redirected to the pilot air duct (14) of the valve terminal when the valve is in the switching position. Ports (2) and (4) of the manifold sub-base are sealed with blanking plugs. The switching operation of the solenoid valve can be sensed using the proximity switch on the solenoid valve (or pressure switch in the intermediate plate VABF...).

By connecting the control signal and the switching signal of the proximity switch it is possible to check if the piston spools of the solenoid valves have reached or left the normal position (expectations).

The piston spool of the solenoid valve is designed so that pneumatic short circuits between the ports (2) and (4) are prevented (overlap).

Alternatively, combinations with a pressure switch in the intermediate plate and ISO solenoid valves are possible.

Note

A valve from the VTSA/VTSA-F modular system can be provided or configured to the right of the valve with switching position sensing on the intermediate plate of the pilot air switching valve.

Pilot air switching valve with integrated switching position sensing

The pilot air switching valve can be ordered as a combination of a 5/2-way solenoid valve with switching position sensing and the intermediate plate VABF-S4-...-S.

Alternative switching position sensing with pressure switch

As an alternative to the pilot air switching valve with integrated switching position sensing, it is possible to combine an ISO solenoid valve and a pressure switch in the intermediate plate.

To do this, various 5/2-way solenoid valves in combination with a pressure switch SPBA-... are available.

Safety characteristics

Conforms to	EN 13849-1/2
CE marking (see declaration of conformity)	To EU EMC Directive ¹⁾
Shock resistance	Shock test with severity level 2, to EN 60068-2-27
Vibration resistance	Transport application test with severity level 2, to EN 60068-2-6

¹⁾ For information about the area of use, see the EC declaration of conformity at: www.festo.com/catalogue/... → Support/Downloads.
If the devices are subject to usage restrictions in residential, commercial or light-industrial environments, further measures for the reduction of the emitted interference may be necessary.

Safety characteristics

Valve function 5/2-way, single solenoid	Test pulses	
	Max. positive test pulse with logic 0 [µs]	Max. negative test pulse with logic 1 [µs]
VSVA-B-M52-MZ...-A1-1T1L- ...	1200	1100
VSVA-B-M52-MZ...-A2-1T1L- ...	1500	800
VSVA-B-M52-MZ-A1-1C1- ...	1800	800

Datasheet – Pilot air switching valve for VTSA/VTSA-F

General technical data		
	Intermediate plate type VABF-S4-2-S and solenoid valve type VSVA-B-M52-MZD-A2-1T1L-APX-0.5 mounted on valve terminal VTSA/VTSA-F	Intermediate plate type VABF-S4-1-S and solenoid valve type VSVA-B-M52-MZD-A1-1T1L-APX-0.5 mounted on valve terminal VTSA/VTSA-F
Width	18 mm	26 mm
Design	Piston spool valve	
Sealing principle	Soft	
Overlap	Positive overlap	
Actuation type	Electrical	
Type of actuation	Piloted	
Type of mounting: Solenoid valve on intermediate plate	M3	M4
Intermediate plate on manifold sub-base	M3x12 (captive)	M4x12 (captive)
Mounting position	Any	
Pneumatic connections		
Supply	1	Via the manifold sub-base of the valve terminal
Exhausting	3/5	Via the manifold sub-base of the valve terminal
Working ports	2/4	Sealed with blanking plug type B-1/4
Pilot air supply	14	Via the manifold sub-base of the valve terminal
Pressure gauge/pressure switch	G1/8	

Switching times [ms]				
Width		18 mm	26 mm	
Valve type		5/2	5/2	
Identifier		MZD-A2	MZD-A1	MZ-A1
Valve switching time	On	12	20	21
	Off	38	54	41
Valve sensor switching time ¹⁾	On	32	60	60
	Off	9	11	11

1) Valve sensor switching time off: period of time from the coil being energised to the sensor being switched off when using a PNP sensor.
Valve sensor switching time on: period of time from the coil being de-energised to 0-L edge at the sensor when using a PNP sensor.

Protective circuit

Each solenoid coil VSVA is protected with a spark arresting protective circuit as well as against polarity reversal.

24 V DC version

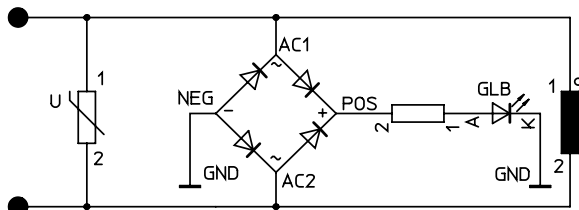

Datasheet – Pilot air switching valve for VTSA/VTSA-F

Peripherals overview

Pilot air switching valve with switching position sensing

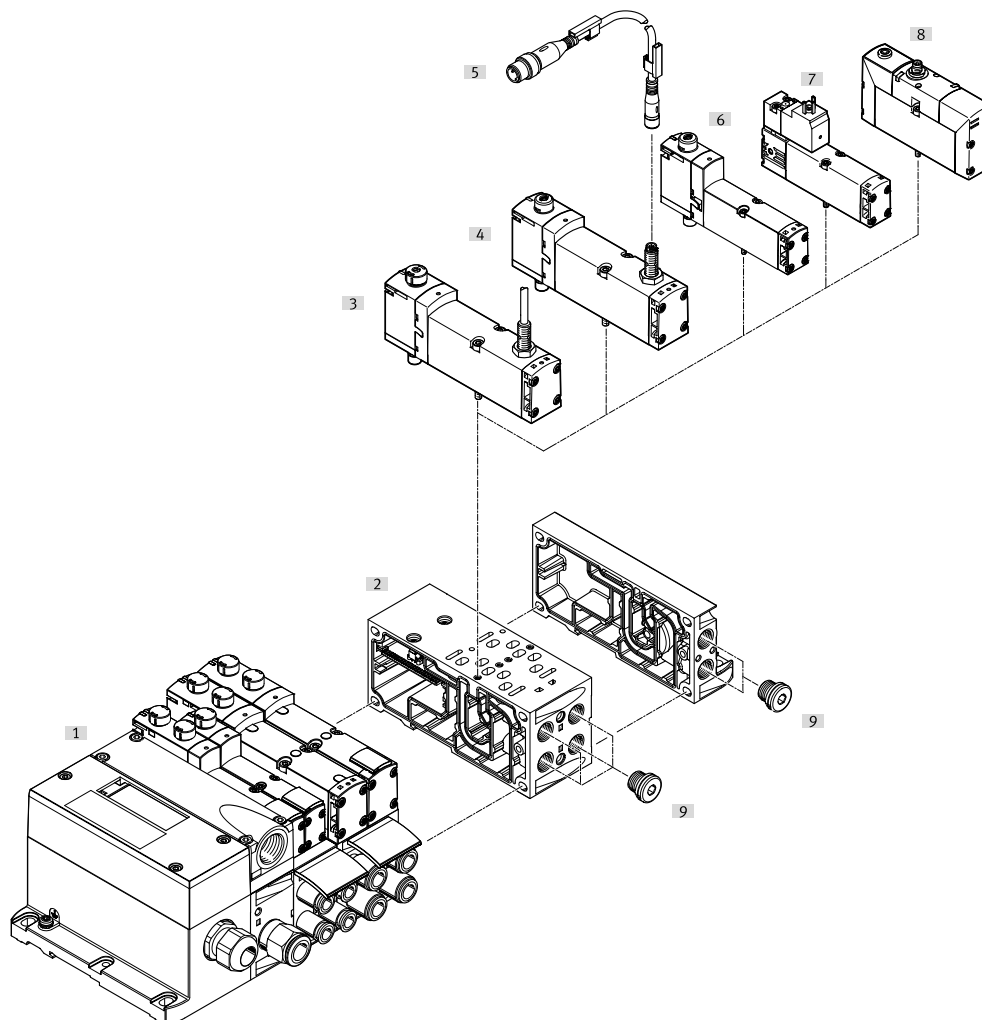

Peripherals overview – Pilot air switching valve		Description	→ Page/Internet
[1]	Valve terminal VTSA/VTSA-F	Valve terminal with multi-pin plug interface	vtsa
[2]	Manifold sub-base VABF-...	Width 18 mm or 26 mm	146
[3]	Intermediate plate VABF-S4-...	For pilot air switching valve	184
[4]	Solenoid valve VSVA-B-M52-...	Width 18 mm or 26 mm, with sensor and integrated cable 0.5 m	184
[5]	Solenoid valve VSVA-B-M52-...	Width 18 mm or 26 mm, with sensor for external connecting cable	184
[6]	Connecting cable NEBU-M8 ...	For connection to sensor	185
[7]	Solenoid valve VSVA-B-M52-...	Width 18 mm or 26 mm ¹⁾	184
[8]	Solenoid valve VSVA-B-M52-...	Width 18 mm or 26 mm, with plug to EN 175301, type C ¹⁾	184
[9]	Solenoid valve VSVA-B-M52-...	Width 18 mm or 26 mm, with round plug ¹⁾	vsva
[10]	Pressure switch SPBA-...	Mechanically actuated	185
[11]	Connecting cable NEBU-M12G5-...	For connection to pressure switch	185
[12]	Pressure switch SPBA-...	Electrically actuated	185
[13]	Blanking plug	–	247

1) The switching position is sensed by pressure switches when the solenoid valves used have no integrated sensor.
The pressure switch is screwed into the intermediate plate in place of the blanking plug.

Datasheet – Pilot air switching valve for VTSA/VTSA-F

Electrical data for pilot air switching valve		
Nominal operating voltage	[V DC]	24
Permissible voltage fluctuations	[%]	±10
Surge resistance	[kV]	2.5
Pollution degree		3
Power consumption	[W]	1.6 (M52-MZD), 1.8 (M52-MZ)
Max. magnetic disruption field	[mT]	60
Switching position sensing		Normal position via sensor
Duty cycle	[%]	100
Degree of protection		IP65, NEMA 4 (for all types of signal transmission when mounted)

Electrical data for sensor					
Sensor identifier	APP	ANP	APC	ANC	APX
Switching output	PNP	NPN	PNP	NPN	PNP
Sensor connection	Plug, 1xM8, 3-pin		With fixed cable and open end		With fixed cable and plug M12x1, 4-pin
Cable length	[m]	0.5 (with 1xM8 socket, 1xM12 plug)	2.5		0.5
Switching element function	N/C				
Signal status display	Yellow LED (on sensor)				
Operating voltage range	[V DC]	10 ... 30			
Residual ripple	[%]	±10			
Rated operating voltage	[V DC]	24			
Max. no-load supply current	[mA]	10			
Max. output current	[mA]	200			
Max. voltage drop	[V]	2			
Max. switching frequency	[Hz]	5000			
Short circuit current rating	Clamped				
Reverse polarity protection	For all electrical connections				
Measuring principle	Inductive				
Switching position sensing	Valve normal position via sensor				

Datasheet – Pilot air switching valve for VTSA/VTSA-F

Operating and environmental conditions				
Valve	VSVA-B-M52-...-1T1L-...	VSVA-B-M52-...-1C1-...	Without sensor	
Operating medium	Compressed air to ISO 8573-1:2010 [7:4:4]			
Notes on operating/ Pilot medium	Lubricated operation possible (in which case lubricated operation will always be required)			
Operating pressure	[bar]	-0.9 ... 10	-0.9 ... 16	-0.9 ... 10
	[MPa]	-0.09 ... 1	-0.09 ... 1	-0.09 ... 1
Noise level LpA	[dB(A)]	85	85	-
Ambient temperature	[°C]	-5 ... +50	-5 ... +50	-5 ... +50
Temperature of medium	[°C]	-5 ... +50	-5 ... +50	-
Note on materials	RoHS-compliant	RoHS-compliant	RoHS-compliant	
KC marking	KC EMC	KC EMC	-	
UKCA marking	To UK instructions for EMC	To UK instructions for EMC	-	
Certification	C-Tick	C-Tick	-	
	c UL us Recognized (OL)	-	c UL us Recognized (OL)	

Materials	
Sub-base/manifold sub-base	Die-cast aluminium
Valve	Die-cast aluminium, PA
Seals	FPM, NBR
Screws	Galvanised steel
Sensor housing	High-alloy stainless steel
Sensor cable sheath	TPE-U(PUR)

Product weight [g]		
Width	18 mm	26 mm
5/2-way solenoid valve type...		
VSVA-B-M52-M...-A1-1T1L-APC	-	307
VSVA-B-M52-M...-A1-1T1L-APP	-	264
VSVA-B-M52-M...-A1-1C1-APC	-	332
VSVA-B-M52-M...-A1-1C1-APP	-	289
VSVA-B-M52-M...-A1-1T1L-ANC	-	307
VSVA-B-M52-M...-A1-1T1L-ANP	-	264
VSVA-B-M52-M...-A1-1C1-ANC	-	332
VSVA-B-M52-M...-A1-1C1-ANP	-	289
VSVA-B-M52-M...-A1-1T1L-APX-0.5	-	281
VSVA-B-M52-M...-A2-1T1L-APX-0.5	157	-
VSVA-B-M52-M...-A2-1T1L-APP	140	-
VSVA-B-M52-M...-A2-1T1L-ANP	140	-
VSVA-B-M52-M...-A1-1T1L	-	293
VSVA-B-M52-M...-A2-1T1L	163	-

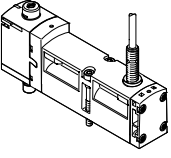
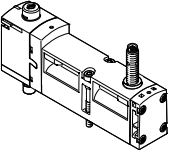
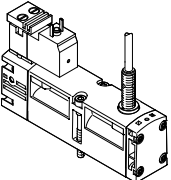
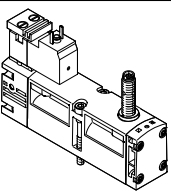
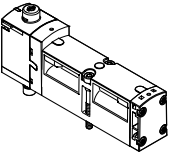

Ordering data – Pilot air switching valve for VTSA/VTSA-F

Ordering data						
	Code	Valve function		Part no.	Type	
5/2-way solenoid valve, 24 V DC, plug-in design with proximity switch						
	SS	5/2-way valve, single solenoid, mechanical spring return, with 0.5 m connecting cable and 4-pin sensor push-in connector M12x1	PNP	18 mm	573201	VSVA-B-M52-MZD-A2-1T1L-APX-0.5
				26 mm	570850	VSVA-B-M52-MZD-A1-1T1L-APX-0.5
	-	5/2-way valve, single solenoid, mechanical spring return, with 2.5 m connecting cable	PNP	26 mm	560723	VSVA-B-M52-MZD-A1-1T1L-APC
			NPN	26 mm	560742	VSVA-B-M52-MZD-A1-1T1L-ANC
	SO	5/2-way valve, single solenoid, mechanical spring return, with 3-pin sensor push-in connector M8x1	PNP	18 mm	573202	VSVA-B-M52-MZD-A2-1T1L-APP
				26 mm	560724	VSVA-B-M52-MZD-A1-1T1L-APP
	SQ		NPN	18 mm	573203	VSVA-B-M52-MZD-A2-1T1L-ANP
				26 mm	560743	VSVA-B-M52-MZD-A1-1T1L-ANP
	-	5/2-way valve, single solenoid, mechanical spring return, with plug to EN 175301, type C, with 2.5 m connecting cable	PNP	26 mm	560725	VSVA-B-M52-MZ-A1-1C1-APC
			NPN	26 mm	560745	VSVA-B-M52-MZ-A1-1C1-ANP
	-	5/2-way valve, single solenoid, mechanical spring return, with plug to EN 175301, type C, with 3-pin sensor push-in connector M8x1	PNP	26 mm	560726	VSVA-B-M52-MZ-A1-1C1-APP
			NPN	26 mm	560744	VSVA-B-M52-MZ-A1-1C1-ANC
5/2-way solenoid valve, 24 V DC, plug-in design						
	-	5/2-way valve, single solenoid, mechanical spring return		26 mm	539159	VSVA-B-M52-MZD-A1-1T1L
				18 mm	539185	VSVA-B-M52-MZD-A2-1T1L

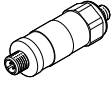

 **Note**
 Further solenoid valves with switching position sensing can be ordered as distinct types. These are preconfigured with the required MO cover caps.
 → Solenoid valve with switching position sensing, page 167

 **Note**
 The sensors integrated in the valves must not be replaced by the customer. Incorrect assembly can result in malfunctions or damage to the valve. Please contact Festo in the event of a malfunction.

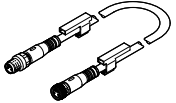
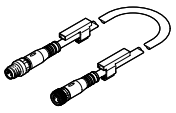
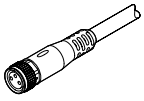
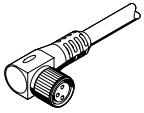
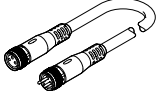
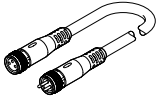
Ordering data – Pilot air switching valve for VTSA/VTSA-F

Ordering data					
	Code	Description	Part no.	Type	
Pressure switch for intermediate plate for pilot air switching valve					
	WL	Mechanical pressure switch for switchable pilot air supply (only in combination with intermediate plate ZO), with plug M12x1, 4-pin	8000033	SPBA-P2R-G18-W-M12-0.25X	
	WH	Electrical pressure switch for switchable pilot air supply, switching output 2xPNP (only in combination with intermediate plate ZO), with 1xM12 plug, 4-pin	8000210	SPBA-P2R-G18-2P-M12-0.25X	
Connecting cable for connection of pressure switches					
	GE	<ul style="list-style-type: none"> Straight socket, 1xM12, 5-pin Straight plug 1xM12, 4-pin 	0.5 m	8000208	NEBU-M12G5-K-0.5-M12G4
Connecting cable for the electrical connection of sensors for switching position sensing					
	–	<ul style="list-style-type: none"> Straight socket, 1xM8, 3-pin Straight plug 1xM12, 3-pin 	0.5 m	8000209	NEBU-M8G3-K-0.5-M12G3
	GM	<ul style="list-style-type: none"> Straight socket, 1xM8, 3-pin Open end, 3-core 	2.5 m	541333	NEBU-M8G3-K-2.5-LE3
	GN	<ul style="list-style-type: none"> Straight socket, 1xM8, 3-pin Open end, 3-core 	5 m	541334	NEBU-M8G3-K-5-LE3
	GO	<ul style="list-style-type: none"> Angled socket, 1xM8, 3-pin Open end, 3-core 	2.5 m	541338	NEBU-M8W3-K-2.5-LE3
	GP	<ul style="list-style-type: none"> Angled socket, 1xM8, 3-pin Open end, 3-core 	5 m	541341	NEBU-M8W3-K-5-LE3
	–	<ul style="list-style-type: none"> Angled socket, rotatable, 1xM8, 3-pin Open end, 3-core 	2.5 m	8001660	NEBU-M8R3-K-2.5-LE3
	–	<ul style="list-style-type: none"> Angled socket, rotatable, 1xM8, 3-pin Open end, 3-core 	5 m	8001661	NEBU-M8R3-K-5-LE3
	GQ	<ul style="list-style-type: none"> Straight socket, 1xM8, 3-pin Straight plug 1xM8, 4-pin 	2.5 m	554037	NEBU-M8G3-K-2.5-M8G4
	–	Modular system for a choice of connecting cables	–	–	NEBU-... → Internet: nebu



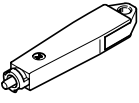

Ordering data – Pilot air switching valve for VTSA/VTSA-F

Ordering data				
	Code	Description	Part no.	Type
Covering				
	N	Cover cap for manual override, non-detenting	10 pieces	541010 VAMC-S6-CH
	V	Cover cap for manual override, concealed	10 pieces	541011 VAMC-S6-CS
	A	Cover cap, heavy duty, for manual override, non-detenting heavy duty, detenting via accessory (key) (The cover cap is provided for one-off mounting only)	10 pieces	4105147 VAMC-B-S6-CTR
Accessories for manual override, heavy duty				
	-	Coded key (accessory) for actuating the cover cap, heavy duty, for detenting position (VAMC-B-S6-CTR)	1 piece	1662543 AHB-MEB-B
Pneumatic connection accessories				
A selection of possible fittings, blanking plugs, silencers and other pneumatic accessories can be found in the chapter Accessories → page: 246 or on the website via the individual search terms: Internet → connection technology, silencer, blanking plug				

 **Note**

There is a wide range of preconfigured solenoid valves with cover cap for manual override and correct valve type code available to order in the sections on solenoid valves.

Datasheet – Pilot air switching valve for VTSA/VTSA-F-CB

-  - Flow rate 125 l/min
-  - Pilot air switching valve width 18 mm
-  - Voltage 24 V DC
-  - Operating pressure 0.3 ... 1 MPa

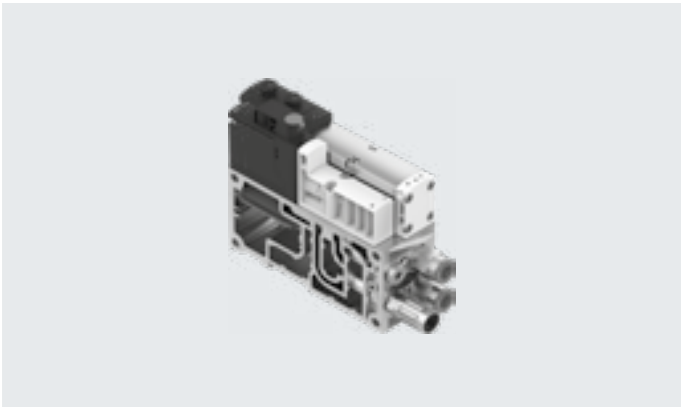

Description

Duct 14 of the valve terminal is supplied with pilot air via the pilot air switching valve. This can be used to realise the safety function "Protection against unexpected start-up". The pilot air switching valve is always supplied with internal pilot air from the valve terminal. The valve terminal can be operated with internal pilot air (from duct 1 of the valve terminal) or with external pilot air (external compressed air supply via duct 2).

The pilot air switching valve is actuated via an electromagnetic pilot control. It can be switched on and off manually using the manual override. The manual override can be shut off manually or using the electrical pilot control. The pilot air switching valve enables the pilot air supply to be verifiably switched on and off (sensor function) from duct 1 to 14 for the entire pressure zone or valve terminal.

This valve is not a safety device in accordance with the Machinery Directive 2006/42/EC. When used in higher categories, the sensor signal from the valve must be evaluated by the control system. This valve is suitable for use in safety-related parts of control systems to EN ISO 13849-1.

This valve is designed for installation in machines and automation systems and must only be used in industrial applications (high-demand mode). More information and technical data

 **Note**

The pilot air switching valve can only be operated on the valve terminal VTSA/VTSA-F in combination with a right-hand end plate for external pilot air type VABE-S6-1RZ-.... Port 14 on the right-hand end plate must then be sealed. This information applies only for a single pressure zone.

Safety data

Max. positive test pulse with logic 0	[µs]	2000
Max. negative test pulse with logic 1	[µs]	1200
Shock resistance		Shock test with severity level 2, to EN 60068-2-27
Vibration resistant		Transport application test with severity level 2, to EN 60068-2-6

Datasheet – Pilot air switching valve for VTSA/VTSA-F-CB

General technical data		
Design	Poppet valve	
Valve function	3/2-way closed, single solenoid	
Standard nominal flow rate	[l/min]	125
Standard nominal flow rate for exhaust	[l/min]	125
Reset method	Mechanical spring and pneumatic spring	
Sealing principle	Soft	
Actuation type	Electrical	
Overlap	Negative overlap	
Type of control	Piloted	
Mounting position	Any	
Flow direction	Not reversible	
Manual override	None (no code, part nos.: 8066575, 8066574, 8066571, 8066570)	
	Detenting, self-resetting via electrical control signal (with code YE, part nos.: 8066573, 8066572, 8066569, 8066568)	
	Non-detenting (part nos.: 8171467, 8171468, 8171469, 8171470)	
Pilot air supply	For pilot air switching valve: internal via valve terminal	
	For the valve terminal: internal via valve terminal (duct 1) – (part nos.: 8066569, 8066568, 8066571, 8066570)	
	For the valve terminal: external via compressed air supply (duct 2) – (part nos.: 8066573, 8066572, 8066575, 8066574)	
Type of mounting	Via through-hole, on manifold sub-base	
MTTF subcomponent	443 years, pressure switch	
Width, manifold sub-base	[mm]	38 (for additional valve 18 mm)
	[mm]	46 (for additional valve 26 mm)
Pneumatic connections, pilot air switching valve		
Supply	1	Via the manifold sub-base of the valve terminal
Exhausting	3/5	Via the manifold sub-base of the valve terminal
Supply port (external)	2	G1/8
Exhaust air/exhaust	4	G1/8
Pilot air supply	14	Via the manifold sub-base of the valve terminal
Pneumatic connections, additional valve position		
Supply	1	Via the manifold sub-base of the valve terminal
Exhausting	3/5	Via the manifold sub-base of the valve terminal
Working ports (for valve 18 mm)	2/4	G1/8
Working ports (for valve 26 mm)	2/4	G1/4
Pilot air supply	14	Via the manifold sub-base of the valve terminal
Operating and environmental conditions		
Operating medium	Compressed air to ISO 8573-1:2010 [7:4:4]	
Pilot medium	Compressed air to ISO 8573-1:2010 [7:4:4]	
Notes on operating/pilot medium	Lubricated operation not possible	
Operating pressure ²⁾	[bar]	3 ... 10
	[MPa]	0.3 ... 1
Pilot pressure	[bar]	3 ... 10
	[MPa]	0.3 ... 1
Ambient temperature ²⁾	[°C]	-5 ... +50
Temperature of medium ²⁾	[°C]	-5 ... +50
Corrosion resistance class CRC ¹⁾	0	

1) More information: www.festo.com/x/topic/crc

2) With an ambient temperature and a temperature of the medium from -5°C to +5°C and +40°C to +50°C, the maximum permissible operating pressure is 8 bar.

Datasheet – Pilot air switching valve for VTSA/VTSA-F-CB

Electrical data – Pilot air switching valve		
Nominal operating voltage	[V DC]	24
Permissible voltage fluctuations	[%]	±10
Electrical connection		Plug-in
Power consumption	[W]	1.6
Switching element function		N/C
Switching position sensing		Via pressure switch, exhausted status
Signal status display		Yellow LED, valve control
		Green LED, pressure switch, exhausted status
Duty cycle	[%]	100
Degree of protection		IP65

Materials	
Housing	Reinforced PA
Seals	NBR, HNBR
Screws	Galvanised steel
Note on materials	RoHS-compliant

Connection and display components
 Pilot air switching valve VSVA-BT-M32CS... with manifold sub-base

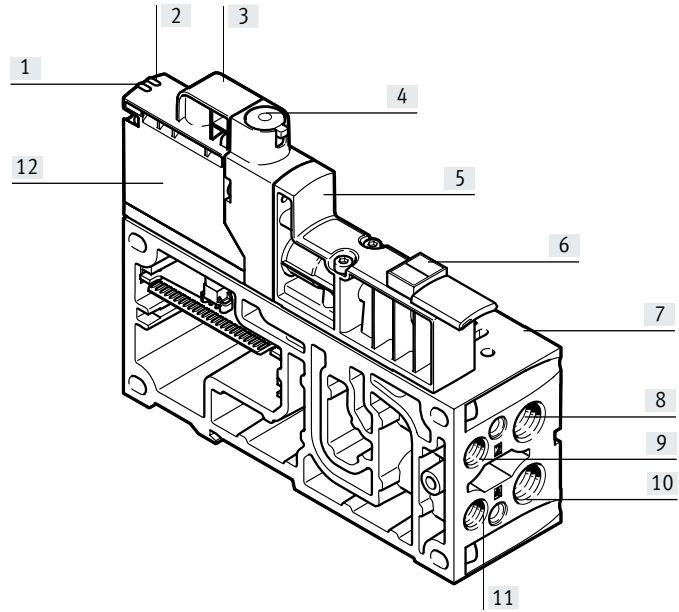

- [1] Status LED for solenoid coil
- [2] Status LED for pressure switch
- [3] M12 connection (optional)
- [4] Manual override (MO) (optional)
- [5] Solenoid valve housing
- [6] Inscription label holder with additional fields for marking (ASCFT-S6-Z)
- [7] Additional valve position
- [8] Working port (2) of the additional valve position
- [9] External supply port
- [10] Working port (4) of the additional valve position
- [11] Exhaust port
- [12] Pilot control

Note
 Detailed information on the manual override can be found in the user documentation.

Datasheet – Pilot air switching valve for VTSA-F-CB

Valve function		
Terminal code	Circuit symbol	Description
CT		<ul style="list-style-type: none"> Pilot air supply via duct 2 (external pilot air) of manifold sub-base Without manual override (MO)
CT		<ul style="list-style-type: none"> Pilot air supply via duct 2 (external pilot air) of manifold sub-base With manual override (MO)
AT		<ul style="list-style-type: none"> Pilot air supply via duct 2 (external pilot air) of manifold sub-base Without manual override (MO)
AT		<ul style="list-style-type: none"> Pilot air supply via duct 2 (external pilot air) of manifold sub-base With manual override (MO)
CS		<ul style="list-style-type: none"> Pilot air supply via duct 1 (internal pilot air) for the valve terminal's pressure zone (end plate/additional supply plate) Without manual override (MO)
CS		<ul style="list-style-type: none"> Pilot air supply via duct 1 (internal pilot air) for the valve terminal's pressure zone (end plate/additional supply plate) With manual override (MO)
AS		<ul style="list-style-type: none"> Pilot air supply via duct 1 (internal pilot air) for the valve terminal's pressure zone (end plate/additional supply plate) Without manual override (MO)
AS		<ul style="list-style-type: none"> Pilot air supply via duct 1 (internal pilot air) for the valve terminal's pressure zone (end plate/additional supply plate) With manual override (MO)

Datasheet – Pilot air switching valve for VTSA/VTSA-F-CB

Dimensions

Download CAD data → www.festo.com

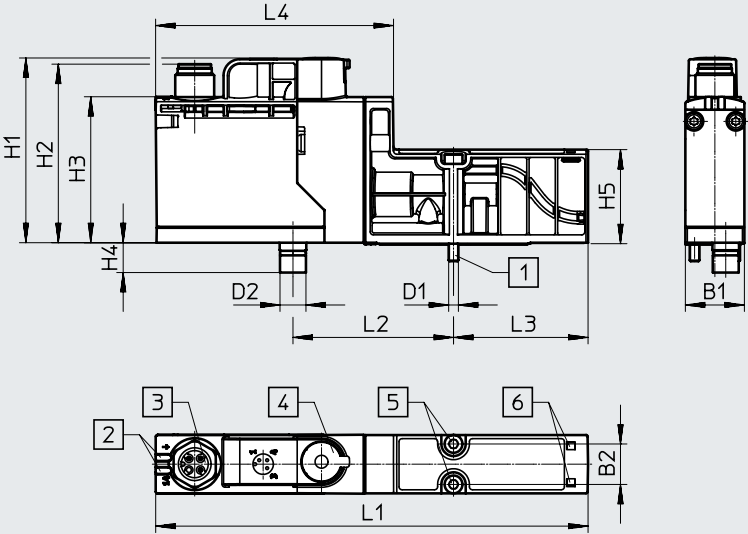

- [1] Socket head screw
M3x30-8.8
- [2] Light emitting diodes (LED)
- [3] M12 connection (optional)
- [4] Manual override (MO), self-re-setting
- [5] Internal hexagon
- [6] Space for inscription label

Type	B1	B2	D1	D2 ∅	H1	H2	H3	H4	H5	L1	L2	L3	L4
VSVA-BT-M32CS...	18	12.5	M3	8	57	55.1	45	9.2	29	134	49.5	41.5	74

Datasheet – Pilot air switching valve for VTSA-F-CB

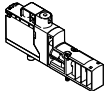
Ordering data											
Code VTSA-F-CB	Code VTSA/ VTSA-F	Description	Operating pressure ¹⁾		Standard nominal flow rate ²⁾		Wt. ³⁾ [g]	Part no.	Type		
			[MPa]	[bar]	[l/min]	Exhausting [l/min]					
3/2-way solenoid valve, 24 V DC, plug-in design											
3/2-way solenoid valve NC, external pilot air supply for the valve terminal											
	CT	–	Control plug-in, pressure sensor plug-in, manual override (MO) self-resetting	18 mm	0.3 ... 1	3 ... 10	150	150	110	8066573	VSVA-BT-M32CS2-MYE-A2-1T5L-PA
	CT	AT	Control plug-in, external pressure sensor M12, manual override (MO) self-resetting	18 mm	0.3 ... 1	3 ... 10	150	150	110	8066572	VSVA-BT-M32CS2-MYE-A2-1T1L-PZ
	CT	–	Control plug-in, pressure sensor plug-in, manual override (MO) concealed	18 mm	0.3 ... 1	3 ... 10	150	150	110	8066575	VSVA-BT-M32CS2-MS-A2-1T5L-PA
	CT	AT	Control plug-in, external pressure sensor M12, manual override (MO) concealed	18 mm	0.3 ... 1	3 ... 10	150	150	110	8066574	VSVA-BT-M32CS2-MS-A2-1T1L-PZ
	CT	–	Control plug-in, pressure sensor plug-in, manual override (MO) non-detenting	18 mm	0.3 ... 1	3 ... 10	125	125	110	8171467	VSVA-BT-M32CS2-MH-A2-1T5L-PA
	CT	AT	Control plug-in, pressure sensor plug-in, manual override (MO) non-detenting	18 mm	0.3 ... 1	3 ... 10	125	125	110	8171469	VSVA-BT-M32CS2-MH-A2-1T1L-PZ
3/2-way solenoid valve NC, internal pilot air supply for the valve terminal											
	CS	–	Control plug-in, pressure sensor plug-in, manual override (MO) self-resetting	18 mm	0.3 ... 1	3 ... 10	150	150	110	8066569	VSVA-BT-M32CS1-MYE-A2-1T5L-PA
	CS	AS	Control plug-in, external pressure sensor M12, manual override (MO) self-resetting	18 mm	0.3 ... 1	3 ... 10	150	150	110	8066568	VSVA-BT-M32CS1-MYE-A2-1T1L-PZ
	CS	–	Control plug-in, pressure sensor plug-in, manual override (MO) concealed	18 mm	0.3 ... 1	3 ... 10	150	150	110	8066571	VSVA-BT-M32CS1-MS-A2-1T5L-PA
	CS	AS	Control plug-in, external pressure sensor M12, manual override (MO) concealed	18 mm	0.3 ... 1	3 ... 10	150	150	110	8066570	VSVA-BT-M32CS1-MS-A2-1T1L-PZ
	CS	–	Control plug-in, external pressure sensor M12, manual override (MO) non-detenting	18 mm	0.3 ... 1	3 ... 10	125	125	110	8171468	VSVA-BT-M32CS1-MH-A2-1T5L-PA
	CS	AS	Control plug-in, external pressure sensor M12, manual override (MO) non-detenting	18 mm	0.3 ... 1	3 ... 10	125	125	110	8171470	VSVA-BT-M32CS1-MH-A2-1T1L-PZ

1) With ambient temperature and temperature of medium of from -5°C to +5°C and 40°C to 50°C, the maximum permissible operating pressure is 0.8 MPA or 8 bar.

2) +/- 15% to FN 942032

3) Weight of pilot air switching valve without manifold sub-base

Datasheet – Pilot air switching valve for VTSA/VTSA-F-CB

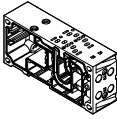
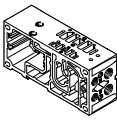
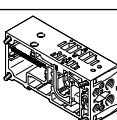
Ordering data						
	Code VTSA-F-CB	Code VTSA/VTSA-F	Description	Weight [g]	Part no.	Type
Manifold sub-base for pilot air switching valve						
	YB		For 2 valve positions (4 addresses) 1x valve position, 1x double solenoid valve, high flow	18 mm	434	8068913 VABF-S4-2HS-G18-CB-2T5
	YC		Hybrid manifold sub-base, width 18 and 26 mm For 2 valve positions (4 addresses) 1x valve position with CBUS communication, 1x double solenoid valve, high flow (with CBUS loop-through)	18 mm/26 mm	512	8068912 VABV-S4-12HS-G-CB-2T5
	–	XA	Hybrid manifold sub-base, width 18 and 26 mm For 2 valve positions (4 addresses)	18 mm/26 mm	512	8190411 VABV-S4-12HS-G-2T2



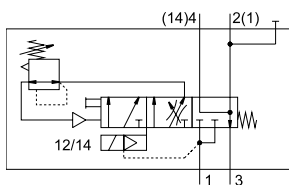

Datasheet – Soft-start valve for VTSA/VTSA-F

Function
without sensor

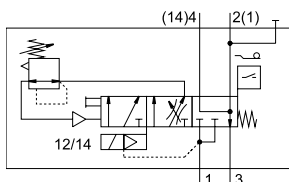

With sensor



-  - Flow rate
Pressurisation:
3000 l/min
Exhausting: 3300 l/min
-  - Module width
43 mm
-  - Temperature range
-5 ... +50°C
-  - Operating pressure
2 ... 12 bar
0.2 ... 1.2 MPa

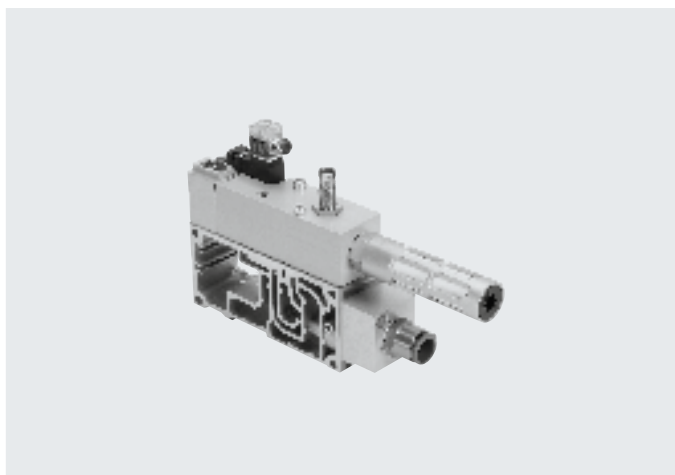

Description

Function

The purpose of the soft-start valve is to slowly and safely build up the supply pressure in duct 1 of the valve terminal or to quickly exhaust it via duct 1.

Switch-on takes place in two stages:

- First the working pressure for duct 1 gradually increases (the speed can be adjusted using a flow control screw).

- Once the working pressure in duct 1 reaches a previously set value, the soft-start valve switches to full operating pressure at duct 1 of the valve terminal.

The switching point for full operating pressure is set to 4 bar at the factory, but can be changed using an adjusting screw.

The full operating pressure is applied at duct 14 (pilot air) at all times. This pressure causes the valves on the valve terminal to immediately move to the required switching position, so an unspecified position is not possible.

Duct 1 of the valve terminal is exhausted via the soft-start valve's exhaust port only in the normal position, when the valve is not switched. The exhaust air can optionally be ducted with a QS fitting or using a silencer.

A detenting manual override with self-reset via an electrical control signal is available for maintenance and service purposes.

Note

When using "Protection against unexpected start-up":

Protection against unexpected activation of the manual override (MO) must be guaranteed in all operating modes.

Diagnostics

The piston position of the soft-start valve can be monitored by a sensor with integrated LED display. This sensor registers whether the valve has switched and thus whether the valve terminal is being supplied with compressed air.

Pressure sensing via a pressure gauge (optional) is also possible.

The soft-start valve can also be ordered with a sensor. A sensor cannot be retrofitted at a later date due to the calibration that is required.

Connecting cables with integrated LED display are provided for displaying the signal status.

Pilot air supply

The valve terminal can either be supplied with internal pilot air via the soft-start valve or with internal or external pilot air via the various end plate variants.

The pilot air supply for the valve terminal (internal/external) is determined by the seal between the manifold sub-base and the soft-start valve.

The scope of delivery of the soft-start valve includes both the seal for internal pilot air supply (with drilled hole) and the seal for external pilot air supply (no drilled hole).

The soft-start valve itself is always supplied with internal pilot air.

Datasheet – Soft-start valve for VTSA/VTSA-F

Description

Creating pressure zones with a soft-start valve

The soft-start valve can be used for the pneumatic compressed air supply of the valve terminal or of a pressure zone. The soft-start valve can only be used as the sole compressed air supply component on valve terminals with one pressure zone or within a pressure zone.

If a soft-start valve in combination with a right end plate (code XP3) is chosen for a pressure zone, this pressure zone must have a supply plate with a blanking plug in duct 1 (code W).

When using a soft-start valve, a supply plate (with blanking plug in duct 1) is generally also required for this pressure zone to discharge the exhaust air (duct 3/5).

A supply plate is not required if the exhaust air (duct 3/5) in a pressure zone with soft-start valve can be discharged via the right end plate.

Constraints

Compressed air supply

There must be no other elements supplying compressed air in the pressure zone in which the soft-start valve is being used.

Exhaust air

Exhaust air cannot be expelled via the soft-start valve. If it is being used in a pressure zone with duct 3/5 separate, an exhaust plate is required.

Pilot air supply

If the soft-start valve is used for internal pilot air supply (duct 14), there must be no other pilot air supply within the valve terminal.

Reverse operation

The soft-start valve is not approved for reverse operation.

Note

Setting options as well as drawings with descriptions of the components for the soft-start valve can be found in the user documentation.

The adjusting screws are freely accessible once they are fitted.

Safety characteristics

Conforms to	ISO 5599-2
Note on forced checking procedure	Switching frequency min. 1/month
Max. positive test pulse with logic 0	[μs] 2500 ¹⁾
Max. negative test pulse with logic 1	[μs] 1400 ¹⁾
Shock resistance	Shock test with severity level 2, to EN 60068-2-27
Vibration resistance	Transport application test with severity level 2, to EN 60068-2-6

1) Values apply only to types with direct voltage 24 V DC

General technical data

Design	Piston spool
Actuation type	Electrical
Sealing principle	Soft
Type of mounting	On sub-base, ISO size 1 to ISO 5599-2
Mounting position	Any
Valve function	Soft-start function
Manual override	Detenting, self-resetting via electrical control signal, normal position on top, → page 201
Reset method	Mechanical spring
Type of actuation	Piloted
Pilot air supply	Internal, external
Flow direction	Not reversible
Switching position sensing	Switching position with sensor

Standard nominal flow rate [l/min]

Pressurisation	3000
Exhausting	3300

Datasheet – Soft-start valve for VTSA/VTSA-F

Operating and environmental conditions		
Operating medium		Compressed air to ISO 8573-1:2010 [7:4:4]
Notes on operating/ pilot medium		Lubricated operation possible (in which case lubricated operation will always be required)
Operating pressure	[bar]	2 ... 12
	[MPa]	0.2 ... 1.2
Switchover pressure presetting	[bar]	4
	[MPa]	0.4
Ambient temperature	[°C]	-5 ... +50
Note on materials		RoHS-compliant

Valve switching times [ms]		
Valve switching time	On	17
	Off	50

Electrical data for soft-start valve		
Electrical connection		Plug, type C to EN 175301-803, square design
Nominal operating voltage	[V]	24 DC
Operating voltage range	[V]	24 DC ±10%
Characteristic coil data		24 V DC: 2.5 W
Degree of protection to EN 60529		IP65, NEMA 4 (for all types of signal transmission when mounted)

Electrical data for sensor		
Type	SIEN-M12B-PS-S-L	SIEN-M12B-NS-S-L
Electrical connection	1xM12 plug to EN 60947-5-2, 4-pin	
Switching output	PNP	NPN
Switching element function	N/O	
Signal status display	Yellow LED	
Operating voltage range	[V DC]	10 ... 30
Residual ripple	[%]	±10
Rated operating voltage	[V DC]	24
Max. no-load supply current for sensor	[mA]	10
Max. output current	[mA]	200
Max. voltage drop	[V]	2
Max. switching frequency	[Hz]	3000
Short circuit current rating	Clamped	
Reverse polarity protection for sensor	For all electrical connections	
Measuring principle	Inductive	
Switching position sensing	Switching position with sensor	

Materials		
	Soft-start valve	Manifold sub-base
Housing	Wrought aluminium alloy	Die-cast aluminium
Seals	NBR, HNBR	-
Screws	Galvanised steel	-

Datasheet – Soft-start valve for VTSA/VTSA-F

Example 1: Pressure zone with soft-start valve and pilot air supply

Internal, external pilot air supply

Requirements

- Compressed air supply via soft-start valve
- Right end plate¹⁾: Blanking plug in duct 1

For internal pilot air supply:

- Seal (soft-start valve - manifold sub-base) with pilot air supply bore "open" and
- Right end plate: Blanking plug in duct 14

For external pilot air supply:

- Seal (soft-start valve - manifold sub-base) with pilot air supply bore "closed" and
- Pilot air supply via duct 14 in the right end plate

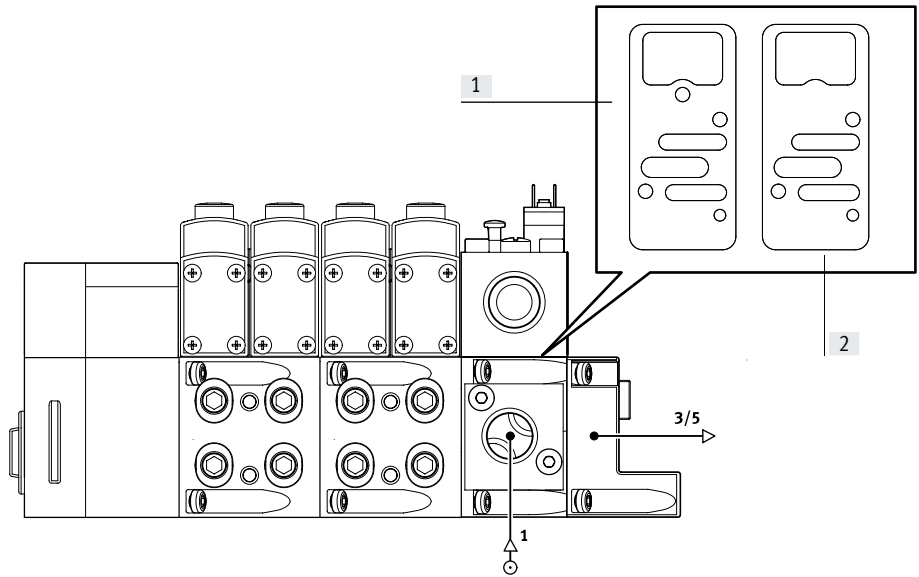

- [1] Seal for internal pilot air supply
- [2] Seal for external pilot air supply

1) With this configuration, a right end plate with pilot air selector cannot be used, as it doesn't allow the exhaust air to be discharged

Example 2: Pressure zone with soft-start valve, supply plate and pilot air supply

Internal, external pilot air supply

Requirements

- Compressed air supply via soft-start valve
- Supply plate: Blanking plug in duct 1
- Right end plate: blanking plug in duct 1, 3, 5 or
- Right end plate with pilot air selector

For internal pilot air supply:

- Seal (soft-start valve - manifold sub-base) with pilot air supply bore "open" and
- Right end plate: blanking plug in duct 14 or
- End plate with coding (position 2, internal pilot air supply)

For external pilot air supply:

- Seal (soft-start valve - manifold sub-base) with pilot air supply bore "closed" and
- Pilot air supply via duct 14 in the right end plate or
- End plate with coding (position 1, external pilot air supply)

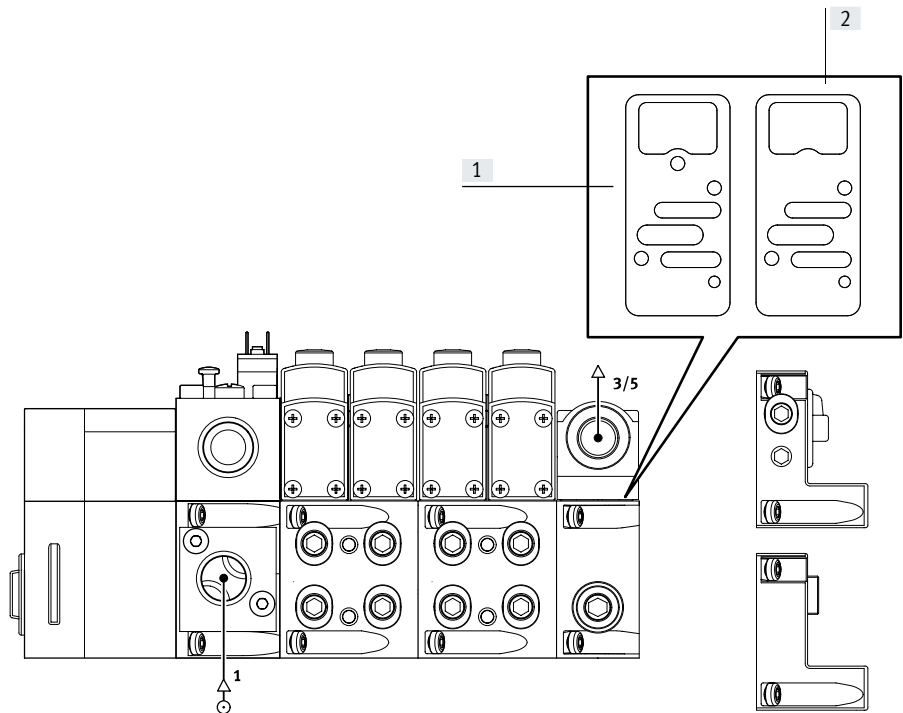

- [1] Seal for internal pilot air supply
- [2] Seal for external pilot air supply

Datasheet – Soft-start valve for VTSA/VTSA-F

Practical example 1: Valve terminal VTSA with CPX terminal (metal design) and soft-start valve

With internal pilot air (PP and XP2):

Selection no. in the digital customer information system: 539217

With external pilot air (PM and XP1):

Selection no. in the digital customer information system: 539217

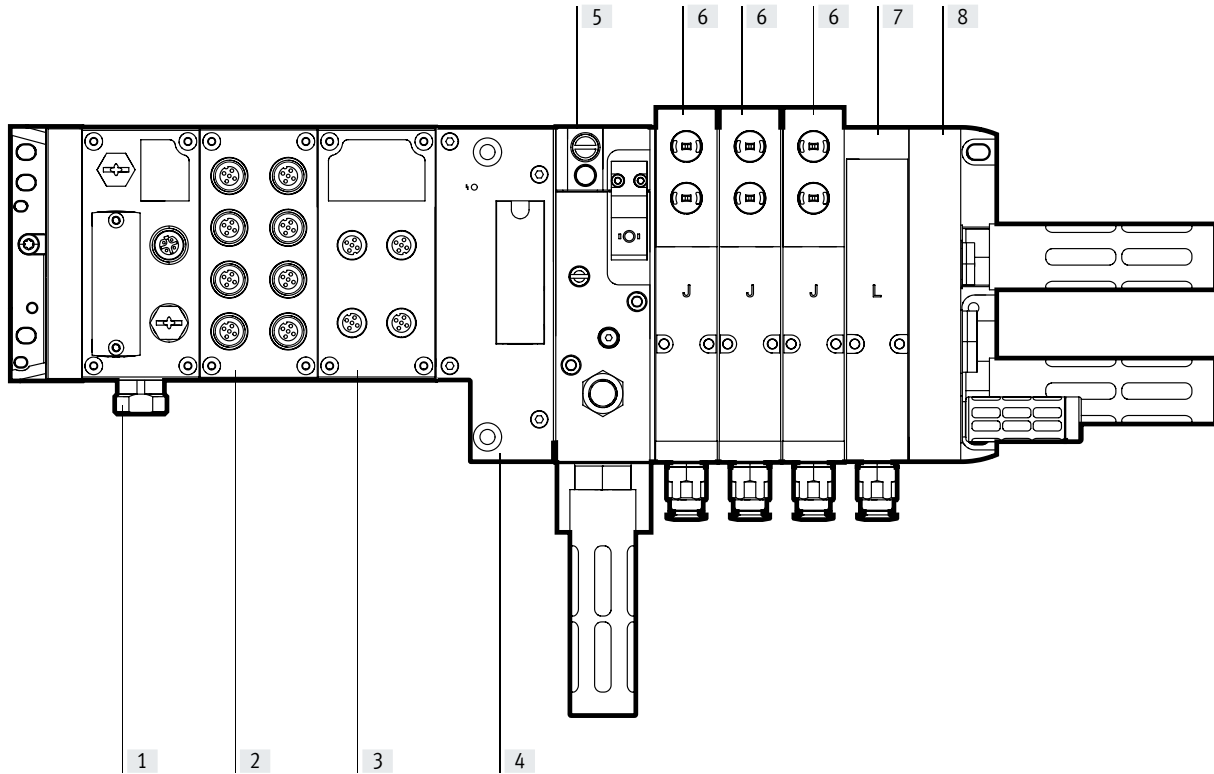

- | | | | |
|---|--|--|--|
| [1] Fieldbus node for EtherNet/IP or Modbus TCP | [4] CPX pneumatic interface | [6] 5/2-way valve, double solenoid (J) | [8] Right end plate (XP2) with supply air/exhaust air, external pilot air supply, blanking plug in duct 1 and 14 |
| [2] Input module (16 digital inputs) | [5] Soft-start valve (PP – internal pilot air) | [7] Vacant position (L) | [8] Right end plate (XP1) with supply air/exhaust air, external pilot air supply, blanking plug in duct 1 |
| [3] Output module (8 digital outputs) | [5] Soft-start valve (PM – external pilot air) | | |

Selection with internal pilot air (PP and XP2):

Selection no. in online catalogue: 539217

Electrical part: 51E-F36GCQPNMKBLX-S+GSBA
 Pneumatic part: 44P-N-XP2-SMPP-BB-3JL+UGBP1

Selection with external pilot air (PM and XP1):

Selection no. in online catalogue: 539217

Electrical part: 51E-F36GCQPNMKBLX-S+GSBA
 Pneumatic part: 44P-N-XP1-SMPM-BB-3JL+UGBP1

Datasheet – Soft-start valve for VTSA/VTSA-F

Practical example 2: Valve terminal VTSA with CPX terminal (metal design), soft-start valve and switching position sensing

With external pilot air (PM and XP2):

Selection no. in the digital customer information system: 539217

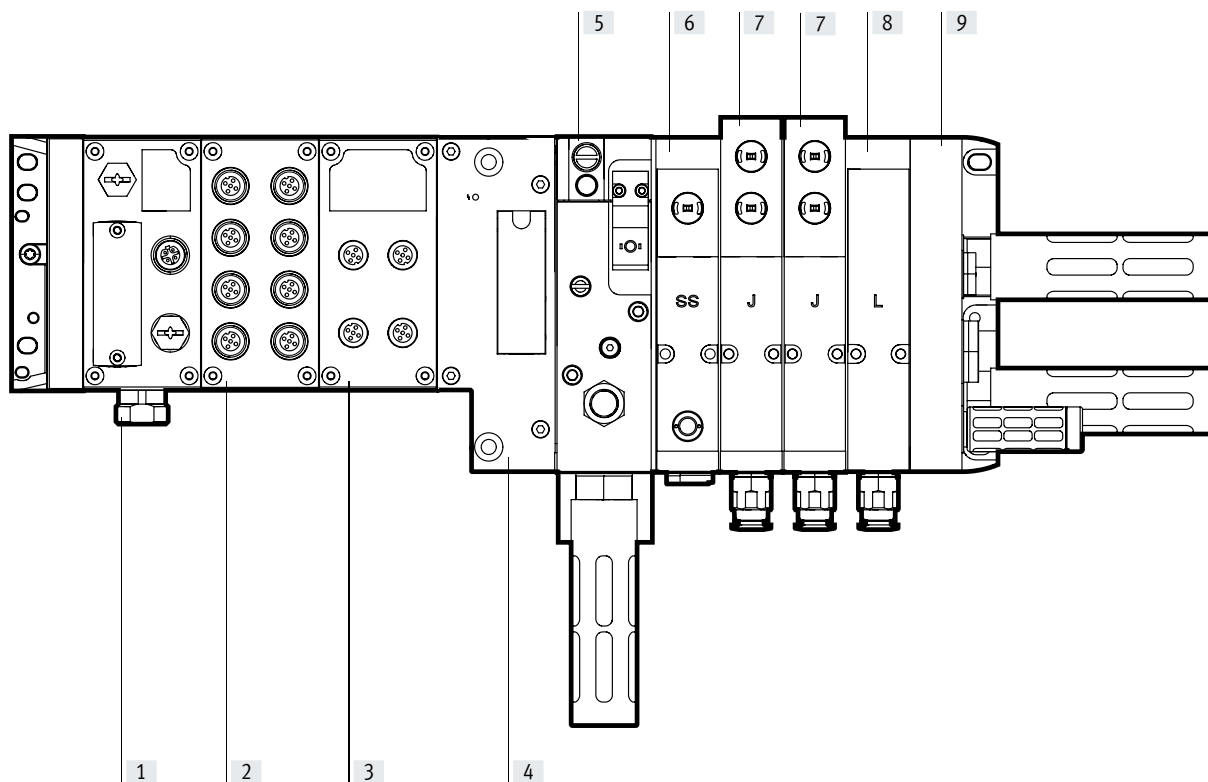

- | | | | |
|---|--|---|--|
| [1] Fieldbus node for EtherNet/IP or Modbus TCP | [4] CPX pneumatic interface | [6] 5/2-way single solenoid valve, spring return, switching status indication with PNP sensor with 0.5 m connecting cable and push-in connector M12x1 (SS), and intermediate plate for switchable pilot air supply (ZO) | [7] 5/2-way double solenoid valve (J), width 26 mm |
| [2] Input module (16 digital inputs) | [5] Soft-start valve (PM – external pilot air) | | [8] Vacant position (L) |
| [3] Output module (8 digital outputs) | | | [9] Right end plate (XP2) with supply air/exhaust air, external pilot air supply, blanking plug in duct 1 and 14 |

Selection with external pilot air (PM and XP2), solenoid valve with switching position sensing (SS) and intermediate plate for switchable pilot air supply (ZO)

Selection no. in online catalogue: 539217

Electrical part: 51E-F36GCQPNMKBLX-S+GSBA

Pneumatic part: 44P-N-XP2-SMPM-BB-SSZOJL+UGCGBP1

Datasheet – Soft-start valve for VTSA/VTSA-F

Practical example 3: Valve terminal VTSA with CPX terminal (metal design), switching position sensing, soft-start valve and 2 pressure zones

With external pilot air (PM and XP2)

Selection no. in the digital customer information system: 539217

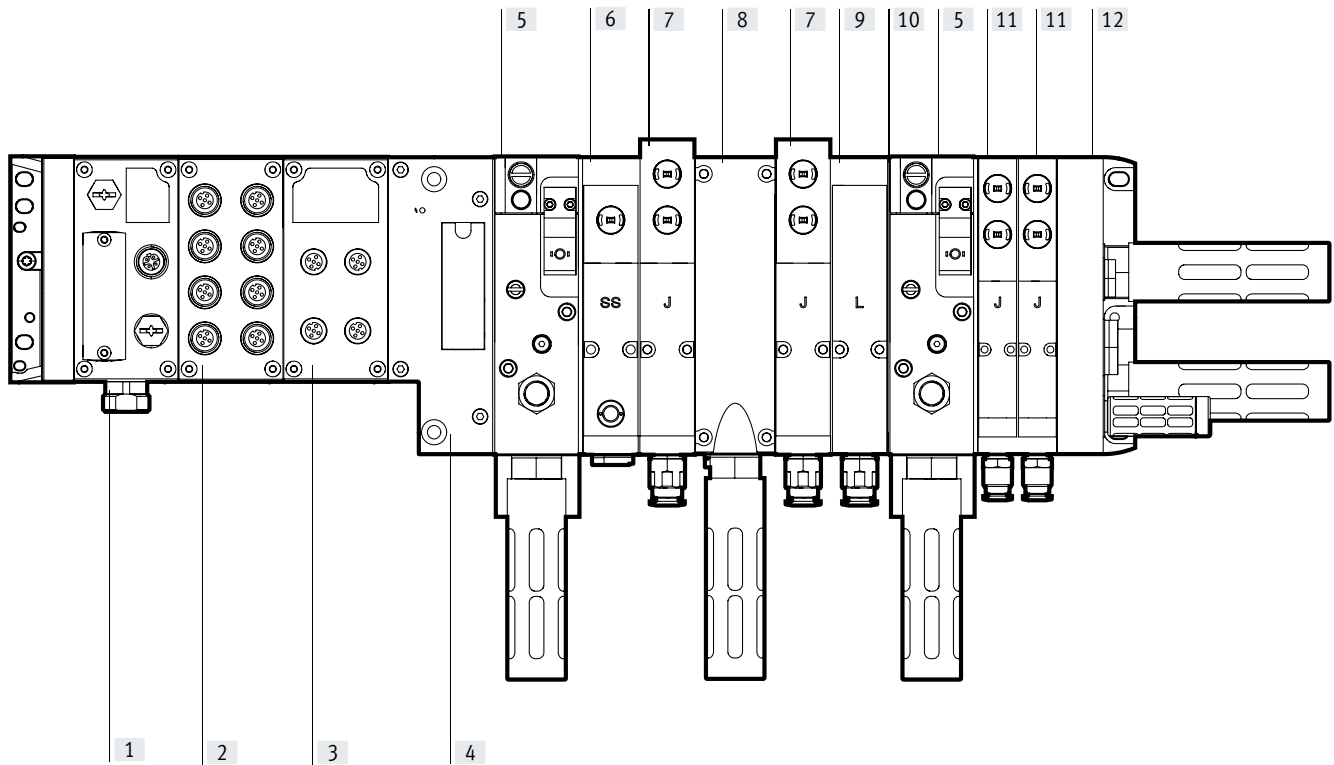

- | | | | |
|---|---|--|---|
| [1] Fieldbus node for EtherNet/IP or Modbus TCP | [5] Soft-start valve for one pressure zone (PM – external pilot air) | [7] 5/2-way double solenoid valve (J), width 26 mm | [11] 5/2-way double solenoid valve (J), width 18 mm |
| [2] Input module (16 digital inputs) | [6] 5/2-way single solenoid valve, spring return, switching status indication with PNP sensor with 0.5 m connecting cable and push-in connector M12x1 (SS), and intermediate plate for switchable auxiliary pilot air supply (ZO) | [8] Exhaust plate (W) for ducts 3/5 | [12] Right end plate (XP2) with supply air/exhaust air, external pilot air supply, blanking plug in duct 1 and 14 |
| [3] Output module (8 digital outputs) | | [9] Vacant position (L) | |
| [4] CPX pneumatic interface | | [10] Duct separation (S) 1, 3, 5 | |

Selection with external pilot air (PM and XP2), solenoid valve with switching position sensing (SS) and intermediate plate for switchable pilot air supply and 2 pressure zones

Selection no. in online catalogue: 539217

Electrical part: 51E-F36GCQPNMKBLX-S+GSBA

Pneumatic part: 44P-N-XP2-LSMPM-BWBSPMA-SSZOJLJLJ+UGCGBP1

Electrical connection of pneumatic components

The solenoid valve with switching position sensing (SS), with sensor connection M12 is connected to the CPX input module using an appropriate connecting cable in order to link the sensor signal to the CPX system.

The soft-start valve (PM – with sensor PNP) is connected to the CPX input module using an appropriate connecting cable (GC) in order to integrate the sensor signal into the CPX system.

A connecting cable (GBP1) to/from the CPX output module is used to control the soft-start valve (PM). (Control signal)

Datasheet – Soft-start valve for VTSA/VTSA-F

Dimensions

Soft-start valve

Download CAD data → www.festo.com

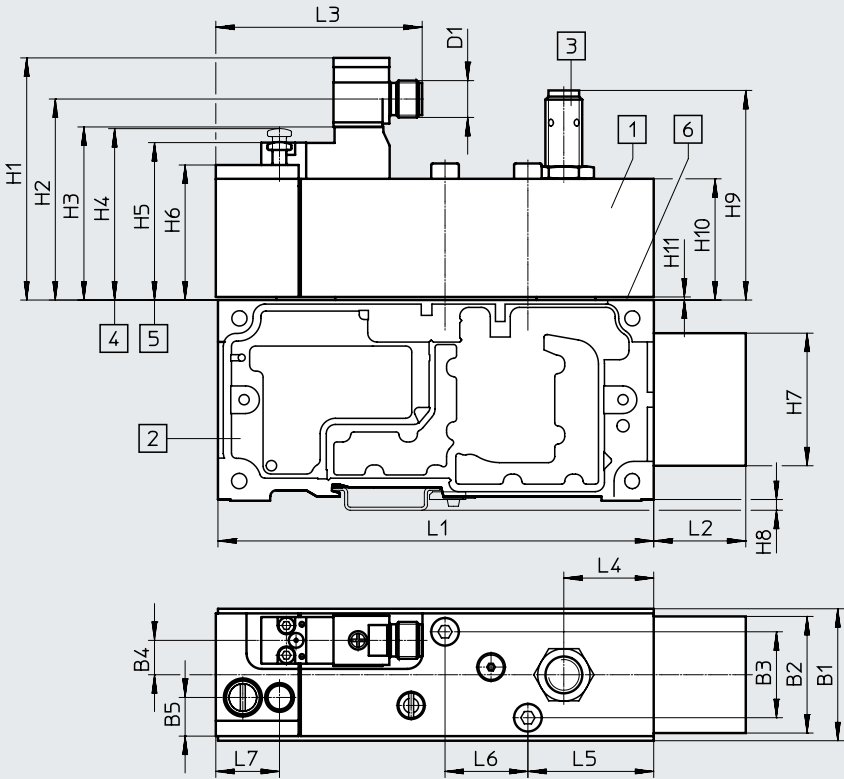

- [1] Soft-start valve, (port pattern to ISO 5599-2)
- [2] Manifold sub-base with connecting adapter (ducts 2 and 4), pneumatic connection G1/2
- [3] Soft-start valve optionally with sensor or protective cap
- [4] Manual override, normal position (unactuated)
- [5] Manual override, switching position (actuated)
- [6] Seal for internal or external pilot air supply of the valve terminal

Type	B1	B2	B3	B4	B5	D1	L1	L2	L3	L4	L5	L6	L7
VABF-S6-1-P5A4-G12-4- ...	43	36.5	28	11.2	12.6	M12x1	142	30	67.3	29.3	41	27	20.8

Type	H1	H2	H3	H4	H5	H6	H7	H8	H9	H10	H11
VABF-S6-1-P5A4-G12-4- ...	78.9	65.5	56.4	55.9	51.5	44	41.2	3.5	68.3	39.5	1

Seal ¹⁾ between soft-start valve and manifold sub-base

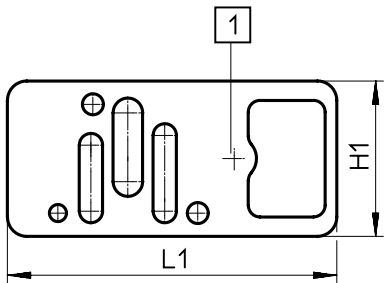
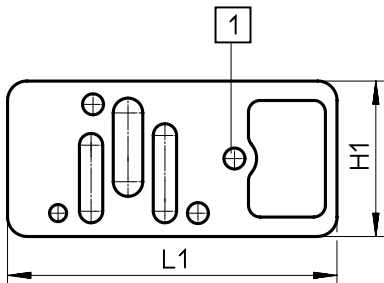







[1] With drilled hole, internal pilot air supply

[1] Without drilled hole, external pilot air supply

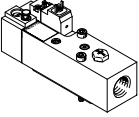

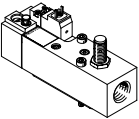

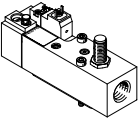

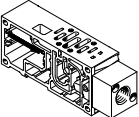
Type	H1	L1
VABD-S6- ...	40	84.8

1) Seals are included with the soft-start valve

Datasheet – Soft-start valve for VTSA/VTSA-F

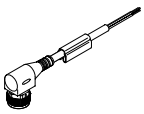
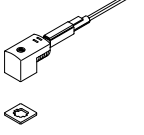
Ordering data					
	Terminal code	Description	Weight [g]	Part no.	Type
Soft-start valve, 24 V DC					
	–	Without sensor output, pneumatic connection G1/2 (with seals for internal and external pilot air)	590	558230	VABF-S6-1-P5A4-G12-4-1
	PN	Seal for external pilot air (without drilled hole)			
	PQ	Seal for internal pilot air (with drilled hole)			
Soft-start valve with sensor output PNP, 24 V DC					
	–	With sensor output PNP, pneumatic connection G1/2 (with seals for internal and external pilot air)	605	557377	VABF-S6-1-P5A4-G12-4-1-P
	PM	Seal for external pilot air (without drilled hole)			
	PP	Seal for internal pilot air (with drilled hole)			
Soft-start valve with sensor output NPN, 24 V DC					
	–	With sensor output NPN, pneumatic connection G1/2 (with seals for internal and external pilot air)	605	558233	VABF-S6-1-P5A4-G12-4-1-N
	PK	Seal for external pilot air (without drilled hole)			
	PO	Seal for internal pilot air (with drilled hole)			
Manifold sub-base					
	–	Suitable for a soft-start valve (ports for ducts 2 and 4 are combined), pneumatic connection G1/2	570	556989	VABV-S6-1-Q-G12

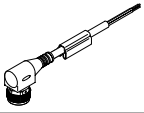
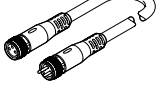
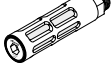
Accessories – Soft-start valve for VTSA/VTSA-F

Ordering data					
Designation	Code	Description	Part no.	Type	
Cover cap					
	–	M12, for sealing the sensor opening	10 pieces	165592	ISK-M12
Electrical connection for soft-start valve					
	P1	<ul style="list-style-type: none"> • Angled socket, type C, 2-pin, with LED • Straight plug, 1xM12, 2-pin • 24 V DC 		188024	MSSD-EB-M12-MONO
	GB	<ul style="list-style-type: none"> • Straight socket, 1xM12, 5-pin • Open end, 4-core 	5 m	541328	NEBU-M12G5-K-5-LE4
	–	<ul style="list-style-type: none"> • Angled socket, 1xM12, 5-pin • Open end, 4-core 	5 m	541329	NEBU-M12W5-K-5-LE4
	GG	<ul style="list-style-type: none"> • Angled socket, type C, 3-pin, with LED 	2.5 m	151688	KMEB-1-24-2.5-LED
	GH	<ul style="list-style-type: none"> • Open end, 3-core 	5 m	151689	KMEB-1-24-5-LED
	GJ	<ul style="list-style-type: none"> • 24 V DC, PVC 	10 m	193457	KMEB-1-24-10-LED
	GK	<ul style="list-style-type: none"> • Angled socket, type C, 3-pin 	2.5 m	151690	KMEB-1-230AC-2.5
	GL	<ul style="list-style-type: none"> • Open end, 3-core • 230 V AC, PVC 	5 m	151691	KMEB-1-230AC-5
Connecting cable for electrical connection of the proximity switch					
	–	<ul style="list-style-type: none"> • Straight socket, 1xM12, 5-pin • Open end, 4-core 	5 m	541328	NEBU-M12G5-K-5-LE4
	GC	<ul style="list-style-type: none"> • Angled socket, 1xM12, 5-pin • Open end, 4-core 	5 m	541329	NEBU-M12W5-K-5-LE4
	–	Modular system for a choice of connecting cables		–	NEBU-... → Internet: nebu
Silencer					
	U	Standard design, connecting thread (1 piece)	G1/2	6844	U-1/2-B
	A	Sintered design, connecting thread (10 pieces)	G1/2	1205863	AMTE-M-LH-G12
Pneumatic connection accessories					
A selection of possible fittings, blanking plugs, silencers and other pneumatic accessories can be found in the chapter Accessories → page: 246 or on the website via the individual search terms: Internet → connection technology, silencer, blanking plug					

Datasheet – Soft-start valve for VTSA-F-CB



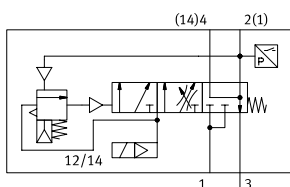

Function

Without manual override

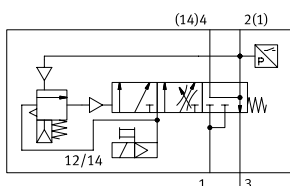

With manual override



-  - Flow rate
Pressurisation:
3000 l/min
Exhausting: 3300 l/min
-  - Module width
41 mm
-  - Temperature range
-5 ... +50°C
-  - Operating pressure
2 ... 10 bar
0.2 ... 1 MPa



Description

Smart valve functions

The basic functions are the same as for the familiar soft-start valve.

There is a variant with internal pilot air supply (code PM) and a variant without internal pilot air supply (code PN). In addition, the new smart soft-start valve has:

- An integrated pressure sensor for sensing the exhausted position
- A revised design of the manual override with protection against unintended actuation, as well as an automatic reset

Like the familiar soft-start valve, its purpose is to slowly and safely build up the supply pressure in duct 1 of the valve terminal or to quickly exhaust it. Switch-on takes place in two stages:

- First the working pressure for duct 1 gradually increases (the speed can be adjusted using a flow control screw).

- Once the working pressure in duct 1 reaches half the operating pressure, the soft-start valve switches to full operating pressure at duct 1 of the valve terminal.

The switching point is permanently set at 50% of the operating pressure. The full operating pressure is applied at duct 14 (pilot air) at all times. This pressure causes the valves on the valve terminal to immediately move to the required switching position, so an unspecified position is not possible.

Duct 1 of the valve terminal is exhausted via the soft-start valve's exhaust port only in the normal position, when the valve is not switched. The exhaust air can optionally be ducted with fittings for compressed air tubing with standardised O.D. or using a silencer. A detenting manual override with self-reset via an electrical control signal is available for maintenance and service purposes.

Safety characteristics

Max. positive test pulse with logic 0	[µs]	2000
Max. negative test pulse with logic 1	[µs]	1200
Shock resistance		Shock test with severity level 2, to EN 60068-2-27
Vibration resistance		Transport application test with severity level 2, to EN 60068-2-6

Datasheet – Soft-start valve for VTSA-F-CB

General technical data	
Design	Piston spool valve
Grid dimension [mm]	41
Valve size [mm]	40
Overlap	Negative overlap
Actuation type	Electrical
Sealing principle	Soft
Type of mounting	On sub-base
Mounting position	Any
Valve function	Soft-start and exhaust function
Manual override	Detenting, self-resetting via electrical control signal (part numbers 8067407 and 8067405), normal position on top → page 209
Manual override	None (part numbers 8067411 and 8067409)
Reset method	Mechanical spring
Type of actuation	Piloted
Pilot air supply	For soft-start valve: always internal via valve terminal For valve terminal: internal via soft-start valve (part nos. 8067407, 8067411) For valve terminal: internal, not via soft-start valve (part nos. 8067405, 8067409)
Flow direction	Not reversible
Pneumatic connection 3	G1/2
MTTF, subcomponent	452 years, pressure switch

Standard nominal flow rate [l/min]	
Pressurisation	3000
Note on pressurisation	MPA: 1200 VTSA: 3000
Exhausting	3300
Note on exhausting	MPA: 1600 VTSA: 3300

Operating and environmental conditions			
Type	VABF-S6-1-P5A4S1-...		VABF-S6-1-P5A4S2-...
Operating medium	Compressed air to ISO 8573-1:2010 [7:4:4]		
Pilot medium	Compressed air to ISO 8573-1:2010 [7:4:4]		
Notes on operating/ pilot medium	Lubricated operation not possible		
Pilot pressure	[bar]	3 ... 10	2 ... 10
	[MPa]	0.3 ... 1	0.2 ... 1
Operating pressure	[bar]	3 ... 10	2 ... 10
	[MPa]	0.3 ... 1	0.2 ... 1
Relative humidity	Max. 90% at 40°C		
Ambient temperature [°C]	-5 ... +50		
Temperature of medium [°C]	-5 ... +50		
Storage temperature [°C]	-20 ... +60		
Corrosion resistance class CRC ¹⁾	0		

1) Corrosion resistance class CRC 0 to Festo standard FN 940070

No corrosion stress. Applies to small, visually unimportant standards-based parts such as threaded pins, circlips and clamping sleeves which are usually only available on the market in a phosphated or burnished version (and possibly oiled) as well as to ball bearings (for components < CRC 3) and plain bearings.

Datasheet – Soft-start valve for VTSA-F-CB

Electrical data for soft-start valve

Electrical actuation	Fieldbus
Electrical connection	Plug-in
Nominal operating voltage [V]	24 DC
Operating voltage range [V]	24 DC ±10%
Characteristic coil data	24 V DC: 1.6 W
Permissible voltage fluctuations [%]	±10%
Degree of protection to EN 60529	IP65 (for all types of signal transmission when mounted)
Pressure sensor	Integrated (plug-in)
Sensor evaluation	Internal
Switching element function	N/C
Switching position sensing	Via pressure switch, exhausted status
Signal status display	Yellow LED, valve control Green LED, pressure switch, exhausted status
Duty cycle [%]	100

Materials

	Soft-start valve	Manifold sub-base
Housing	Wrought aluminium alloy	Die-cast aluminium
Seals	NBR, HNBR	–
Screws	Galvanised steel	–
Note on materials	RoHS-compliant	

Connection and display components

Soft-start valve VABF-S6-1-P5A4-... with manifold sub-base

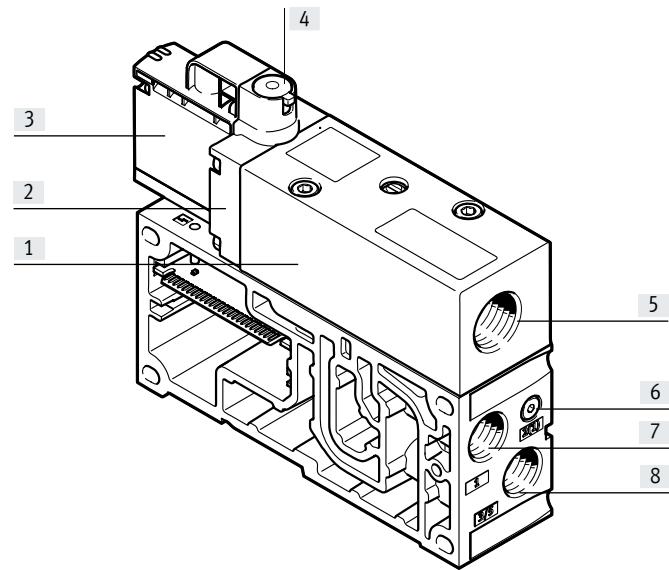

- [1] Basic valve housing
- [2] Intermediate plate
- [3] Pilot control
- [4] Manual override (MO) (optional)
- [5] Exhaust air port for duct 1
- [6] Pressure sensing for duct 1
- [7] Compressed air supply port
- [8] Exhaust air port for duct 3/5

Note

Detailed information on the manual override can be found in the user documentation.

→ Internet: User documentation

Datasheet – Soft-start valve for VTSA-F-CB

Valve function		
Terminal code	Circuit symbol	Description
PM		<ul style="list-style-type: none"> • Soft-start valve with pilot air supply • Soft-start valve with manual override (MO)
PM		<ul style="list-style-type: none"> • Soft-start valve with pilot air supply • Soft-start valve without manual override (MO)
PN		<ul style="list-style-type: none"> • Soft-start valve without pilot air supply • Soft-start valve with manual override (MO)
PN		<ul style="list-style-type: none"> • Soft-start valve without pilot air supply • Soft-start valve without manual override (MO)

Datasheet – Soft-start valve for VTSA-F-CB

Dimensions

Download CAD data → www.festo.com

Soft-start valve with manifold sub-base

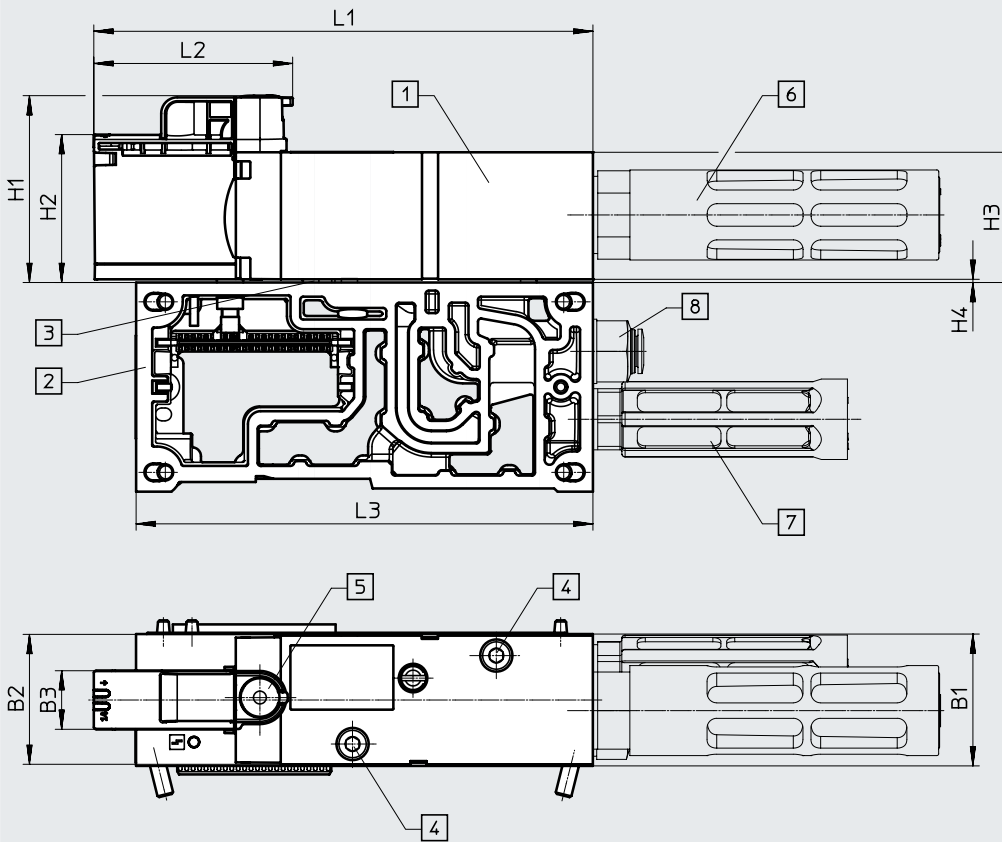

- [1] Soft-start valve
- [2] Manifold sub-base, pneumatic connection G3/8
- [3] Seal
- [4] Socket head screw M5x45 for manifold sub-base (captive)
- [5] Manual override, self-resetting (code: YE) or concealed (code: S)
- [6] Silencer, connection size G1/2
- [7] Silencer, connection size G3/8
- [8] Fitting connection size G3/8

Type	B1	B2	B3	H1	H2	H3	H4	L1	L2	L3
VABF-S6-1-P5A4...-G12-1T5-PA	41	40.4	18.2	58.1	46	40.5	1	155.1	60.3	142

Seal ¹⁾ between soft-start valve and manifold sub-base

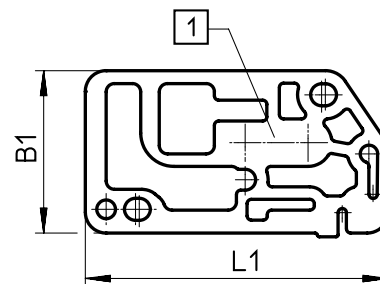
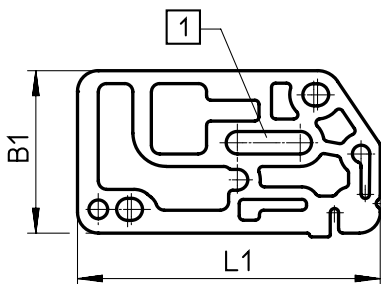

[1] With elongated hole, internal pilot air supply

[1] Without elongated hole, external pilot air supply

Type	B1	L1
VABF-S6-1-P5A4Z ...	39	72.7

1) Seals are included with the soft-start valve

Accessories – Soft-start valve for VTSA-F-CB

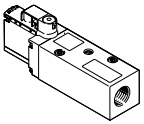
Ordering data										
	Code	Description	Operating pressure		Standard nominal flow rate ¹⁾		Wt. [g]	Part no.	Type	
			[MPa]	[bar]	Pressurisation [l/min]	Exhausting [l/min]				
Soft-start valve, without manifold sub-base										
	PM	Pilot pressure build-up from duct 1 (S1)	Manual override (MO), self-resetting	0.3 ... 1	3 ... 10	3000	3300	466	8067407	VABF-S6-1-P5A4S1YE-G12-1T5-PA
			Manual override (MO), concealed	0.3 ... 1	3 ... 10	3000	3300	466	8067411	VABF-S6-1-P5A4S1S-G12-1T5-PA
	PN	No pilot pressure build-up from duct 1 (S2)	Manual override (MO), self-resetting	0.2 ... 1	2 ... 10	3000	3300	466	8067405	VABF-S6-1-P5A4S2YE-G12-1T5-PA
			Manual override (MO), concealed	0.2 ... 1	2 ... 10	3000	3300	466	8067409	VABF-S6-1-P5A4S2S-G12-1T5-PA

1) +/- 15% to FN 942032

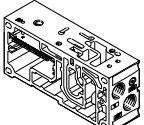
Ordering data						
	Code	Description	Wt. [g]	Part no.	Type	
Manifold sub-base for soft-start valve						
	PV	<ul style="list-style-type: none"> • With CBUS loop-through • Sensor evaluation: internal • Duct 3/5 combined • Only in combination with pneumatic interface with voltage zone • Pneumatic connection G3/8 	421	8068609	VABV-S6-1Q-G38-CB1-T5	

Datasheet – Pneumatic interface for VTSA-F-CB

-  - Voltage
24 V DC



Description

Up to three safe voltage zones can be formed in the pneumatic part of the valve terminal using the pneumatic interface.

There is also a variant available which uses a safe voltage zone as an external output.

The pneumatic interfaces (zone extensions) can be placed centrally in the pneumatic section of a valve terminal VTSA-F-CB and they extend the valve terminal by up to 3 additional (safe) voltage zones.

Function

Two different equipment levels:

- Formation of up to three safe internal voltage zones
- Formation of up to two safe internal voltage zones and one safe external voltage zone

- Integrated driver levels for addressing up to 24 valves within the first safe voltage zone

- Integrated diagnostics on short circuit and overload of the controlled valve coils

- Integrated diagnostics for load voltage undervoltage

Datasheet – Pneumatic interface for VTSA-F-CB

General technical data	
Type	VABA-S6-1-X2-3V-CB-AL
Max. no. of valve positions	12 with double solenoid valves
	24 with single solenoid valves
Product weight [g]	1388
Electrical data	
Type	VABA-S6-1-X2-3V-CB-AL
Electrical connection	3x M12x1, A-coded
	5-pin
	Plug
	Via CPX
Operating voltage range [V DC]	21.6 ... 26.4
Intrinsic current consumption at nominal operating voltage [mA]	Typically 11 (operating voltage supply for electronics)
	Typically 45 (load voltage supply for valves)
Max. power supply per channel [A]	0.2
Max. aggregate current per module [A]	6
Nominal operating voltage [V DC]	24
Degree of protection	IP65
	NEMA 4
Operating and environmental conditions	
Type	VABA-S6-1-X2-3V-CB-AL
Ambient temperature [°C]	-5 ... 50
Materials	
Type	VABA-S6-1-X2-3V-CB-AL
Note on materials	RoHS-compliant
Information on materials: Housing	Die-cast aluminium
Information on materials: Cover	PA
Corrosion resistance class CRC	0 ¹⁾
LABS (PWIS) conformity	VDMA24364-B1/B2-L

1) Corrosion resistance class CRC 0 to Festo standard FN 940070

No corrosion stress. Applies to small, visually unimportant standard parts such as threaded pins, circlips and clamping sleeves which are usually only available on the market in a phosphated or burnished version (and possibly oiled) as well as to ball bearings (for components < CRC 3) and plain bearings.

Datasheet – Pneumatic interface for VTSA-F-CB

General technical data		
Type	VABA-S6-1-X2-F1-CB-AL	VABA-S6-1-X2-F1-CB2-AL
Max. no. of valve positions	12 with double solenoid valves	12 with double solenoid valves
	24 with single solenoid valves	24 with single solenoid valves
Product weight [g]	1542	1576
Electrical data		
Type	VABA-S6-1-X2-F1-CB-AL	VABA-S6-1-X2-F1-CB2-AL
I/O output, function	–	Power supply, valve
I/O output, connection type	–	Plug
I/O output, connection technology	–	7/8" round plug connector
I/O output, number of pins	–	5
Electrical connection	Via CPX	Via CPX
Operating voltage range [V DC]	21.6 ... 26.4	21.6 ... 26.4
Intrinsic current consumption at nominal operating voltage [mA]	Typically 15 El. w/o CPX-FVDA-P2	Typically 15 El. w/o CPX-FVDA-P2
	Typically 25 El. with CPX-FVDA-P2	Typically 25 El. with CPX-FVDA-P2
Max. power supply per channel [A]	0.2	0.2
Max. aggregate current per module [A]	2	2
Nominal operating voltage [V DC]	24	24
Degree of protection	IP65	IP65
Operating and environmental conditions		
Type	VABA-S6-1-X2-F1-CB-AL	VABA-S6-1-X2-F1-CB2-AL
Storage temperature [°C]	–20 ... 60	–
Ambient temperature [°C]	–	–5 ... 50
Vibration resistant	Transport application test with severity level 2 to FN 942017-4 and EN 60068-2-6	Transport application test with severity level 2 to FN 942017-4 and EN 60068-2-6
Shock resistance	Shock test with severity level 2 to FN 942017-5 and EN 60068-2-27	Shock test with severity level 2 to FN 942017-5 and EN 60068-2-27
Materials		
Type	VABA-S6-1-X2-F1-CB-AL	VABA-S6-1-X2-F1-CB2-AL
Note on materials	RoHS-compliant	
Information on materials: Sub-base	Die-cast aluminium	
Information on materials: Cover	PA	
Information on materials: Screws	Steel	
Information on materials: Seals	NBR	
Corrosion resistance class CRC	0 ¹⁾	
CE marking	To EU EMC Directive ²⁾	
	To EU RoHS Directive ²⁾	

- 1) Corrosion resistance class CRC 0 to Festo standard FN 940070
No corrosion stress. Applies to small, visually unimportant standard parts such as threaded pins, circlips and clamping sleeves which are usually only available on the market in a phosphated or burnished version (and possibly oiled) as well as to ball bearings (for components < CRC 3) and plain bearings.
- 2) For information about the area of use, see the EC declaration of conformity at: www.festo.com/catalogue/... → Support/Downloads.
If the devices are subject to usage restrictions in residential, commercial or light-industrial environments, further measures for the reduction of the emitted interference may be necessary.

Datasheet – Pneumatic interface for VTSA-F-CB

General technical data		
Type	VABA-S6-1-X2-F2-CB-AL	VABA-S6-1-X2-F2-CB2-AL
Max. no. of valve positions	12 with double solenoid valves	12 with double solenoid valves
	24 with single solenoid valves	24 with single solenoid valves
Product weight [g]	1562	1596

Electrical data		
Type	VABA-S6-1-X2-F2-CB-AL	VABA-S6-1-X2-F2-CB2-AL
I/O output, function	Safe digital output	
I/O output, connection type	Socket	
I/O output, connection technology	M12x1, A-coded to EN 61076-2-101	
I/O output, number of pins	5	
I/O valve, function	–	Power supply, valve
I/O valve, connection type	–	Plug
I/O valve, connection technology	–	7/8" round plug connector
I/O valve, number of pins	–	5
Electrical connection	Via CPX	
Operating voltage range [V DC]	21.6 ... 26.4	
Intrinsic current consumption at nominal operating voltage [mA]	Typically 15 El. w/o CPX-FVDA-P2	
	Typically 25 El. with CPX-FVDA-P2	
Max. power supply per channel [A]	0.2	
Max. aggregate current per module [A]	2	
Nominal operating voltage [V DC]	24	
Degree of protection	IP65	

Operating and environmental conditions		
Type	VABA-S6-1-X2-F2-CB-AL	VABA-S6-1-X2-F2-CB2-AL
Storage temperature [°C]	–	–20 ... 60
Ambient temperature [°C]	–5 ... 50	
Vibration resistant	Transport application test with severity level 2 to FN 942017-4 and EN 60068-2-6	Transport application test with severity level 2 to FN 942017-4 and EN 60068-2-6
Shock resistance	Shock test with severity level 2 to FN 942017-5 and EN 60068-2-27	Shock test with severity level 2 to FN 942017-5 and EN 60068-2-27

Materials		
Type	VABA-S6-1-X2-F2-CB-AL	VABA-S6-1-X2-F2-CB2-AL
Note on materials	RoHS-compliant	
Information on materials: Sub-base	Die-cast aluminium	
Information on materials: Cover	PA	
Information on materials: Screws	Steel	
Information on materials: Seals	NBR	
Corrosion resistance class CRC	0 ¹⁾	
CE marking	To EU EMC Directive ²⁾	
	To EU RoHS Directive ²⁾	

- 1) Corrosion resistance class CRC 0 to Festo standard FN 940070
No corrosion stress. Applies to small, visually unimportant standard parts such as threaded pins, circlips and clamping sleeves which are usually only available on the market in a phosphated or burnished version (and possibly oiled) as well as to ball bearings (for components < CRC 3) and plain bearings.
- 2) For information about the area of use, see the EC declaration of conformity at: www.festo.com/catalogue/... → Support/Downloads.
If the devices are subject to usage restrictions in residential, commercial or light-industrial environments, further measures for the reduction of the emitted interference may be necessary.

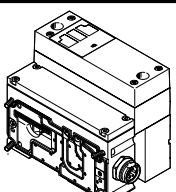

Ordering data				
	Code	Description	Part no.	Type
	XB	Pneumatic interface for extending by 3 external voltage zones	8152438	VABA-S6-1-X2-3V-CB-AL
	XC	Pneumatic interface for extending by 3 safe internal zones (PROFIsafe)	8152437	VABA-S6-1-X2-F1-CB-AL
	XD	Pneumatic interface for extending by 2 safe internal zones + 1 safe output (PROFIsafe)	8152436	VABA-S6-1-X2-F2-CB-AL
	PC	Pneumatic interface with additional power supply for extending by 3 safe internal zones (PROFIsafe)	8152435	VABA-S6-1-X2-F1-CB2-AL
	PD	Pneumatic interface with additional power supply for extending by 2 safe internal zones + 1 safe output (PROFIsafe)	8152434	VABA-S6-1-X2-F2-CB2-AL

Datasheet – Vacuum block for VTSA/VTSA-F

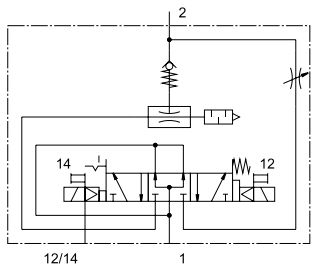
Function



Vacuum Ejection

-  - Vacuum block width
53 mm
-  - Voltage
24 V DC
-  - Operating pressure
4 ... 8 bar
0.4 ... 0.8 MPa

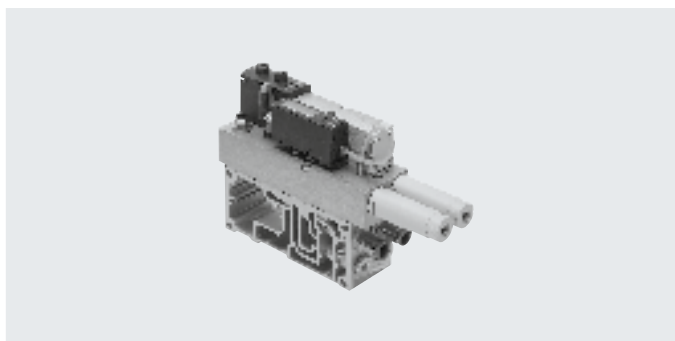

Description

The vacuum block can be integrated into the existing valve terminal VTSA/VTSA-F. To do this, the vacuum block is screwed to a manifold sub-base for 2 valve positions, width 26 mm.

The vacuum block is used in conjunction with a suction gripper to pick up, hold and place components. Picking up and holding is carried out by a suction gripper using a vacuum.

Once the component has been positioned, it is released by an ejector pulse. This ejector pulse is created by pressurising the vacuum system so that the vacuum briefly collapses. The ejector pulse can be set.

 **Note**
The vacuum block can be operated in combination with the vertical stacking for pilot air switch-off (intermediate plate VABF-S4-1-S plus 5/2-way valve) on the valve terminal VTSA/VTSA-F.

Function

The vacuum block VABF-S4-1-V2B1... is used to generate a vacuum. The generated vacuum and a suction gripper produce a force which is used to grip and transport a workpiece. The supply of compressed air for vacuum generation is controlled by a solenoid valve. The vacuum is generated by actuating solenoid coil 12.

The setpoint value set at duct B for the generated vacuum is monitored via a vacuum sensor (with switching output). Vacuum generation reverts to a self-holding phase after reaching the setpoint value. The vacuum block controls the vacuum generation process independently within the range of the set switching points (air saving function).

The integrated solenoid valve is used to generate an ejector pulse by activating coil 14. The workpiece is thus safely released from the suction cup with connector and the vacuum is rapidly reduced. The length of the ejector pulse can be influenced by the duration of the electrical pulse. The strength of the ejector pulse is influenced by the adjustable flow control.

 **Note**
If the electrical or pneumatic supply fails while the valve is in the "generate vacuum" or "air saving" state, the valve moves to the "generate vacuum" position.

Operating mode of the air saving function (LS)

If the desired threshold value (1) (turn off suction) is reached for the vacuum, vacuum generation is automatically switched off.

Check valves prevent the reduction of the vacuum. However, leakages (e.g. due to rough workpiece surfaces) will slowly reduce the vacuum.

If the vacuum drops below the set threshold value (2) (turn on suction), vacuum generation is switched on automatically.

Vacuum is generated until the set threshold value (1) (turn off suction) is reached again.

Threshold value to turn off suction (air saving function) (1):

The vacuum generator is switched off simultaneously when the output Out A is set.

The preset value is -700 mbar.

Threshold value to turn on suction (2):

The threshold value (2) should always be above the switching point of duct B (3) "vacuum sensing".

The gap between (2) and (3) should be at least 50 mbar.

Note

Setting options and further instructions are described in the operating instructions and/or documentation VABF-S4-1-V2B1... on the Support Portal from Festo.

Datasheet – Vacuum block for VTSA/VTSA-F

General technical data		
Valve function	5/3-way, pressurised	
Design	Non-modular	
Mounting position	Any	
Nominal width of Laval nozzle (vacuum generation)	[mm]	2.0
Ejector characteristics	High vacuum, standard	
Integrated functions	<ul style="list-style-type: none"> • Ejector pulse valve, electric • Flow control valve • On/off valve, electric • Air-saving circuit, electric • Non-return valve • Open silencer • Vacuum switch 	
Silencer design	Open	
Measured variable	Relative pressure	
Measuring principle	Piezoresistive	
Switching function	Threshold value comparator	
Short circuit current rating	Yes	
Reverse polarity protection	For all electrical connections	
Inductive protective circuit	Adapted to MZ, MY, ME coils	
Switching element function	N/O	
Threshold value setting range	[bar]	–0.999 ... 0 (recommended operating range: –0.95 ... –0.05)
	[MPa]	–0.0999 ... 0 (recommended operating range: –0.095 ... –0.005)
Hysteresis setting range	[bar]	–0.9 ... 0
	[MPa]	–0.09 ... 0
Power supply, vacuum block	Via own plug M12	
Pneumatic supply for vacuum block	Via valve terminal VTSA/VTSA-F	
Ejector pulse	Strength adjustable via flow control screw	
Actuation type <ul style="list-style-type: none"> • Solenoid valve • Vacuum block 	Electrically actuated Vacuum generation via Venturi nozzle	
Type of actuation for solenoid valve	Piloted	
Flow direction	Not reversible	
Exhaust function	Can be throttled (duct 3 and 5)	
Type of mounting	Via through-hole, screwed onto manifold sub-base, width 26 mm	
Manual override <ul style="list-style-type: none"> • For vacuum generation • For ejector pulse 	Detenting, non-detenting, concealed Yes, solenoid coil 12 (holding) Yes, solenoid coil 14 (spring return), (only effective when power supply is switched off)	
Signal status display, valve	LED	
Pneumatic connections		
Supply	1, 3	Via the manifold sub-base of the valve terminal, width 26 mm
Exhausting	3/5	Via the modular silencer for vacuum block
Working port (vacuum port)	2	Via the manifold sub-base of the valve terminal (QS push-in fitting – vacuum), G1/4
Connection	4	Via the manifold sub-base of the valve terminal (sealed with blanking plug type B-1/4)

Datasheet – Vacuum block for VTSA/VTSA-F

Technical data for pressure switch of vacuum block (delivery status)

Duct A: air saving function		
Switching behaviour		Threshold value comparator
Switching point	[mbar]	-700
	[MPa]	-0.07
Hysteresis	[mbar]	200
	[MPa]	0.02
Switching characteristic		NO (normally open contact)
Duct B: vacuum sensing		
Switching behaviour		Threshold value comparator
Switching point	[mbar]	-400
	[MPa]	-0.04
Hysteresis	[mbar]	5
	[MPa]	0.0005
Switching characteristic		NO (normally open contact)

Note
 Setting options for duct A and duct B and further instructions can be found on the Support Portal from Festo in the operating instructions and/or documentation VABF-S4-1-V2B1...

Electrical data

Electrical connection		4-pin plug to ISO 15407-2 (vacuum block supplied with power separately, not via valve terminal)
Nominal operating voltage	[V DC]	24
Operating voltage range	[V DC]	21.6 ... 26.4
Duty cycle	[%]	100
Max. output current	[mA]	50
Voltage drop	[V]	≤1.5
No-load supply current	[mA]	50 ... 150 (dependent on the switching status of the solenoid coils)
Characteristic coil data	[V DC]	24
Power consumption (Characteristic coil data)	[W]	1.3
Overload protection		Available
Accuracy (full scale)	[% FS]	±3
Degree of protection to EN 60529		IP65, NEMA 4 (for all types of signal transmission when mounted)

Electrical connection¹⁾

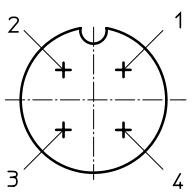
	1xM12 plug, 4-pin to EN 61076-2-101	Pin1 – + 24 V DC (brown (BN)) Pin2 – Out B (white (WH)) Pin3 – 0 V DC (blue (BU)) Pin4 – Out A (black (BK))	Supply voltage Switching output B (duct B) 0 V DC Switching output A (duct A)
---	-------------------------------------	--	--

1) Max. permissible signal cable length: 5 m

Datasheet – Vacuum block for VTSA/VTSA-F

Operating and environmental conditions		
Operating medium		Compressed air to ISO 8573-1:2010 [7:4:4]
Notes on the operating medium		Unlubricated operation
Operating pressure	[bar]	4 ... 8
	[MPa]	0.4 ... 0.8
Nominal operating pressure	[bar]	6
	[MPa]	0.6
Pressure measuring range	[bar]	-1 ... 0
	[MPa]	-0.1 ... 0
Partial vacuum	[bar]	Up to approx. 0.9 (as a function of operating pressure)
	[MPa]	Up to approx. 0.09 (as a function of operating pressure)
Ambient temperature	[°C]	0 ... 50
Temperature of medium	[°C]	0 ... 50
Noise level LpA (at nominal operating pressure)	[dB(A)]	78

Materials	
Housing, jet nozzle	Wrought aluminium alloy
Screws	Galvanised steel
Seals	NBR
Plug housing	Nickel-plated die-cast zinc
Plug contacts	Gold-plated brass
Inspection window on pressure sensor	PA
Pressure sensor keypad	TPE-U
Note on materials	RoHS-compliant
PWIS conformity	VDMA24364 zone III

Pressure ratios, air consumption and volumetric flow rate

Vacuum as a function of operating pressure

Air consumption as a function of operating pressure

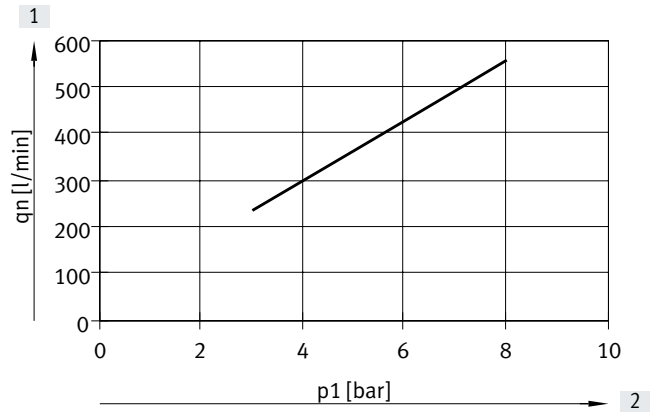
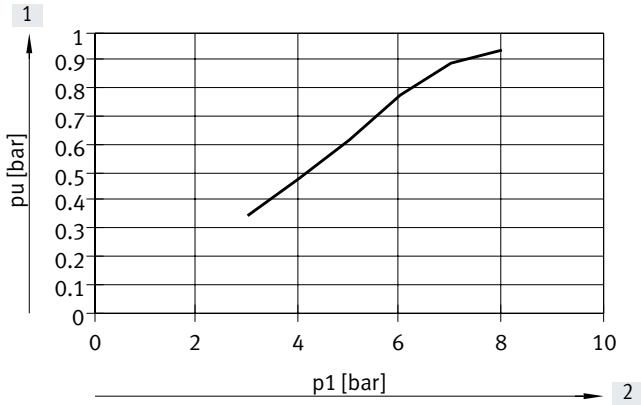

[1] Vacuum

[2] Operating pressure

[1] Air consumption

[2] Operating pressure

Datasheet – Vacuum block for VTSA/VTSA-F

Dimensions

Download CAD data → www.festo.com

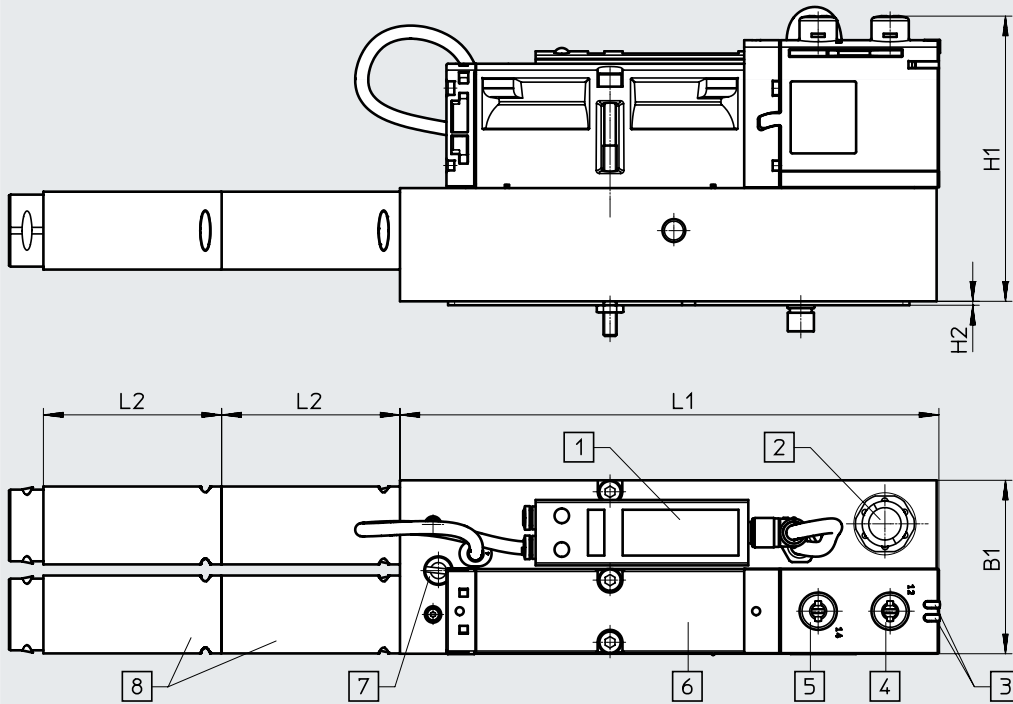

- [1] Pressure sensor with LCD display and operating buttons
- [2] Plug for electrical connection and vacuum sensing (M12, 4-pin)
- [3] LED signal status indication, solenoid valve
- [4] Manual override for vacuum generation
- [5] Manual override for ejector pulse (only effective when the power supply is switched off)
- [6] Solenoid valve
- [7] Flow control screw for adjusting the strength of the ejector pulse
- [8] Modular silencer

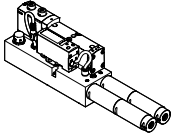
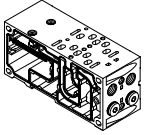
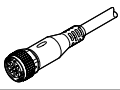
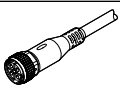
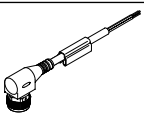
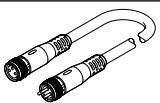

Type	B1	H1	H2	L1	L2
VABF-S4-1-V2B1-C-VH-20	53	87.1	1.2	164.7	54.2

Datasheet – Vacuum block for VTSA/VTSA-F

Ordering data				
	Code	Description	Part no.	Type
Vacuum block				
	VB	Vacuum block for valve terminal VTSA/VTSA-F with air-saving function and adjustable ejector pulse	1120 g	571425 VABF-S4-1-V2B1-CVH-20
Manifold sub-base				
	L ²⁾	For vacuum block 2 valve positions, 4 addresses, with 2 blanking plugs in port 4	26 mm	– ¹⁾ VABV-S4-...
	LK ²⁾	For vacuum block 2 valve positions, 4 addresses, with 2 blanking plugs in port 4, with small QS fitting	26 mm	– ¹⁾ VABV-S4-...
Connecting cable				
	–	• Straight socket, 1xM12, 5-pin • Open end, 4-core	2.5 m	550326 NEBU-M12G5-K-2.5-LE4
	–	• Straight socket, 1xM12, 5-pin • Open end, 4-core	5 m	541328 NEBU-M12G5-K-5-LE4
	GC	• Angled socket, 1xM12, 5-pin • Open end, 4-core	5 m	541329 NEBU-M12W5-K-5-LE4
	–	Modular system for a choice of connecting cables	–	NEBU-... → Internet: nebu
Pneumatic connection accessories				
A selection of possible fittings, blanking plugs, silencers and other pneumatic accessories can be found in the chapter Accessories → page: 246 or on the website via the individual search terms: Internet → connection technology, silencer, blanking plug				

- 1) The manifold sub-base for use with the vacuum block can only be ordered via the valve terminal configurator and therefore doesn't have a separate part number.
2) Code letter within the order code for a valve terminal configuration

Datasheet – Vacuum generator for VTSA-F-CB

-  Vacuum generator width
35 mm
-  Voltage
24 V DC
-  Operating pressure
4 ... 8 bar
0.4 ... 0.8 MPa

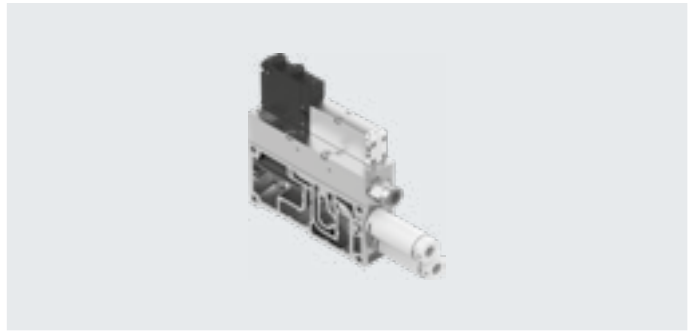

Description

The vacuum generator VABF is designed for generating a vacuum. The vacuum generator can be integrated into the existing valve terminal VTSA-F-CB.

Compressed air as well as power are supplied via the valve terminal.

A solenoid valve (solenoid coil 12, vacuum generation) controls the compressed air supply. Vacuum is generated using the Venturi principle when the vacuum generator is pressurised with compressed air.

The vacuum generator is used in conjunction with a suction gripper to pick up, hold and place components.

Picking up and holding is carried out by a suction gripper using a vacuum. Once the component has been positioned, it is released by an ejector pulse. The ejector pulse can be set.

The ejector pulse is generated using the solenoid valve (solenoid coil 14, ejector pulse). The vacuum collapses if the vacuum system is briefly pressurised.

The power ejector pulse variant (-AP) of the vacuum generator is a more energy- and air-saving option.

Extended functions with VTSA-F-CB

The VTSA-F-CB with serial communication provides the vacuum generator with extended functions:

- Opening and saving of up to four records (on a local computer)
- Teach-in functionality: recording homing runs, from gripping and holding the workpiece to setting it down. Configuration of switching points and monitoring.
- Preventive maintenance: measurement of all vacuum times, comparison with the homing run, warning message if a definable level of deviation is reached
- Switching air-saving function on/off
- Changing the vacuum parameters per record
- Locking the ejector pulse:
 - When the Uval of the adjacent voltage zone is switched off (voltage zone with safe shut-off within the valve terminal)
 - When there is a fault with the valve load voltage (e.g. undervoltage)
- Extended diagnostic functions via CBUS and display of status LED (yellow) or error LED (red)

Note

In the event of an "emergency off" of the valve terminal (shutdown U_{VAL}), the vacuum generator VABF remains in vacuum generation mode with air-saving function.

If there is a complete power failure (bus shutdown, U_{SEN}) when the vacuum generator is in "Generate vacuum" mode, the valve switches to the "Permanent suction" position.

Vacuum generation

The vacuum is generated according to the Venturi principle using the vacuum generator cartridges VN.

For the large sizes 20 and 30, two vacuum generator cartridges are used and connected in parallel.

For size 14, one vacuum generator cartridge is used (the second port is sealed with a blanking plug).

Vacuum generation is activated when the output signal "vacuum generation" is applied for at least 50 ms. Since the vacuum generation is pulse-controlled, vacuum is also generated after the output signal is deactivated.

Datasheet – Vacuum generator for VTSA-F-CB

Function overview

Monitoring process parameters

- Pressure value at vacuum port
- Limit values
- Evacuation time t_E
- Pressurisation time t_B
- Process quality

Static teach-in

Switching points and cycle time can be configured using the FMT (Festo Maintenance Tool).

Dynamic teach-in

Calculating and optimising existing process sequences. Switching points and monitoring functions can be configured during operation.

Pressure value (vacuum)

Pressure values are measured continuously between the vacuum port and filter. If the operating voltage of the vacuum generator is switched off, the values are reset.

Cycle time

The time from the start of the evacuation through ejection to the start of the new evacuation.

Fault detection and diagnostic messages

- Supply voltage not reached
- Evacuation time exceeded
- Fault on air-saving function
- Vacuum value not reached
- Evacuation or pressurisation time exceeded
- Process quality below limit value
- Teach-in error

Air saving function

- Is set at the factory.
- Can be switched off for "air-permeable workpieces" (otherwise there will be an unnecessarily high number of switching processes).

Manual override

Both solenoid coils, for vacuum generation and ejector pulse, can be switched manually using the manual override.

Evacuation and pressurisation time

The evacuation time t_E is measured from the start of the evacuation until the switching point is reached. The pressurisation time t_B is measured from the start of the pressurisation to the time at which the pressure value (vacuum) falls below -5 kPa.

Blanking plug

A vacuum generator V*20 or V*30 can be converted at a later date to V*14 using a blanking plug OASC-V1-P. This makes it possible to reduce the air consumption or reduce the suction rate (e.g. for evacuation of smaller volumes).

Emergency stop function

If the emergency stop (switching off the load voltage supply) is triggered during vacuum generation, the vacuum generator remains in vacuum generation mode.

If the air saving function was activated, it remains active. If the parameter "ejector pulse interlock" is activated (set to inactive at the factory), no ejector pulse is triggered in the event of an emergency stop.

If there is a complete power failure (electronic supply voltage) during vacuum generation, the valve switches to "generate vacuum" position.

When the power supply is switched on again, the valve remains in the "generate vacuum" operating status until an ejection signal is received.

Error state

If communication between the controller and the vacuum generator is interrupted, a specific status is set.

The following settings are defined in this state:

- Output bit "vacuum generation" is set to 0.
- Output bit "ejector pulse" is set to 0.
- Parameter set is set to 0
- Air saving function is not affected

Additional characteristics

- Galvanic isolation between the vacuum generator VABF and valve terminal VTSA-F-CB
- 3 performance settings for vacuum generation (14, 20, 30)
- Integrated solenoid valve for vacuum generation (solenoid coil 12) and ejector pulse (solenoid coil 14)
- Air-saving ejector pulse with increased ejecting rate (power ejector pulse)
- Flow control screw to adjust the ejector impulse
- Integrated pressure sensor
- Integrated air saving function
- Integrated strainer for filtering process air in order to protect the vacuum generator [-AP]
- Switching of the solenoid valve for vacuum generation with mechanical manual override
- Open silencer for reduced noise levels
- A check valve prevents purging of the vacuum if vacuum generation is interrupted

Datasheet – Vacuum generator for VTSA-F-CB

General technical data		
Type	Functions with type code VABF...-A	
Type	Functions with type code VABF...-AP	
Valve function	5/3-way, pressurised	
Design	Non-modular	
Mounting position	Any	
Nominal width of Laval nozzle (vacuum generation)	14 [mm]	1.4
	20 [mm]	2.0
	30 [mm]	3.0
Ejector characteristics	• VABF..V2B1...VH...	
	• VABF..V2B1...VL...	
Ejector characteristics	High vacuum, standard	
	High suction rate, standard	
Integrated functions	<ul style="list-style-type: none"> • Ejector pulse, electrical • Flow control valve • On/off valve, electric • Air-saving circuit, electric • Non-return valve • Open silencer • Vacuum switch 	<ul style="list-style-type: none"> • Power ejector pulse, electrical • Flow control valve • On/off valve, electric • Air-saving circuit, electric • Non-return valve • Open silencer • Vacuum switch
Silencer design	Open	
Measured variable	Relative pressure	
Measuring principle	Piezoresistive	
Switching function	Window comparator	
	Threshold value comparator	
Reverse polarity protection	For all electrical connections	
Switching element function	N/O	
Pneumatic supply for vacuum generator	Via valve terminal VTSA-F-CB	
Ejector pulse	Strength adjustable via flow control screw	
Solenoid valve actuation type	Electrically actuated	
Type of actuation for solenoid valve	Piloted	
Flow direction	Not reversible	
Type of mounting	Via through-hole, screwed onto manifold sub-base, width 35 mm	
Manual override	Non-detenting (only non-detenting: with accessories), detenting, covered (with accessories)	
	• For vacuum generation Yes, solenoid coil 12 (holding)	
	• For ejector pulse Yes, solenoid coil 14 (spring return), (only effective when power supply is switched off)	
Pneumatic connections		
Supply	1	Compressed air is supplied via the valve terminal
Exhausting	3	Via silencer (open)
Working port (vacuum port)	2	G3/8
Electrical data and sensors		
Operating voltage range (UB)	[V DC]	21.6 ... 30
Nominal operating voltage	[V DC]	24
Duty cycle	[%]	100
No-load supply current	[mA]	30
Electrical actuation	Fieldbus	
Electrical connection	Via CPX	
Pressure measuring range	[bar]	-1 ... 0
	[MPa]	-0.1 ... 0
Accuracy (full scale)	[% FS]	±3
Reproducibility, switching value FS	[%]	1
Degree of protection to EN 60529	IP65	
Protection class to DIN EN 61140	III	

Datasheet – Vacuum generator for VTSA-F-CB

Display and operation	
Display type	LED display, 2-digit
Threshold value setting range [kPa]	0 ... 99
Hysteresis setting range [kPa]	0 ... 90
Setting options	Teach-in Via parameter sets
Switching status display sensor	LED
Display range start value [kPa]	0
Display range end value [kPa]	99
Displayable unit(s) [kPa]	Vacuum
Signal status indication, solenoid valve	LED

Operating and environmental conditions		VH-14-A	VH-14-AP	VH-20-A	VH-20-AP	VH-30-A	VH-30-AP	VL-14-A	VL-14-AP	VL-20-A	VL-20-AP	
Type VABF...												
Operating medium	Compressed air to ISO 8573-1:2010 [7:4:4]											
Note on operating/pilot medium	Lubricated operation not possible											
Pilot pressure pS [bar]	4 ... 10											
	[MPa]	0.4 ... 1										
Operating pressure pB [bar]	4 ... 8											
	[MPa]	0.4 ... 0.8										
Nominal operating pressure pBnom [bar]	6											
	[MPa]	0.6										
Operating pressure for max. suction rate [bar]	4		4		6		4		5			
	[MPa]	0.4		0.4		0.6		0.4		0.5		
Operating pressure for max. vacuum pumax [bar]	4		4		6		–		–			
	[MPa]	0.4		0.4		0.6		–		–		
Max. vacuum pVmax [kPa]	92											
Max. suction rate with respect to atmosphere [l/min]	51			99			167			91		179
Pressurisation time at nominal operating pressure [s]	0.2	0.3	0.2	0.3	0.2	0.25	0.2	0.25	0.2	0.25		
Noise level LpA (at nominal operating pressure) [dB(A)]	70		73		75		62		61			
Ambient temperature tamb [°C]	–5 ... +50											
Temperature of medium tmed [°C]	–5 ... +50											
CE marking (see declaration of conformity)	To EU EMC Directive											
Certification	RCM											
Corrosion resistance class CRC ¹⁾	0											

1) Corrosion resistance class CRC 0 to Festo standard FN 940070

No corrosion stress. Applies to small, visually unimportant standards-based parts such as threaded pins, circlips and clamping sleeves which are usually only available on the market in a phosphated or burnished version (and possibly oiled) as well as to ball bearings (for components < CRC 3) and plain bearings.

Materials	
Housing, jet nozzle, blanking plug	Wrought aluminium alloy
Adjusting screw	High-alloy stainless steel
Screws	Steel
Vacuum generator seals	NBR, HNBR
Blanking plug seals	NBR
Plate	Die-cast aluminium
Collector nozzle	POM
Silencers	PU foam, POM
Note on materials	RoHS-compliant (vacuum generator and blanking plug)
Corrosion resistance class CRC ¹⁾	2 (blanking plug)

1) Corrosion resistance class CRC 2 to Festo standard FN 940070

Moderate corrosion stress. Indoor applications in which condensation can occur. External visible parts with primarily decorative surface requirements that are in direct contact with a normal industrial environment.

Datasheet – Vacuum generator for VTSA-F-CB

Connection and display components

Vacuum generator VABF-S4-... - CB-VH/VL-...

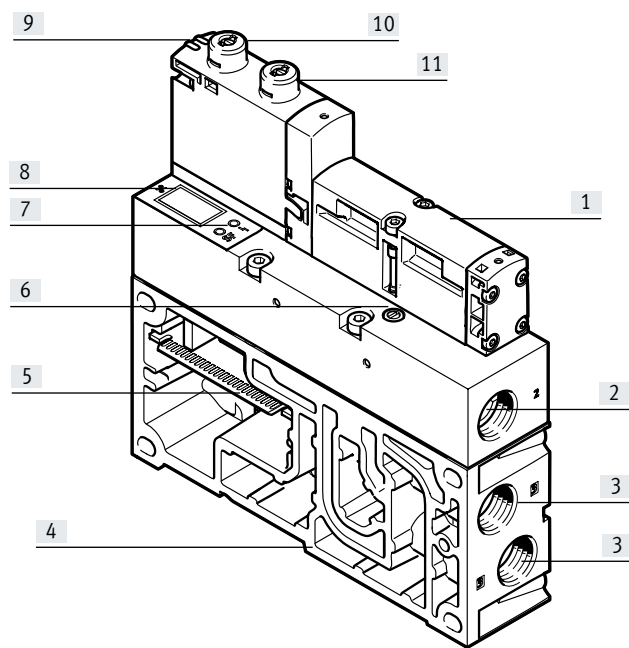

- [1] Solenoid valve VSVA
- [2] Vacuum port G3/8
- [3] Port for silencer UOM-3/8 [VH/L-14 (1x) and VH-20 (2x)]
- [4] Manifold sub-base for valve terminal VTSA-F-CB (pneumatic and electric)
- [5] Electrical link to valve terminal VTSA-F-CB
- [6] Flow control screw for adjusting the strength of the ejector pulse
- [7] The status LED (yellow) indicates the operating status of the vacuum generator and displays warnings in the event of a process fault
- [7] The error LED (red) indicates the status of the CBUS connection and displays errors
- [8] The 7-segment display (2-digit blue LED display) shows the pressure value (vacuum) in kPa
- [9] LED switching status indication for solenoid valve
- [10] Manual override for vacuum generation
- [11] Manual override for ejector pulse

Diagnostics and monitoring

The vacuum generator has monitoring functions that enable malfunctions or faults to be detected at an early stage during operation.

- Monitoring tE (evacuation time), reference via teach-in
- Monitoring tB (pressurisation time), reference via teach-in
- Monitoring air consumption via vacuum drop rate VDR (process quality) when air saving function is active (tLS)

The following diagnostic functions are possible:

Definition of diagnostic levels

Status	Normal operation	Warning	Faults
Definition	Device is OK	Outside the specification	Malfunction

Operating statuses of the vacuum generator

Actuation		Function/operating status	Comment
Solenoid coil 12	Solenoid coil 14		
0	0	Normal position	No actuation or status after the end of the "ejection" signal/the "pressurisation" function
		Generating vacuum	Operating status after failure of the pilot air supply or the electrical supply of the vacuum generator (self-latching loop)
1	0	Generating vacuum	Pulse actuation with self-latching loop
0	1	Pressurising (ejector pulse)	Accelerated vacuum reduction
1	1	Saving air (air saving function)	Maintain vacuum (valve mid-position)

Datasheet – Vacuum generator for VTSA-F-CB

Electrical and pneumatic status changes		
Status change	Operating status before status change	Operating status after status change
Failure/deactivation of the electronics supply or the pilot air supply of the vacuum generator	Generating vacuum	Generating vacuum (The valve spool remains in the "generate vacuum" position)
	Saving air	Generating vacuum (The mechanical spring pushes the valve spool into the "generate vacuum" position)
	Pressurising	Normal position ¹⁾
	Normal position ¹⁾	Normal position ¹⁾
Emergency stop/switch-off of the load voltage supply	Generating vacuum	Generating vacuum
	Saving air	Generating vacuum (vacuum is maintained)
	Pressurising	Normal position or function is interrupted ²⁾
	Normal position ¹⁾	Normal position ¹⁾

- 1) Normal position means the vacuum block is not in the "generate vacuum", "air saving" or "ejection" operating status
 2) Parameter "ejector pulse interlock" must be active

Note

If the compressed air or power supply to the valve terminal fails, this will result in the following statuses:

- Compressed air failure:
 - No vacuum can be generated, even if the valve is in the "generate vacuum" position.
 - No ejector pulse can be generated, even if the valve is in the "ejection" position.
- Power supply failure to the valve terminal:
 - If both solenoid coils are de-energised at the same time, the valve switches to permanent suction because of the pilot air volume still present and remains in this state.

Circuit symbols, vacuum generator

VABF..V2B1...A

VABF..V2B1...AP

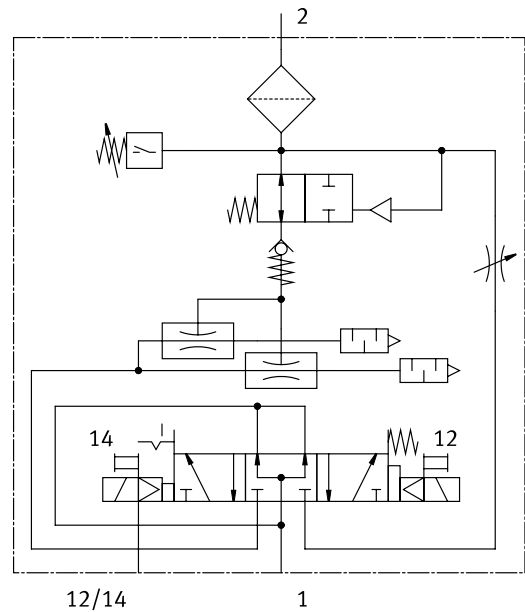
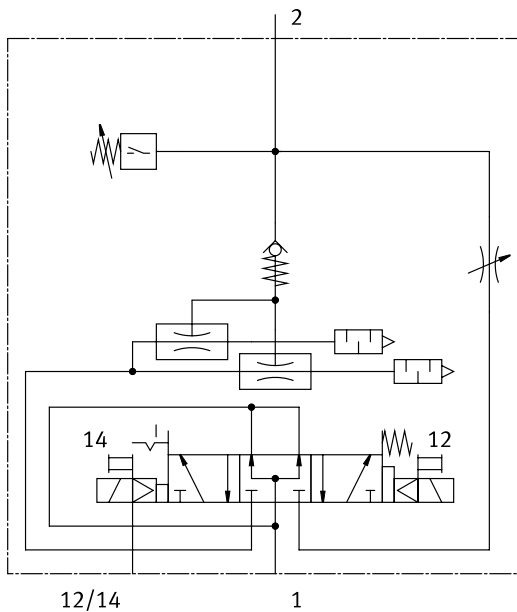

The vacuum generator is supplied internally via duct 1 of the manifold sub-base of the valve terminal.
 The pilot air is supplied internally via duct 12/14 of the manifold sub-base of the valve terminal.

Datasheet – Vacuum generator for VTSA-F-CB

Pressure ratios, negative pressure p_u as a function of operating pressure p_1

VH-1 4/20/30

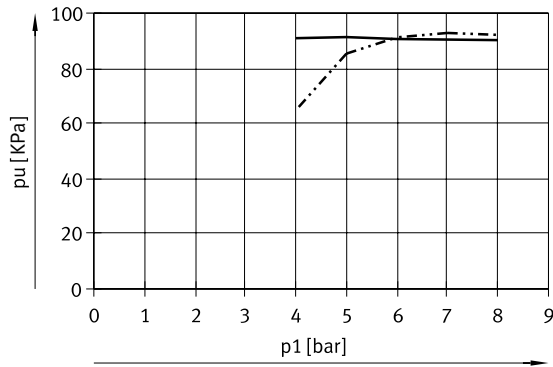

VL-1 4/20

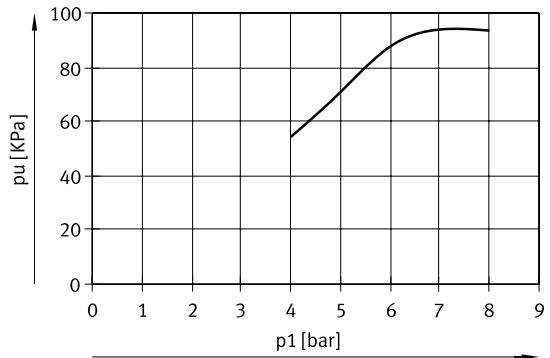

— VH-14/20
- · - · - VH-30

— VL-14/20

Pressure ratios, evacuation time t_{evac} as a function of negative pressure p_u and operating pressure 4 bar for 1 l volume

VH-1 4/20/30: $t_{evac}(p_1)$

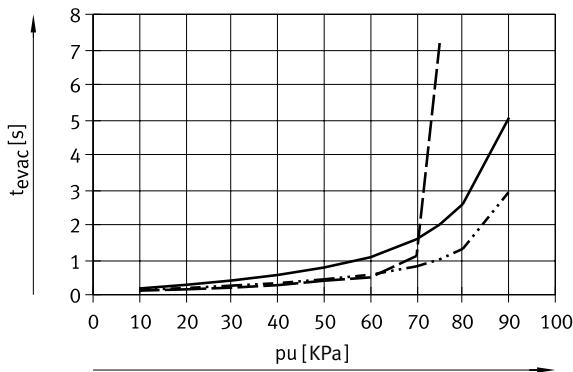

VL-1 4/20: $t_{evac}(p_1)$

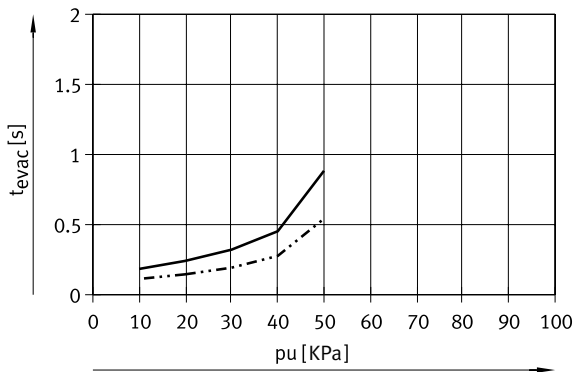

— VH-14
- · - · - VH-20
- - - - VH-30

— VL-14
- · - · - VL-20

Pressure ratios, air consumption q_n as a function of operating pressure p_1

V...-14/20/30

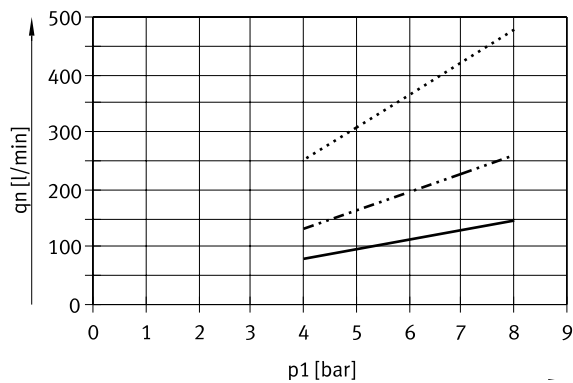

— VH/L-14
- · - · - VH/L-20
- - - - VH-30

Datasheet – Vacuum generator for VTSA-F-CB

Pressure ratios, suction rate q_{ns} as a function of negative pressure p_u , p_1 and operating pressure 6 bar
 VH-1 4/20/30 VL-1 4/20

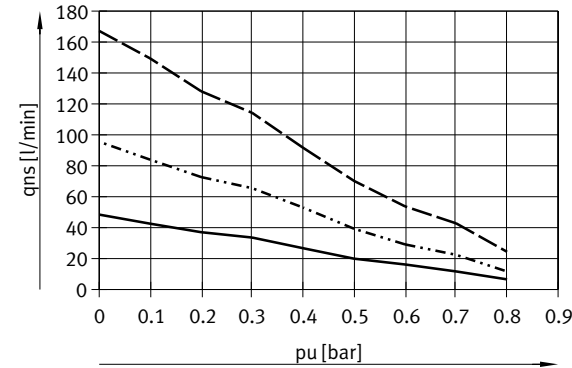

- VH-14
- · - · - · VH-20
- - - - - VH-30

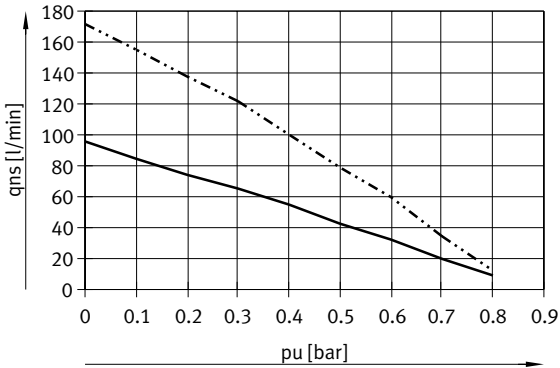

- VL-14
- · - · - · VL-20

Datasheet – Vacuum generator for VTSA-F-CB

Dimensions

Download CAD data → www.festo.com

Vacuum generator Laval nozzle 2.0 with high negative pressure

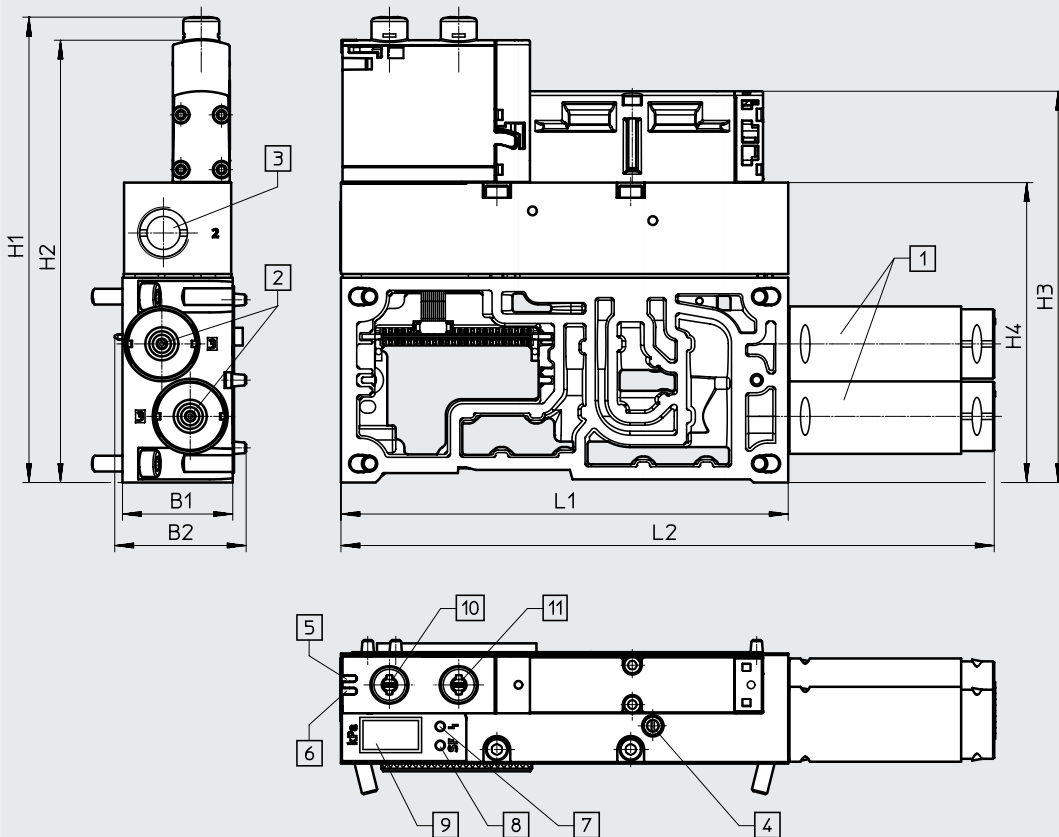

- [1] Silencer UOM-3/8
- [2] Exhaust port G3/8
- [3] Vacuum port G3/8
- [4] Flow control screw for adjusting the strength of the ejector pulse
- [5] LED switching status indication for solenoid valve ejector pulse
- [6] LED switching status indication for solenoid valve vacuum generation
- [7] Fault LED (red)
- [8] Status LED (yellow)
- [9] 2-digit 7-segment display (blue LEDs) for vacuum
- [10] Manual override for vacuum generation, non-detenting/detenting
- [11] Manual override for ejector pulse, non-detenting/detenting

Type	B1	B2	H1	H2	H3	H4	L1	L2
VABFS4-2-V2B1-G38-CB-VH-20-A...	35	41.7	147.7	140.4	124.2	95.2	142	207.4

Note
 Silencer UOM-3/8, seal VABD-S6-1-C and screws for manifold sub-base are included with the order for the vacuum generator.
 If required, the silencer extension UOMS-3/8 can be ordered separately.

Datasheet – Vacuum generator for VTSA-F-CB

Download CAD data → www.festo.com

Dimensions

Vacuum generator Laval nozzle 3.0 and Laval nozzle 2.0 with high suction rate

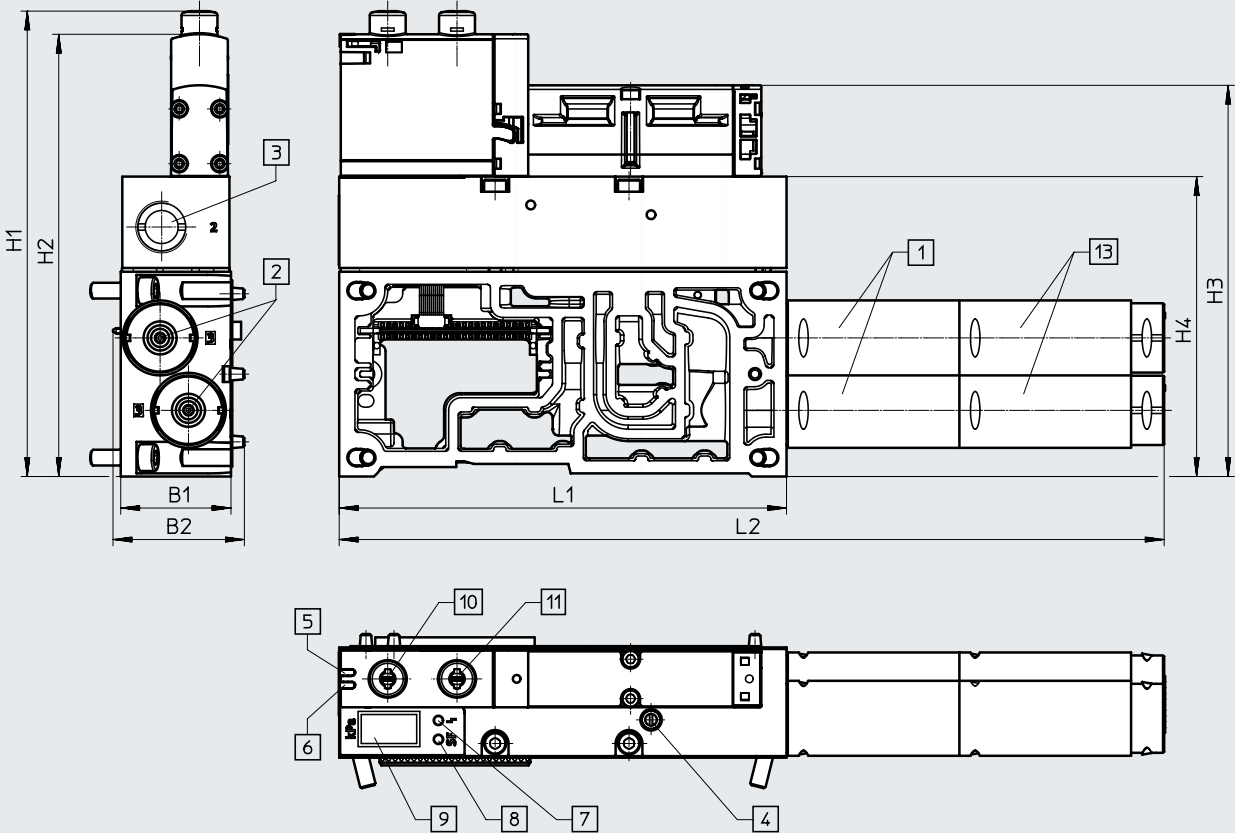

- [1] Silencer UOM-3/8
- [2] Exhaust port G3/8
- [3] Vacuum port G3/8
- [4] Flow control screw for adjusting the strength of the ejector pulse
- [5] LED switching status indication for solenoid valve ejector pulse
- [6] LED switching status indication for solenoid valve vacuum generation
- [7] Fault LED (red)
- [8] Status LED (yellow)
- [9] 2-digit 7-segment display (blue LEDs) for vacuum
- [10] Manual override for vacuum generation, non-detenting/detenting
- [11] Manual override for ejector pulse, non-detenting/detenting
- [13] Silencer extension UOMS-3/8

Type	B1	B2	H1	H2	H3	H4	L1	L2
VABF-S4-2-V2B1-G38-CB-VL-20-A...	35	41.7	147.7	140.4	124.2	95.2	142	261.9
VABF-S4-2-V2B1-G38-CB-VH-30-A...								

Note
 Silencer UOM-3/8, seal VABD-S6-1-C and screws for manifold sub-base are included with the order for the vacuum generator.
 If required, the silencer extension UOMS-3/8 can be ordered separately.

Datasheet – Vacuum generator for VTSA-F-CB

Dimensions

Download CAD data → www.festo.com

Vacuum generator Laval nozzle 1.4

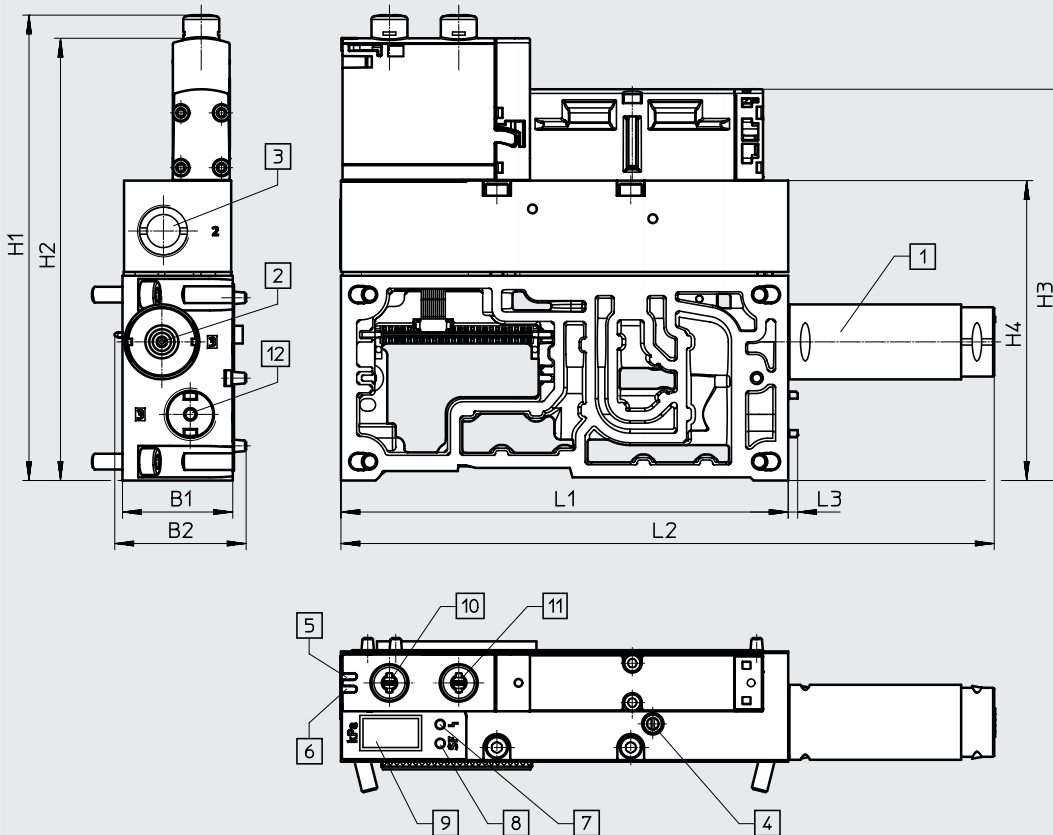



- [1] Silencer UOM-3/8
- [2] Exhaust port G3/8
- [3] Vacuum port G3/8
- [4] Flow control screw for adjusting the strength of the ejector pulse
- [5] LED switching status indication for solenoid valve ejector pulse
- [6] LED switching status indication for solenoid valve vacuum generation
- [7] Fault LED (red)
- [8] Status LED (yellow)
- [9] 2-digit 7-segment display (blue LEDs) for vacuum
- [10] Manual override for vacuum generation, non-detenting/detenting
- [11] Manual override for ejector pulse, non-detenting/detenting
- [12] Screw-in blanking plug (max. tightening torque 4 Nm)

Type	B1	B2	H1	H2	H3	H4	L1	L2	L3
VABF-S4-2-V2B1-G38-CB-VL-14-A...	35	41.7	147.7	140.4	124.2	95.2	142	207.4	3
VABF-S4-2-V2B1-G38-CB-VH-14-A...									

Note
 Silencer UOM-3/8, seal VABD-S6-1-C and screws for manifold sub-base are included with the order for the vacuum generator.
 If required, the silencer extension UOMS-3/8 can be ordered separately.

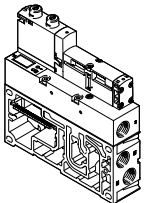
Datasheet – Vacuum generator for VTSA-F-CB

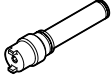
Ordering data						
	Terminal code	Description		Part no.	Type	
Vacuum generator for VTSA-F-CB, with integrated sensor						
	With high suction rate					
	II	Laval nozzle, 1.4 mm	915 g	8088779	VABF-S4-2-V2B1-G38-CB-VL-14-A	
	IIPH	Laval nozzle, 1.4 mm with power ejector pulse	930 g	8088781	VABF-S4-2-V2B1-G38-CB-VL-14-AP	
	IV	Laval nozzle, 2.0 mm	955 g	8067141	VABF-S4-2-V2B1-G38-CB-VL-20-A	
	IVPH	Laval nozzle, 2.0 mm with power ejector pulse	970 g	8067144	VABF-S4-2-V2B1-G38-CB-VL-20-AP	
	With high vacuum					
	I	Laval nozzle, 1.4 mm	915 g	8088778	VABF-S4-2-V2B1-G38-CB-VH-14-A	
	IPH	Laval nozzle, 1.4 mm with power ejector pulse	930 g	8088780	VABF-S4-2-V2B1-G38-CB-VH-14-AP	
	III	Laval nozzle, 2.0 mm	920 g	8067140	VABF-S4-2-V2B1-G38-CB-VH-20-A	
	IIIPH	Laval nozzle, 2.0 mm with power ejector pulse	940 g	8067143	VABF-S4-2-V2B1-G38-CB-VH-20-AP	
	V	Laval nozzle, 3.0 mm	955 g	8067142	VABF-S4-2-V2B1-G38-CB-VH-30-A	
	VPH	Laval nozzle, 3.0 mm with power ejector pulse	970 g	8067145	VABF-S4-2-V2B1-G38-CB-VH-30-AP	
	Silencer extension					
		–	Can be attached to enclosed silencer UOM and secured in place.	17.5 g	538437	UOMS-3/8
Blanking plug						
	–	With connecting thread G3/8 (The blanking plug can be used to subsequently convert an existing vacuum generator V...20 to a vacuum generator V...14, or a vacuum generator V...30 to a vacuum generator V...20.)	23 g	8068144	OASC-V1-P	
Pneumatic connection accessories						
A selection of possible fittings, blanking plugs, silencers and other pneumatic accessories can be found in the chapter Accessories → page: 246 or on the website via the individual search terms: Internet → connection technology, silencer, blanking plug						

Datasheet – Valves on individual sub-base

-  Valve width
to ISO 15407-2
 - 18 mm
 - 26 mm
 to ISO 5599-2
 - 42 mm (ISO 1)
 - 52 mm (ISO 2)

-  Flow rate
 - Width 18 mm:
up to 600 l/min
 - Width 26 mm:
up to 1200 l/min
 - Width 42 mm:
up to 1500 l/min
 - Width 52 mm
up to 3400 l/min

-  Voltage
 - 24 V DC
 - 110 V AC

General technical data

Design	Piston spool valve
Sealing principle	Soft
Actuation type	Electrical
Type of actuation	Piloted
Exhaust function, can be throttled	Via individual sub-base
Lubrication	Lifetime lubrication
Type of mounting <ul style="list-style-type: none"> • Valve • Individual sub-base 	Screwed onto sub-base Screwed via through-hole
Mounting position	Any
Manual override	Detenting, non-detenting, concealed

Pneumatic connections – Threaded connection

Width	18 mm	26 mm	42 mm	52 mm	
Pneumatic connection	Via sub-base				
Supply port	1	G1/8	G1/4	G3/8	G1/2
Exhaust port	3/5	G1/8	G1/4	G3/8	G1/2
Working ports	2/4	G1/8	G1/4	G3/8	G1/2
External pilot air supply port	14	M5	G1/8	G1/8	G1/8
Pilot exhaust air port	12	M5	G1/8	G1/8	G1/8

Operating and environmental conditions, individual sub-base

Operating medium	Compressed air to ISO 8573-1:2010 [7:4:4]
Notes on operating/ Pilot medium	Lubricated operation possible (in which case lubricated operation will always be required)
Operating pressure	[bar] -0.9 ... +10 [MPa] -0.09 ... +1
Ambient temperature	[°C] -5 ... +50
Certification	c UL us - Recognized (OL)
CE marking (see declaration of conformity)	To EU Low Voltage Directive (only for 110 V AC coils, not for variants with round plug M12) To EU Explosion Protection Directive (ATEX, EX1E ¹⁾ (for variants with round plug M12 only) To EU RoHS Directive
UKCA marking (see declaration of conformity)	To UK instructions for EMC To UK EX instructions To UK RoHS instructions
ATEX category for gas	II 3G (EX1E ¹⁾)
Type of (ignition) protection for gas	Ex ec IIC T3 Gc X (EX1E ¹⁾)
Explosion ambient temperature	[°C] -5 ... +50 (EX1E ¹⁾)
Explosion protection certification outside the EU	EPL Gc (GB)

1) EX1E certification for installation in a housing

Datasheet – Valves on individual sub-base

Standard nominal flow rate of valve/individual sub-base [l/min] Valve function (with valve code)	Width 18 mm		Width 26 mm	
	Valve	Valve on individual sub-base	Valve	Valve on individual sub-base
	5/2-way, double solenoid (B52)	750	600	1400
5/2-way, double solenoid with dominant signal (D52)	750	600	1400	1200
5/2-way, single solenoid, pneumatic spring (M52-A)	750	600	1400	1200
5/2-way, single solenoid, mechanical spring (M52-M)	750	600	1400	1200
5/3-way, closed (P53C)	700	550	1400 ¹⁾ 700 ²⁾	1200 ¹⁾ 700 ²⁾
5/3-way, exhausted (P53E)	700 ¹⁾ 330 ²⁾	500 ¹⁾ 330 ²⁾	1400 ¹⁾ 700 ²⁾	1200 ¹⁾ 700 ²⁾
5/3-way, pressurised (P53U)	700 ¹⁾ 330 ²⁾	500 ¹⁾ 330 ²⁾	1400 ¹⁾ 700 ²⁾	1200 ¹⁾ 700 ²⁾
5/3-way, exhausted, switching position 14 detenting (P53ED) ³⁾	–	390 ¹⁾ 310 ²⁾	1400 ¹⁾ 700 ²⁾	1200 ¹⁾ 700 ²⁾
5/3-way, exhausted, switching position 12 detenting (P53EP) ³⁾	–	390 ¹⁾ 320 ²⁾	1400 ¹⁾ 700 ²⁾	1200 ¹⁾ 700 ²⁾
5/3-way, port 2 pressurised, 4 exhausted, switching position 14 detenting (P53AD) ³⁾	–	380 ¹⁾ 360 ²⁾	700 ¹⁾ 700 ²⁾	700 ¹⁾ 700 ²⁾
5/3-way, port 4 pressurised, 2 exhausted, switching position 14 detenting (P53BD) ³⁾	–	400	–	900 ¹⁾ 840 ²⁾
2x3/2-way, single solenoid, closed (T32C)	600	500	1250	1100
2x3/2-way, single solenoid, open (T32U)	600	500	1250	1100
2x3/2-way, single solenoid, open/closed (T32H)	600	500	1250	1100
2x3/2-way, single solenoid, closed (T32N)	600	500	1250	1100
2x3/2-way, single solenoid, open (T32F)	600	500	1250	1100
2x3/2-way, single solenoid, open/closed (T32W)	600	500	1250	1100
2x2/2-way, single solenoid, closed (T22C)	700	500	1350	1100
2x2/2-way, single solenoid, closed (T22CV)	700	500	1350	1100

1) Switching position

2) Mid-position

3) The valve functions P53AD, P53BD, P53ED, P53EP are only available in the 24 V DC version. Values only apply to 24 V DC.

Datasheet – Valves on individual sub-base

Standard nominal flow rate of valve/individual sub-base [l/min] Valve function (with valve code)	Width 42 mm		Width 52 mm	
	Valve	Valve on individual sub-base	Valve	Valve on individual sub-base
5/2-way, double solenoid (B52)	2000	1500	4000	3400
5/2-way, double solenoid with dominant signal (D52)	2000	1500	4000	3400
5/2-way, single solenoid, pneumatic spring (M52-A)	2000	1500	4000	3400
5/2-way, single solenoid, mechanical spring (M52-M)	2000	1500	4000	3400
5/3-way, closed (P53C)	1900 ¹⁾ 950 ²⁾	1400 ¹⁾ 800 ²⁾	3600 ¹⁾ 1700 ²⁾	3200 ¹⁾ 1700 ²⁾
5/3-way, exhausted (P53E)	1900 ¹⁾ 950 ²⁾	1400 ¹⁾ 800 ²⁾	3600 ¹⁾ 1700 ²⁾	3200 ¹⁾ 1700 ²⁾
5/3-way, pressurised (P53U)	1900 ¹⁾ 950 ²⁾	1400 ¹⁾ 800 ²⁾	3600 ¹⁾ 1700 ²⁾	3200 ¹⁾ 1700 ²⁾
5/3-way, pressurised 1 to 2, 4 to 5 closed (P53F) ³⁾	1700 ¹⁾ 700 ²⁾	1400 ¹⁾ 700 ²⁾	3000 ¹⁾ 900 ²⁾	2600 ¹⁾ 900 ²⁾
2x3/2-way, single solenoid, closed (T32C)	1600	1200	3000	2600
2x3/2-way, single solenoid, open (T32U)	1600	1200	3000	2600
2x3/2-way, single solenoid, open/closed (T32H)	1600	1200	3000	2600
2x3/2-way, single solenoid, closed (T32N)	1600	1200	3000	2600
2x3/2-way, single solenoid, open (T32F)	1600	1200	3000	2600
2x3/2-way, single solenoid, open/closed (T32W)	1600	1200	3000	2600
2x2/2-way, single solenoid, closed (T22C)	1600	1400	4000	3400
2x2/2-way, single solenoid, closed (T22CV)	1600	1400	–	–

- 1) Switching position
 2) Mid-position
 3) The valve function P53F is only available in the 24 V DC version. Values only apply to 24 V DC.

Electrical data, individual sub-base		
Acceptable current load at 40°C	[A]	2 (1 A per coil)
Degree of protection to EN 60529		IP65, NEMA 4 (for all types of signal transmission when mounted)
Variants with round plug M12		
Operating voltage range	[V DC]	24 ±10% (for variants with round plug M12 VABS-...-R3)
Surge resistance	[kV]	0.8
Pollution degree		3
Duty cycle	ED	100%
Variants with cable connector		
Operating voltage range	[V DC]	24 ±10% (for variants with cable terminal VABS-...-K1/C1, ...-K2)
	[V AC]	110 ±10% (50 ... 60Hz) (for variants with cable and spring-loaded terminal VABS-...-K1/C1, ...-K2)
Surge resistance	[kV]	4
Pollution degree		3
Duty cycle	[ED]	100%



Note

A cable connector is needed to ensure the IP degree of protection and to protect against tensile load, twisting and bending.

Datasheet – Valves on individual sub-base

Materials				
Width	18 mm	26 mm	42 mm	52 mm
Sub-base	Die-cast aluminium			Gravity die-cast aluminium
Valve	Die-cast aluminium, PA			
Seals	FPM, NBR			
Note on materials	RoHS-compliant			
Product weight [g]				
Width	18 mm	26 mm	42 mm	52 mm
Valves				
5/2-way solenoid valve, double solenoid (B52, D52)	172	276	439	732
5/2-way valve, single solenoid (M52A, M52M)	163	293	426	702
5/3-way solenoid valve (P53C, P53E, P53U)	191	320	456	780
5/3-way solenoid valve (P53BD)	172	301	–	–
5/3-way solenoid valve (P53ED, P53EP)	170	291	–	–
5/3-way solenoid valve (P53AD)	172	301	–	–
5/3-way solenoid valve (P53F)	–	–	456	780
2x 3/2-way solenoid valve (T32C, T32U, T32H, T32N, T32F, T32W)	190	335	442	740
2x 2/2-way solenoid valve (T22C, T22CV)	190	335	442	740
Individual connection				
Individual sub-base	192	302	386	815

Datasheet – Valves on individual sub-base

Dimensions

Download CAD data → www.festo.com

Individual sub-base with M12 plug, width 18 mm

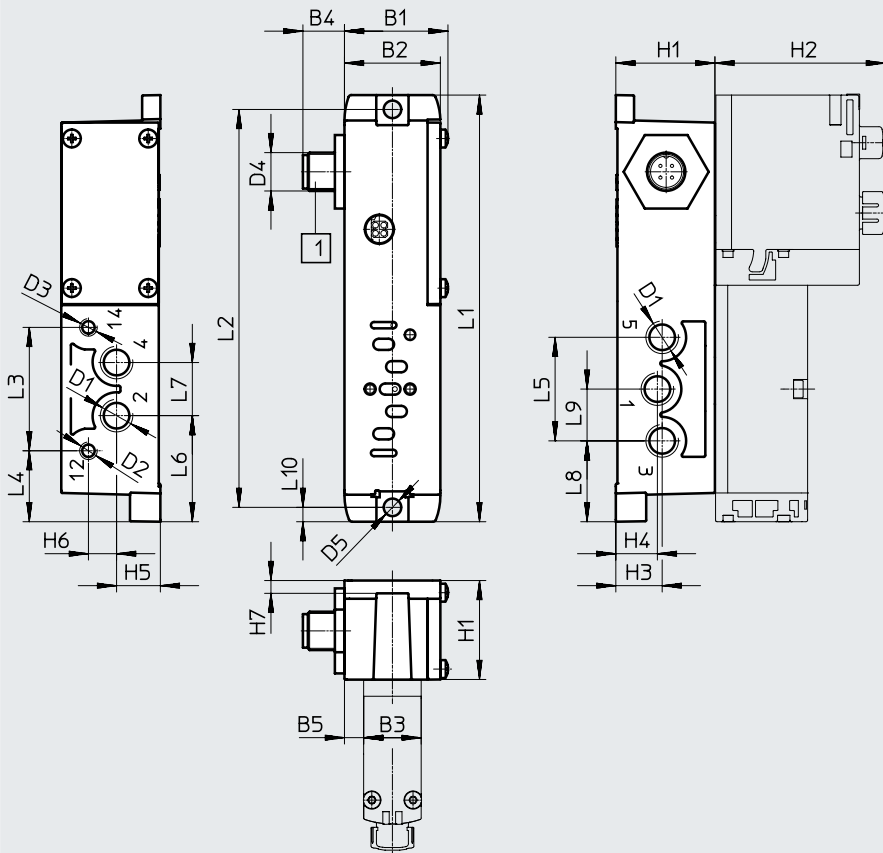

[1] Plug to
EN 61076-2-101

Type	B1	B2	B3	B4	B5	D1	D2	D3	D4	D5∅	H1	H2	H3	H4	H5	H6	H7
VABS-S4-2S-G18-R3 ¹⁾	32.4	30	18	13	6	G1/8	M5	M5	M12x1	5.5	31	53.4	14.5	13	13.7	8.8	4
VABS-S4-2S-G18-B-R3 ²⁾								-									

Type	L1	L2	L3	L4	L5	L6	L7	L8	L9	L10
VABS-S4-2S-G18-R3 ¹⁾	133.5	124.5	38.6	22.2	32.4	33.2	16.6	25.3	16.2	4.5
VABS-S4-2S-G18-B-R3 ²⁾										

- 1) External pilot air supply
- 2) Internal pilot air supply

† Note: this product conforms to ISO 1179-1 and ISO 228-1.

Datasheet – Valves on individual sub-base

Dimensions

Download CAD data → www.festo.com

Individual sub-base with cable terminals, width 18 mm

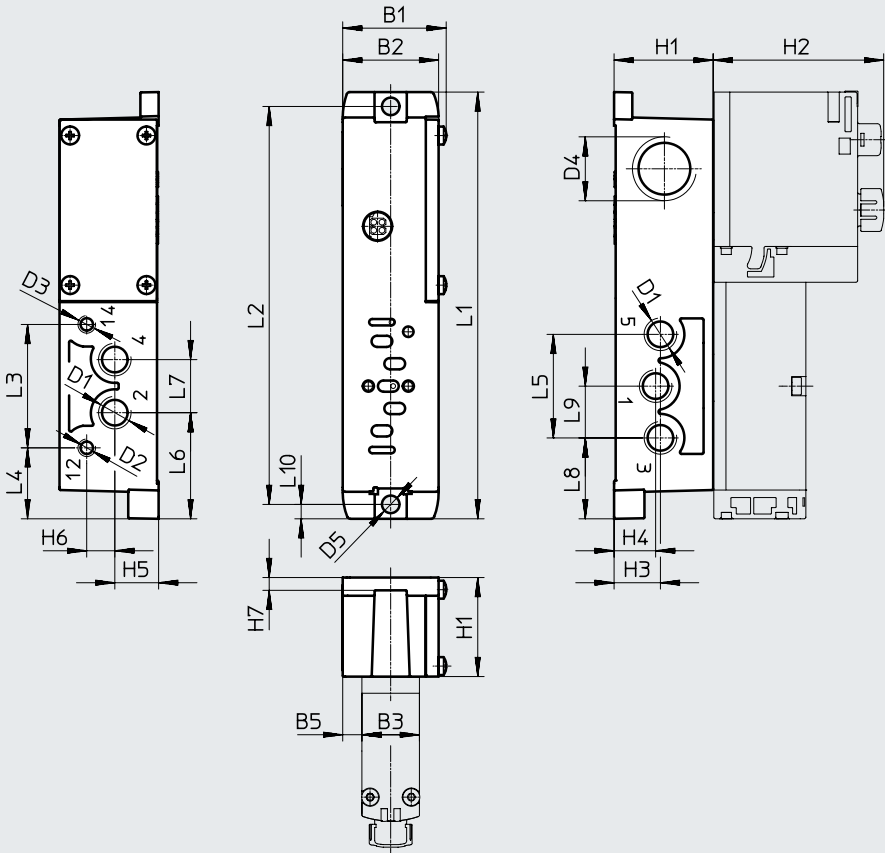

Type	B1	B2	B3	B5	D1	D2	D3	D4	D5∅	H1	H2	H3	H4	H5	H6	H7
VABS-S4-2S-G18-K2 ¹⁾	32.4	30	18	6	G1/8	M5	M5	M20x1.5	5.5	31	53.4	14.5	13	13.7	8.8	4
VABS-S4-2S-G18-B-K2 ²⁾							-									

Type	L1	L2	L3	L4	L5	L6	L7	L8	L9	L10
VABS-S4-2S-G18-K2 ¹⁾	133.5	124.5	38.6	22.2	32.4	33.2	16.6	25.3	16.2	4.5
VABS-S4-2S-G18-B-K2 ²⁾										

1) External pilot air supply

2) Internal pilot air supply

† Note: this product conforms to ISO 1179-1 and ISO 228-1.

Datasheet – Valves on individual sub-base

Dimensions

Download CAD data → www.festo.com

Individual sub-base with M12 plug, width 26 mm

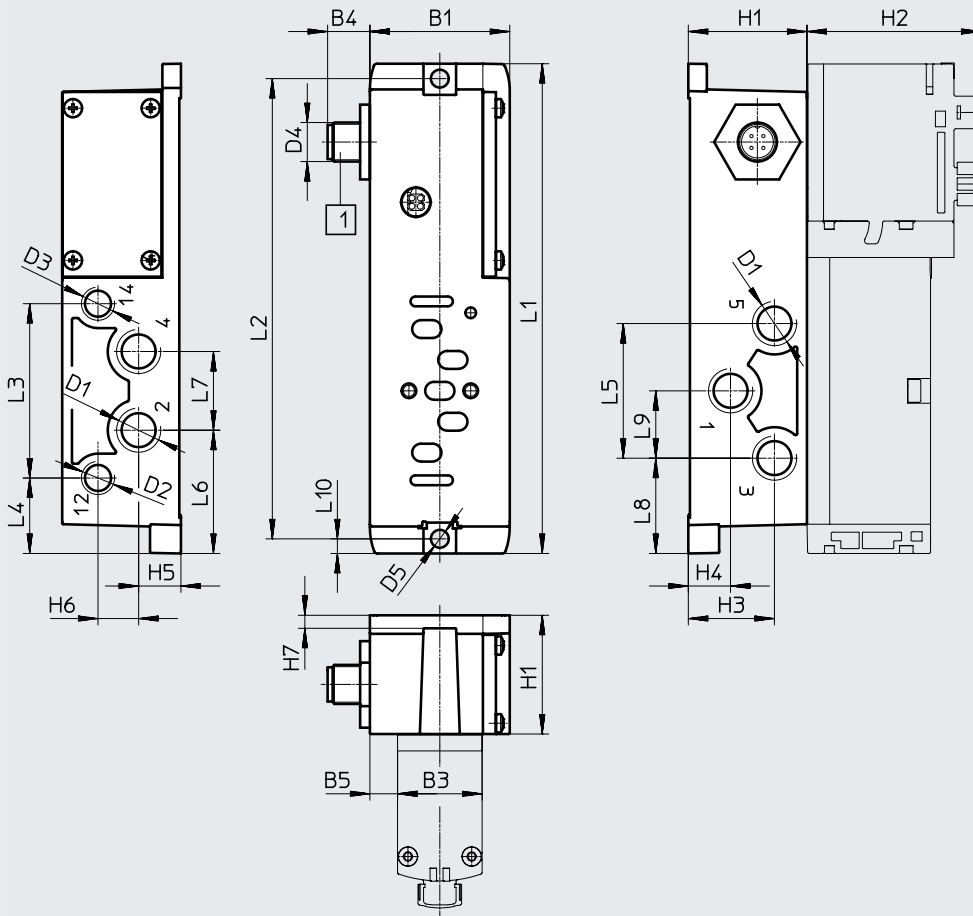

[1] Plug to
EN 61076-2-101

Type	B1	B3	B4	B5	D1	D2	D3	D4	D5 ø	H1	H2	H3	H4	H5	H6	H7
VABS-S4-1S-G14-R3 ¹⁾	43	26	13	8.5	G1/4	G1/8	G1/8	M12x1	5.5	36.5	53.5	26.5	13	13	12.5	4
VABS-S4-1S-G14-B-R3 ²⁾							-									

Type	L1	L2	L3	L4	L5	L6	L7	L8	L9	L10
VABS-S4-1S-G14-R3 ¹⁾	150.6	141.5	53.6	23.2	41.4	37.9	24.2	29.3	20.7	4.5
VABS-S4-1S-G14-B-R3 ²⁾										

- 1) External pilot air supply
- 2) Internal pilot air supply

† Note: this product conforms to ISO 1179-1 and ISO 228-1.

Datasheet – Valves on individual sub-base

Dimensions

Individual sub-base with cable terminals, width 26 mm

Download CAD data → www.festo.com

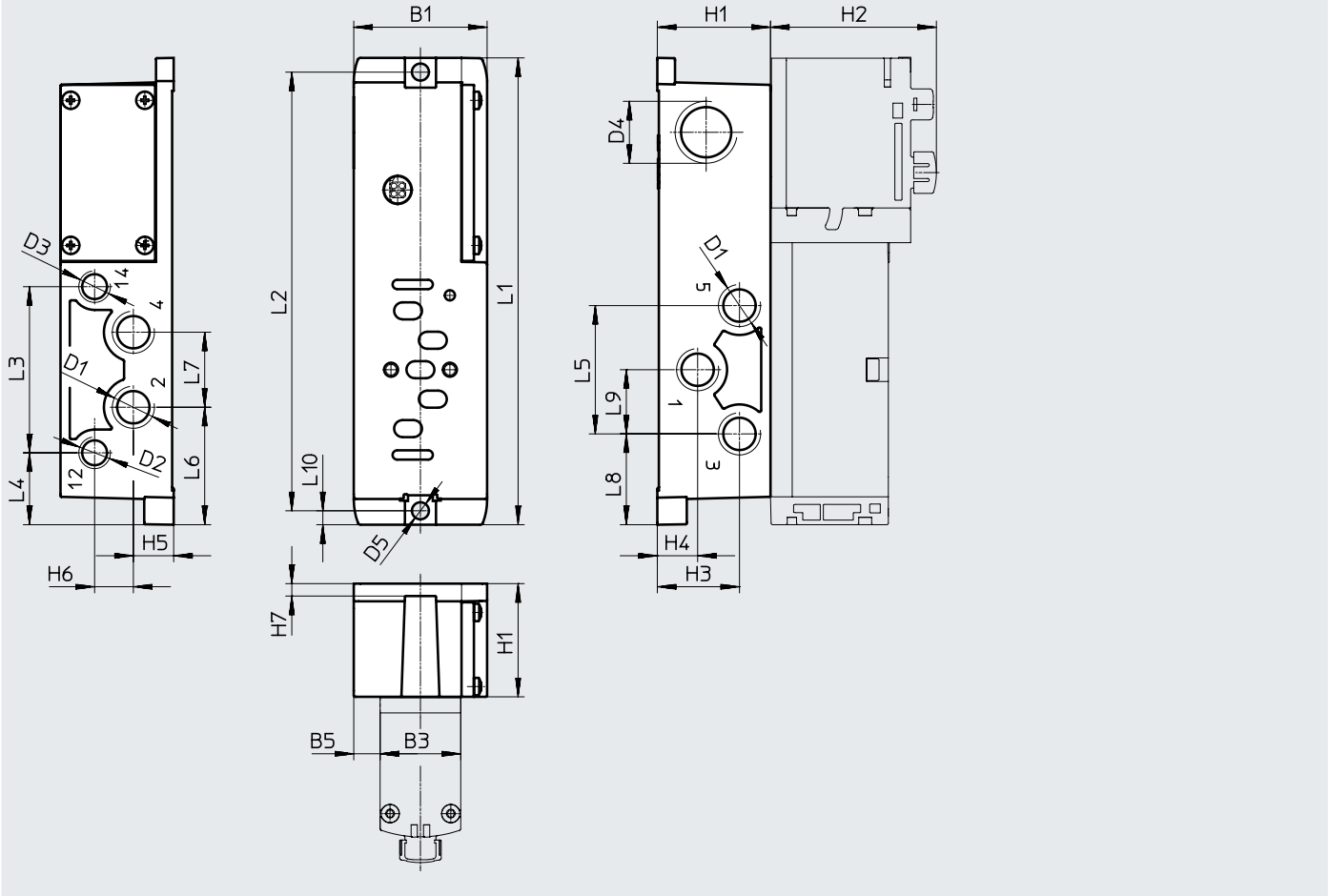

Type	B1	B3	B5	D1	D2	D3	D4	D5 ø	H1	H2	H3	H4	H5	H6	H7
VABS-S4-1S-G14-K2 ¹⁾	43	26	8.5	G1/4	G1/8	G1/8	M20x1.5	5.5	36.5	53.5	26.5	13	13	12.5	4
VABS-S4-1S-G14-B-K2 ²⁾						-									

Type	L1	L2	L3	L4	L5	L6	L7	L8	L9	L10
VABS-S4-1S-G14-K2 ¹⁾	150.6	141.5	53.6	23.2	41.4	37.9	24.2	29.3	20.7	4.5
VABS-S4-1S-G14-B-K2 ²⁾										

1) External pilot air supply
 2) Internal pilot air supply

‡ Note: this product conforms to ISO 1179-1 and ISO 228-1.

Datasheet – Valves on individual sub-base

Dimensions

Download CAD data → www.festo.com

Individual sub-base with M12 plug, width 42 mm

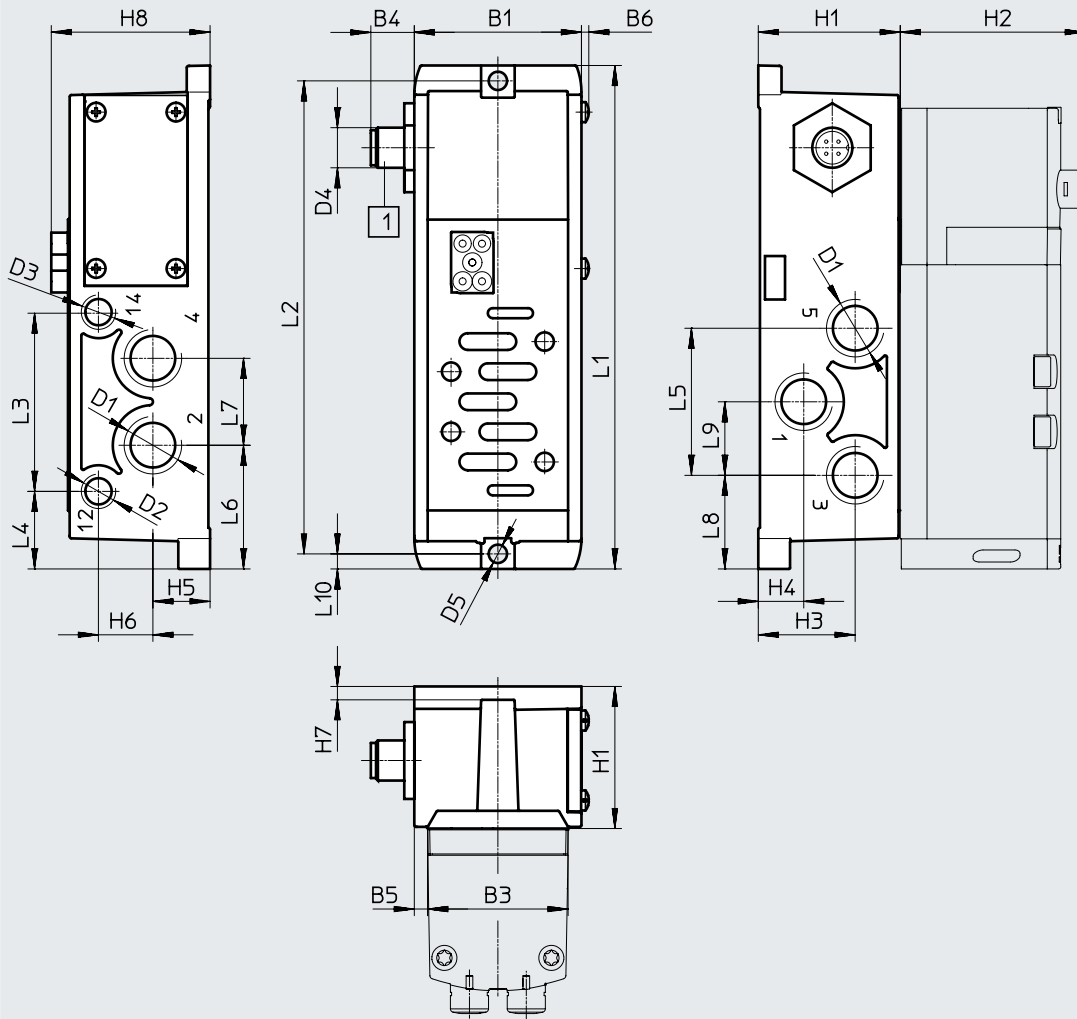

[1] Plug to EN 61076-2-101

Type	B1	B3	B4	B5	B6	D1	D2	D3	D4	D5 \varnothing	H1	H2	H3	H4	H5	H6	H7	H8
VABS-S2-1S-G38-R3 ¹⁾	50	42	13	4	2.2	G3/8	G1/8	G1/8	M20x1.5	5.5	42.5	55.3	29	13.6	17.1	16.3	4	47.5
VABS-S2-1S-G38-B-R3 ²⁾								-										

Type	L1	L2	L3	L4	L5	L6	L7	L8	L9	L10
VABS-S2-1S-G38-R3 ¹⁾	150.6	141.5	53.6	23.2	44	37	26	28	22	4.5
VABS-S2-1S-G38-B-R3 ²⁾										

- 1) External pilot air supply
- 2) Internal pilot air supply

† Note: this product conforms to ISO 1179-1 and ISO 228-1.

Datasheet – Valves on individual sub-base

Dimensions

Download CAD data → www.festo.com

Individual sub-base with spring-loaded terminal or for assembly by the user, width 42 mm

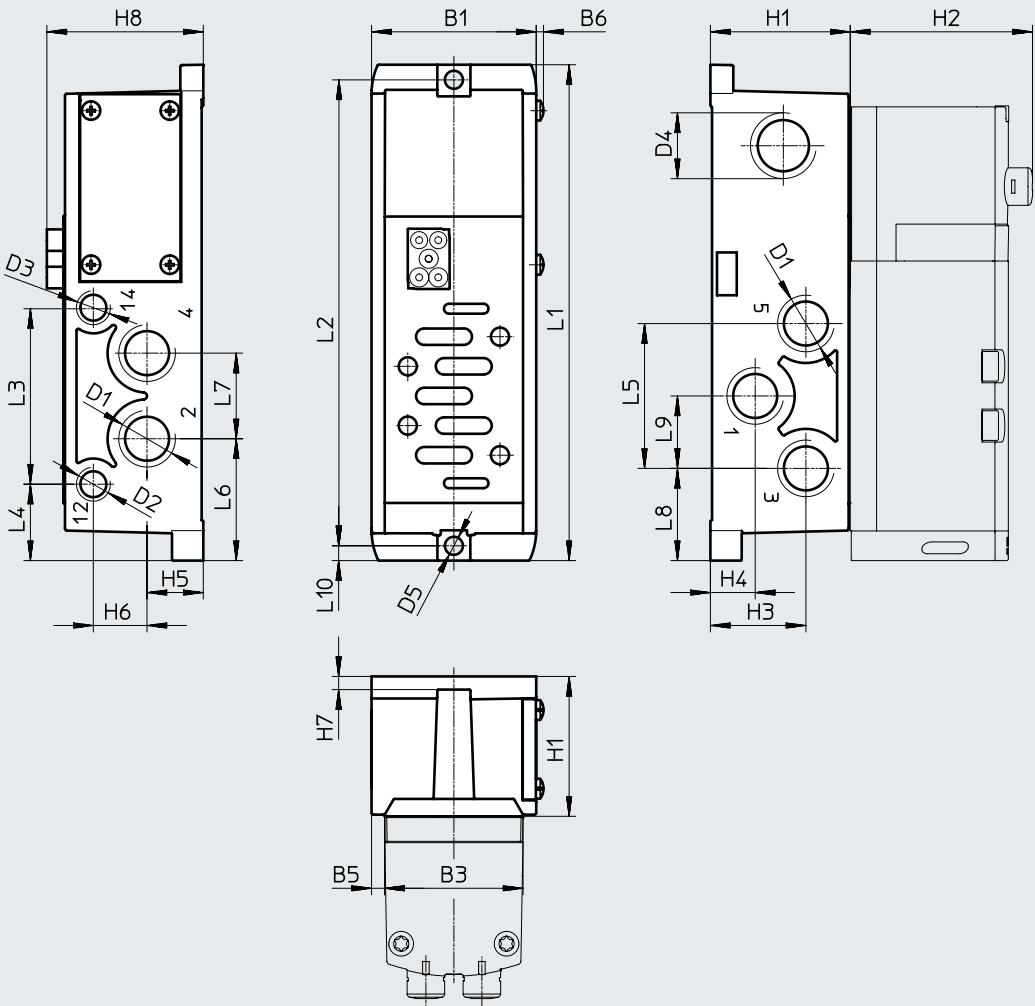

Type	B1	B3	B5	B6	D1	D2	D3	D4	D5 ø	H1	H2	H3	H4	H5	H6	H7	H8
VABS-S2-1S-G38-K1 ¹⁾	50	42	4	2.2	G3/8	G1/8	G1/8	M20x1.5	5.5	42.5	55.3	29	13.6	17.1	16.3	4	47.5
VABS-S2-1S-G38-C1 ¹⁾							-										
VABS-S2-1S-G38-B-K1 ²⁾							-										
VABS-S2-1S-G38-B-C1 ²⁾							-										

Type	L1	L2	L3	L4	L5	L6	L7	L8	L9	L10
VABS-S2-1S-G38-K1 ¹⁾	150.6	141.5	53.6	23.2	44	37	26	28	22	4.5
VABS-S2-1S-G38-C1 ¹⁾										
VABS-S2-1S-G38-B-K1 ²⁾										
VABS-S2-1S-G38-B-C1 ²⁾										

1) External pilot air supply
 2) Internal pilot air supply
 † Note: this product conforms to ISO 1179-1 and ISO 228-1.

Note
 Electrical connection

- VABS-...-K1: open end
- VABS-...-C1: spring-loaded terminal

Datasheet – Valves on individual sub-base

Dimensions

Download CAD data → www.festo.com

Individual sub-base with M12 plug, width 52 mm

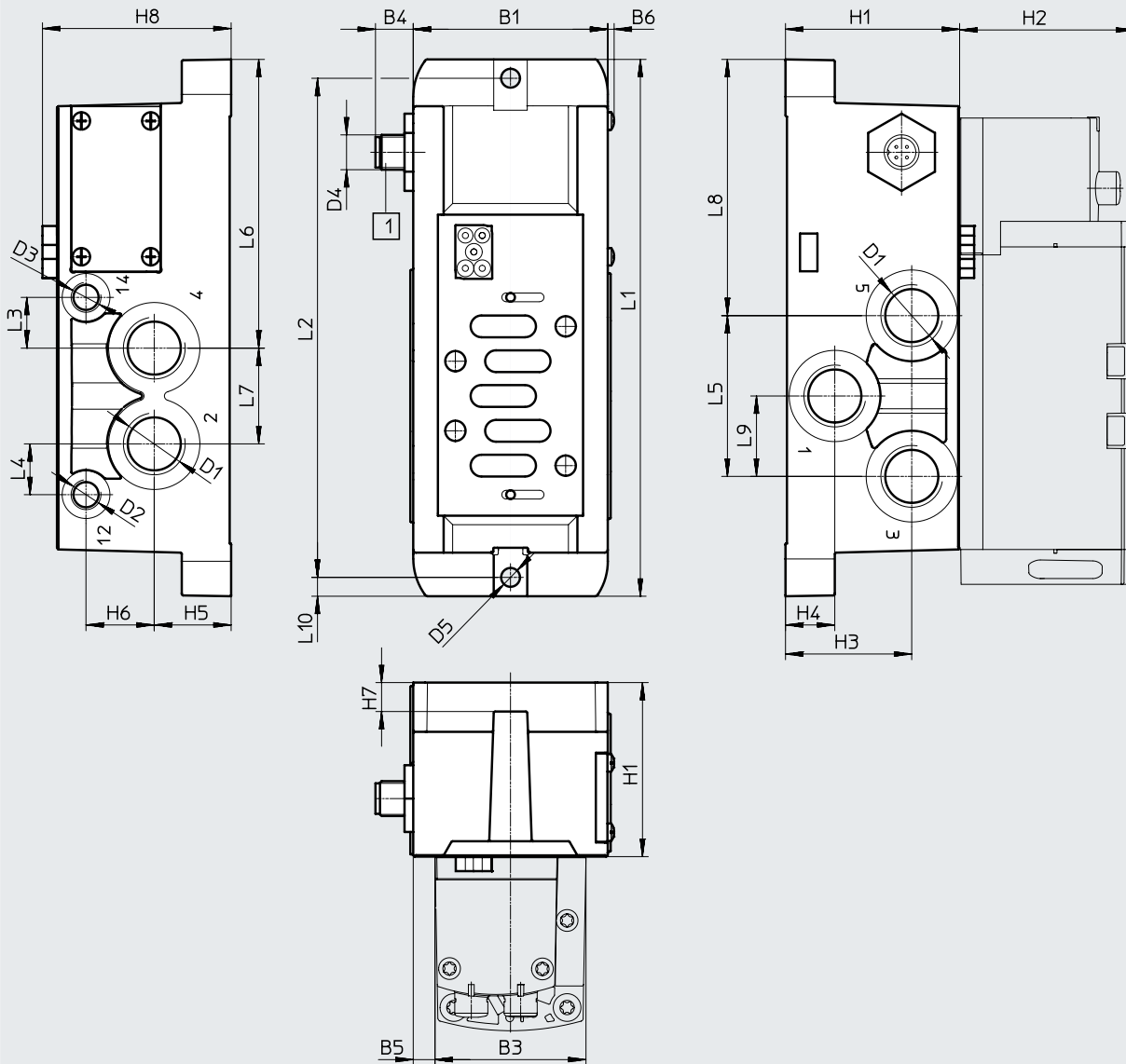

[1] Plug to
EN 61076-2-101

Type	B1	B3	B4	B5	B6	D1	D2	D3	D4	D5 ø	H1	H2	H3	H4	H5	H6	H7	H8
VABS-S2-2S-G12-R3 ¹⁾	67	52	13	7.5	2.2	G1/2	G1/8	G1/8	M12x1	6.5	60	60	43.5	17	26.5	23.5	10	65
VABS-S2-2S-G12-B-R3 ²⁾								-										

Type	L1	L2	L3	L4	L5	L6	L7	L8	L9	L10
VABS-S2-2S-G12-R3 ¹⁾	185	172	17.5	17.5	55.4	99.5	33	88.3	27.7	6.5
VABS-S2-2S-G12-B-R3 ²⁾										

- 1) External pilot air supply
- 2) Internal pilot air supply

† Note: this product conforms to ISO 1179-1 and ISO 228-1.

Datasheet – Valves on individual sub-base

Dimensions

Download CAD data → www.festo.com

Individual sub-base with spring-loaded terminal or for assembly by the user, width 52 mm

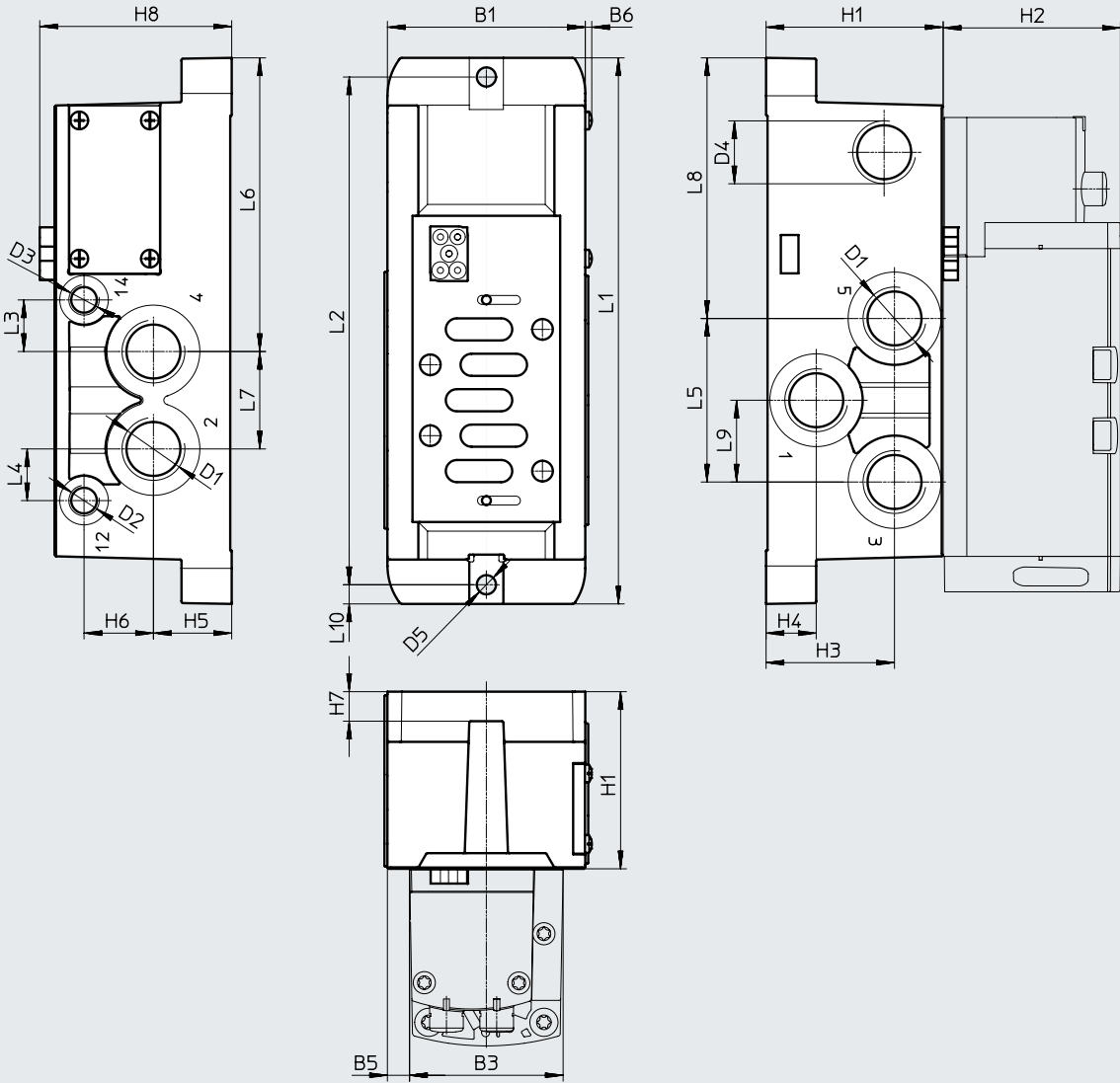

Type	B1	B3	B5	B6	D1	D2	D3	D4	D5 ø	H1	H2	H3	H4	H5	H6	H7	H8
VABS-S2-2S-G12-K1 ¹⁾	67	52	7.5	2.2	G1/2	G1/8	G1/8	M20x1.5	6.5	60	60	43.5	17	26.5	23.5	10	65
VABS-S2-2S-G12-C1 ¹⁾							-										
VABS-S2-2S-G12-B-K1 ²⁾							-										
VABS-S2-2S-G12-B-C1 ²⁾							-										

Type	L1	L2	L3	L4	L5	L6	L7	L8	L9	L10
VABS-S2-2S-G12-K1 ¹⁾	185	172	17.5	17.5	55.4	99.5	33	88.3	27.7	6.5
VABS-S2-2S-G12-C1 ¹⁾										
VABS-S2-2S-G12-B-K1 ²⁾										
VABS-S2-2S-G12-B-C1 ²⁾										

1) External pilot air supply
 2) Internal pilot air supply

† Note: this product conforms to ISO 1179-1 and ISO 228-1.

- Note**
 Electrical connection
- VABS-...-K1: open end
 - VABS-...-C1: spring-loaded terminal

Accessories – Individual connection

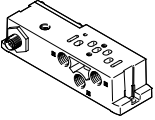
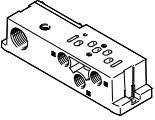
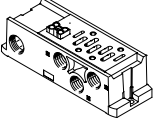
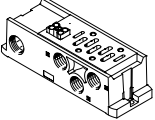
Ordering data	Description	Width	Part no.	Type	
Individual sub-base, electrical connection with plug M12 (without CE marking)					
	Threaded connection, internal pilot air supply	Connections G1/8	18 mm	541070	VABS-S4-2S-G18-B-R3
				8033156	VABS-S4-2S-G18-B-R3-EX1E
		Connections G1/4	26 mm	541069	VABS-S4-1S-G14-B-R3
				8033158	VABS-S4-1S-G14-B-R3-EX1E
		Connections G3/8	42 mm	546104	VABS-S2-1S-G38-B-R3
				8033160	VABS-S2-1S-G38-B-R3-EX1E
	Threaded connection, external pilot air supply	Connections G1/8	18 mm	541064	VABS-S4-2S-G18-R3
				8033155	VABS-S4-2S-G18-R3-EX1E
		Connections G1/4	26 mm	541063	VABS-S4-1S-G14-R3
				8033157	VABS-S4-1S-G14-R3-EX1E
		Connections G3/8	42 mm	546101	VABS-S2-1S-G38-R3
				8033159	VABS-S2-1S-G38-R3-EX1E
		Connections G1/2	52 mm	555645	VABS-S2-2S-G12-B-R3
				8033162	VABS-S2-2S-G12-B-R3-EX1E
Individual sub-base, electrical connection via cable terminals					
	Threaded connection, internal pilot air supply	Connections G1/8	18 mm	541067	VABS-S4-2S-G18-B-K2
		Connections G1/4	26 mm	541065	VABS-S4-1S-G14-B-K2
	Threaded connection, external pilot air supply	Connections G1/8	18 mm	539723	VABS-S4-2S-G18-K2
		Connections G1/4	26 mm	539725	VABS-S4-1S-G14-K2
Individual sub-base, electrical connection via spring-loaded terminal					
	Threaded connection, internal pilot air supply	Connections G3/8	42 mm	546762	VABS-S2-1S-G38-B-C1
		Connections G1/2	52 mm	555643	VABS-S2-2S-G12-B-C1
	Threaded connection, external pilot air supply	Connections G3/8	42 mm	546760	VABS-S2-1S-G38-C1
		Connections G1/2	52 mm	555638	VABS-S2-2S-G12-C1
Individual sub-base, electrical connection via cable (open end)					
	Threaded connection, internal pilot air supply	Connections G3/8	42 mm	546102	VABS-S2-1S-G38-B-K1
		Connections G1/2	52 mm	555641	VABS-S2-2S-G12-B-K1
	Threaded connection, external pilot air supply	Connections G3/8	42 mm	546099	VABS-S2-1S-G38-K1
		Connections G1/2	52 mm	555636	VABS-S2-2S-G12-K1

Accessories – Individual connection

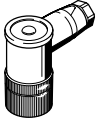
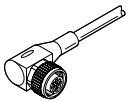
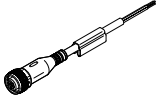
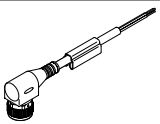
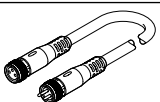
Ordering data	Description	Part no.	Type
Plug socket for the electrical connection of individual valves			
	Angled socket, 1xM12, 4-pin, type A, screw terminal	12956	SIE-WD-TR
Connecting cable for electrical connection of individual valves, 6-way or 10-way			
	<ul style="list-style-type: none"> • Angled socket, 1xM12, 4-pin • Open end, 4-core 	5 m	164258 SIM-M12-4WD-5-PU
	<ul style="list-style-type: none"> • Straight socket, 1xM12, 5-pin • Open end, 4-core 	5 m	541328 NEBU-M12G5-K-5-LE4
	<ul style="list-style-type: none"> • Angled socket, 1xM12, 5-pin • Open end, 4-core 	5 m	541329 NEBU-M12W5-K-5-LE4
	Modular system for a choice of connecting cables	–	– NEBU-... → Internet: nebu
Pneumatic connection accessories			
<p>A selection of possible fittings, blanking plugs, silencers and other pneumatic accessories can be found in the chapter Accessories → page: 246 or on the website via the individual search terms:</p> <p>Internet → connection technology, silencer, blanking plug</p>			

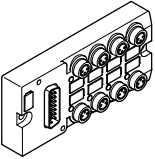
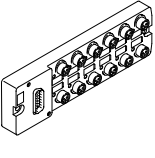
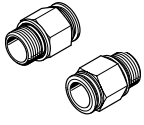
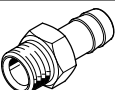

Accessories

Ordering data		Code	Description	Part no.	Type	PU ¹⁾	
Multi-pin plug distributor							
	-		15-pin Sub-D socket/8x 3-pin M8 plugs	8 I/Os	177669	MPV-E/A08-M8	1
	-		15-pin Sub-D socket/12x 3-pin M8 plugs	12 I/Os	177670	MPV-E/A12-M8	1
Push-in fitting with connecting thread							
	-	G1/8 for	Tubing O.D. 6 mm	Plastic releasing ring	186096	QS-G1/8-6	10
	E			Metal releasing ring	558662	NPQM-D-G18-Q6-P10	10
	-	G1/8 for	Tubing O.D. 8 mm	Plastic releasing ring	186098	QS-G1/8-8	10
	E			Metal releasing ring	558663	NPQM-D-G18-Q8-P10	10
	-	G1/8 for	Tubing O.D. 10 mm	Plastic releasing ring	190643	QS-G1/8-10	10
	E			Metal releasing ring	558664	NPQM-D-G18-Q10-P10	10
	-	G1/4 for	Tubing O.D. 8 mm	Plastic releasing ring	186099	QS-G1/4-8	10
	E			Metal releasing ring	558665	NPQM-D-G14-Q8-P10	10
	-	G1/4 for	Tubing O.D. 10 mm	Plastic releasing ring	186101	QS-G1/4-10	10
	E			Metal releasing ring	558666	NPQM-D-G14-Q10-P10	10
	-	G1/4 for	Tubing O.D. 12 mm	Plastic releasing ring	186350	QS-G1/4-12	10
	E			Metal releasing ring	558667	NPQM-D-G14-Q12-P10	10
	-	G3/8 for	Tubing O.D. 10 mm	Plastic releasing ring	186102	QS-G3/8-10	10
	E			Metal releasing ring	558669	NPQM-D-G38-Q10-P10	10
	-	G3/8 for	Tubing O.D. 12 mm	Plastic releasing ring	186114	QS-G3/8-12-I	10
	E			Metal releasing ring	558670	NPQM-D-G38-Q12-P10	10
-	G1/2 for	Tubing O.D. 12 mm	Plastic releasing ring	186104	QS-G1/2-12	1	
E			Metal releasing ring	558672	NPQM-D-G12-Q12-P10	10	
-	G1/2 for	Tubing O.D. 14 mm	Plastic releasing ring	570451	NPQM-D-G12-Q14-P10	1	
E			Metal releasing ring	570451	NPQM-D-G12-Q14-P10	1	
-	G1/2 for	Tubing O.D. 16 mm	Plastic releasing ring	186105	QS-G1/2-16	1	
E			Metal releasing ring	570451	NPQM-D-G12-Q14-P10	1	
Barbed hose fitting/push-in fitting							
	-	For right end plate	G3/4	8040613	QS-G3/4-22	1	
	-		R1	572260	N-1-P-19	1	
	-	For adapter plate	R1	572260	N-1-P-19	1	

1) Packaging unit

 **Note**
 Metal push-in fittings type NPQM-... should be selected when the highest protection is required for electrical and electronic components (anti-static requirements).

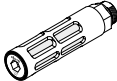
Accessories

Ordering data		Code	Description	Part no.	Type	PU ¹⁾
Silencer						
	U	Standard design, connecting thread	G1/8	2307	U-1/8	1
			G1/4	2316	U-1/4	1
			G3/8	6843	U-3/8-B	1
			G1/2	6844	U-1/2-B	1
			G3/4	6845	U-3/4-B	1
			G1	151990	U-1-B	1
	A	Sintered design, connecting thread	G1/8	1205860	AMTE-M-LH-G18	20
			G1/4	1205861	AMTE-M-LH-G14	20
			G3/8	1205862	AMTE-M-LH-G38	10
			G1/2	1205863	AMTE-M-LH-G12	10
			G3/4	1205864	AMTE-M-LH-G34	10
			G1	1205865	AMTE-M-LH-G1	10
Blanking plug						
	-	Connecting thread	M5	3843	B-M5	10
			G1/8	3568	B-1/8	10
			G1/4	3569	B-1/4	10
			G1/2	3571	B-1/2	10
			G3/4	3572	B-3/4	1
			G1	5763	B-1	1
Other pneumatic connection accessories						
A selection of possible fittings, blanking plugs and silencers can be found on the website via the individual search terms: Internet → connection technology, silencer, blanking plug						

1) Packaging unit