

Plastic tubing PUN, PUN-DUO

FESTO



Characteristics

At a glance

Maximum flexibility in standard applications and a very wide range of combinations.

- Polyurethane
- High resistance to stress cracks
- Suitable for energy chains
- Also available as DUO plastic tubing
- Operating medium: compressed air, vacuum

Ordering data - modular system

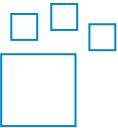

Configurable product

This product and all its product options can be ordered online via the configurator.

Diagrams

[Further information → pun](#)



The diagrams shown in this document are also available online. These can be used to display precise values.

Pipe/tubing O.D. x wall thickness

For standard O.D. tubing, the outside diameter of the tube and the wall thickness are given as the tube size.

Tubing type

[] Standard

Consists of a single tube

[DUO] DUO pneumatic tubing

Two pieces of tubing are welded together to form a pair. During installation, the tubing pair is cut to the required length at both ends.

Packaging unit [m]

- Standard: 50 m
- In some cases, available in longer lengths on a reel.

Type code

001	Series
PUN	Plastic tubing, polyurethane

002	Pipe/tubing O.D. x wall thickness
3x0,5	3x0.5 mm
4x0,75	4x0.75 mm
6x1	6x1 mm
8x1,25	8x1.25 mm
10x1,5	10x1.5 mm
12x2	12x2 mm
14x2	14x2 mm
16x2,5	16x2.5 mm

003	Tubing type
	Standard
DUO	DUO pneumatic tubing

004	Colour
SW	Black
BL	Blue
SI	Silver
RT	Red
GN	Green
GE	Yellow
BS	Blue/black

005	Packaging unit [m]
	Standard
100	100 m
200	200 m
300	300 m
400	400 m
500	500 m

Datasheet

Operating and environmental conditions

Outside diameter	3 mm	4 mm	6 mm	8 mm	10 mm	12 mm	14 mm	16 mm
Inside diameter	2.1 mm	2.6 mm	4 mm	5.7 mm	7 mm	8 mm	9.8 mm	11 mm
Pneumatic connection	For push-in connector outside diameter of 3 mm For barbed fitting inside diameter of 2 mm	For push-in connector O.D. 4 mm For barbed fitting I.D. 3 mm with union nut For barbed fitting I.D. 3 mm	For push-in connector O.D. 6 mm For barbed fitting I.D. 4 mm with union nut For barbed fitting I.D. 4 mm	For push-in connector O.D. 8 mm For barbed fitting inside diameter of 6 mm with union nut For barbed fitting inside diameter of 6 mm	For push-in connector O.D. 10 mm	For push-in connector outside diameter of 12 mm	For push-in connector outer diameter of 14 mm	For push-in connector O.D. 16 mm
Flow-relevant bending radius	12 mm	17 mm	26.5 mm	37 mm	54 mm	62 mm	84 mm	88 mm
Min. bending radius	9 mm	8 mm	16 mm	24 mm	28 mm	33 mm	45 mm	
Temperature-dependent operating pressure	-0.095 ... 1 MPa							
Temperature-dependent operating pressure	-0.95 ... 10 bar							
Temperature-dependent operating pressure	-13.775 ... 145 psi							
Operating medium	Compressed air to ISO 8573-1:2010 [7:-:]							
Ambient temperature	-35 ... 60°C							
Fire test material	UL94 HB							
Approval	German Technical Control Board (TÜV)							
Certificate issuing authority	B 013277 0506 00							
Tubing characteristics	Suitable for energy chains							

Operating pressure p as a function of temperature t

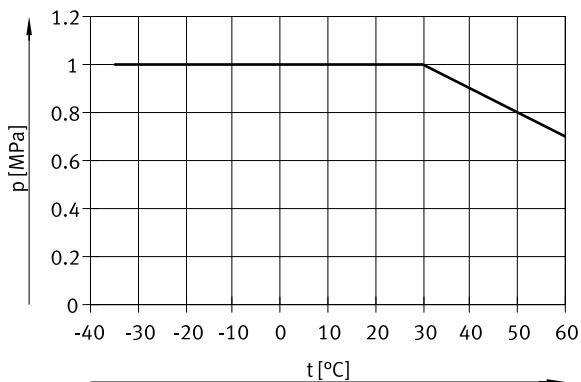

Materials

Shore hardness	D 52 +/-3
Material tubing	TPE-U(PU)
Note on materials	RoHS-compliant
LABS (PWIS) conformity	VDMA24364-B2-L
Instructions on use	TPE-U Ester based, The plastic tubing can only be installed in contact with cables if the sheathing is free of phosphoric acid esters. Otherwise the plastic tubing may get damaged.

Dimensions

Dimensions – Reel

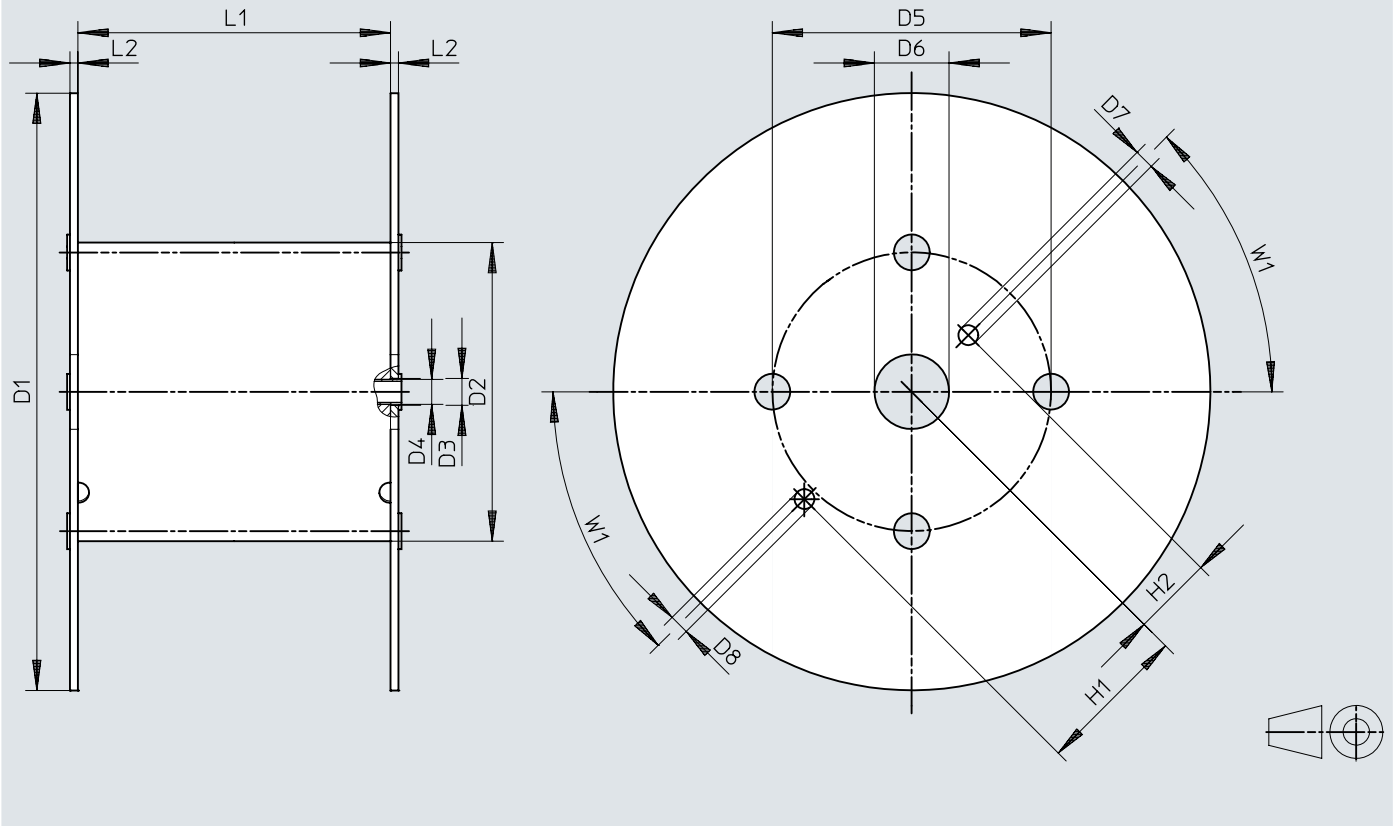
Download CAD data → www.festo.com

	D1 ∅	D2 ∅	D3 ∅	D4 ∅	D5 ∅	D6 ∅	D7 ∅	D8 ∅	H1	H2	L1	L2	W1
PUN-3x0,5-...-500	545	246	21	20	216	75	20	20	152,5	80,5	128	8	45°
PUN-4x0,75-...-500	545	246	21	20	216	75	20	20	152,5	80,5	128	8	45°
PUN-6x1-...-500	600	310	21	20	280	75	20	20	152,5	80,5	114	8	45°
PUN-8x1,25-...-400	545	310	21	20	280	75	20	20	152,5	80,5	254	8	45°
PUN-10x1,5-...-300	600	310	21	20	280	75	20	20	152,5	80,5	254	8	45°
PUN-12x2-...-200	600	310	21	20	280	75	20	20	152,5	80,5	254	8	45°
PUN-16x2,5-...-100	545	310	21	20	280	75	20	20	152,5	80,5	254	8	45°

Ordering data

Ordering data PUN						
	Outside diameter	Packaging unit [m] ¹⁾	Product weight according to length	Colour	Part no.	Type
	3 mm	Standard	0.004 kg/m	Blue	159660	PUN-3X0,5-BL
				Yellow	178416	PUN-3X0,5-GE
				Green	178423	PUN-3X0,5-GN
				Red	178409	PUN-3X0,5-RT
				Black	159661	PUN-3X0,5-SW
				Silver	152583	PUN-3X0,5-SI
				Blue	525745	PUN-3X0,5-BL-500
				Black	553936	PUN-3X0,5-SW-500
	500 m			Silver	525738	PUN-3X0,5-SI-500
	4 mm	Standard	0.009 kg/m	Blue	159662	PUN-4X0,75-BL
				Yellow	178417	PUN-4X0,75-GE
				Green	178424	PUN-4X0,75-GN
				Red	178410	PUN-4X0,75-RT
				Black	159663	PUN-4X0,75-SW
				Silver	152584	PUN-4X0,75-SI
				Blue	525746	PUN-4X0,75-BL-500
				Black	553937	PUN-4X0,75-SW-500
	500 m			Silver	525739	PUN-4X0,75-SI-500
	6 mm	Standard	0.019 kg/m	Blue	159664	PUN-6X1-BL
				Yellow	178418	PUN-6X1-GE
				Green	178425	PUN-6X1-GN
				Red	178411	PUN-6X1-RT
				Black	159665	PUN-6X1-SW
				Silver	152586	PUN-6X1-SI
				Blue	525747	PUN-6X1-BL-500
				Black	553938	PUN-6X1-SW-500
	500 m			Silver	525740	PUN-6X1-SI-500
	8 mm	Standard	0.03 kg/m	Blue	159666	PUN-8X1,25-BL
				Yellow	178419	PUN-8X1,25-GE
				Green	178426	PUN-8X1,25-GN
				Red	178412	PUN-8X1,25-RT
				Black	159667	PUN-8X1,25-SW
				Silver	152587	PUN-8X1,25-SI
				Blue	525748	PUN-8X1,25-BL-400
				Black	553939	PUN-8X1,25-SW-400
	400 m			Silver	525741	PUN-8X1,25-SI-400
10 mm	Standard	0.049 kg/m	Blue	159668	PUN-10X1,5-BL	
			Yellow	178420	PUN-10X1,5-GE	
			Green	178427	PUN-10X1,5-GN	
			Red	178413	PUN-10X1,5-RT	
			Black	159669	PUN-10X1,5-SW	
			Silver	152588	PUN-10X1,5-SI	
			Blue	525749	PUN-10X1,5-BL-300	
			Black	553940	PUN-10X1,5-SW-300	
300 m			Silver	525742	PUN-10X1,5-SI-300	
12 mm	Standard	0.077 kg/m	Blue	159670	PUN-12X2-BL	
			Yellow	178421	PUN-12X2-GE	
			Green	178428	PUN-12X2-GN	
			Red	178414	PUN-12X2-RT	
			Black	159671	PUN-12X2-SW	
			Silver	152589	PUN-12X2-SI	
200 m			Blue	525750	PUN-12X2-BL-200	

Ordering data

Ordering data PUN						
	Outside diameter	Packaging unit [m] ¹⁾	Product weight according to length	Colour	Part no.	Type
	12 mm	200 m	0.077 kg/m	Black	553941	PUN-12X2-SW-200
				Silver	525743	PUN-12X2-SI-200
	14 mm	Standard	0.095 kg/m	Blue	570390	PUN-14X2-BL
				Black	570391	PUN-14X2-SW
				Silver	570389	PUN-14X2-SI
	16 mm	Standard	0.129 kg/m	Blue	159672	PUN-16X2,5-BL
				Yellow	178422	PUN-16X2,5-GE
				Green	178429	PUN-16X2,5-GN
				Red	178415	PUN-16X2,5-RT
				Black	159673	PUN-16X2,5-SW
				Silver	152590	PUN-16X2,5-SI
				Blue	525751	PUN-16X2,5-BL-100
				Black	553942	PUN-16X2,5-SW-100
		100 m		Silver	525744	PUN-16X2,5-SI-100

1) Standard: 50 m

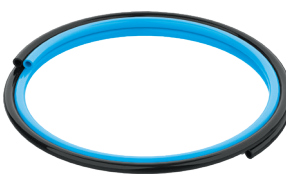
Ordering data PUN-DUO						
	Outside diameter	Packaging unit [m] ¹⁾	Product weight according to length	Colour	Part no.	Type
	4 mm	Standard	0.017 kg/m	Blue/black	197396	PUN-H-4X0,75-DUO
			0.018 kg/m		159674	PUN-4X0,75-DUO-BS
				Silver	152822	PUN-4X0,75-DUO-SI
	6 mm	Standard	0.037 kg/m	Blue/black	197397	PUN-H-6X1-DUO
			0.038 kg/m		159675	PUN-6X1-DUO-BS
				Silver	152823	PUN-6X1-DUO-SI
	8 mm	Standard	0.057 kg/m	Blue/black	197398	PUN-H-8X1,25-DUO
			0.06 kg/m		159676	PUN-8X1,25-DUO-BS
				Silver	152824	PUN-8X1,25-DUO-SI
	10 mm	Standard	0.093 kg/m	Blue/black	197399	PUN-H-10X1,5-DUO
			0.098 kg/m		159677	PUN-10X1,5-DUO-BS
				Silver	152825	PUN-10X1,5-DUO-SI

1) Standard: 50 m

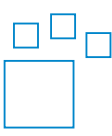
Ordering data – Modular product system			
	Short type code	Part no.	Type
	PUN, PUN-CM, PUN-H, PUN-V0, PUN-V0-C	553573	PUN