

Servo drive CMMT-AS

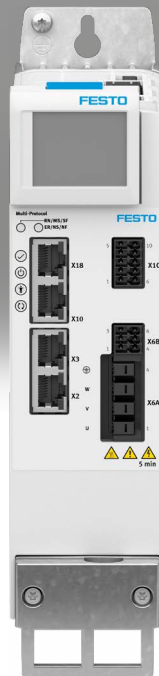

Festo Core Range
Solves the majority of your automation tasks

Worldwide: Quickest delivery – wherever, whenever
Simply good: Expected high Festo quality
Fast: Easy and fast to select

With the Festo Core Range, we have selected the most important products and functions from our broad product catalogue, and added the quickest delivery.

The Core Range offers you the best value for your automation tasks.

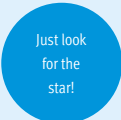

Key features

At a glance

- Universal servo drive for PM-synchronous servo motors with up to 12000 W continuous power
- Supports the motor series EMMT-AS, EMME-AS and EMMB-AS as well as third-party motors
- Integrated single-phase/three-phase mains connection 230/400 V AC, mains filter and braking resistor, connection option for external braking resistor
- Precise torque, speed and position control
- Motion from point-to-point to interpolated motion
- Comprehensively integrated protective functions for the servo drive, motor and axis with automatic motor shut-down/quick stop
- Bus protocols
- Configuration:
 - Automatically with the "Festo Automation Suite" as well as auto-tuning
 - Directly via fieldbus and PLC
 - Data backup concept via PLC or operating panel CDSB
- Supports digital absolute encoders (EnDat, Hiperface, Nikon-A) in the motor as well as incremental (A/B, Sin/Cos) displacement encoders on the axis
- Integrated safety functions:
 - Safe torque off (STO) up to SIL3/Cat. 4 PL e
 - Safe stop 1 (SS1) when using a suitable external safety relay unit and suitable circuitry for the servo drive
 - Safe brake control (SBC) up to SIL3/Cat. 3 PL e
 - Diagnostic outputs STA and SBA for feedback of the active safety function

EtherCAT

PROFI
NET

EtherNet/IP

Modbus

- Modbus TCP is available as an additional protocol for all EtherNet/IP devices
- Prepared device description files and function blocks for integration in PLC systems

The technology in detail

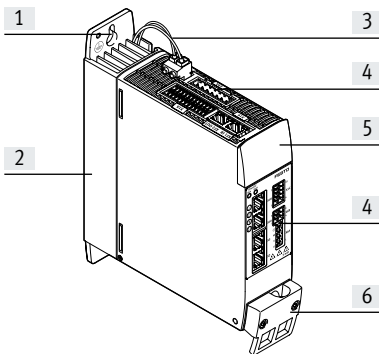

- [1] Elongated hole for mounting the servo drive on the control cabinet back wall
- [2] Cooling element for dissipating heat. The internal braking resistor is housed in the cooling element
- [3] Connection for braking resistor
- [4] Connections
- [5] Blind plate (optionally with plug-on operating panel CDSB → page 16)
- [6] Shield clamp and strain relief

Electric Motion Sizing

Configuring electromechanical drives



Create the optimum drive package quickly and reliably. Electric Motion Sizing calculates suitable combinations of electric axis, electric motor and servo drive using just a few application details. It provides you with all the relevant data including the bill of materials and documentation for the selected combination. This avoids design errors and results in significantly improved energy efficiency for the system.

A smooth connection to the Festo Automation Suite also makes commissioning easier for you.

To find out more, go to www.festo.com/ems

Key features

Library for EPLAN

→ www.festo.de/eplan

EPLAN macros for fast and reliable planning of electrical projects in combination with servo drives, motors and cables. This enables a high level of planning reliability, standardised documentation, and there is no need to create symbols, graphics and master data.

Festo Automation Suite

Parameterisation and programming software for electronic devices from Festo

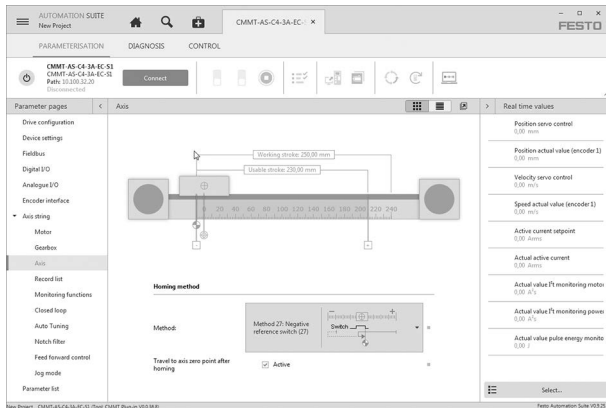

- Parameterisation, programming and commissioning in a clear and user-friendly interface
- Optimum support for complex processes thanks to guided wizards (e.g. for commissioning, drive configuration, etc.)
- Fast access to the required documents and additional information
- Easy integration of electric drives in the controller programming

System overview

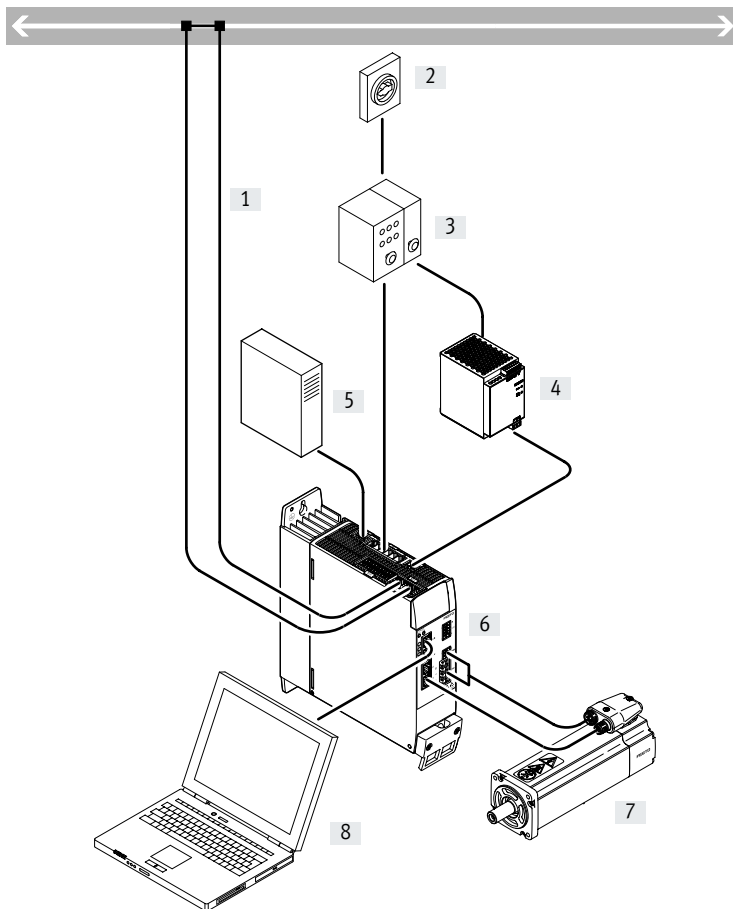

- [1] Bus/network
- [2] Main switch
- [3] Circuit breaker/fuses
- [4] Power supply unit for logic voltage supply 24 V DC (PELV)
- [5] External braking resistor (optional)
- [6] Servo drive CMMT-AS
- [7] Servo motor
- [8] PC with Ethernet connection for parameterisation

Type codes

001	Series
CMMT	Motor controller

002	Motor type
AS	AC synchronous

003	Nominal current
C2	2 A
C3	3 A
C4	4 A
C5	5 A
C7	7 A
C12	12 A
C18	18 A
C25	25 A

004	Nominal input voltage
3A	230 V AC/50-60Hz
11A	400 V AC/50-60Hz

005	Number of phases
	Single-phase
P3	Three-phase

006	Bus protocol/activation
MP	Multiprotocol

007	Safety function
S1	Standard safety

Datasheet

Bus protocols



EtherNet/IP



General technical data		C2-3A	C4-3A	C2-11A	C3-11A	C5-11A	C7-11A	C12-11A	C18-11A	C25-11A
CMMT-AS-										
Type of mounting	Mounting plate, screwed in									
Display	Green/yellow/red LED or operating panel CDSB with plain-text message									
Controller operating mode	<ul style="list-style-type: none"> • Cascade controller • P position controller • PI speed controller • PI current controller for F or M • Profile operation with record and direct mode • Interpolated mode via fieldbus • Homing/setup mode/auto-tuning 									
Operating mode	<ul style="list-style-type: none"> • Field-oriented control, position resolution 24-bit/rev. • Sampling rate 16 kHz • PWM with 8 or 16 kHz, vector modulation with third harmonic (16 kHz only with CMMT-AS-C2-3A and CMMT-AS-C4-3A) • Real-time data acquisition: <ul style="list-style-type: none"> – 2x input position capture – 2x output position trigger – 2x position encoder input – 1x SYNC interface for encoder emulation or encoder input 									
Mounting position	Vertical									
Product weight [g]	1300	1400	2100	2100	2200	4100	4100	4300	4300	4300

Bus protocols		EtherCAT®	PROFINET RT/IRT	EtherNet/IP	Modbus TCP
Interface					
Function	Bus connection incoming/outgoing				
Process interfacing	Interpolated mode CSP	AC1: adjustable-speed drives	Adjustable-speed drives	Adjustable-speed drives	Adjustable-speed drives
	Interpolated mode CSV	AC3: drives with positioning function	Drives with positioning function	Drives with positioning function	Drives with positioning function
	Interpolated mode CST	AC4: synchronous servo application			
	Point-to-point mode PP				
	Point-to-point mode PV				
	Point-to-point mode PT				
	Homing mode HM				
	Record table with 128 entries				
Communication profile	CiA402	PROFIdrive	DriveProfile	DriveProfile	DriveProfile
	CoE (CANopen over EtherCAT)				
	EoE (Ethernet over EtherCAT)				
Max. fieldbus transmission rate [Mbps]	100				
Connection type	2x bushing				
Connection technology	RJ45				

Datasheet

Electrical data		C2-3A	C4-3A	C2-11A	C3-11A	C5-11A
Output connection data						
Output voltage range	[V AC]	3x (0 – Input)				
Nominal current per phase	[A _{eff}]	2	4	1.7	2.5	5
Peak current per phase	[A _{eff}]	6	12	5.1	7.5	15
Max. peak current duration (at fs ≥ 5 Hz)	[s]	2				
Nominal power	[W]	350	700	800	1200	2500
Peak power	[W]	1000	2000	2400	3600	7500
Output frequency	[Hz]	0 ... 599				
Max. motor cable length ¹⁾	[m]	25/50		50/100		
Load voltage AC						
Nominal operating voltage phases		1-phase		3-phase		
Voltage input range	[V AC]	100 ... 230 (–20%/+15%)		200 ... 480 (–10%/+10%)		
Nominal operating voltage	[V AC]	230		400		
Nominal current	[A _{eff}]	2.8	5.6	2	3	6
Peak current		8.4	16.8	6	9	18
Mains frequency	[Hz]	48 ... 62				
System voltage in accordance with EN 61800-5-1	[V]	300				
Max. short circuit current rating of the mains	[kA]	100		10		
Mains types of system earthing		TN, TT, IT		TN, IT		
Mains filters		Built in				
Load voltage DC						
Voltage input range	[V DC]	80 ... 360		80 ... 700		
Max. intermediate circuit voltage	[V DC]	395		800		
Nominal current						
at 320 V DC	[A]	1.3	2.6	–	–	–
at 560 V DC	[A]	–	–	1.5	2.3	4.7
Logic supply						
Nominal voltage	[V DC]	24 ±20%				
Max. current consumption	[A]	0.5/2.3 ²⁾				0.5/2.5 ²⁾

- 1) Without/with external mains filter
- 2) Max. current at full expansion, with two position encoders, brake output and all I/Os with max. specified loads connected

Braking resistor		C2-3A	C4-3A	C2-11A	C3-11A	C5-11A
Integrated						
Resistance	[Ω]	100		130		
Pulse power	[kW]	1.6		5		
Pulse energy	[Ws]	230		850		
Nominal power	[W]	23		48	48	58
External						
Resistance	[Ω]	100 ... 160	67 ... 100	130 ... 250	130 ... 250	80 ... 130
Max. continuous power	[W]	180	350	400	600	1200

Datasheet

Electrical data		C7-11A	C12-11A	C18-11A	C25-11A
CMMT-AS-					
Output connection data					
Output voltage range	[V AC]	3x (0 – Input)			
Nominal current per phase	[A _{eff}]	7	12	18	25
Peak current per phase	[A _{eff}]	21	36	54	75
Max. peak current duration (at fs ≥ 5 Hz)	[s]	2			
Nominal power	[W]	4000	6000	9000	12000
Peak power	[W]	12000	18000	27000	36000
Output frequency	[Hz]	0 ... 599			
Max. motor cable length ¹⁾	[m]	25/100		50/100	
Load voltage AC					
Nominal operating voltage phases		3-phase			
Voltage input range	[V AC]	200 ... 480 (-10%/+10%)			
Nominal operating voltage	[V AC]	400			
Nominal current	[A _{eff}]	9	15	22	29
Peak current		27	45	66	87
Mains frequency	[Hz]	48 ... 62			
System voltage in accordance with EN 61800-5-1	[V]	300			
Max. short circuit current rating of the mains	[kA]	10			
Mains types of system earthing		TN, IT			
Mains filters		Built in			
Load voltage DC					
Voltage input range	[V DC]	80 ... 700			
Max. intermediate circuit voltage	[V DC]	800			
Nominal current					
at 560 V DC	[A]	7.5	11.2	17	23.5
Logic supply					
Nominal voltage	[V DC]	24 ±20%			
Max. current consumption	[A]	0.5/2.5 ²⁾		0.5/3.5 ²⁾	

1) Without/with external mains filter

2) Max. current at full expansion, with two position encoders, brake output and all I/Os with max. specified loads connected

Braking resistor		C7-11A	C12-11A	C18-11A	C25-11A
CMMT-AS-					
Integrated					
Resistance	[Ω]	47		24	
Pulse power	[kW]	13.6		24	
Pulse energy	[Ws]	1200			
Nominal power	[W]	100			
External					
Resistance	[Ω]	60 ... 85	40 ... 60	30 ... 40	20 ... 30
Max. continuous power	[W]	1500	3000	4500	5000

Datasheet

Motor auxiliary connections		C2-3A	C4-3A	C2-11A	C3-11A	C5-11A	
CMMT-AS-							
Motor temperature monitoring							
Digital	Connection for temperature switch (PTC, N/C contact or N/O contact)						
Analogue	Connection for analogue temperature sensor (KTY81 ... 84, NTC, Pt1000)						
Output for holding brake							
Version	High-side switch; 24 V; monitored internally						
Output current	[A]	1.0				1.3	
Output for 2nd brake							
Version	High-side switch; 24 V; monitored internally						
Output current	[A]	0.1					

Motor auxiliary connections		C7-11A	C12-11A	C18-11A	C25-11A	
CMMT-AS-						
Motor temperature monitoring						
Digital	Connection for temperature switch (PTC, N/C contact or N/O contact)					
Analogue	Connection for analogue temperature sensor (KTY81 ... 84, NTC, Pt1000)					
Output for holding brake						
Version	High-side switch; 24 V; monitored internally					
Output current	[A]	1.5			2.3	
Output for 2nd brake						
Version	High-side switch; 24 V; monitored internally					
Output current	[A]	0.1				

Datasheet

Interfaces		
Ethernet		
Function	Parameterisation and commissioning	
Protocol	DHCP	
	TCP/IP	
Position encoders		
Function of position encoder 1	ENDAT 2.1 encoder	
	ENDAT 2.2 encoder	
	HIPERFACE encoder	
	Incremental encoder	
	SIN/COS encoder	
	BISS-C	
	Nikon-A	
Function of position encoder 2	Incremental encoder	
	ENDAT 2.2 encoder	
	HIPERFACE encoder	
	SIN/COS encoder	
Synchronisation		
Function	Encoder emulation A/B/Z	
	Encoder input A/B/Z	
Encoder output, characteristics	1 MHz maximum output frequency	
	Resolution up to 16384 ppr	
Encoder input, characteristics	1 MHz maximum input frequency	
	Resolution up to 16384 ppr	
Input/output		
Digital inputs		
Number	10 ... 12 (depending on device design)	
Number of high-speed	2	
Time resolution of high-speed	[μ s]	1
Switching logic	PNP	
Characteristics	Not galvanically isolated	
	Freely configurable in some cases	
	Safety inputs in some cases	
Specification	Based on IEC 61131-2, type 3	
Operating range	[V]	0 ... 30
Digital outputs		
Number	4 ... 6 (depending on device design)	
Number of high-speed	2	
Time resolution of high-speed	[μ s]	1
Switching logic	PNP	
Characteristics	Not galvanically isolated	
	Freely configurable in some cases	
Max. current	[mA]	20
Analogue setpoint inputs		
Number	1	
Characteristics	Differential input	
	Configurable for current/force, rotational speed and position	
Operating range	[V]	± 10
Impedance	[k Ω]	70
Floating switching outputs		
Number	1	
Max. current	[mA]	50

Datasheet

Safety characteristics		
Safety function to EN 61800-5-2		Safe torque off (STO) Safe stop 1 (SS1) Safe brake control (SBC)
Performance Level (PL) to EN ISO 13849-1		
Safe torque off (STO)		Category 4, Performance Level e
Safe brake control (SBC)		Category 3, Performance Level e
Safety integrity level (SIL) to EN 62061 and EN 61508		
Safe torque off (STO)		SIL 3/SILCL 3
Safe brake control (SBC)		SIL 3/SILCL 3
Certificate issuing authority and no.		German Technical Control Board (TÜV) Rheinland 01/205/5640.01/23
Proof test interval		
Safe torque off (STO)		Up to 20a
Safe brake control (SBC)		24 h
Diagnostic coverage	[%]	Up to 97
Safe failure fraction (SFF)	[%]	Up to 99
Hardware fault tolerance		1
Operating and environmental conditions		
Degree of protection		IP20
Ambient temperature ¹⁾	[°C]	0 ... +50
Storage temperature	[°C]	-25 ... +55
Relative humidity	[%]	5 ... 90 (non-condensing)
Protection class		I
Overvoltage category		III
Pollution degree		2
Surge resistance	[kV]	6
Max. setup altitude ²⁾	[m]	2000
Shock and vibration resistance		To EN 61800-2 and EN 61800-5-1
CE marking (see declaration of conformity)		To EU EMC Directive ³⁾ To EU Machinery Directive To EU Low Voltage Directive To EU RoHS Directive
UKCA marking (see declaration of conformity)		To UK EMC regulations To UK RoHS regulations To UK regulations for machines
KC marking		KC EMC
Certification		c UL us - Listed (OL) RCM
LABS (PWIS) conformity		VDMA24364 zone III
Note on materials		RoHS-compliant

1) Above 40 °C, the power is reduced by 3% per K.

2) Above 1000 m, the power is reduced by 1% per 100 m.

3) For information about the area of use, see the EC declaration of conformity at: www.festo.com/sp → Certificates.

If the devices are subject to usage restrictions in residential, commercial or light-industrial environments, further measures for the reduction of the emitted interference may be necessary.

Datasheet

View of servo drives

Front view

- [1] PE connection, housing
- [2] [X5] Connection for operating panel (behind blind plate)
- [3] [X18] Standard Ethernet
- [4] [X10] Device synchronisation
- [5] [X3] Position sensor 2
- [6] [X2] Position sensor 1
- [7] [X9B] Connection for braking resistor
- [8] [X1C] Inputs/outputs for the axis
- [9] [X6B] Motor auxiliary connection
- [10] [X6A] Motor phase connection
- [11] Shield clamp and strain relief
- [12] DIL switch for the manual changeover of the fieldbuses

CMMT-AS-...-3A

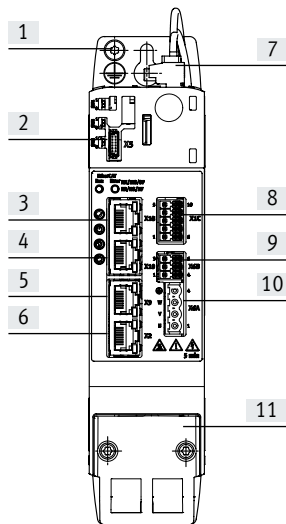

CMMT-AS-C2/C3/C5-...-11A

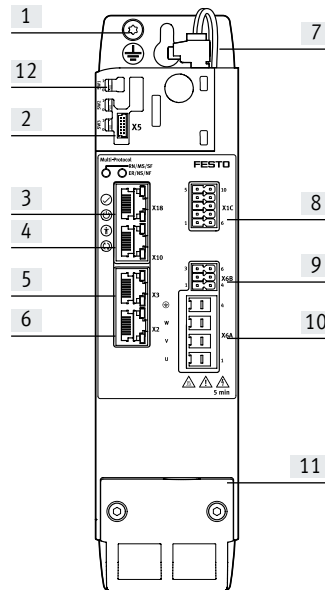

CMMT-AS-C7/C12/C18/C25-...-11A

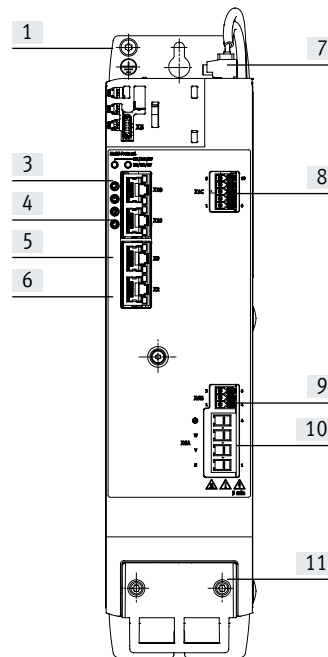

Top view

- [1] Cooling element
- [2] [X1A] I/O interface
- [3] [XF2 OUT] RTE interface port 2
- [4] [XF1 IN] RTE interface port 1
- [5] [X9B] Connection for braking resistor
- [6] [X9A] Supply: mains, DC link and logic voltage
- [7] [X9A] Supply: mains and DC link voltage
- [8] [X9C] Supply: logic voltage

CMMT-AS-...-3A

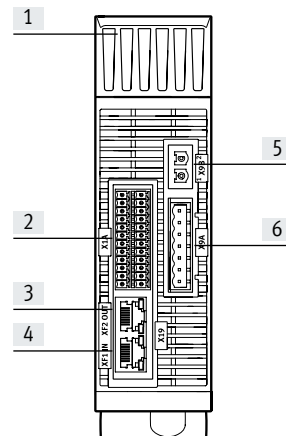

CMMT-AS-C2/C3/C5-...-11A

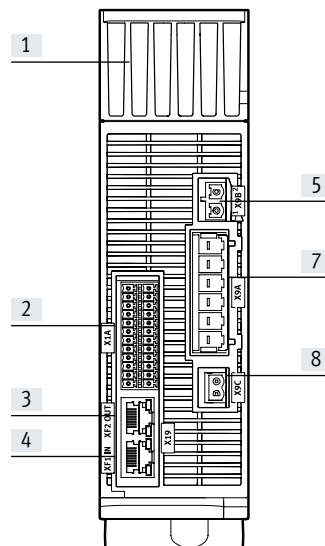

CMMT-AS-C7/C12/C18/C25-...-11A

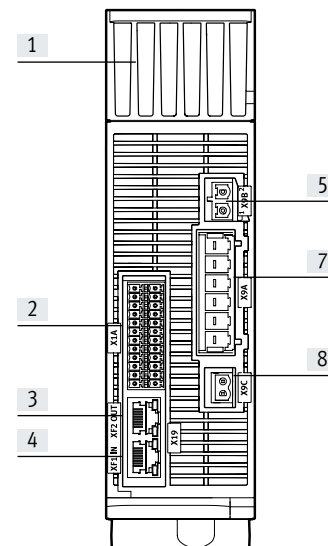

Datasheet

Installation clearance for servo drives

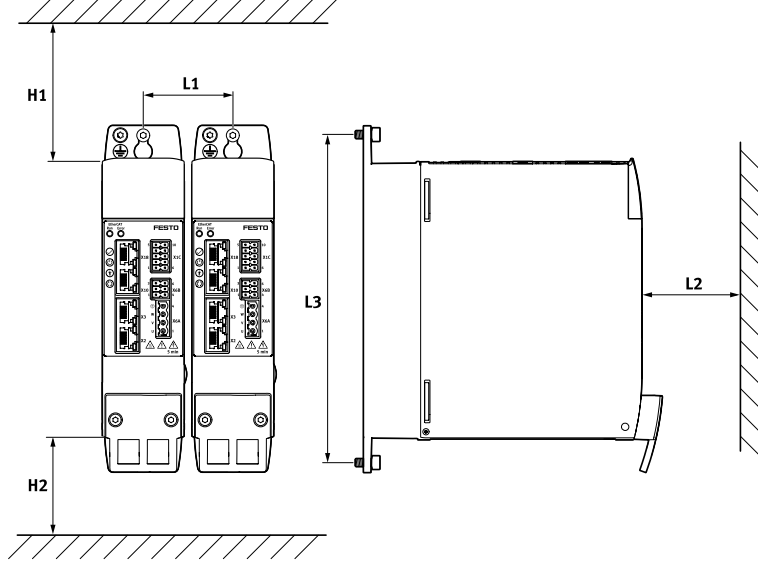

Type	H1	H2 ¹⁾	L1	L2	L3
CMMT-AS-C2-3A	70	70	52	70	200
CMMT-AS-C4-3A					
CMMT-AS-C2-11A	100	70	62	70	230
CMMT-AS-C3-11A					
CMMT-AS-C5-11A					
CMMT-AS-C7-11A	100	70	78	70	300
CMMT-AS-C12-11A					
CMMT-AS-C18-11A					
CMMT-AS-C25-11A					

1) An installation clearance of 150 mm underneath the servo drive is recommended for optimum wiring of the motor or encoder cable

Datasheet

Dimensions

Download CAD data → www.festo.com

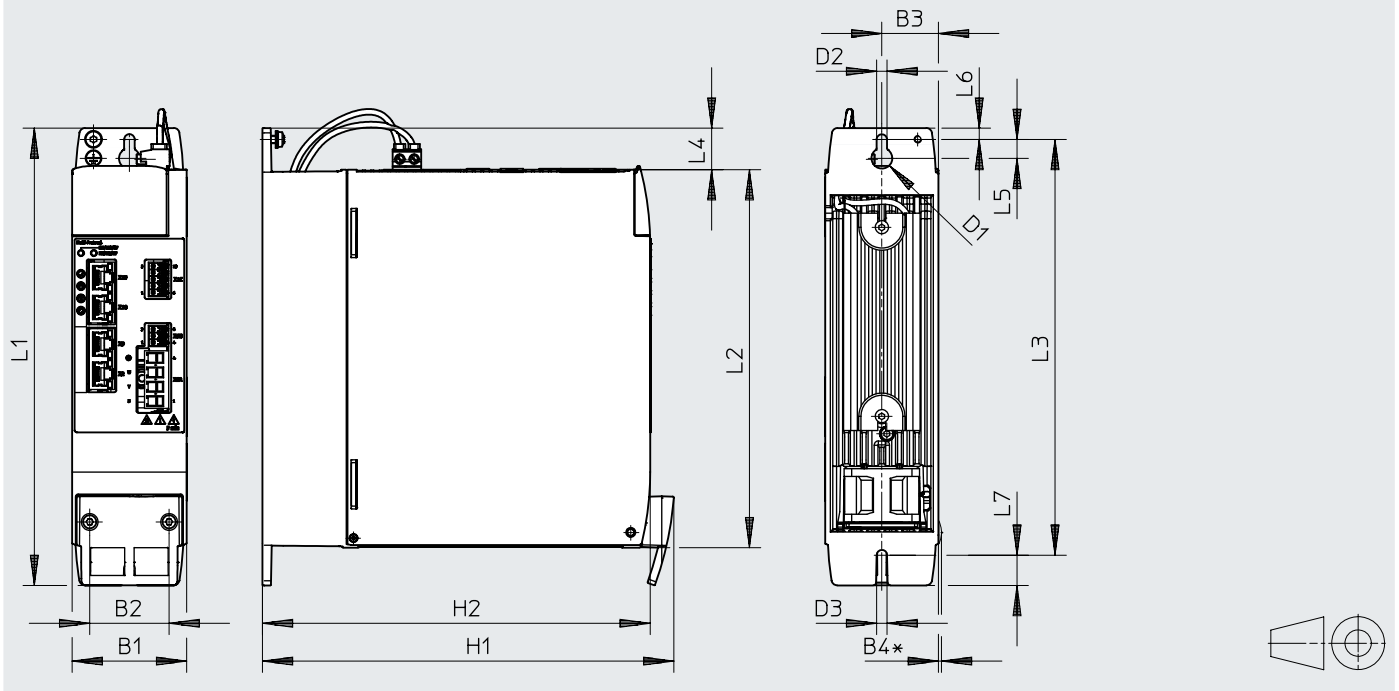

Type	B1	B2	B3	B4	D1 ∅	D2	D3	H1
CMMT-AS-C2-3A	50	34	25	-	11	5.5	5.5	183
CMMT-AS-C4-3A								
CMMT-AS-C2-11A	60	42	29.7	1.6	11	5.5	5.5	218
CMMT-AS-C3-11A								
CMMT-AS-C5-11A								
CMMT-AS-C7-11A	75	44	37.5	1.6	11	5.5	5.5	224
CMMT-AS-C12-11A								
CMMT-AS-C18-11A								
CMMT-AS-C25-11A								

Type	H2	L1	L2	L3	L4	L5	L6	L7
CMMT-AS-C2-3A	170	212	170	200	22	10	6	9
CMMT-AS-C4-3A								
CMMT-AS-C2-11A	205	242	198	220	22	10	6	16
CMMT-AS-C3-11A								
CMMT-AS-C5-11A								
CMMT-AS-C7-11A	205	319	276	300	22	10	6	13
CMMT-AS-C12-11A								
CMMT-AS-C18-11A								
CMMT-AS-C25-11A								

Datasheet

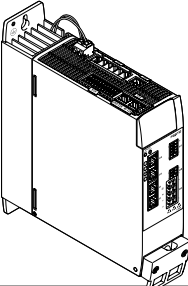
Ordering data	Description	Number of phases	Nominal current	Part no.	Type
	The assortment of plugs NEKM (→ page 16) is included in the scope of delivery of the servo drive.	1-phase	2	★ 8143163	CMMT-AS-C2-3A-MP-S1
		4	★ 8143164	CMMT-AS-C4-3A-MP-S1	
		3-phase	2	★ 8143165	CMMT-AS-C2-11A-P3-MP-S1
		3	★ 8143166	CMMT-AS-C3-11A-P3-MP-S1	
		5	★ 8143167	CMMT-AS-C5-11A-P3-MP-S1	
		7	★ 8143168	CMMT-AS-C7-11A-P3-MP-S1	
		12	★ 8143169	CMMT-AS-C12-11A-P3-MP-S1	
		18	★ 8157801	CMMT-AS-C18-11A-P3-MP-S1	
		25	★ 8157802	CMMT-AS-C25-11A-P3-MP-S1	

Ordering data – Modular product system

Ordering table					
Series			Condi- tions	Code	Enter code
CMMT-AS-...	-3A	-11A			
Module no.	5111184	5111189			
Series	CMMT			CMMT	CMMT
Motor type	AC synchronous			-AS	-AS
Nominal current					
2 A				-C2	
3 A	–		[1]	-C3	
4 A		–	[2]	-C4	
5 A	–		[1]	-C5	
7 A	–		[1]	-C7	
12 A	–		[1]	-C12	
18 A	–		[1]	-C18	
25 A	–		[1]	-C25	
Nominal input voltage					
230 VAC/50-60 Hz		–		-3A	
400 VAC	–			-11A	
Number of phases					
Single-phase		–			
Three-phase	–			-P3	
Bus protocol/activation	Multiprotocol			-MP	
Safety function	Standard safety			-S1	-S1

[1] C3, C5, C7, C12, C18, C25 Only with nominal input voltage 11A
 [2] C4) Only with nominal input voltage 3A

Accessories

Ordering data – Included in the scope of delivery of the servo drive

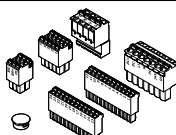
	Description	For CMMT-AS...		Part no.	Type
		-3A	-11A		
Assortment of plugs					
	For single wiring connection	■	-	★ 4325822	NEKM-C6-C16-S
	For double wiring connection	■	-	★ 5054513	NEKM-C6-C16-D
	For single wiring connection	-	■	★ 5119205	NEKM-C6-C45-P3-S
	For double wiring connection	-	■	★ 5118001	NEKM-C6-C45-P3-D
	The assortment of plugs for double wiring connection is always supplied with the servo drive.				

Ordering data – Optional accessories

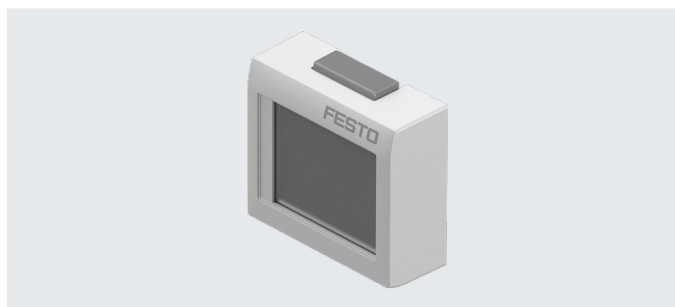

Operating panel CDSB-A1

- Text messages can be displayed in full. This allows errors, warnings and selected data to be read at a glance
 - Easy data backup of parameters and firmware in the unit for e.g. serial commissioning or device replacement
 - One operating panel can be used for several servo drives
- Control element: Touchscreen
 - Display: colour TFT
 - Display size: 1.77"
 - User memory: 3 GB
 - USB interface: USB 2.0 type mini
- Additional technical data:
→ Internet: cdsb

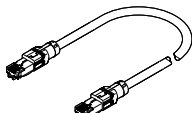

Ambient temperature [°C]	Storage temperature [°C]	Degree of protection	Weight [g]	Part no.	Type
0 ... 60	-20 ... +70	IP20	40	★ 8070984	CDSB-A1
Not included in the scope of delivery of the servo drive					

Ordering data – Optional accessories

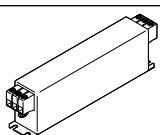
	Description	Part no.	Type
Connecting cable			
	<ul style="list-style-type: none"> Patch cable for the daisy-chain connection of the bus interfaces X19A/B Patch cable for master/slave functionality (X10-X11) Ethernet category Cat 5e Not included in the scope of delivery of the servo drive 	★ 8082383	NEBC-R3G8-KS-0.2-N-S-R3G8-ET
Mains filters			
	Single-phase, 8 A, sufficient for: 2x CMMT-AS-C2-3A or 1x CMMT-AS-C4-3A	★ 8088928	CAMF-C6-F-C8-3A
	Single-phase, 20 A, sufficient for: 6x CMMT-AS-C2-3A or 3x CMMT-AS-C4-3A	★ 8088929	CAMF-C6-F-C20-3A
	Three-phase, 16 A, sufficient for: 8x CMMT-AS-C2-11A or 5x CMMT-AS-C3-11A or 2x CMMT-AS-C5-11A or 2x CMMT-AS-C7-11A or 1x CMMT-AS-C12-11A	8096868	CAMF-C6-F-C16-11A
	3-phase, 42 A, sufficient for: 21x CMMT-AS-C2-11A or 14x CMMT-AS-C3-11A or 7x CMMT-AS-C5-11A or 5x CMMT-AS-C7-11A or 3x CMMT-AS-C12-11A or 1x CMMT-AS-C18-11A or 1x CMMT-AS-C25-11A	8096894	CAMF-C6-F-C42-11A
Not included in the scope of delivery of the servo drive			

Accessories

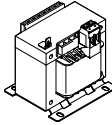
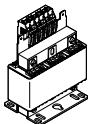
Ordering data – Optional accessories					
Description		Part no.	Type		
Line choke					
	Single-phase, 6 A, sufficient for: 2x CMMT-AS-C2-3A or 1x CMMT-AS-C4-3A	★ 8088930	CAMF-C6-FD-C6-3A		
	Three-phase, 6 A, sufficient for: 3x CMMT-AS-C2-11A or 2x CMMT-AS-C3-11A or 1x CMMT-AS-C5-11A	8096867	CAMF-C6-FD-C6-11A		
Not included in the scope of delivery of the servo drive					

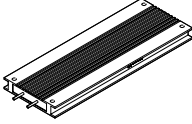
Ordering data – Optional accessories						Datasheets → Internet: cacr	
		Resistance value [Ω]	Nominal power at 380 V [W]	Pulse energy at 380 V [Ws]	Part no.	Type	
Braking resistor							
							
For type CMMT-AS-							
C2-3A	C4-3A						
–	■	72	150	2000	1336611	CACR-LE2-72-W500	
■	■	100	150	2000	1336615	CACR-LE2-100-W500	
–	■	67	720	10800	1336617	CACR-KL2-67-W1800	
■	■	100	720	10800	8091545	CACR-KL2-100-W1800	
Not included in the scope of delivery of the servo drive							

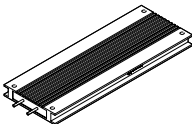

Ordering data – Optional accessories						Datasheets → Internet: cacr			
		Resistance value [Ω]	Nominal power at 780 V [W]	Pulse energy at 780 V [Ws]	Part no.	Type			
Braking resistor									
									
For type CMMT-AS-									
C2-11A	C3-11A	C5-11A	C7-11A	C12-11A					
–	–	–	–	■	50	120	1800	2882342	CACR-LE2-50-W500
–	–	–	■	–	72	120	1800	1336611	CACR-LE2-72-W500
–	–	■	–	–	100	120	1800	1336615	CACR-LE2-100-W500
■	■	–	–	–	240	120	1800	8091543	CACR-LE2-240-W500
–	–	–	–	■	40	480	7200	2882343	CACR-KL2-40-W2000
–	–	–	■	–	67	720	10800	1336617	CACR-KL2-67-W1800
■	■	–	–	–	240	720	10800	8091544	CACR-KL2-240-W1800
–	–	■	–	–	100	720	10800	8091545	CACR-KL2-100-W1800
Not included in the scope of delivery of the servo drive									

Accessories

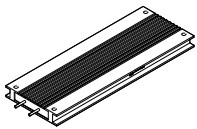
Datasheets → Internet: cacr

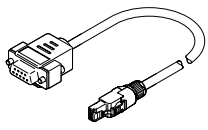
Ordering data – Optional accessories		Resistance value	Nominal power at 780 V	Pulse energy at 780 V	Part no.	Type
		[Ω]	[W]	[Ws]		
Braking resistor						
						
For type CMMT-AS-						
C18-11A	C25-11A					
■	–	40	480	7200	2882343	CACR-KL2-40-W2000
–	■	21	1440	21600	8140961	CACR-KL2-21-W3600
Not included in the scope of delivery of the servo drive						

Ordering data – Optional accessories		Description	Part no.	Type
Adapter				
		Required in combination with the linear drives EGC...-M1/M2, ELGA...-M1/M2 or ELCC...-M1 (external displacement encoder) as adapter between encoder cable NEBM-M12G8...-V3 and interface X3 (position encoder 2)	8106112	NEFM-S1G9-K-0.5-R3G8
Not included in the scope of delivery of the servo drive				

Ordering data – Optional accessories		Description	For CMMT-AS-			Part no.	Type
			C2/C4 ...-3A	C2/C3/C5 ...-11A	C7/C12/ C18/C25 ...-11A		
Blanking plate							
		<ul style="list-style-type: none"> Used to cover the connections if no operating panel is used Included in the scope of delivery of the servo drive 	■	■	■	★ 5395254	CAFC-06-C
Shield clamp							
		<ul style="list-style-type: none"> For fitting the shield and strain relief for the motor cable Included in the scope of delivery of the servo drive 	■	–	–	5326867	CAMA-C6-SK-S2
			–	■	–	5335956	CAMA-C6-SK-S3
			–	–	■	★ 8114689	CAMA-C6-SK-S4