

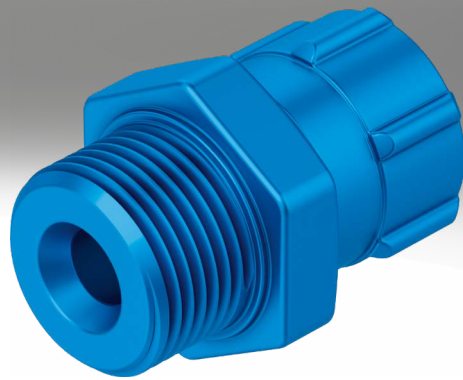





Quick connectors





FESTO







Product range overview

Design	Version	Type	Connection D1		Tubing I.D.	→ Page
			M thread	G thread		
Straight shape	Quick connector – female thread with sealing ring					
		ACK Aluminium design	–	G1/8	3, 4, 6	5
				G1/4	4, 6	
				G3/8	6, 9	
				G1/2	13	
	Quick connector – male thread with sealing ring					
		CK Metal design	M5	–	3, 4	6
			–	G1/8	3, 4, 6	
			–	G1/4	4, 6, 9	
			–	G3/8	6, 9, 13	
			–	G1/2	13	
	CK...-KU Polymer design	–	G1/8	3, 4, 6	8	
		–	G1/4	4, 6, 9		
		–	G3/8	6, 9		
	Bulkhead quick connector – female thread with sealing ring					
		QCK	M5	–	PK-3	9
			–	G1/8	PK-4	
			–	G1/4	PK-6	
–			G3/8	PK-9		
Bulkhead quick connector						
	SCK Aluminium design	–	–	PK-3, PK-4, PK-6, PK-9	10	
	SCK...-KU Polymer design	–	–	PK-3, PK-4, PK-6, PK-9	10	
Sealing cap for plastic tube fittings and barbed connectors						
	CV-PK	–	–	3, 4, 6, 9	12	

Product range overview

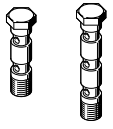
Design	Version	Type	Connection D1			Tubing I.D.	→ Page
			M thread	R thread	G thread		
L-shape	Elbow quick connector						
		GCK-...-KU Polymer design	-	R1/8	-	4, 6	13
				R1/4		4, 6	
				R3/8		6, 9	
	Elbow quick connector with 2 sealing rings, rotatable						
		LCK Metal design	M5	-	-	3, 4	14
			-		G1/8	3, 4, 6	
			-		G1/4	4, 6, 9	
			-		G3/8	6, 9, 13	
			-		G1/2	13	
LCK-...-KU Polymer design	-	-	G1/8	4, 6	14		
	-	-	G1/4	4, 6			
T-shape	T quick connector with 2 sealing rings, rotatable						
		TCK Metal design	M5	-	-	3, 4	16
			-		G1/8	3, 4, 6	
			-		G1/4	4, 6,	
			-		G3/8	6, 9	
			-		G1/2	13	
	TCK-...-KU Polymer design	-	-	G1/8	4, 6	16	
		-	-	G1/4	4, 6		
	T-distributor						
		FCK-...-KU	-	-	-	3	18
4							
6							
9							
Union nut for CK tube fitting							
	MCK Metal design	-	-	-	3, 4, 6, 9, 13	19	
	MCK-...-KU Polymer design	-	-	-	3, 4, 6, 9		

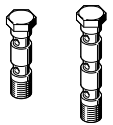
Product range overview

Design	Version	Type	Connection D1		Tubing I.D.	→ Page
			M thread	G thread		
Multiple distributor	Combination of hollow bolt VT with ring piece LK					
		VT...-2 For 2 ring pieces	M5	G1/8, G1/4, G3/8	–	20
		VT...-3 For 3 ring pieces	M5	G1/8, G1/4, G3/8	–	20
		LK Metal design	–	–	3, 4, 6	20
		LK...-KU Polymer design	–	–	4, 6	20
	Combination of hollow bolt VT with ring piece TK					
		VT...-2 For 2 ring pieces	M5	G1/8, G1/4, G3/8	–	21
		VT...-3 For 3 ring pieces	M5	G1/8, G1/4, G3/8	–	21
		TK Metal design	–	–	3, 4, 6	21
		TK...-KU Polymer design	–	–	4, 6	21

Datasheet

Quick connector ACK

Female thread with sealing ring



General technical data		
Mounting position	Any	
Design	Straight shape	
Type of seal on the screwed trunnion	Sealing ring	
Operating and environmental conditions		
Operating pressure for full temperature range	[MPa]	-0.095 ... +1
	[bar]	-0.95 ... +10
	[psi]	-13.775 ... +145
Note on the operating pressure	Water: max. 0.6 MPa at max. 50°C	
Operating medium	Compressed air to ISO 8573-1:2010 [7:::] Water (liquid, ice-free)	
Note on the operating/pilot medium	Lubricated operation possible; water: G thread only possible with OL sealing ring	
Ambient temperature	[°C]	-10 ... +60
Corrosion resistance class CRC ¹⁾		2 - Moderate corrosion stress

1) More information www.festo.com/x/topic/crc

Materials	
Union nut material	Anodised wrought aluminium alloy
Screwed plug material	Anodised wrought aluminium alloy
Sealing ring material	Reinforced PA TPE-U(PU)
Note on materials	RoHS-compliant
LABS (PWIS) conformity	VDMA24364-B1/B2-L

Dimensions

Download CAD data → www.festo.com

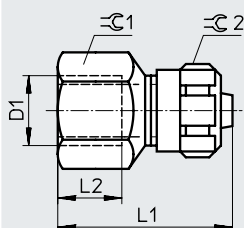

Ordering data			Nominal width	Nominal tightening torque	L1	L2	$\varnothing 1$	$\varnothing 2$	Part no.	Type	PU ²⁾	
Pneumatic connection	Female thread	For tubing O.D.										
		For barbed connector I.D. ¹⁾	[mm]	[Nm]								
	D1	[mm]	[mm]	[Nm]								
	G1/8	4	3	2.4	3.5 ±20%	23.9	9	13	8	5664	ACK-1/8-PK-3	10
		6	4	3.4	3.5 ±20%	27	9	13	12	3714	ACK-1/8-PK-4	10
		8	6	5.3	3.5 ±20%	27	9	13	14	7842	ACK-1/8-PK-6	10
	G1/4	6	4	3.4	11 ±10%	30	12	17	12	3713	ACK-1/4-PK-4	10
		8	6	5.3	11 ±10%	30	12	17	14	3712	ACK-1/4-PK-6	10
	G3/8	8	6	5.3	12.5 ±20%	31	12	19	14	3711	ACK-3/8-PK-6	10
		-	9	8	12.5 ±20%	37.4	15	19	19	3710	ACK-3/8-PK-9	10
	G1/2	-	13	12	14 ±20%	40.2	15	27	24	4099	ACK-1/2-PK-13	1

1) With union nut

2) Packaging unit

Datasheet

Quick connector CK

Metal design
Male thread with sealing ring

Materials:
Screwed trunion
M thread: Galvanised steel
G thread: Aluminium
Union nut: Aluminium

Note on materials:
RoHS-compliant



General technical data

Mounting position	Any
Design	Straight shape
Type of seal on the screwed trunion	Sealing ring

Operating and environmental conditions

Type	M thread	G thread
Operating pressure for full temperature range	[MPa]	-0.095 ... +1
	[bar]	-0.95 ... +10
	[psi]	-13.775 ... +145
Note on the operating pressure	Water: max. 0.6 MPa at max. 50°C	
Operating medium	Compressed air to ISO 8573-1:2010 [7:::] Water (liquid, ice-free)	
Note on the operating/pilot medium	Lubricated operation possible	Lubricated operation possible Water: G thread only possible with OL sealing ring
Ambient temperature	[°C]	-10 ... +60
Corrosion resistance class CRC ¹⁾	1 - Low corrosion stress	2 - Moderate corrosion stress

1) More information www.festo.com/x/topic/crc

Materials

Type	M thread	G thread
Union nut material	Anodised wrought aluminium alloy	
Screwed plug material	Galvanised steel	Anodised wrought aluminium alloy
Sealing ring material	NBR High-alloy stainless steel	Reinforced PA TPE-U(PU)
Note on materials	RoHS-compliant	
LABS (PWIS) conformity	VDMA24364-B1/B2-L	

Datasheet

Dimensions

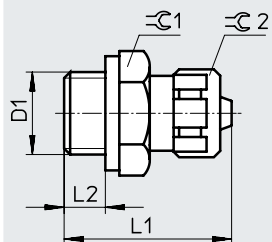
Download CAD data → www.festo.com

Ordering data

Pneumatic connection			Nominal width [mm]	Nominal tightening torque [Nm]	L1	L2	$\varnothing 1$	$\varnothing 2$	Part no.	Type	PU ²⁾
Male thread	For tubing O.D. [mm]	For barbed connector I.D. ¹⁾ [mm]									
M5	4	3	2.0	1.33 ±20%	19.3	3.8	7	8	3561	CK-M5-PK-3	10
	6	4	2.9	1.33 ±20%	21.5	3.8	10	–	3562	CK-M5-PK-4	10
G1/8B	4	3	2.0	3.5 ±20%	21.6	4.9	13	8	3563	CK-1/8-PK-3	10
	6	4	2.9	3.5 ±20%	24.7	4.9	13	12	2027	CK-1/8-PK-4	10
	8	6	4.9	3.5 ±20%	24.8	4.9	13	14	2028	CK-1/8-PK-6	10
G1/4B	6	4	2.9	11 ±10%	27.2	5.8	17	12	2029	CK-1/4-PK-4	10
	8	6	4.9	11 ±10%	27.3	5.8	17	14	2030	CK-1/4-PK-6	10
	–	9	8	11 ±10%	30.6	5.8	17	19	2031	CK-1/4-PK-9	10
G3/8B	8	6	4.9	12.5 ±20%	28.3	6.8	19	14	2032	CK-3/8-PK-6	10
	–	9	8	12.5 ±20%	31.6	6.8	19	19	2033	CK-3/8-PK-9	10
	–	13	11.7	12.5 ±20%	33.2	6.8	24	24	4097	CK-3/8-PK-13	10
G1/2B	–	13	11.7	14 ±20%	34.7	8.5	24	24	4098	CK-1/2-PK-13	1

1) With union nut

2) Packaging unit

Datasheet

Quick connector CK-...-KU

Polymer design
Male thread with moulded-on sealing edge

Materials:
Screwed trunion: POM
Union nut: POM

Note on materials:
RoHS-compliant



General technical data	
Mounting position	Any
Design	Straight shape
Type of seal on the screwed trunion	Sealing edge

Operating and environmental conditions		
Operating pressure for full temperature range	[MPa]	-0.095 ... +1
	[bar]	-0.95 ... +10
	[psi]	-13.775 ... +145
Note on the operating pressure	Water: max. 0.6 MPa at max. 50°C	
Operating medium	Compressed air to ISO 8573-1:2010 [7:::] Water (liquid, ice-free)	
Note on the operating/pilot medium	Lubricated operation possible	
Ambient temperature	[°C]	-10 ... +60

Materials	
Union nut material	POM
Screwed plug material	POM
Note on materials	RoHS-compliant
LABS (PWIS) conformity	VDMA24364-B1/B2-L

Dimensions

Download CAD data → www.festo.com

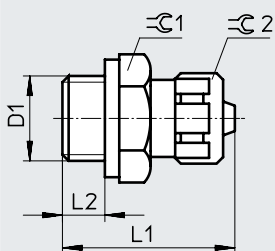

Ordering data			Nominal width	Nominal tightening torque	L1	L2	≙G1	≙G2	Part no.	Type	PU ²⁾
Pneumatic connection											
Male thread	For tubing O.D.	For barbed connector I.D. ¹⁾	[mm]	[Nm]							
G1/8	4	3	2.4	3.25 ±20%	22.2	6.5	13	8	6253	CK-1/8-PK-3-KU	10
	6	4	3.4		25.3	6.5	13	12	6254	CK-1/8-PK-4-KU	10
	8	6	4.4		25.4	6.5	13	14	6255	CK-1/8-PK-6-KU	10
G1/4	6	4	3.4	5.5 ±20%	28.5	8.5	17	12	6256	CK-1/4-PK-4-KU	10
	8	6	5.3		28.6	8.5	17	14	6257	CK-1/4-PK-6-KU	10
	-	9	7.3		31.9	8.5	17	19	6258	CK-1/4-PK-9-KU	10
G3/8	8	6	5.3	7.5 ±20%	31	10.5	19	14	6460	CK-3/8-PK-6-KU	10
	-	9	8		34.5	10.5	19	19	6468	CK-3/8-PK-9-KU	10

1) With union nut
2) Packaging unit

Datasheet

Bulkhead quick connector QCK Female thread with sealing ring

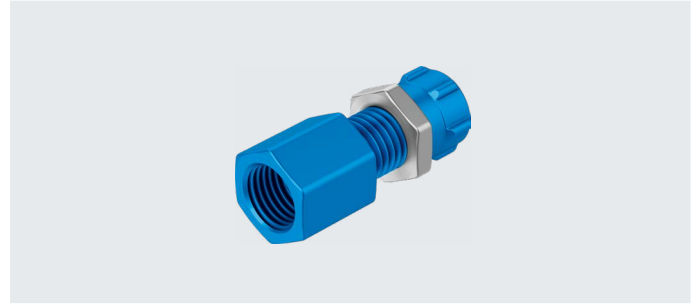

General technical data

Mounting position	Any
Design	Bulkhead
Type of seal on the screwed trunnion	Sealing ring

Operating and environmental conditions

Operating pressure for full temperature range	[MPa]	-0.095 ... +1
	[bar]	-0.95 ... +10
	[psi]	-13.775 ... +145
Operating medium	Compressed air to ISO 8573-1:2010 [7:::]	
Note on the operating/pilot medium	Lubricated operation possible	
Ambient temperature	[°C]	-10 ... +60
Corrosion resistance class CRC ¹⁾	1 - Low corrosion stress	

1) More information www.festo.com/x/topic/crc

Materials

Union nut material	Anodised wrought aluminium alloy
Nut material	Galvanised steel
Connector material	Anodised wrought aluminium alloy
Note on materials	RoHS-compliant
LABS (PWIS) conformity	VDMA24364-B1/B2-L

Dimensions

Download CAD data → www.festo.com

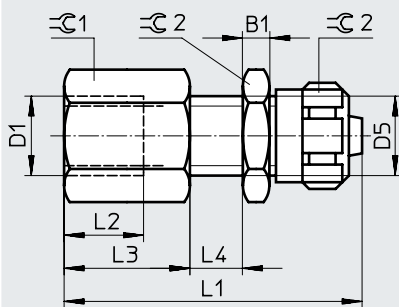

Ordering data

Pneumatic connection			Nominal width	Nominal tightening torque	B1	D5	L1	L2	L3	L4	G1	G2	G3	Part no.	Type	PU ²⁾
Male thread	For tubing O.D.	For barbed connector I.D. ¹⁾														
D1	[mm]	[mm]	[mm]	[Nm]						max.						
M5	4	3	2.4	1.33 ±20%	3.2	M6x0.75	31	6	10	8	7	8	10	9424	QCK-M5-PK-3-B	10
G1/8	6	4	3.4	3.5 ±20%	3.5	M10x1	40	8	13.5	10	13	12	13	9425	QCK-1/8-PK-4-B	10
G1/4	8	6	5.3	11 ±10%	4	M12x1	45	12	18	10	17	14	17	9426	QCK-1/4-PK-6-B	10
G3/8	-	9	8	12.5 ±20%	5	M16x1	50	12	18.6	10	19	19	22	9427	QCK-3/8-PK-9-B	1

1) With union nut

2) Packaging unit

Datasheet

Bulkhead quick connector SCK

Bulkhead quick connector SCK-...-KU

With moulded-on sealing edge



General technical data			
Mounting position	Any		
Design	Bulkhead		
Operating and environmental conditions			
Type	SCK		SCK-...-KU
Operating pressure for full temperature range	[MPa]	0 ... +1.6	-0.095 ... +1
	[bar]	0 ... +16	-0.95 ... +10
	[psi]	0 ... +232	-13.775 ... +145
Operating medium	Compressed air to ISO 8573-1:2010 [7:-:-]		
Note on the operating/pilot medium	Lubricated operation possible		
Ambient temperature	[°C]	-40 ... +150	-10 ... +60
Corrosion resistance class CRC ¹⁾	1 - Low corrosion stress		-

1) More information www.festo.com/x/topic/crc

Materials			
Type	SCK		SCK-...-KU
Union nut material	Anodised wrought aluminium alloy		POM
Nut material	Galvanised steel		POM
Connector material	Anodised wrought aluminium alloy		POM
Note on materials	RoHS-compliant		
LABS (PWIS) conformity	VDMA24364-B1/B2-L		

Datasheet

Dimensions

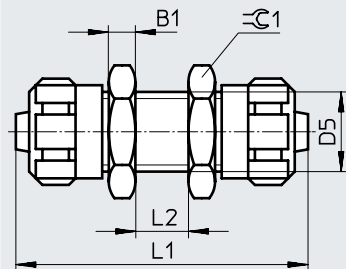
Download CAD data → www.festo.com

Ordering data

Pneumatic connection 1		Pneumatic connection 2		Nominal width	B1	D5	L1	L2	≈G1	Part no.	Type	PU ²⁾
For tubing O.D.	For barbed connector I.D. ¹⁾	For tubing O.D.	For barbed connector I.D. ¹⁾									
[mm]	[mm]	[mm]	[mm]	[mm]				max.				
Aluminium design												
4	3	4	3	2.4	3.2	M6x0.75	34	8	10	9420	SCK-PK-3	10
6	4	6	4	3.4	3.5	M10x1	43	10	13	9421	SCK-PK-4	10
8	6	8	6	5.3	4	M12x1	44	10	17	9422	SCK-PK-6	10
–	9	–	9	8	5	M16x1	53	10	22	9423	SCK-PK-9	1
Polymer design												
4	3	4	3	2.4	5	M10x1 ³⁾	41	10	13	9387	SCK-PK-3-KU	10
6	4	6	4	3.4	5	M10x1	46	10	13	9388	SCK-PK-4-KU	10
8	6	8	6	5.3	6	M12x1	48	10	17	9389	SCK-PK-6-KU	10
–	9	–	9	8	7	M16x1	57	10	22	9390	SCK-PK-9-KU	1

1) With union nut

2) Packaging unit

3) Installation diameter differs from the aluminium version

Datasheet

Sealing cap CV

Sealing cap for plastic tube fittings and barbed connectors



Operating conditions (permissible static pressure)

Temperature-dependent	[MPa]	-0.095 ... +1
Operating pressure	[bar]	-0.95 ... +10
	[psi]	-13.775 ... +145
Operating medium		Compressed air to ISO 8573-1:2010 [7:::]
Ambient temperature	[°C]	-10 ... +80

Materials

Cap material	TPE-U(PU)
Note on materials	RoHS-compliant
LABS (PWIS) conformity	VDMA24364-B2-L

Ordering data

Pneumatic connection 1		Part no.	Type	PU ²⁾
For tubing O.D. [mm]	For barbed connector I.D. ¹⁾ [mm]			
4	3	6213	CV-PK-3-B	10
6	4	6214	CV-PK-4-B	10
8	6	6215	CV-PK-6-B	10
-	9	6216	CV-PK-9-B	10

1) With union nut

2) Packaging unit

Sealing cap CV-PC-8

Sealing cap for plastic tube fittings and barbed connectors



Technical data

Operating medium		Compressed air to ISO 8573-1:2010 [7:::]
Ambient temperature	[°C]	-10 ... +60
Note on materials		RoHS-compliant
LABS (PWIS) conformity		VDMA24364-B2-L

Ordering data

		Part no.	Type	PU ¹⁾
		7637	CV-PC-8	100

1) Packaging unit

Datasheet

Elbow quick connector GCK-...-KU



General technical data		
Mounting position	Any	
Design	L-shape	
Operating and environmental conditions		
Operating pressure for full temperature range	[MPa]	-0.095 ... +1
	[bar]	-0.95 ... +10
	[psi]	-13.775 ... +145
Operating medium	Compressed air to ISO 8573-1:2010 [7:::]	
Note on the operating/pilot medium	Lubricated operation possible	
Ambient temperature	[°C]	-10 ... +60
Materials		
Union nut material	POM	
Screwed plug material	POM	
Note on materials	RoHS-compliant	
LABS (PWIS) conformity	VDMA24364-B1/B2-L	

Dimensions

Download CAD data → www.festo.com

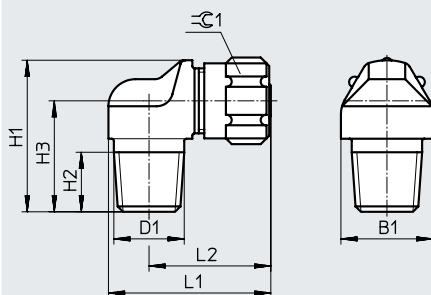

Ordering data			Nominal width	B1	H1	H2	H3	L1	L2	≅C1	Part no.	Type	PU ²⁾	
Pneumatic connection	Male thread	For tubing O.D.												
	D1	[mm]	[mm]											
	R1/8	6	4	2.9	13	22.5	8	16.5	26.5	20.5	12	6267	GCK-1/8-PK-4-KU	10
		8	6	4.9	17	24.5	8	17.5	28.5	21.5	14	6268	GCK-1/8-PK-6-KU	10
	R1/4	6	4	2.9	17	25.5	11	19.5	30	22.5	12	6269	GCK-1/4-PK-4-KU	10
		8	6	4.9	17	27.5	11	20.5	30	22.5	14	6270	GCK-1/4-PK-6-KU	10
	R3/8	8	6	4.9	19	28.5	10.5	21	34	24.5	14	6271	GCK-3/8-PK-6-KU	10
		-	9	8	19	33.5	10.5	23.5	37.2	27.7	19	6272	GCK-3/8-PK-9-KU	10

1) With union nut

2) Packaging unit

Datasheet

Elbow quick connector LCK

With 2 sealing rings
Rotatable

Elbow quick connector

LCK...-KU

With moulded-on sealing edge
Rotatable



General technical data		
Type	LCK	LCK...-KU
Mounting position	Any	
Design	L-shape	
Type of seal on the screwed trunnion	Sealing ring	Sealing edge

Operating and environmental conditions		
Type	LCK	LCK...-KU
Operating pressure for full temperature range	[MPa]	-0.095 ... +1
	[bar]	-0.95 ... +10
	[psi]	-13.775 ... +145
Operating medium	Compressed air to ISO 8573-1:2010 [7:::]	
Note on the operating/pilot medium	Lubricated operation possible	
Ambient temperature	[°C]	-10 ... +60
Corrosion resistance class CRC ¹⁾	1 - Low corrosion stress	2 - Moderate corrosion stress

1) More information www.festo.com/x/topic/crc

Materials			
Type	LCK (M thread)	LCK (G thread)	LCK...-KU
Union nut material	Anodised wrought aluminium alloy		POM
Swivel joint material	Die-cast zinc		POM
Hollow bolt material	Galvanised steel	Anodised wrought aluminium alloy	
Sealing ring material	NBR High-alloy stainless steel	Reinforced PA TPE-U(PU)	-
Note on materials	RoHS-compliant		
LABS (PWIS) conformity	VDMA24364-B1/B2-L		

Datasheet

Dimensions

Download CAD data → www.festo.com

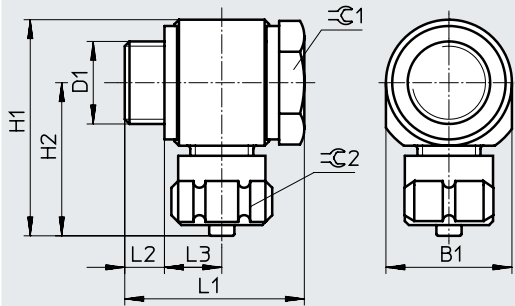

Ordering data

Pneumatic connection			Nominal width [mm]	Nominal tightening torque [Nm]	B1	H1	H2	L1	L2	L3	C1	C2	Part no.	Type	PU ²⁾
Male thread	For tubing O.D.	For barbed connector I.D. ¹⁾													
D1	[mm]	[mm]													
Die-cast zinc design															
M5	4	3	2.4	1.33 ±20%	10	21.1	16.1	17.2	3.8	5.2	7	8	4468	LCK-M5-PK-3	10
	6	4	2.4	1.33 ±20%	11	21.1	16.1	18	3.8	5.6	7	8	4562	LCK-M5-PK-4	10
G1/8	4	3	2	3.5 ±20%	16	27.1	19.1	21.1	4.9	6.1	13	8	4136	LCK-1/8-PK-3	10
	6	4	2.9	3.5 ±20%	16	30.2	22.2	27.1	4.9	9.1	13	12	4469	LCK-1/8-PK-4	10
	8	6	4.9	3.5 ±20%	16	30.3	22.3	27.1	4.9	9.1	13	14	4470	LCK-1/8-PK-6	10
G1/4	6	4	2.9	11 ±10%	20	34.2	24.2	28.1	5.7	9.2	17	12	4471	LCK-1/4-PK-4	10
	8	6	4.9	11 ±10%	20	34.3	24.3	28.1	5.5	9.3	17	14	4472	LCK-1/4-PK-6	10
	-	9	8	11 ±10%	20	37.6	27.6	33.3	5.7	11.8	17	19	11452	LCK-1/4-PK-9	10
G3/8	8	6	4.9	12.5 ±20%	25	39.3	26.8	30.3	6.7	9.3	22	14	4473	LCK-3/8-PK-6	1
	-	9	8	12.5 ±20%	25	42.6	30.1	35.3	6.7	11.8	22	19	4474	LCK-3/8-PK-9	1
G1/2	-	13	11.7	14 ±20%	30	49.2	34.2	46.6	7.9	16.85	27	24	4100	LCK-1/2-PK-13	1
Polymer design															
G1/8	6	4	3.4	-	16	30.5	22.5	27.5	7.1	8.25	13	12	6259	LCK-1/8-PK-4-KU	10
	8	6	5.3	-	16	30.5	22.5	27.5	7.1	8.25	13	14	6260	LCK-1/8-PK-6-KU	10
G1/4	6	4	3.4	-	20	34.5	24.5	28.5	8.1	8.25	17	12	6261	LCK-1/4-PK-4-KU	10
	8	6	5.3	-	20	34.5	24.5	28.5	8.1	8.25	17	14	6262	LCK-1/4-PK-6-KU	10

1) With union nut
2) Packaging unit

T quick connectors TCK

Datasheet

T quick connector TCK

With 2 sealing rings
Rotatable

T quick connector

TCK...-KU
With moulded-on sealing edge
Rotatable



General technical data		
Type	TCK	TCK...-KU
Mounting position	Any	
Design	T-shape	
Type of seal on the screwed trunion	Sealing ring	Sealing edge

Operating and environmental conditions		
Type	TCK	TCK...-KU
Operating pressure for full temperature range	[MPa]	-0.095 ... +1
	[bar]	-0.95 ... +10
	[psi]	-13.775 ... +145
Operating medium	Compressed air to ISO 8573-1:2010 [7:::]	
Note on the operating/pilot medium	Lubricated operation possible	
Ambient temperature	[°C]	-10 ... +60
Corrosion resistance class CRC ¹⁾	1 - Low corrosion stress	2 - Moderate corrosion stress

1) More information www.festo.com/x/topic/crc

Materials			
Type	TCK (M thread)	TCK (G thread)	TCK...-KU
Housing material	Die-cast zinc		POM
Union nut material	Anodised wrought aluminium alloy		POM
Swivel joint material	Die-cast zinc		POM
Hollow bolt material	Galvanised steel	Anodised wrought aluminium alloy	
Sealing ring material	NBR High-alloy stainless steel	Reinforced PA TPE-U(PU)	-
Note on materials	RoHS-compliant		
LABS (PWIS) conformity	VDMA24364-B1/B2-L		

Datasheet

Dimensions

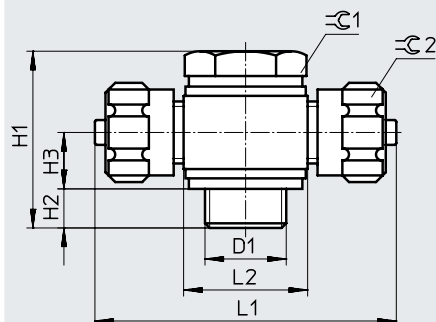
Download CAD data → www.festo.com

Ordering data

Pneumatic connection			Nominal width [mm]	Nominal tightening torque [Nm]	H1	H2	H3	L1	L2	C1	C2	Part no.	Type	PU ²⁾
Male thread	For tubing O.D.	For barbed connector I.D. ¹⁾												
D1	[mm]	[mm]												
Die-cast zinc design														
M5	4	3	2	1.33 ±20%	17.2	3.8	5.2	32.2	10	7	8	4484	TCK-M5-PK-3	10
	6	4	2	1.33 ±20%	18	3.8	5.6	39.4	11	7	8	4563	TCK-M5-PK-4	10
G1/8	4	3	2	3.5 ±20%	21.1	4.9	6.1	38.2	16	13	8	4137	TCK-1/8-PK-3	10
	6	4	2.9	3.5 ±20%	27.1	4.9	9.1	44.4	16	13	12	4485	TCK-1/8-PK-4	10
	8	6	4.9	3.5 ±20%	27.1	4.9	9.1	44.6	16	13	14	4486	TCK-1/8-PK-6	10
G1/4	6	4	2.9	11 ±10%	28.1	5.7	9.2	48.4	20	17	12	4487	TCK-1/4-PK-4	10
	8	6	4.9	11 ±10%	28.1	5.5	9.3	48.6	20	17	14	4488	TCK-1/4-PK-6	10
G3/8	8	6	4.9	12.5 ±20%	30.3	6.7	9.3	53.6	25	22	14	4489	TCK-3/8-PK-6	1
	–	9	8	12.5 ±20%	35.3	6.7	11.8	60.2	25	22	14	4490	TCK-3/8-PK-9	1
G1/2	–	13	11.7	14 ±20%	46.6	7.9	16.9	68.4	30	27	24	4101	TCK-1/2-PK-13	1
Polymer design														
G1/8	6	4	3.4	–	27.5	7.1	8.25	45	16	13	12	6263	TCK-1/8-PK-4-KU	10
	8	6	5.3	–	27.5	7.1	8.25	45	16	13	14	6264	TCK-1/8-PK-6-KU	10
G1/4	6	4	3.4	–	28.5	8.1	8.25	49	20	17	12	6265	TCK-1/4-PK-4-KU	10
	8	6	5.3	–	28.5	8.1	8.25	49	20	17	14	6266	TCK-1/4-PK-6-KU	10

1) With union nut

2) Packaging unit

Datasheet

T-distributor FCK-...-KU



General technical data

Mounting position	Any
Design	T-shape

Operating and environmental conditions

Operating pressure for full temperature range	[MPa]	-0.095 ... +1
	[bar]	-0.95 ... +10
	[psi]	-13.775 ... +145
Operating medium	Compressed air to ISO 8573-1:2010 [7:::]	
Note on the operating/pilot medium	Lubricated operation possible	
Ambient temperature	[°C]	-10 ... +60

Materials

Union nut material	POM
Connector material	POM
Note on materials	RoHS-compliant
LABS (PWIS) conformity	VDMA24364-B1/B2-L

Dimensions

Download CAD data → www.festo.com

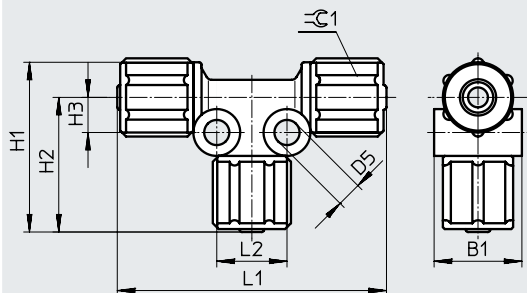

Ordering data

Pneumatic connection 1		Pneumatic connection 1		Nominal width	B1	D5	H1	H2	H3	L1	L2	$\pm C1$	Part no.	Type	PU ²⁾
For tubing O.D.	For barbed connector I.D. ¹⁾	For tubing O.D.	For barbed connector I.D. ¹⁾												
[mm]	[mm]	[mm]	[mm]	[mm]											
4	3	4	3	2.4	11	4.3	23.8	19.8	5	39.6	10	8	6273	FCK-3-PK-3-KU	10
6	4	6	4	3.4	15	4.3	30.2	24.2	6	48.4	12	12	6274	FCK-3-PK-4-KU	10
8	6	8	6	5.3	18	4.3	31.2	24.2	6	48.4	12	14	6275	FCK-3-PK-6-KU	10
-	9	-	9	8	22	4.3	38.3	28.8	7.1	56.4	13	19	6276	FCK-3-PK-9-KU	10

1) With union nut

2) Packaging unit

Datasheet

Union nut MCK

For tubing connectors

Union nut MCK...-KU

For tubing connectors



Operating and environmental conditions		MCK	MCK...-KU
Type			
Operating pressure for full temperature range	[MPa]	0 ... 1	
	[bar]	0 ... 10	
	[psi]	0 ... 145	
Operating medium		Compressed air to ISO 8573-1:2010 [7:::]	
Note on the operating/pilot medium		Lubricated operation possible	
Ambient temperature	[°C]	-10 ... +60	
Corrosion resistance class CRC ¹⁾		2 - Moderate corrosion stress	-

1) More information www.festo.com/x/topic/crc

Materials		MCK	MCK...-KU
Type			
Union nut material		Anodised wrought aluminium alloy	POM
Note on materials		RoHS-compliant	
LABS (PWIS) conformity		VDMA24364-B2-L	

Dimensions

Download CAD data → www.festo.com

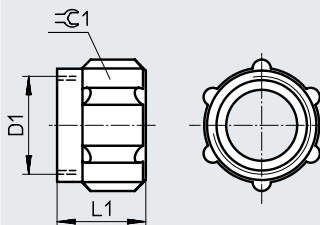

Ordering data		L1	=C1	Part no.	Type	PU ²⁾	
Size	Pneumatic connection						
Female thread	For tubing O.D.						
D1	[mm]	[mm]					
	For barbed connector I.D. ¹⁾						
	[mm]						
Aluminium design							
M6x0.75	4	3	8.5	8	205254	MCK-PK-3	1
M10x1	6	4	11	12	2965	MCK-PK-4 ³⁾	1
M8x1	6	4	9.5	-	205257	MCK-PK-4-R ⁴⁾	1
M12x1	8	6	11	14	2966	MCK-PK-6	1
M16x1	-	9	14.4	19	2967	MCK-PK-9	1
M22x1	-	13	18	24	206504	MCK-PK-13	1
Polymer design							
M6x0.75	4	3	9.5	8	211289	MCK-PK-3-KU	1
M10x1	6	4	12.5	12	211291	MCK-PK-4-KU ³⁾	1
M12x1	8	6	12.5	14	211292	MCK-PK-6-KU	1
M16x1	-	9	16	19	211293	MCK-PK-9-KU	1

1) With union nut

2) Packaging unit

3) Excluding connectors CK-M5-PK-4, LCK-M5-PK-4, TCK-M5-PK-4

4) For connectors CK-M5-PK-4, LCK-M5-PK-4, TCK-M5-PK-4

Datasheet

Hollow bolt VT with ring piece LK

Materials:
 Hollow bolt: Galvanised steel
 Ring piece LK: Die-cast zinc
 Ring piece LK...-KU: POM

Note on materials:
 RoHS-compliant

LABS (PWIS) conformity:
 VDMA24364-B1/B2-L

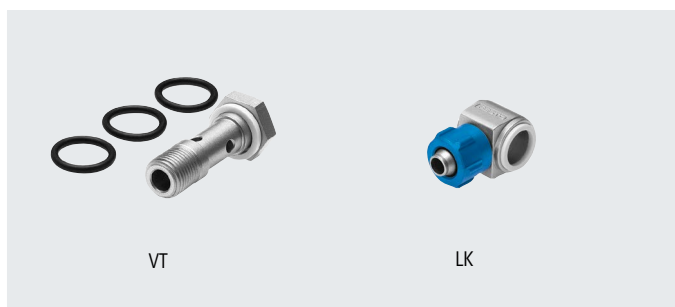

VT

LK

Operating and environmental conditions

Operating pressure for full temperature range [bar]	0 ... +10
Maritime classification	Ring piece LK: See certificate ¹⁾

1) More information www.festo.com/catalogue/lk → Support/Downloads.

Ordering data

Dimensions → 22

Hollow bolt				Ring piece				
Pneumatic connection 1	No. of ring pieces	Part no.	Type	Pneumatic connection 1	Pneumatic connection 2	Part no.	Type	PJ ¹⁾

Die-cast zinc design

Male thread M5	2	206145	VT-M5-2 ⁴⁾	Male thread M5	For barbed connector I.D. 3 mm with nut	4475	LK-M5-PK-3 ²⁾	10
	3	4594	VT-M5-3					
Male thread G1/8	2	4593	VT-1/8-2-PK-3	Male thread G1/8	For barbed connector I.D. 3 mm with nut	4597	LK-1/8-PK-3 ²⁾	10
	3	4595	VT-1/8-3-PK-3 ⁵⁾					
Male thread G1/8	2	206146	VT-1/8-2 ⁶⁾	Male thread G1/8	For barbed connector I.D. 4 mm with nut	4476	LK-1/8-PK-4 ²⁾	10
	3	4596	VT-1/8-3					
Male thread G1/8	2	206146	VT-1/8-2 ⁶⁾	Male thread G1/8	For barbed connector I.D. 6 mm with nut	4477	LK-1/8-PK-6 ²⁾	10
	3	4596	VT-1/8-3					
Male thread G1/4	2	206147	VT-1/4-2 ⁷⁾	Male thread G1/4	For barbed connector I.D. 4 mm with nut	4478	LK-1/4-PK-4 ²⁾	10
	3	2335	VT-1/4-3					
Male thread G1/4	2	206147	VT-1/4-2 ⁷⁾	Male thread G1/4	For barbed connector I.D. 6 mm with nut	4479	LK-1/4-PK-6 ²⁾	10
	3	2335	VT-1/4-3					
Male thread G3/8	2	206148	VT-3/8-2 ⁸⁾	Male thread G3/8	For barbed connector I.D. 6 mm with nut	4480	LK-3/8-PK-6 ²⁾	1
	3	2336	VT-3/8-3					

Polymer design

Male thread G1/8	2	206146	VT-1/8-2 ⁶⁾	Male thread G1/8	For barbed connector I.D. 4 mm with nut	6280	LK-1/8-PK-4-KU ³⁾	10
	3	4596	VT-1/8-3					
Male thread G1/8	2	206146	VT-1/8-2 ⁶⁾	Male thread G1/8	For barbed connector I.D. 6 mm with nut	6281	LK-1/8-PK-6-KU ³⁾	10
	3	4596	VT-1/8-3					
Male thread G1/4	2	206147	VT-1/4-2 ⁷⁾	Male thread G1/4	For barbed connector I.D. 4 mm with nut	6282	LK-1/4-PK-4-KU ³⁾	10
	3	2335	VT-1/4-3					
Male thread G1/4	2	206147	VT-1/4-2 ⁷⁾	Male thread G1/4	For barbed connector I.D. 6 mm with nut	6283	LK-1/4-PK-6-KU ³⁾	10
	3	2335	VT-1/4-3					

- 1) Packaging unit
- 2) With union nut MCK and 2 sealing rings OK
- 3) With union nut MCK, with moulded-on sealing edge, pressure range 0 ... 10 bar, temperature range -10 ... +60 °C
- 4) Pneumatic connection 2: for barbed connector I.D. 3 mm with nut
- 5) Pneumatic connection 2: for barbed connector I.D. 3 mm with nut
- 6) Pneumatic connection 2: female thread G1/8; for barbed connector I.D. 4 mm with nut; for barbed connector I.D. 6 mm with nut
- 7) Pneumatic connection 2: for barbed connector I.D. 4 mm with nut; for barbed connector I.D. 6 mm with nut
- 8) Pneumatic connection 2: for barbed connector I.D. 6 mm with nut

Datasheet

Hollow bolt VT with ring piece TK

Materials:
 Hollow bolt: Galvanised steel
 Ring piece TK: Die-cast zinc
 Ring piece TK...-KU: POM

Note on materials:
 RoHS-compliant

LABS (PWIS) conformity:
 VDMA24364-B1/B2-L

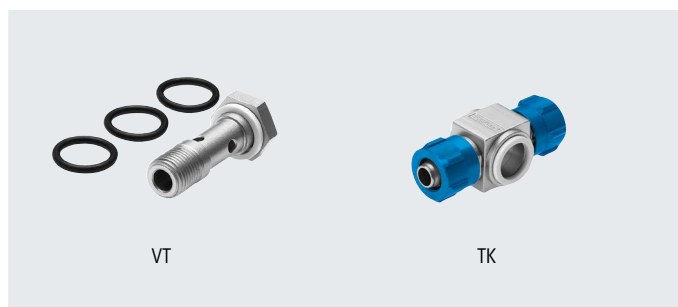

Operating and environmental conditions	
Operating pressure for full temperature range [bar]	0 ... +10
Operating medium	Compressed air to ISO 8573-1:2010 [7:-:-]
Note on the operating/pilot medium	Lubricated operation possible (in which case lubricated operation will always be required)
Maritime classification	Ring piece TK: See certificate ¹⁾

1) More information www.festo.com/catalogue/tk → Support/Downloads.

Ordering data				Dimensions → 22				
Hollow bolt				Ring piece				
Pneumatic connection 1	No. of ring pieces	Part no.	Type	Pneumatic connection 1	Pneumatic connection 2	Part no.	Type	PU ¹⁾
Die-cast zinc design								
Male thread M5	2	206145	VT-M5-2 ⁴⁾	Male thread M5	For barbed connector I.D. 3 mm with nut	4491	TK-M5-PK-3 ²⁾	1
	3	4594	VT-M5-3					
Male thread G1/8	2	4593	VT-1/8-2-PK-3	Male thread G1/8	For barbed connector I.D. 3 mm with nut	4598	TK-1/8-PK-3 ²⁾	1
	3	4595	VT-1/8-3-PK-3 ³⁾					
	2	206146	VT-1/8-2 ⁶⁾	Male thread G1/8	For barbed connector I.D. 4 mm with nut	4492	TK-1/8-PK-4 ²⁾	1
	3	4596	VT-1/8-3					
	2	206146	VT-1/8-2 ⁶⁾					
Male thread G1/4	3	4596	VT-1/8-3	Male thread G1/8	For barbed connector I.D. 6 mm with nut	4493	TK-1/8-PK-6 ²⁾	1
	2	206147	VT-1/4-2 ⁷⁾					
	3	2335	VT-1/4-3	Male thread G1/4	For barbed connector I.D. 4 mm with nut	4494	TK-1/4-PK-4 ²⁾	1
2	206147	VT-1/4-2 ⁷⁾						
Male thread G3/8	3	2335	VT-1/4-3	Male thread G1/4	For barbed connector I.D. 6 mm with nut	4495	TK-1/4-PK-6 ²⁾	1
	2	206148	VT-3/8-2 ⁸⁾					
Male thread G3/8	3	2336	VT-3/8-3	Male thread G3/8	For barbed connector I.D. 6 mm with nut	4496	TK-3/8-PK-6 ²⁾	1
	Polymer design							
Male thread G1/8	2	206146	VT-1/8-2 ⁶⁾	Male thread G1/8	For barbed connector I.D. 4 mm with nut	6284	TK-1/8-PK-4-KU ³⁾	1
	3	4596	VT-1/8-3					
	2	206146	VT-1/8-2 ⁶⁾	Male thread G1/8	For barbed connector I.D. 6 mm with nut	6285	TK-1/8-PK-6-KU ³⁾	1
	3	4596	VT-1/8-3					
Male thread G1/4	2	206147	VT-1/4-2 ⁷⁾	Male thread G1/4	For barbed connector I.D. 4 mm with nut	6286	TK-1/4-PK-4-KU ³⁾	1
	3	2335	VT-1/4-3					
	2	206147	VT-1/4-2 ⁷⁾	Male thread G1/4	For barbed connector I.D. 6 mm with nut	6287	TK-1/4-PK-6-KU ³⁾	1
	3	2335	VT-1/4-3					

- 1) Packaging unit
- 2) With 2 union nuts MCK and 2 sealing rings OK
- 3) With 2 union nuts MCK, with moulded-on sealing edge, pressure range 0 ... 10 bar, temperature range -10 ... +60 °C
- 4) Pneumatic connection 2: for barbed connector I.D. 3 mm with nut
- 5) Pneumatic connection 2: for barbed connector I.D. 3 mm with nut
- 6) Pneumatic connection 2: female thread G1/8; for barbed connector I.D. 4 mm with nut; for barbed connector I.D. 6 mm with nut
- 7) Pneumatic connection 2: for barbed connector I.D. 4 mm with nut; for barbed connector I.D. 6 mm with nut
- 8) Pneumatic connection 2: for barbed connector I.D. 6 mm with nut

Datasheet

Multiple distributor

Comprising:

- Hollow bolt VT and ring piece LK
→ 20

or

- Hollow bolt VT and ring piece TK
→ 21

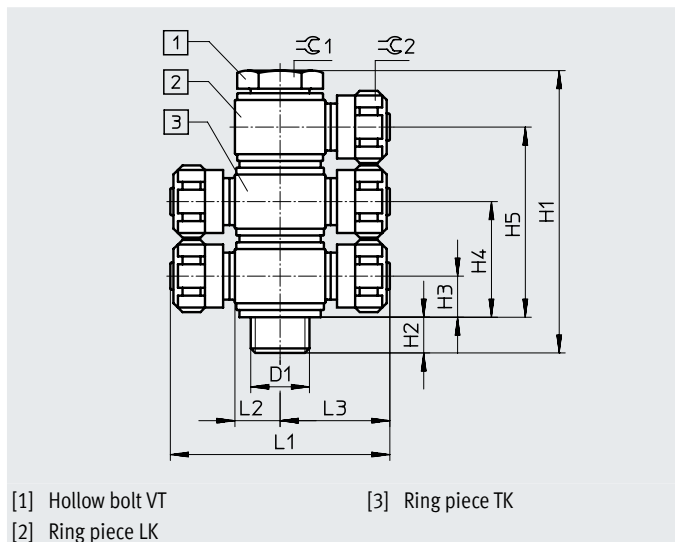

Dimensions														
Connection D1	Hollow bolt Type	Ring piece Type	H1	H2	H3	H4	H5	L1	L2	L3	≅1	≅2		
M5	VT-M5-2	LK-M5-PK-3	27.3	4	5.2	15.1	-	-	5	16.1	7	8		
		TK-M5-PK-3						32.2	-					
	VT-M5-3	LK-M5-PK-3	37.1	3.9	5.2	15.1	25	-	5	16.1	7	8		
		TK-M5-PK-3						32.2	-					
G1/8	VT-1/8-2-PK-3	LK-1/8-PK-3	32.7	5.9	6.1	16.7	-	-	8	19.1	13	8		
		TK-1/8-PK-3						38.2	-					
	VT-1/8-3-PK-3	LK-1/8-PK-3	43.3	5.9	6.1	16.7	27.3	-	8	19.1	13	8		
		TK-1/8-PK-3						38.2	-					
	VT-1/8-2	LK-1/8-PK-4	TK-1/8-PK-4	44.8	6	9.1	25.7	-	-	8	22.2	13	12	
									TK-1/8-PK-4	44.4				-
		LK-1/8-PK-6							-	8	22.3		14	
		TK-1/8-PK-6							44.6	-				
	VT-1/8-3	LK-1/8-PK-4	TK-1/8-PK-4	61.2	5.8	9.1	25.7	42.3	-	8	22.2	13		12
									TK-1/8-PK-4	44.4				
		LK-1/8-PK-6							-	8	22.3		14	
		TK-1/8-PK-6							44.6	-				
G1/4	VT-1/4-2	LK-1/4-PK-4	45.2	6.6	9.2	25.4	-	-	10	24.2	17	12		
								TK-1/4-PK-4	48.4					-
		LK-1/4-PK-6		6.2	9.3	25.7		-	10	24.3		14		
		TK-1/4-PK-6						48.6	-					
	VT-1/4-3	LK-1/4-PK-4	TK-1/4-PK-4	62.5	6.7	9.2	25.4	41.6	-	10	24.2		17	12
									TK-1/4-PK-4	48.4				
		LK-1/4-PK-6			6.1	9.3	25.7		42.1	-	10	24.3		14
		TK-1/4-PK-6								48.6	-			
G3/8	VT-3/8-2	LK-3/8-PK-6	47.5	7.5	9.3	25.7	-	-		12.5	26.8	22	14	
		TK-3/8-PK-6						53.6		-				
	VT-3/8-3	LK-3/8-PK-6	63.9	7.5	9.3	25.7		42.1	-	12.5	26.8		22	14
		TK-3/8-PK-6							53.6	-				