

Pressure sensor SDE5

FESTO



Characteristics

At a glance

The pressure sensor SDE5 is the cost-effective alternative for quick and easy pressure monitoring. This smart component instantly provides information about the actual pressure and is an equally effective device for object detection as it is for compressed air, regulation and vacuum detection. It can be used wherever simple sensing of the actual pressure is required:

- Compressed air monitoring
- Regulator monitoring
- Confirmation of suction in vacuum technology
- Object detection via back pressure
- Selectable output functions
- Teach-in function for programming
- Very short mounting times thanks to QS connections and wall brackets that can be linked
- Very quick switching-point adjustment by simply pressing a button
- Switching status indicated by an LED visible from all sides
- Relative pressure or differential pressure measurement
- 5 Pressure measuring ranges: 0 ... -1 bar, -1 ... 1 bar, 0 ... 2 bar, 0 ... 6 bar, 0 ... 10 bar
- Analogue output: 0 ... 10 V
- Electrical outputs: 1 switching output PNP or NPN

Product segmentation



Festo Core Range

Solves the majority of your automation tasks

With the Festo Core Range, we have selected the most important products and functions from our broad product catalogue, and added the quickest delivery. the Core Range offers you the best value with the expected high Festo quality.

- Quickest delivery, worldwide – wherever, whenever
- Expected high Festo quality
- Easy and fast to select

Ordering data - modular system

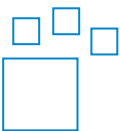

Configurable product

This product and all its product options can be ordered online via the configurator.

Type code

001 Series	
SDE5	Pressure sensor
002 Pressure measuring range	
V1	-1 ... 0 bar
B2	-1 ... 1 bar
D2	0 ... 2 bar
D6	0 ... 6 bar
D10	0 ... 10 bar
003 Pressure inlet	
	Relative pressure
Z	Differential pressure
004 Output function	
FP	Freely programmable, (switching/teach-in function, N/O contact, N/C contact)
O	Threshold value with fixed hysteresis, 1 teach-in point, N/O contact
C	Threshold value with fixed hysteresis, 1 teach-in point, N/C contact
O1	Threshold value with fixed hysteresis, 2 teach-in points, N/O contact
O2	Threshold value with variable hysteresis, N/O contact
O3	Window comparator with fixed hysteresis, N/O contact
C1	Threshold value with fixed hysteresis, 2 teach-in points, N/C contact
C2	Threshold value with variable hysteresis, N/C contact
C3	Window comparator with fixed hysteresis, N/C contact
NF	No binary switching function (analogue output)

005 Pneumatic connection	
T14E	Push-in fitting 1/4", at one end
M5	M5, on both sides
Q6	Push-in connector 6 mm, at both ends
Q4E	Push-in connector 4 mm, at one end
Q6E	Push-in connector 6 mm, at one end
M5E	M5, at one end
M7	M7, on both sides
M7E	M7, at one end
Q4	Push-in connector 4 mm, at both ends
S6E	Push-in sleeve 6 mm, at one end
S6Q	Push-in sleeve 6 mm
S8E	Push-in sleeve 8 mm, at one end
T14	Push-in connector 1/4", at both ends
T532	Push-in connector 5/32", at both ends
T532E	Push-in fitting 5/32", at one end

006 Electrical output 1	
N	NPN
P	PNP
V	0 ... 10 V

007 Electrical connection	
K	Open end
M8	Plug M8, 3-pin

Datasheet

General technical data

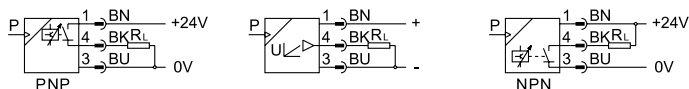

Pressure measuring range	-1 ... 0 bar	0 ... 2 bar	0 ... 10 bar
Pneumatic connection	QS-4, QS-6	QS-6	QS-4, QS-6, QS-1/4
Approval	RCM trademark, c UL us - Recognized (OL)		
CE mark (see declaration of conformity)	To EU EMC Directive, In accordance with EU RoHS Directive		
CE marking (see declaration of conformity)	To UK instructions for EMC, To UK RoHS instructions		
Note on materials	RoHS-compliant		
Measured variable	Relative pressure	Differential pressure, Relative pressure	
Measurement method	Piezoresistive pressure sensor		
Operating medium	Compressed air to ISO 8573-1:2010 [7:4:4]		
Media temperature	0 ... 50°C		
Ambient temperature	0 ... 50°C		
LABS (PWIS) conformity	VDMA24364-B1/B2-L		

Electrical data

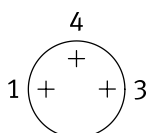

Pin allocation
Plug M8x1, 3-pin

1 Operating voltage +24V DC
4 Switching output or analogue output
3 0V

Pressure measuring range	-1 ... 0 bar	0 ... 2 bar	0 ... 10 bar
Electrical connection	3-wire, 3-pin, Cable, M8x1, Plugs, To EN 60947-5-2, Round design	3-wire, Cable, To EN 60947-5-2	3-wire, 3-pin, Cable, M8x1, Plugs, To EN 60947-5-2, Round design
Repetition accuracy in ± %FS	0.3		
Temperature coefficient in ± %FS/K	0.05 %FS/K		
Switching output	PNP		NPN, PNP
Switching function	Freely programmable, Threshold value with fixed hysteresis	Threshold value with fixed hysteresis	Window comparator, Freely programmable, Threshold value with fixed hysteresis, Threshold value with variable hysteresis
Switching element function	N/O contact, Switchable	N/O contact	N/C contact, N/O contact, Switchable
Max. output current	100 mA		
Voltage drop	-		
Inductive protective circuit	-		
Output characteristic curve start value	0	-	0
Output characteristic curve end value	10	-	10
Accuracy analogue output in ± %FS ¹⁾	3	-	3
Linearity error in ± %FS ²⁾	0.3	-	0.3
Short circuit current rating	yes		
Operational voltage range DC	15 ... 30 V		
Reverse polarity protection	For all electrical connections		

1) % FS = % of the measuring range end value (full scale)

2) % FS = % of the measuring range end value (full scale)

Datasheet

Mechanics

Pneumatic connection	QS-4	QS-4, QS-6, QS-5/32, QS-1/4	QS-6	QS-1/4
Type of mounting	With accessories			
Mounting position	optional			
Product weight	19 ... 47 g			19 g
Material housing	PA, POM			

Display/operation

Switching output	NPN, PNP			
Switching status indication	Yellow LED			
Setting range threshold value	0 ... 100%			
Analogue output	0 - 10 V			
Ready status indication	Green LED			

Immission/emission

Storage temperature	-			
Degree of protection	IP40			
Protection class	-			
Corrosion resistance class CRC ¹⁾	2 - Moderate corrosion stress			

1) More information www.festo.com/x/topic/crc

Dimensions

Dimensions – SDE5-...-M8, plug version/SDE5-...-K, cable version

Download CAD data → www.festo.com

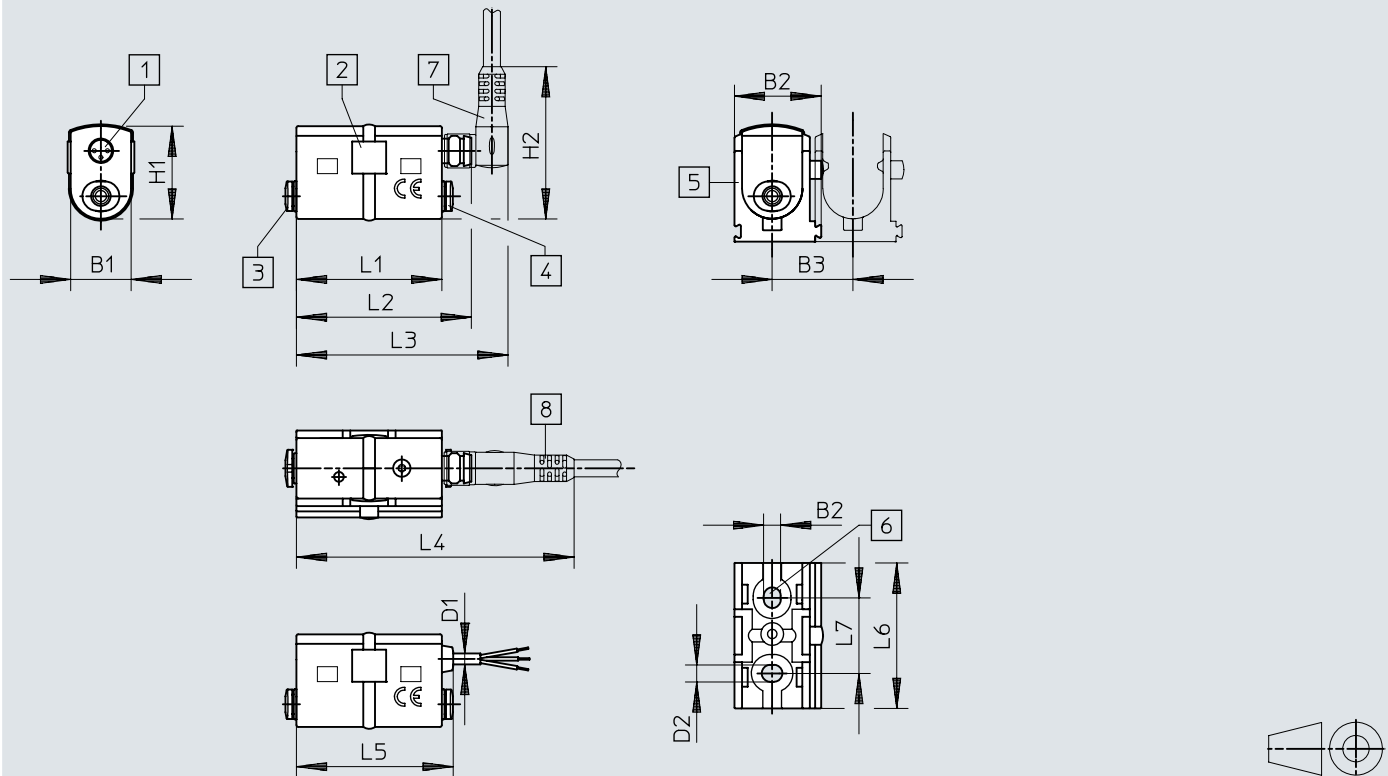

- [1] Plug M8x1, 3-pin or cable, 3-core, 2.5 m long
- [2] LED indicator, visible all around
- [3] Pneumatic connection 1
- [4] Pneumatic connection 2 or blanking plug for SDE5...E
- [5] Bracket for wall mounting (included in the scope of delivery)
- [6] 2x through hole for retaining screw
- [7] Connecting cable NEBU-M8W3 with angled socket
- [8] Connecting cable NEBU-M8G3 with straight socket

	B1	B2	B3	D1	D2	H1	H2	L1	L2	L3	L4	L5	L6	L7
SDE5-...-M8	16	23	21,4	–	4,5	24,5	40,3	38,5	45,5	56	73,5	–	38,5	20
SDE5-...-K				2,9			–		–	–	41,5			

Ordering data

Ordering data with plug M8						
	Pressure measuring range	Electrical connection	Pneumatic connection	Part no.	Type	
	-1 ... 0 bar	3-pin, M8x1, Plugs, To EN 60947-5-2, Round design	QS-4	★ 527460	SDE5-V1-0-Q4E-P-M8	
				★ 527457	SDE5-V1-0-Q4-P-M8	
			QS-6	567464	SDE5-V1-NF-Q6-V-M8	
				★ 527458	SDE5-V1-0-Q6-P-M8	
				★ 542886	SDE5-V1-01-Q6-P-M8	
				★ 542887	SDE5-V1-FP-Q6-P-M8	
				567463	SDE5-V1-NF-Q6E-V-M8	
				★ 527461	SDE5-V1-0-Q6E-P-M8	
			0 ... 10 bar	QS-4	★ 542900	SDE5-D10-FP-Q4E-P-M8
					★ 527466	SDE5-D10-0-Q4E-P-M8
					★ 542889	SDE5-D10-C-Q4E-P-M8
					★ 527463	SDE5-D10-0-Q4-P-M8
	QS-6	★ 542891			SDE5-D10-02-Q6E-P-M8	
		567465			SDE5-D10-NF-Q6E-V-M8	
		★ 542892		SDE5-D10-02-Q6-P-M8		
		★ 542898		SDE5-D10-FP-Q6-P-M8		
		567462		SDE5-D10Z-0-Q6-P-M8		
		★ 542894		SDE5-D10-C-Q6E-P-M8		
	QS-1/4	★ 542897		SDE5-D10-FP-Q6E-P-M8		
		567466		SDE5-D10-NF-Q6-V-M8		
		★ 527464	SDE5-D10-0-Q6-P-M8			
		★ 527467	SDE5-D10-0-Q6E-P-M8			
		567473	SDE5-D10-0-Q6-N-M8			
		567460	SDE5-D10Z-FP-Q6-P-M8			
	567468	SDE5-D10-0-T14E-P-M8				
	567467	SDE5-D10-FP-T14E-P-M8				

Ordering information with cable					
	Pressure measuring range	Electrical connection	Pneumatic connection	Part no.	Type
	-1 ... 0 bar	3-wire, Cable, To EN 60947-5-2	QS-6	567470	SDE5-V1-NF-Q6E-V-K
	0 ... 2 bar			★ 542888	SDE5-D2-0-Q6E-P-K
	0 ... 10 bar		QS-4	★ 542901	SDE5-D10-FP-Q4E-P-K
				QS-6	567469
			★ 542895		SDE5-D10-C-Q6E-P-K
			567471		SDE5-D10-NF-Q6E-V-K
			567472		SDE5-D10-NF-Q6-V-K
			★ 542896		SDE5-D10-C3-Q6E-P-K
			★ 542899		SDE5-D10-FP-Q6-P-K
			★ 542890		SDE5-D10-0-Q6E-P-K
			★ 542893		SDE5-D10-03-Q6E-P-K

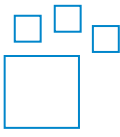
Ordering data – Modular product system			
	Pressure measuring range	Part no.	Type
	-1 ... 0 bar, -1 ... 1 bar, 0 ... 2 bar, 0 ... 6 bar, 0 ... 10 bar	529027	SDE5-

Peripherals

Peripherals overview

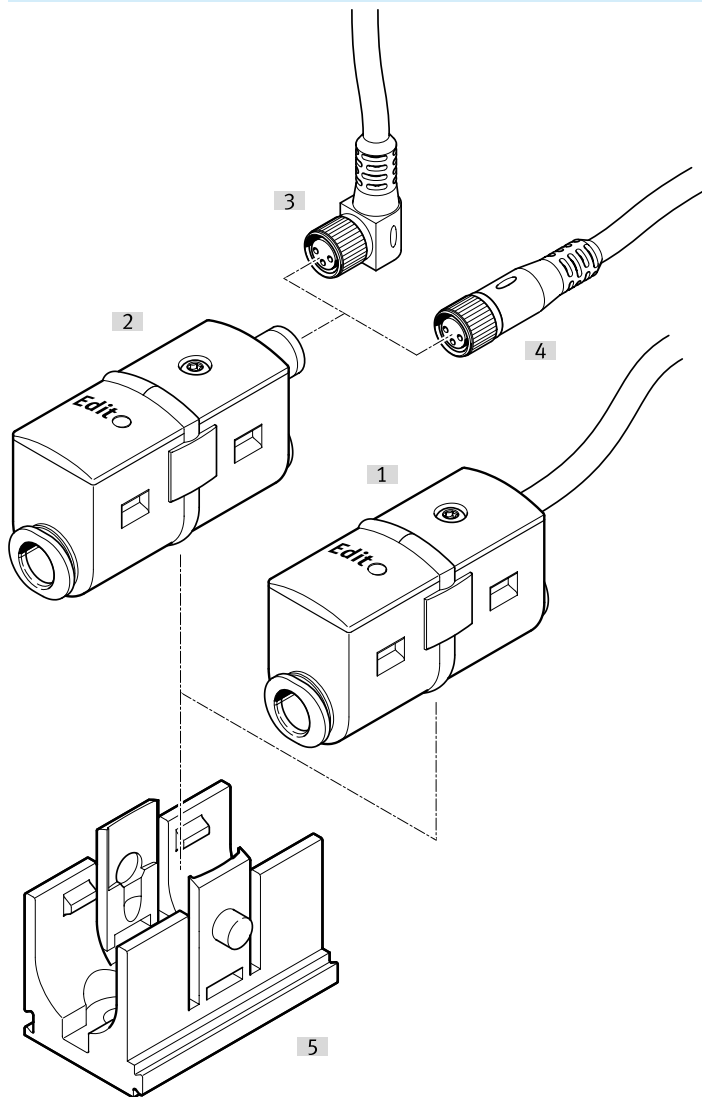

Accessories			→ Page/Internet
Type/order code	Description		
[1] Pressure sensor SDE5-...-K	Cable version		sde5
[2] Pressure sensor SDE5-...-M8	Plug version		sde5
[3] Connecting cable NEBU-M8W3	With angled plug socket		9
[4] Connecting cable NEBU-M8G3	With straight socket		9
[5] Wall bracket	(included in the scope of delivery)		-

Accessories

Connecting cable NEBU-M8x1, straight socket						
	Electrical connection 1, connector system	Cable structure	Cable length	Product weight	Part no.	Type
	M8x1, A-coded, to EN 61076-2-104	3 x 0.25 mm ²	2.5 m	64 g	541333	NEBU-M8G3-K-2.5-LE3
			5 m	123 g	541334	NEBU-M8G3-K-5-LE3

Connecting cable NEBU-M8x1, socket, angled						
	Electrical connection 1, connector system	Cable structure	Cable length	Product weight	Part no.	Type
	M8x1, A-coded, to EN 61076-2-104	3 x 0.25 mm ²	2.5 m	64 g	541338	NEBU-M8W3-K-2.5-LE3
			5 m	123 g	541341	NEBU-M8W3-K-5-LE3