

## Fieldbus modules CTEU/Installation system CTCL

**FESTO**

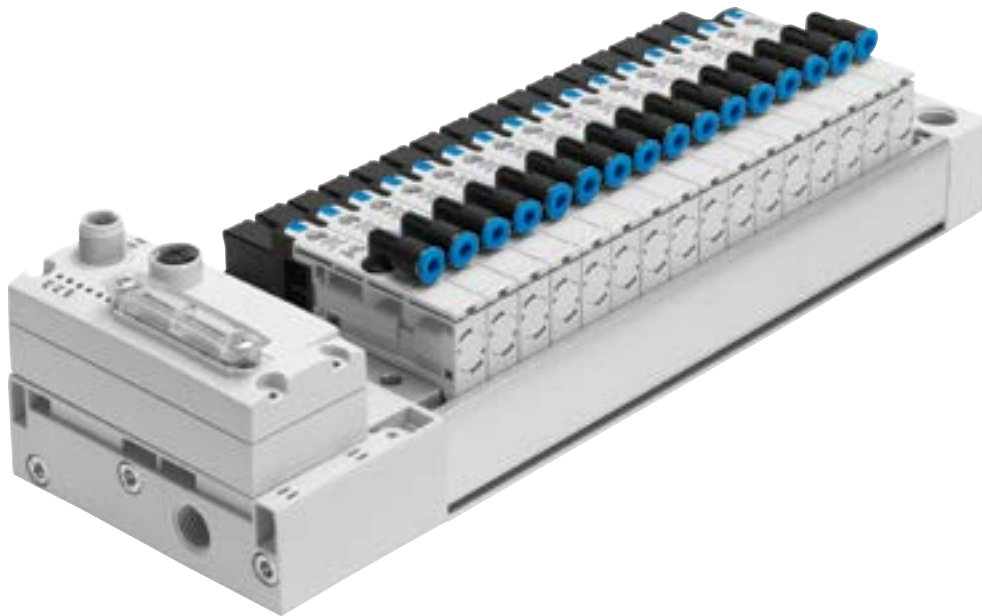

## Key features



### The system

- CTEU fieldbus modules for valve terminals
- Festo-specific interface (I-Port)
- Input modules CTSL for detecting sensor signals
- Connection for the installation system CPI from Festo
- Direct and easy networking of valve terminals and other devices via a bus connection
- Wide range of applications thanks to high degree of protection to IP65/67
- Universal connection technology (Sub-D, M12, terminal strip)
- Optional decentralised installation of the bus node for connecting two valve terminals
- Basic diagnostics: undervoltage, short circuit

CTEU for universal use of valve terminals. Thanks to the Festo-specific standardised definition of the interface (I-Port), the fieldbus modules can be used for different types of valve terminal.

The following protocols are currently supported:

- CANopen
- DeviceNet
- CC-Link
- PROFIBUS
- EtherCAT
- AS-Interface
- PROFINET
- EtherNet/IP
- VARAN
- Installation system CPI
- IO-Link

### Valve terminal configurator

Online at: → [www.festo.com](http://www.festo.com)

A valve terminal configurator is available online to help you select a suitable valve terminal.

Select a valve terminal with I-Port interface and order the relevant CTEU bus nodes. The bus nodes then only need to be placed on the valve terminal.

The ident. code for the valve terminals specifies the valve functions, the number of valves and vacant valve positions, as well as the additional functions and the type of compressed air supply.

As is the case with all Festo products, all valve terminals are supplied:

- Fully pre-assembled
- Equipped with fittings on request
- Tested for electrical function
- Tested for pneumatic function
- Securely packaged
- User documentation can be downloaded free of charge

## Key features

### Fieldbus systems with CTEU



#### CANopen

CANopen was originally developed for the automotive industry by a joint venture led by Bosch. It has been maintained by the organisation CiA (CAN in Automation) since 1995, and at the end of 2002 it was standardised as European standard EN 50325-4.



#### DeviceNet

DeviceNet is an open fieldbus standard that was developed by Rockwell Automation on the basis of the CAN protocol. DeviceNet is standardised in European standard EN 50325.



#### CC-Link

"Control and Communications Link" (CC-Link) was developed by Mitsubishi Electric and has been available as an open fieldbus network since 1999.



#### PROFIBUS

Process Fieldbus (PROFIBUS) is a fieldbus that was developed by Siemens and has been standardised in the IEC 61158 series of international standards. It enables communication between devices without the need for any specific adaptations to the interface.



#### EtherCAT

EtherCAT is a bus with real-time capability; it was developed by Beckhoff and the EtherCAT Technology Group (ETG). EtherCAT is an open technology and has been standardised in international standards IEC 61158 and IEC 61784 and in ISO 15745-4.



#### AS-Interface

AS-Interface is a manufacturer-independent, easy and sturdy installation system. It was developed and represented by the AS-International Association, a loose association of various companies from different sectors. AS-Interface has been standardised by IEC 62026-2 and EN 50295.



#### PROFINET

PROFINET by PROFIBUS and PROFINET International (PI) is the open industrial Ethernet standard for automation and is based on Ethernet TCP/IP and IT standards. PROFINET technology is developed by Siemens and the PROFIBUS user organisation. PROFINET is standardised in IEC 61158 and IEC 61784.



#### EtherNet/IP

EtherNet/IP was developed by Allen-Bradley (Rockwell Automation) and the ODVA (Open DeviceNet Vendor Association). EtherNet/IP is an open standard (technology based on Ethernet TCP/IP and UDP/IP) for industrial networks and is standardised in the IEC 61158 series of international standards.



#### VARAN

VARAN (Versatile Automation Random Access Network) is a real-time-capable Ethernet bus system that meets the highest requirements when it comes to flexibility and availability. It is an open bus system developed by Austrian company Sigmatek.

#### Installation system CPI

The CPI system is capable of meeting two completely contrasting requirements created by the difference between extensive decentralised modularisation and electrical installation.

All CP valve terminals and CP modules are connected using a ready-to-install CP cable, and routed to the CP interface. Every 4 modules make up an installation string that ends at the CP interface.



#### IO-Link

IO-Link consists of a central master and the IO-Link devices connected by special connecting cables. This permits a decentralised layout of the devices.

## Key features

### Integration of the I-Port interface/IO-Link

Different bus nodes are used for integration in the control systems of various manufacturers.

The following protocols are supported with the compatible bus node CTEU:

- CANopen
- DeviceNet
- EtherCAT
- CC-Link
- PROFIBUS
- AS-Interface
- PROFINET
- EtherNet/IP
- VARAN
- Installation system CPI
- IO-Link

A second valve terminal can be connected via an electrical connection block (decentralised adapter).  
(→ p.6)

### System overview, example

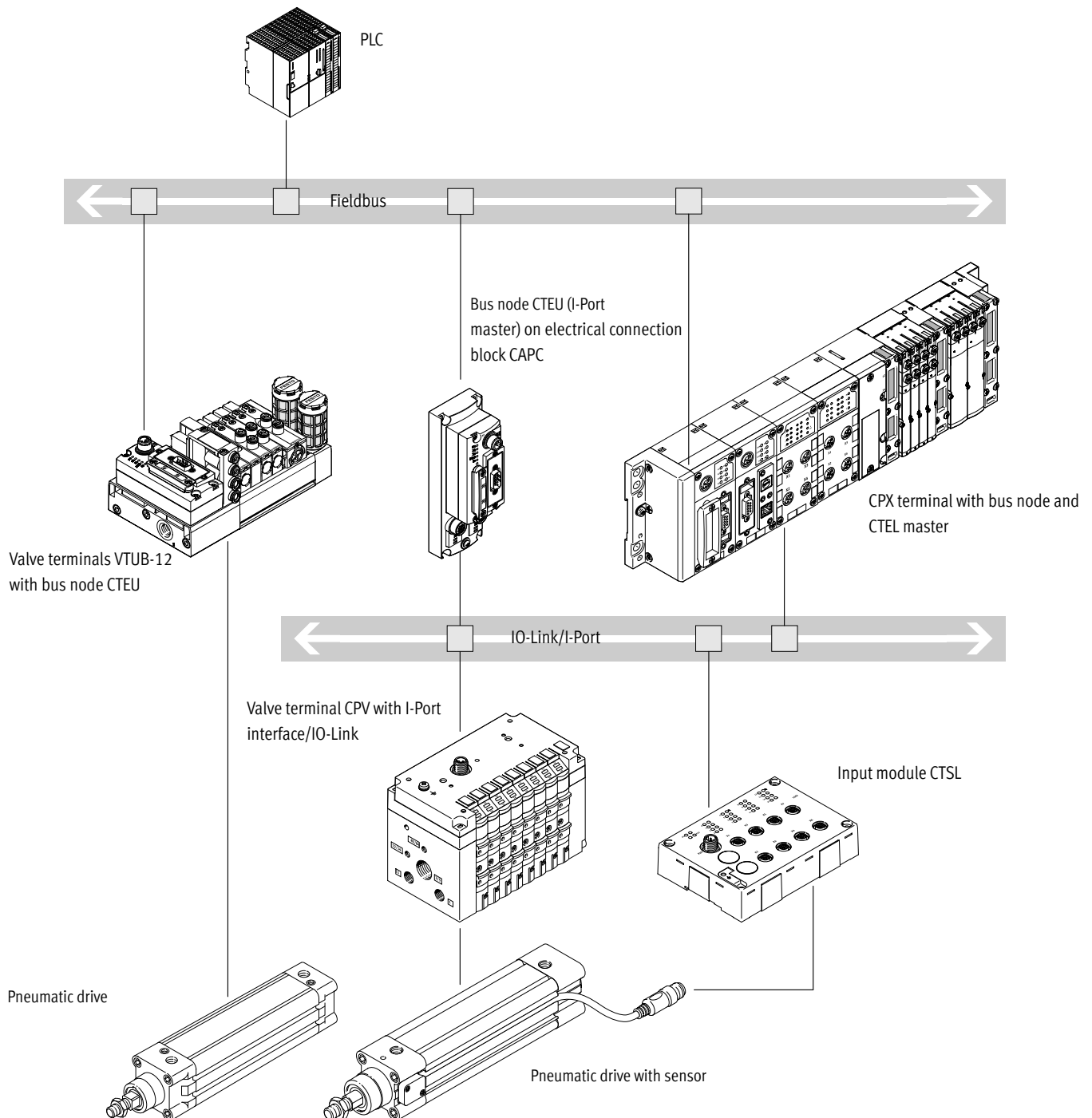

- Communication with the higher-order controller via fieldbus
- Use a bus node CTEU compatible with the fieldbus protocol
- Up to 64 inputs/outputs (solenoid coils), depending on the valve terminal

## Key features

### System overview

Example CTEU-AS interface

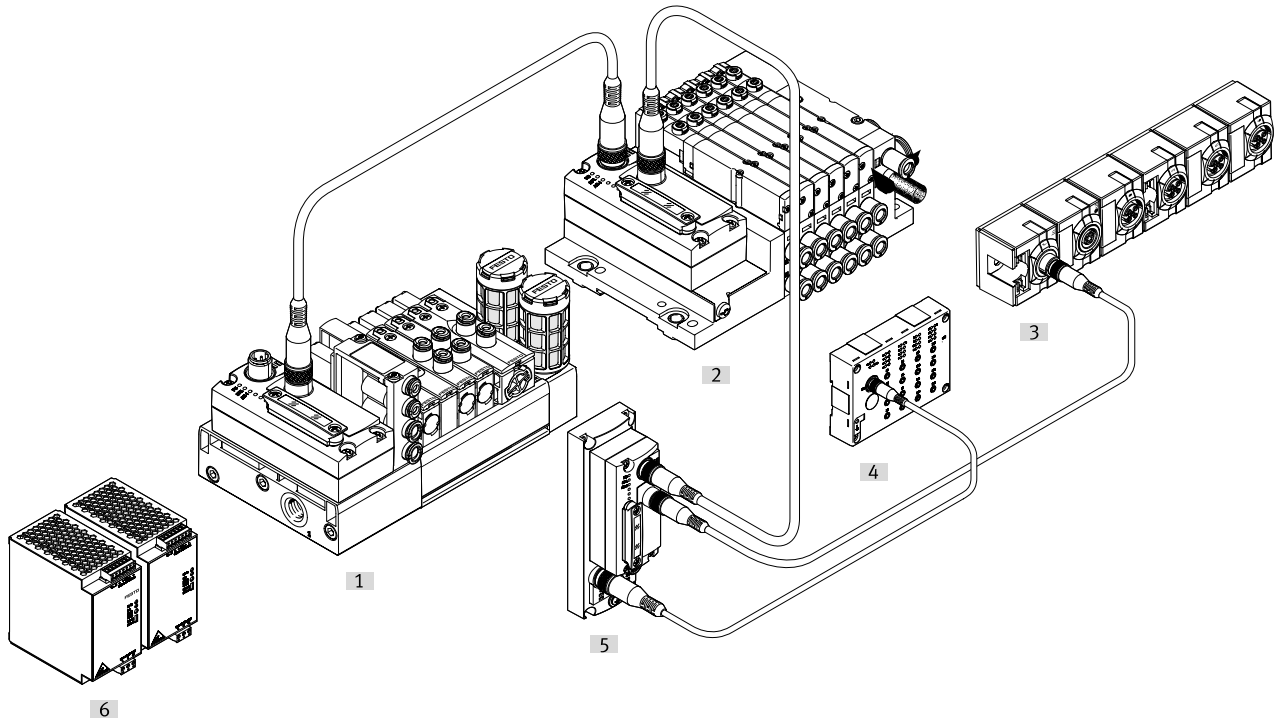

[1] AS-Interface gateway CESA  
[2] Valve terminal MPA-L with bus node CTEU-AS

[3] Compact AS-Interface I/O modules  
[4] Input module CTSL

[5] Electrical connection block CAPC, decentralised installation with bus node CTEU-AS

[6] Power supply unit CACN for AS-Interface systems

## Peripherals overview

### Overview of CTEU with valve terminal VTUG

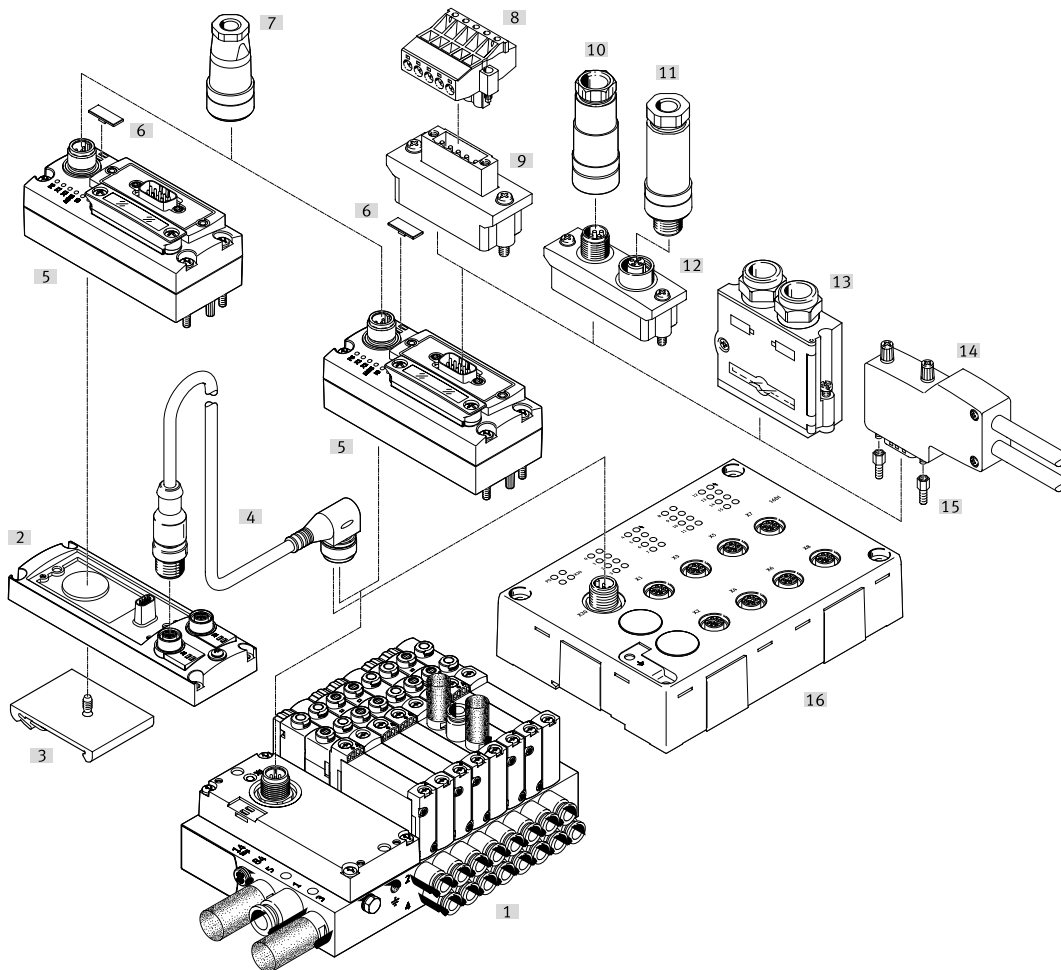

Accessories		Type	Brief description	→ Page/Internet
[1]	Manifold rail	VABM	With I-Port interface, for connecting max. 35 valves	vtug
[2]	Electrical connection block	CAPC	For connecting a further terminal (2x I-Port interface)	12
[3]	H-rail adapter	CAFM	For electrical connection block CAPC	13
[4]	Connecting cable	NEBU	For IO-Link	11, 13
[5]	Bus node	CTEU	–	14, 19, 24, 29, 35, 40, 44, 49, 53, 58
[6]	Inscription label	ASLR	For bus node	57
[7]	Power supply socket	NTSD/FBSD	For power supply	18, 23, 28, 33, 39, 48, 52, 57
[8]	Terminal strip	FBSD-KL	For open style connection	18, 23
[9]	Bus connection	FBA-1	Open style for 5-pin terminal strip	18, 23
[10]	Fieldbus socket	FBSD-GD, NECU	For micro style connection, M12, 5-pin	18, 23, 33
[11]	Plug	FBS, NECU	For micro style connection, M12, 5-pin	18, 23, 33
[12]	Bus connection	FBA-2	Micro style, 2xM12, 5-pin	18, 23, 33
[13]	Plug	FBS-SUB-9-BU	Sub-D	18, 23, 33
[14]	Plug	FBS-SUB-9-WS	Sub-D, angled	18, 33
[15]	Threaded sleeve	UNC	Sub-D mounting bolt	18, 23, 28, 33
[16]	Input module	CTSL-D-16E	–	85

## Key features – Diagnostics

### System diagnostics CTEU

#### Diagnostics LED on the bus node CTEU

The fieldbus-specific LEDs indicate the communication status and the fieldbus function.

A further LED indicates the status of the power supply:

- Undervoltage/short circuit
- Power supply ensured
- Interruption of voltage

#### Diagnostic messages via the fieldbus

- Configuration fault
- Short circuit/overload of an output module
- Short circuit/undervoltage
- Undervoltage/load voltage of the valves

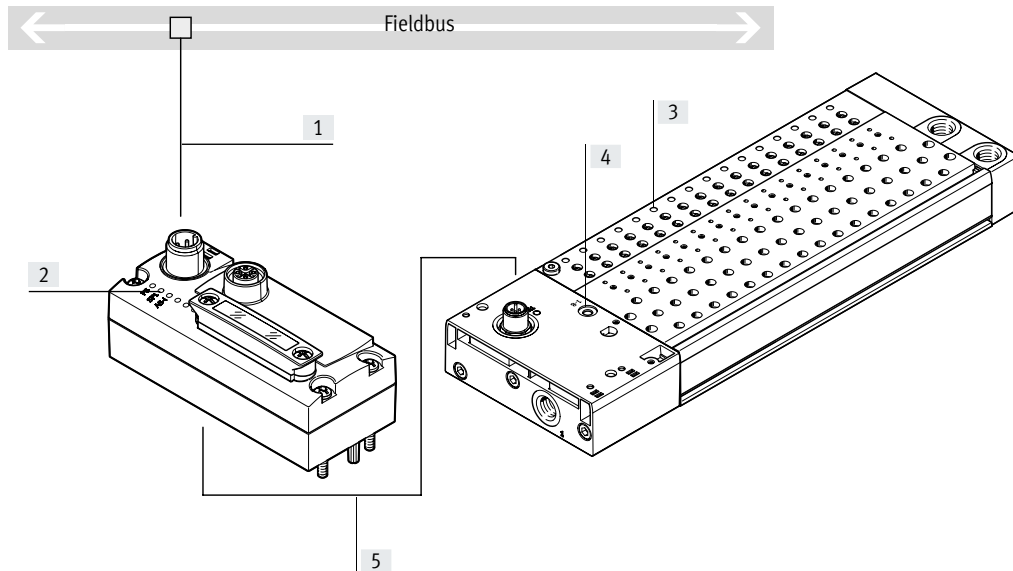

- [1] Diagnostics via fieldbus
- [2] Bus-specific LEDs
- [3] Switching status display using LEDs (one per valve on the manifold rail)
- [4] Additional communication and voltage status LED for decentralised installation
- [5] I-Port interface to the fieldbus module

## Key features – Power supply

### Operating voltage and load current supply

The operating voltages for the valve terminal with I-Port interface are centrally connected to the bus node via a 5-pin M12 plug.

The operating voltages are required for the bus node electronics and the load supply to the valves (supplied separately from the electronics supply).

The power supplies do not have a common 0 V line and are thus completely galvanically isolated from one another.

### Example power supply concept CTEU with valve terminal VTUG

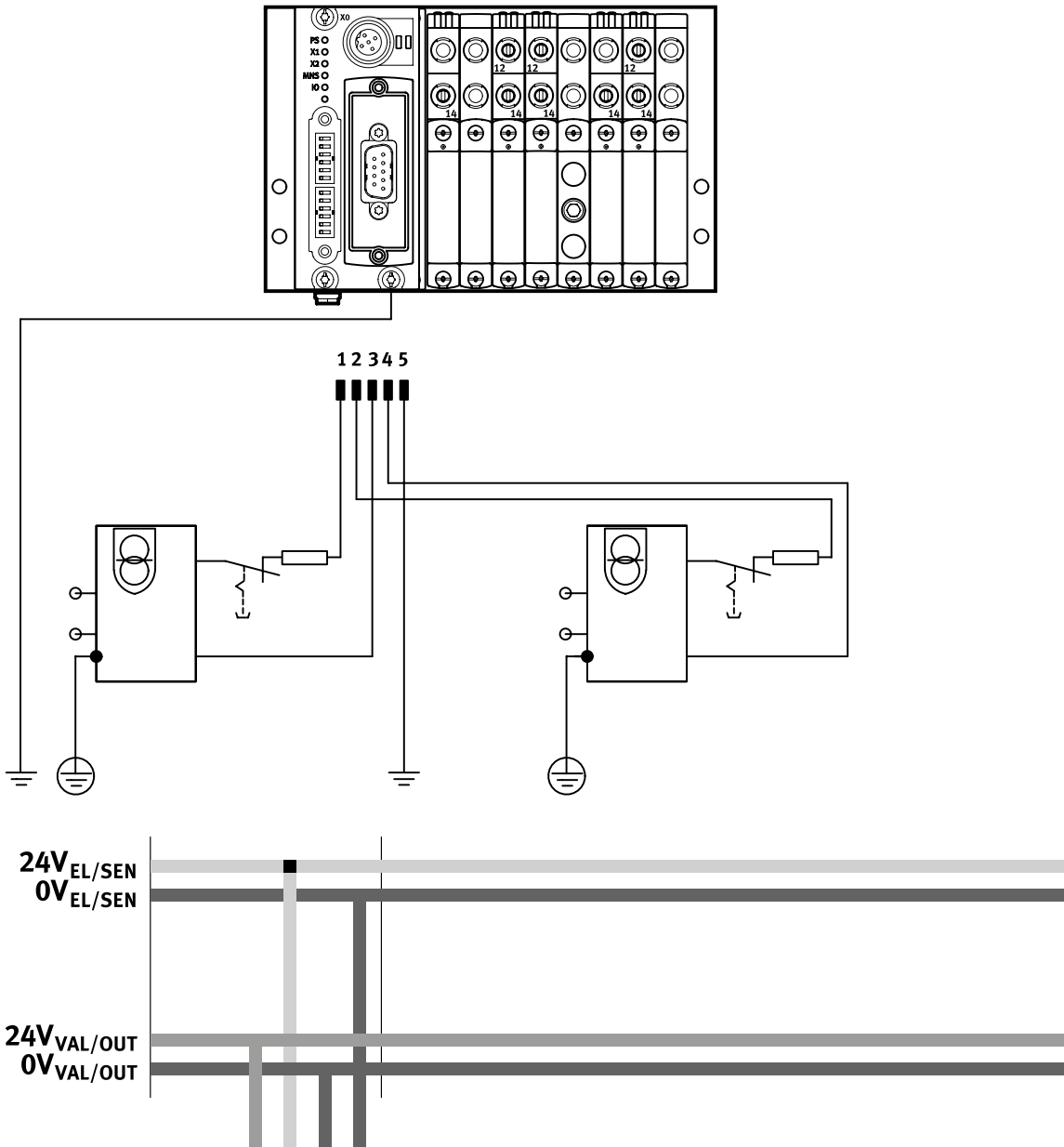



## Key features – Power supply

### Power supply concept

Example power supply concept CTEU with electrical connection block (decentralised adapter) CAPC and valve terminal VTUG

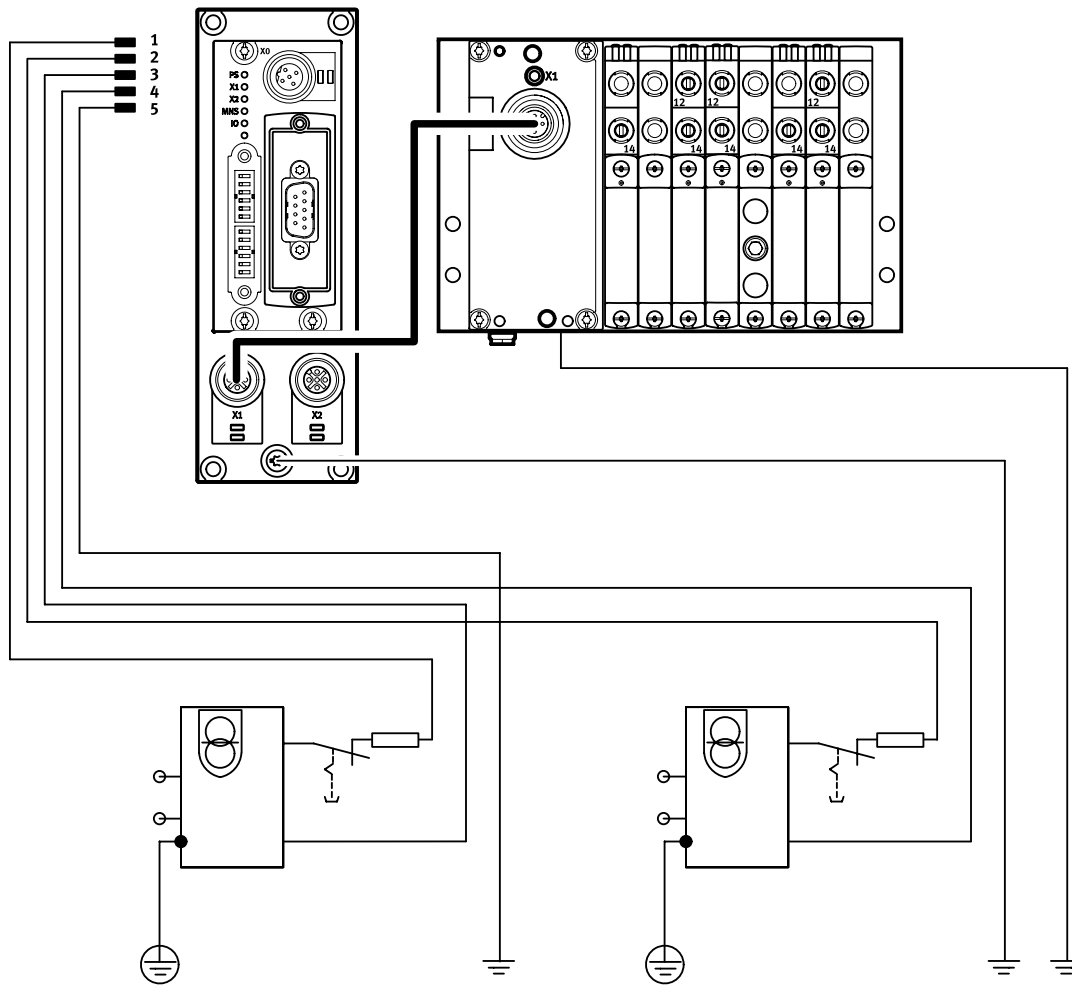

## Datasheet – I-Port interface/IO-Link for valve terminal VTUG

Festo-specific, standardised interface for direct connection to the fieldbus by mounting the bus node CTEU or to an IO-Link master via a cable (in IO-Link mode).



### I-Port interface/IO-Link

- Versions:
- I-Port interface for bus nodes (CTEU)
  - IO-Link mode for direct connection to a higher-level IO-Link master
- The electrical supply/transmission of communication takes place via an M12 plug.

#### General technical data

Types of communication	IO-Link		
Electrical connection	<ul style="list-style-type: none"> <li>M12 plug, 5-pin</li> <li>A-coded</li> <li>Metal thread for shielding</li> </ul>		
Baud rates	COM3	[kbps]	230.4
	COM2	[kbps]	38.4
Intrinsic current consumption, logic supply PS		[mA]	30
Intrinsic current consumption, valve supply PL		[mA]	30
Max. number of solenoid coils	VAEM-L1-S-8-PT		16
	VAEM-L1-S-16-PT		32
	VAEM-L1-S-24-PT		48
Max. no. of valve positions	VAEM-L1-S-8-PT		8
	VAEM-L1-S-16-PT		16
	VAEM-L1-S-24-PT		24
Ambient temperature		[°C]	-5 ... +50
Degree of protection to EN 60529	IP67		

#### LED indicator

	Colour	Status	Function
Status LED X1	Red/green	Off	No 24 V logic
	2	Status green	Everything OK
	3	Flashing green	Communication error (in the I-Port or IO-Link protocol)
	4	Flashing red/green	Load supply error (undervoltage or no load supply)
	5	Static red	Load supply error and communication error

#### Pin allocation – I-Port interface/IO-Link

	Pin	Allocation	Description
	1	24V <sub>EL/SEN</sub>	Operating voltage supply (electronics, sensors/inputs)
	2	24V <sub>VAL/OUT</sub>	Load voltage supply (valves/outputs)
	3	0V <sub>EL/SEN</sub>	Operating voltage supply (electronics, sensors/inputs)
	4	C/Q	Data communication
	5	0V <sub>VAL/OUT</sub>	Load voltage supply (valves/outputs)

## Datasheet – I-Port interface/IO-Link for valve terminal VTUG

## Dimensions

 Download CAD data → [www.festo.com](http://www.festo.com)

Outlet on top

Outlet on the side

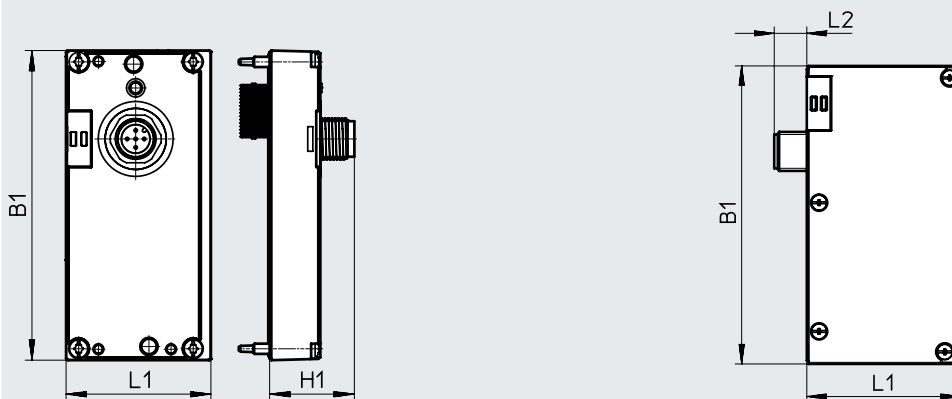

Type	Outlet on top			Outlet on the side		
	B1	L1	H1	B1	L1	L2
VAEM-L1-S-...	91	47.1	25	91.5	47.1	10

## Accessories – I-Port interface/IO-Link

	Description	Part no.	Type		
<b>Electrical interface for I-Port interface/IO-Link, outlet on top</b>					
	Actuation of up to 8 double solenoid valve positions	573384	VAEM-L1-S-8-PT		
	Actuation of up to 16 double solenoid valve positions	573939	VAEM-L1-S-16-PT		
	Actuation of up to 24 double solenoid valve positions	573940	VAEM-L1-S-24-PT		
<b>Electrical interface for I-Port interface/IO-Link, outlet on the side</b>					
	Actuation of up to 8 double solenoid valve positions	574207	VAEM-L1-S-8-PTL		
	Actuation of up to 16 double solenoid valve positions	574208	VAEM-L1-S-16-PTL		
	Actuation of up to 24 double solenoid valve positions	574209	VAEM-L1-S-24-PTL		
<b>Connection technology for IO-Link</b>					
	T-adapter M12, 5-pin for IO-Link and load supply	171175	FB-TA-M12-5POL		
<b>Straight plug, for I-Port/IO-Link</b>					
	Straight plug, M12, 5-pin (in combination with adapter for separate load supply)	175487	SEA-M12-5GS-PG7		
<b>Inscription label for I-Port/IO-Link</b>					
	40 pieces in frame	565306	ASLR-C-E4		
<b>Connecting cable</b>					
	Straight – angled	Suitable for energy chains	5 m	574321	NEBU-M12G5-E-5-Q8N-M12G5
			7.5 m	574322	NEBU-M12G5-E-7.5-Q8N-M12G5
			10 m	574323	NEBU-M12G5-E-10-Q8N-M12G5
	Angled – angled	Standard	0.5 m	570733	NEBU-M12W5-K-0.5-M12W5
				8003617	NEBU-M12G5-K-0.5-M12W5
			2 m	570734	NEBU-M12W5-K-2-M12W5
				8003618	NEBU-M12G5-K-2-M12W5

## Datasheet – Electrical connection block CAPC

### Function

The electrical connection block CAPC enables the decentralised installation of bus nodes CTEU on a valve terminal or input modules with I-Port interface.

### Area of application

- M12 connection technology (two interfaces)
- Enables the installation of valve terminals or other devices over a distance of 20 metres
- Accessory CAFM enables the connection block to be installed on an H-rail



### General technical data

Type		CAPC-F1-E-M12
Dimensions W x L x H	[mm]	50x148x28
Fieldbus interface		2 x M12 socket, 5-pin, A-coded
Operating voltage range	[V DC]	18 ... 30
Max. power supply	[A]	2
Nominal operating voltage	[V DC]	24
Product weight	[g]	85
Cable length	[m]	20

### Materials

Housing		Reinforced PA
Note on materials		RoHS-compliant

### Operating and environmental conditions

Degree of protection to EN 60529		IP65, IP67
Ambient temperature	[°C]	-5 ... +50
Storage temperature	[°C]	-20 ... +70
Corrosion resistance class CRC		2 <sup>1)</sup>
CE marking (see declaration of conformity)		To EU EMC Directive <sup>2)</sup>

1) Additional information: [www.festo.com/x/topic/kbk](http://www.festo.com/x/topic/kbk)

2) For information about the area of use, see the EC declaration of conformity at: [www.festo.com/catalogue/...](http://www.festo.com/catalogue/...) → Support/Downloads.

If the devices are subject to usage restrictions in residential, commercial or light-industrial environments, further measures for the reduction of the emitted interference may be necessary.

## Datasheet – Electrical connection block CAPC

## Dimensions

 Download CAD data → [www.festo.com](http://www.festo.com)

CAPC

CAPC with mounted bus node CTEU-CO

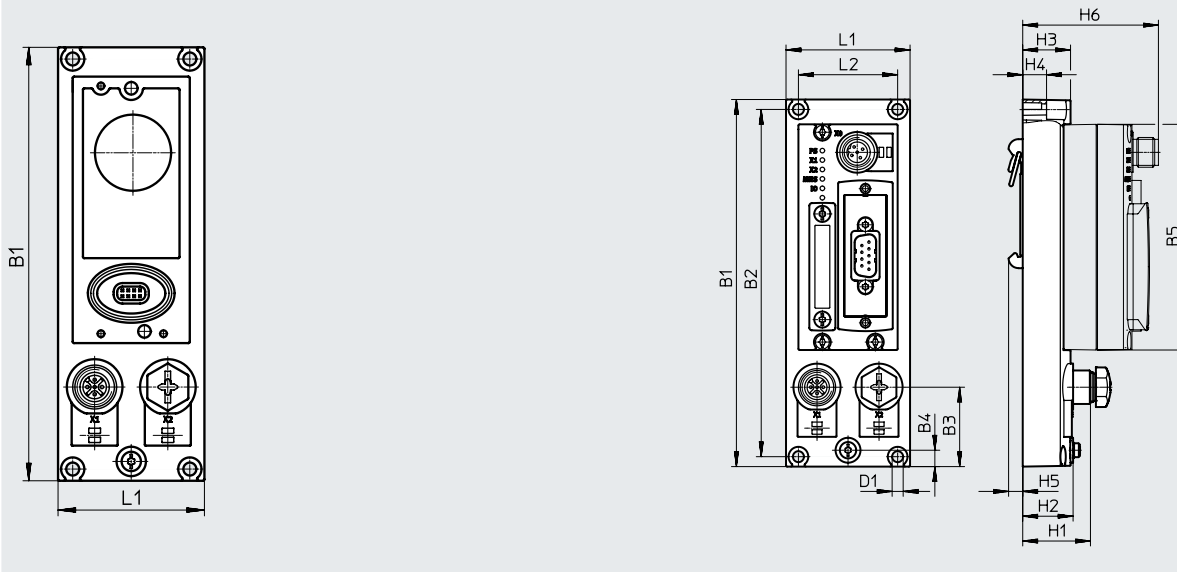

Type	B1	B2	B3	B4	B5	D1 ∅	H1	H2	H3	H4	H5	H6	L1	L2
CAPC	148	140	32	6.6	91	4.4	27.3	20.3	19.3	9.6	5.7	54.8	50	40

## Pin allocation – I-Port interface/IO-Link

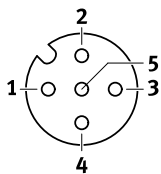

Pin	Allocation	Description
1	24V <sub>EL/SEN</sub>	Operating voltage supply (electronics, sensors/inputs)
2	24V <sub>VAL/OUT</sub>	Load voltage supply (valves/outputs)
3	0V <sub>EL/SEN</sub>	Operating voltage supply (electronics, sensors/inputs)
4	C/Q	Data communication
5	0V <sub>VAL/OUT</sub>	Load voltage supply (valves/outputs)
	Housing, FE	Functional earth

## Accessories CAPC

Description		Part no.	Type		
<b>Electrical connection block</b>					
	–	570042	CAPC-F1-E-M12		
<b>H-rail mounting</b>					
	–	570043	CAF-M-F1-H		
<b>Connecting cable</b>					
	Straight – angled	Suitable for energy chains	5	574321	NEBU-M12G5-E-5-Q8N-M12G5
			7.5	574322	NEBU-M12G5-E-7.5-Q8N-M12G5
			10	574323	NEBU-M12G5-E-10-Q8N-M12G5
	Angled – angled	Standard	0.5 m	570733	NEBU-M12W5-K-0.5-M12W5
				8003617	NEBU-M12G5-K-0.5-M12W5
				570734	NEBU-M12W5-K-2-M12W5
Straight – angled		2 m	8003618	NEBU-M12G5-K-2-M12W5	

Datasheet – CTEU-CO



The bus node handles communication between the valve terminal and a higher-order CANopen® master.

The module has basic diagnostic functions. It has 5 integrated LEDs for on-site display. A maximum of 8 byte inputs and 8 byte outputs are transmitted in the cyclic process image.



**Application**

Fieldbus connection

The bus connection is established via a 9-pin Sub-D plug as per the CAN in Automation (CiA) specification DS 102 with additional 24 V CAN transceiver supply (option as per DS 102).

The bus connector plug (with IP65/IP67 degree of protection from Festo or IP20 degree of protection from other manufacturers) facilitates the connection of an incoming and an outgoing bus cable.

There are 4 contacts available for each of the conductors (CAN\_L/CAN\_H and 24 V/0 V optional) of the incoming and outgoing bus cables.

The fieldbus parameters and the basic device parameter settings are set on the bus node via DIL switches.

**Implementation**

Protocol chip used:

- CAN transceiver 82C251

Possible transmission rate:

- 125 kbps
- 250 kbps
- 500 kbps
- 1 Mbps

Max. CANopen cable length (trunk cable):

- 40 m at 1 Mbps
- 100 m at 500 kbps
- 250 m at 250 kbps
- 500 m at 125 kbps

Max. branch cable length (drop cable):

- 0.30 m at 1 Mbps
- 0.75 m at 500 kbps
- 2.00 m at 250 kbps
- 3.75 m at 125 kbps

The following variants can be realised using an adapter:

- 2 x micro style M12, degree of protection IP65, 5-pin, plug and socket
- Open style plug, degree of protection IP20, 5-pin, pin

**General technical data**

**Fieldbus interface**

Protocol	CANopen
Function	Bus connection incoming/outgoing
Transmission rate	[kbps] 125, 250, 500 and 1000
Type	CAN Bus
Connection type	Plug
Connection technology	Sub-D
Number of pins/wires	9
Galvanic isolation	Yes
Internal cycle time	1 ms per 1 byte of user data
Note: Optional connection technology with accessories:	Micro style (plug/socket M12x1 A-coded, 5-pin, degree of protection IP65) Open style (terminal strip, 5-pin, degree of protection IP20) Open style (screw terminal, 5-pin, degree of protection IP20)

**Inputs/outputs**

Max. address volume inputs	[byte]	8
Note on inputs	[byte]	Expandable to max. 16
Max. address volume for outputs	[byte]	8
Note on outputs	[byte]	Expandable to max. 16

## Datasheet – CTEU-CO

General data		
Device-specific diagnostics	System diagnostics	
	Undervoltage	
	Communication error	
Parameterisation	Diagnostic behaviour	
	Fail-safe response	
Additional functions	Emergency message	
	Acyclic data access via SDO	
Configuration support	EDS files	
Control elements	DIL switches	
LED indicator	Product-specific	PS: Operating voltage for electronics and load supply
		X1: System status of module at I-Port 1
		X2: System status of module at I-Port 2
	Fieldbus-specific	MNS: Network status
		IO: I/O status

Technical data – Electrics		
Nominal operating voltage	[V DC]	24
Operating voltage range	[V DC]	18 ... 30
Intrinsic current consumption at nominal operating voltage	[mA]	Typically 65
Max. power supply	[A]	4
<b>Power supply</b>		
Function	Electronics and load	
Connection type	Plug	
Connection technology	M12x1, B-coded to EN 61076-2-101	
Number of pins/wires	5	

Technical data – Mechanical components		
Type of mounting	On electrical connection block	
	On electrical interface	
Product weight	[g]	90 (without fieldbus connector and without interlinking module)
Grid dimension	[mm]	40
Dimensions W x L x H	[mm]	40 x 91 x 50

Materials	
Housing	PA
Note on materials	RoHS-compliant
	Contains paint-wetting impairment substances

## Datasheet – CTEU-CO

Operating and environmental conditions		
Ambient temperature	[°C]	-5 ... +50
Storage temperature	[°C]	-20 ... +70
Corrosion resistance class CRC <sup>1)</sup>		2
CE marking (see declaration of conformity) <sup>3)</sup>		To EU EMC Directive <sup>2)</sup> To EU RoHS Directive
UKCA marking (see declaration of conformity) <sup>3)</sup>		To UK instructions for EMC <sup>2)</sup> To UK RoHS instructions
KC mark		KC EMC
Certification		c UL us - Listed (OL) RCM
Degree of protection		IP65/IP67
Note on degree of protection		In mounted state Unused connections sealed

1) Additional information: [www.festo.com/x/topic/kbk](http://www.festo.com/x/topic/kbk)

2) For information about the area of use, see the EC declaration of conformity at: [www.festo.com/catalogue/...](http://www.festo.com/catalogue/...) → Support/Downloads.

If the devices are subject to usage restrictions in residential, commercial or light-industrial environments, further measures for the reduction of the emitted interference may be necessary.

3) Additional information: [www.festo.com/catalogue/...](http://www.festo.com/catalogue/...) → Support/Downloads.

### Dimensions

Download CAD data → [www.festo.com](http://www.festo.com)

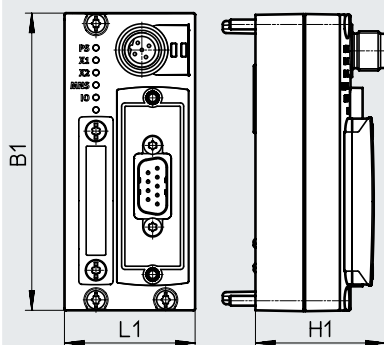

Type	B1	H1	L1
CTEU-CO	91	39.8	40

### Pin allocation





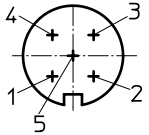
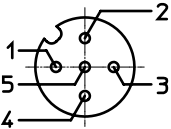
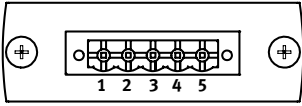
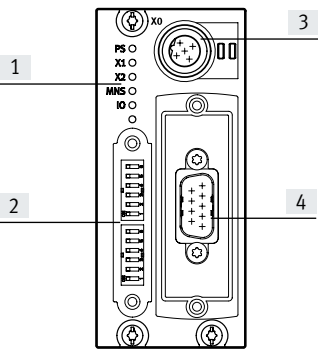

	Pin	Allocation	Description
<b>Sub-D, 9-pin, CANopen interface</b>			
	1	n.c.	Not connected
	2	CAN_L	Received/transmitted data low
	3	CAN_GND	0 V CAN interface (connected to pin 6)
	4	n.c.	Not connected
	5	CAN_Shld	Optional shielded connection
	6	GND	0 V CAN interface, optional (connected to pin 3)
	7	CAN_H	Received/transmitted data high
	8	n.c.	Not connected
	9	CAN_V+	24 V DC supply CAN interface
Housing			Cable shielding, connection to functional earth FE
<b>Power supply, M12, B-coded</b>			
	1	24V <sub>EL/SEN</sub>	Operating voltage supply (electronics, sensors/inputs)
	2	24V <sub>VAL/OUT</sub>	Load voltage supply (valves/outputs)
	3	0V <sub>EL/SEN</sub>	Operating voltage supply (electronics, sensors/inputs)
	4	0V <sub>VAL/OUT</sub>	Load voltage supply (valves/outputs)
	5	FE	Functional earth

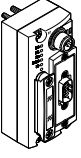
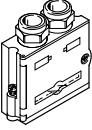
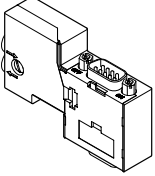
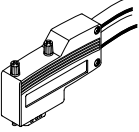
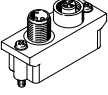

## Datasheet – CTEU-CO

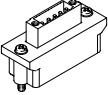
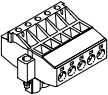
Pin allocation – CANopen interface			
	Pin	Allocation	Description
<b>Micro style bus connection (M12)</b>			
Incoming 	1	Shielding	Connection to FE (functional earth)
	2	CAN_V+	24 V DC supply CAN interface
	3	CAN_GND	0 V CAN interface
	4	CAN_H	Received/transmitted data high
	5	CAN_L	Received/transmitted data low
Outgoing 	1	Shielding	Connection to FE (functional earth)
	2	CAN_V+	24 V DC supply CAN interface
	3	CAN_GND	0 V CAN interface
	4	CAN_H	Received/transmitted data high
	5	CAN_L	Received/transmitted data low
<b>Open style bus connection</b>			
	1	CAN_GND	0 V CAN interface
	2	CAN_L	Received/transmitted data low
	3	Shielding	Connection to FE (functional earth)
	4	CAN_H	Received/transmitted data high
	5	CAN_V+	24 V DC supply CAN interface
<b>Connection and display components</b>			
	[1]	Status LED (operating status/diagnostics)	
	[2]	DIL switch	
	[3]	Power supply for bus node and connected devices (valve terminal)	
	[4]	Fieldbus interface (Sub-D plug)	

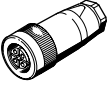
## Accessories – CTEU-CO

Ordering data		Part no.	Type	
<b>Bus node</b>				
	CANopen bus node	570038	CTEU-CO	
<b>Bus connection</b>				
	Sub-D socket, straight	532219	FBS-SUB-9-BU-2x5POL-B	
	Sub-D socket for CANopen with terminating resistor and programming interface	574588	NECU-S1W9-C2-ACO	
	Sub-D socket, angled	533783	FBS-SUB-9-WS-CO-K	
	Micro style bus connection, 2xM12, 5-pin, A-coded	525632	FBA-2-M12-5POL	
	Socket for micro style connection, A-coded	18324	FBSD-GD-9-5POL	
	Plug for micro style connection, M12, 5-pin, A-coded	175380	FBS-M12-5GS-PG9	
	Open style bus connection	525634	FBA-1-SL-5POL	
	Terminal strip for open style connection, 5-pin	525635	FBSD-KL-2x5POL	
<b>Fitting</b>				
	Threaded sleeve for Sub-D	533000	UNC4-40/M3X8	
<b>Plug socket</b>				
	For power supply	538999	NTSD-GD-9-M12-5POL-RK	
<b>User documentation</b>				
	User documentation – bus node CTEU-CO	German	573767	P.BE-CTEU-CO-OP+MAINT-DE
		English	573768	P.BE-CTEU-CO-OP+MAINT-EN
		Spanish	573769	P.BE-CTEU-CO-OP+MAINT-ES
		French	573770	P.BE-CTEU-CO-OP+MAINT-FR
		Italian	573771	P.BE-CTEU-CO-OP+MAINT-IT
		Chinese	573772	P.BE-CTEU-CO-OP+MAINT-ZH

## Datasheet – CTEU-DN



The bus node handles communication between the valve terminal and a higher-order DeviceNet® master.

The module has basic diagnostic functions. It has 5 integrated LEDs for on-site display. Up to 8 byte inputs and 8 byte outputs are typically transmitted in the cyclic process image.

**Application**
**Fieldbus connection**

The bus connection is established via a 9-pin Sub-D plug with a typical allocation (to EN 50170).

The bus connector plug (with degree of protection IP65/IP67 from Festo or degree of protection IP20 from other manufacturers) facilitates the connection of an

incoming and an outgoing bus cable. The fieldbus parameters and the basic device parameter settings are

set on the bus node via DIL switches.

**Implementation**
**Protocol chip used:**

- CAN transceiver 82C251

**Possible transmission rate:**

- 125 kbps
- 250 kbps
- 500 kbps

**Max. DeviceNet cable length (trunk cable):**

- 100 m at 500 kbps
- 250 m at 250 kbps
- 500 m at 125 kbps

**Max. branch cable length (drop cable):**

- 6 m at 500 kbps
- 6 m at 250 kbps
- 6 m at 125 kbps

The following variants can be realised using an adapter:

- 2 x micro style M12, degree of protection IP65, 5-pin, plug and socket
- Open style plug, degree of protection IP20, 5-pin, pin

**General technical data**
**Fieldbus interface**

Protocol	DeviceNet
Transmission rate [kbps]	125, 250, 500
Type	CAN Bus
Connection type	Plug
Connection technology	Sub-D
Number of pins/wires	9
Galvanic isolation	Yes
Internal cycle time	1 ms per 1 byte of user data
Note: Optional connection technology with accessories:	Micro style (plug/socket M12x1 A-coded, 5-pin, degree of protection IP65)
	Open style (terminal strip, 5-pin, degree of protection IP20)
	Open style (screw terminal, 5-pin, degree of protection IP20)

**Inputs/outputs**

Max. address volume inputs [byte]	8
Max. address volume for outputs [byte]	8

## Datasheet – CTEU-DN

General data		
Device-specific diagnostics		System diagnostics
		Undervoltage
		Communication error
Parameterisation		Diagnostic behaviour
		Fail-safe and idle response
Additional functions		Acyclic data access via "Explicit Message"
		QuickConnect
		System status can be displayed using process data
Configuration support		EDS files
Control elements		DIL switches
LED indicator	Product-specific	PS: Operating voltage for electronics and load supply
		X1: System status of module at I-Port 1
		X2: System status of module at I-Port 2
	Fieldbus-specific	MNS: Network status
		IO: I/O status

Technical data – Electrics		
Nominal operating voltage	[V DC]	24
Operating voltage range	[V DC]	18 ... 30
Intrinsic current consumption at nominal operating voltage	[mA]	Typically 65
Max. power supply	[A]	4
<b>Power supply</b>		
Function		Electronics and load
Connection type		Plug
Connection technology		M12x1, B-coded to EN 61076-2-101
Number of pins/wires		5

Technical data – Mechanical components		
Type of mounting		On electrical connection block
		On electrical interface
Product weight	[g]	90 (without fieldbus connector and without interlinking module)
Grid dimension	[mm]	40
Dimensions W x L x H	[mm]	40 x 91 x 50

Materials		
Housing		PA, PC
Note on materials		RoHS-compliant
		Contains paint-wetting impairment substances

## Datasheet – CTEU-DN

Operating and environmental conditions		
Ambient temperature	[°C]	-5 ... +50
Storage temperature	[°C]	-20 ... +70
Corrosion resistance class CRC <sup>1)</sup>		2
CE marking (see declaration of conformity) <sup>3)</sup>		To EU EMC Directive <sup>2)</sup>
		To EU RoHS Directive
UKCA marking (see declaration of conformity) <sup>3)</sup>		To UK instructions for EMC <sup>2)</sup>
		To UK RoHS instructions
KC mark		KC EMC
Certification		c UL us - Listed (OL)
		RCM
Degree of protection		IP65/IP67
Note on degree of protection		In mounted state
		Unused connections sealed

1) Additional information: [www.festo.com/x/topic/kbk](http://www.festo.com/x/topic/kbk)

2) For information about the area of use, see the EC declaration of conformity at: [www.festo.com/catalogue/...](http://www.festo.com/catalogue/...) → Support/Downloads.

If the devices are subject to usage restrictions in residential, commercial or light-industrial environments, further measures for the reduction of the emitted interference may be necessary.

3) Additional information: [www.festo.com/catalogue/...](http://www.festo.com/catalogue/...) → Support/Downloads.

## Dimensions

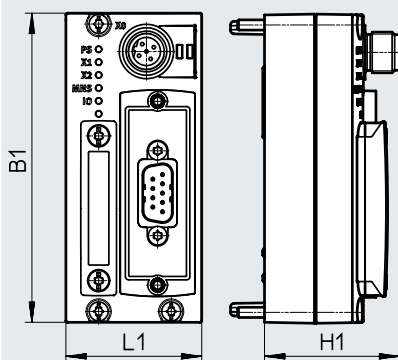
 Download CAD data → [www.festo.com](http://www.festo.com)

Type	B1	H1	L1
CTEU-DN	91	39.8	40





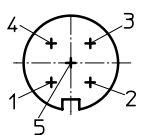
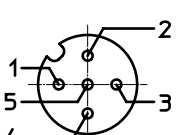
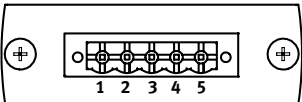
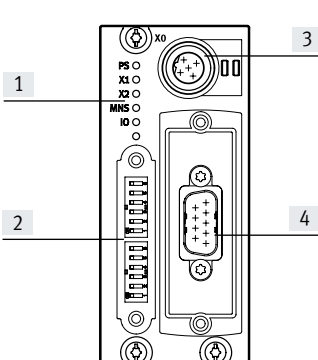

## Pin allocation

	Pin	Allocation	Description
<b>Sub-D, 9-pin, DeviceNet interface</b>			
<p>The diagram shows a 9-pin Sub-D connector with pins numbered 1 to 9. Pins 1, 2, 3, 4, 5, 6, 7, 8, and 9 are arranged in a vertical line. Pins 1, 2, 3, 4, 5, 6, 7, 8, and 9 are marked with '+' signs.</p>	1	n.c.	Not connected
	2	CAN_L	Received/transmitted data low
	3	CAN_GND	0 V CAN interface (connected to pin 6)
	4	n.c.	Not connected
	5	CAN_Shld	Optional shielded connection
	6	GND	0 V CAN interface, optional (connected to pin 3)
	7	CAN_H	Received/transmitted data high
	8	n.c.	Not connected
	9	CAN_V+	24 V DC supply CAN interface
Housing		Cable shielding, connection to functional earth FE	
<b>Power supply, M12, B-coded</b>			
<p>The diagram shows an M12 B-coded power supply connector with pins numbered 1 to 5. Pins 1, 2, 3, 4, and 5 are arranged in a circle. Pins 1, 2, 3, 4, and 5 are marked with '+' signs.</p>	1	24V <sub>EL/SEN</sub>	Operating voltage supply (electronics, sensors/inputs)
	2	24V <sub>VAL/OUT</sub>	Load voltage supply (valves/outputs)
	3	0V <sub>EL/SEN</sub>	Operating voltage supply (electronics, sensors/inputs)
	4	0V <sub>VAL/OUT</sub>	Load voltage supply (valves/outputs)
	5	FE	Functional earth

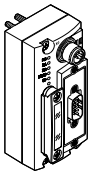
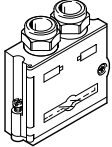
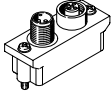
Datasheet – CTEU-DN

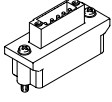
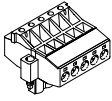
Pin allocation			
	Pin	Allocation	Description
<b>Micro style bus connection (M12)</b>			
Incoming 	1	Shielding	Connection to FE (functional earth)
	2	CAN_V+	24 V DC supply CAN interface
	3	CAN_GND	0 V CAN interface
	4	CAN_H	Received/transmitted data high
	5	CAN_L	Received/transmitted data low
Outgoing 	1	Shielding	Connection to FE (functional earth)
	2	CAN_V+	24 V DC supply CAN interface
	3	CAN_GND	0 V CAN interface
	4	CAN_H	Received/transmitted data high
	5	CAN_L	Received/transmitted data low
<b>Open style bus connection</b>			
	1	CAN_GND	0 V CAN interface
	2	CAN_L	Received/transmitted data low
	3	Shielding	Connection to FE (functional earth)
	4	CAN_H	Received/transmitted data high
	5	CAN_V+	24 V DC supply CAN interface
<b>Connection and display components</b>			
	[1]	Status LED (operating status/diagnostics)	
	[2]	DIL switch	
	[3]	Power supply for bus node and connected devices (valve terminal)	
	[4]	Fieldbus interface (Sub-D plug)	

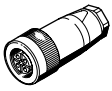
## Accessories – CTEU-DN

Ordering data		Part no.	Type	
<b>Bus node</b>				
	DeviceNet bus node	570039	CTEU-DN	
<b>Bus connection</b>				
	Sub-D socket, straight	532219	FBS-SUB-9-BU-2x5POL-B	
	Micro style bus connection, 2xM12, 5-pin, A-coded	525632	FBA-2-M12-5POL	
	Socket for micro style connection, M12, 5-pin	18324	FBSD-GD-9-5POL	
	Plug for micro style connection, M12, 5-pin	175380	FBS-M12-5GS-PG9	
	Open style bus connection	525634	FBA-1-SL-5POL	
	Terminal strip for open style connection, 5-pin	525635	FBSD-KL-2x5POL	
<b>Fitting</b>				
	Threaded sleeve for Sub-D	533000	UNC4-40/M3X8	
<b>Plug socket</b>				
	For power supply	538999	NTSD-GD-9-M12-5POL-RK	
<b>User documentation</b>				
	User documentation – bus node CTEU-DN	German	573744	P.BE-CTEU-DN-OP+MAINT-EN
		English	573745	P.BE-CTEU-DN-OP+MAINT-EN
		Spanish	573746	P.BE-CTEU-DN-OP+MAINT-ES
		French	573747	P.BE-CTEU-DN-OP+MAINT-FR
		Italian	573748	P.BE-CTEU-DN-OP+MAINT-IT
		Chinese	573779	P.BE-CTEU-DN-OP+MAINT-ZH

## Datasheet – CTEU-CC



The bus node handles communication between the valve terminal and a higher-order master for Control & Communication Link (CC-Link®).

The module has basic diagnostic functions. It has 5 integrated LEDs for on-site display. A maximum of 8 byte inputs and 8 byte outputs are transmitted in the cyclic process image.



### Application

#### Fieldbus connection

The bus connection is established via a screw terminal with degree of protection IP20, a 9-pin Sub-D socket with degree of protection IP65/IP67 from Festo or a Sub-D socket with degree of protection IP20 from other manufacturers.

The module has a system and load supply, a fieldbus connection and a connection to the valve terminal with serial I-Port interface.

Both connection types have the function of an integrated T-distributor and thus support the connection of an incoming and outgoing bus cable.

The integrated interface with RS485 transmission technology is designed for the typical CC-Link 3-wire connection technology (in accordance with CLPA CC-Link Spec. V1.1).

### Implementation

Protocol chip used:

- MFP3 from Mitsubishi

Maximum CC-Link cable length (minimum 0.2 m between devices):

- 100 m at 10 Mbps
- 150 m at 5 Mbps
- 200 m at 2.5 Mbps
- 600 m at 625 kbps
- 1200 m at 156 kbps

When using branch lines: maximum branch line length 8 m, maximum 6 stations per branch line

Length of main string:

- 100 m at 625 kbps, total length of branch line 50 m
- 500 m at 156 kbps, total length of branch line 200 m

Higher baud rates not permitted with a branch line.

The following variant can be realised using an adapter:

- Spring-loaded terminal with degree of protection IP65

### General technical data

#### Fieldbus interface

Protocol		CC-Link
Function		Bus connection incoming/outgoing
Transmission rate	[kbps]	156 ... 10000
Type		Serial interface
Connection type		Socket
Connection technology		Sub-D
Number of pins/wires		9
Galvanic isolation		Yes
Internal cycle time		1 ms per 1 byte of user data
Note: Optional connection technology with accessories:		Open style (screw terminal, 5-pin, degree of protection IP20)
<b>Inputs/outputs</b>		
Max. address volume inputs	[byte]	16
Max. address volume for outputs	[byte]	16



## Datasheet – CTEU-CC

General data		
Device-specific diagnostics		System diagnostics
		Undervoltage
		Communication error
Parameterisation		Activating diagnostics
		Fail-safe and idle response
Additional functions		System status can be displayed using process data
Control elements		DIL switches
LED indicator	Product-specific	PS: Operating voltage for electronics and load supply
		X1: System status of module at I-Port 1
	Fieldbus-specific	X2: System status of module at I-Port 2
		Err: Data transmission error
	Run: Bus active	
Technical data – Electrics		
Nominal operating voltage	[V DC]	24
Operating voltage range	[V DC]	18 ... 30
Intrinsic current consumption at nominal operating voltage	[mA]	Typically 70
Max. power supply	[A]	4
Power supply		
Function		Electronics and load
Connection type		Plug
Connection technology		M12x1, A-coded to EN 61076-2-101
Number of pins/wires		5
Technical data – Mechanical components		
Type of mounting		On electrical connection block
		On electrical interface
Product weight	[g]	90 (without fieldbus connector and without interlinking module)
Grid dimension	[mm]	40
Dimensions W x L x H	[mm]	40 x 91 x 50
Materials		
Housing		PA
Note on materials		RoHS-compliant
		Contains paint-wetting impairment substances

## Datasheet – CTEU-CC

Operating and environmental conditions		
Ambient temperature	[°C]	-5 ... +50
Storage temperature	[°C]	-20 ... +70
Corrosion resistance class CRC <sup>1)</sup>		2
CE marking (see declaration of conformity) <sup>3)</sup>		To EU EMC Directive <sup>2)</sup> To EU RoHS Directive
UKCA marking (see declaration of conformity) <sup>3)</sup>		To UK instructions for EMC <sup>2)</sup> To UK RoHS instructions
KC mark		KC EMC
Certification		c UL us - Listed (OL) RCM
Degree of protection		IP65/IP67
Note on degree of protection		In mounted state Unused connections sealed

- 1) Additional information: [www.festo.com/x/topic/kbk](http://www.festo.com/x/topic/kbk)
- 2) For information about the area of use, see the EC declaration of conformity at: [www.festo.com/catalogue/...](http://www.festo.com/catalogue/...) → Support/Downloads.  
If the devices are subject to usage restrictions in residential, commercial or light-industrial environments, further measures for the reduction of the emitted interference may be necessary.
- 3) Additional information: [www.festo.com/catalogue/...](http://www.festo.com/catalogue/...) → Support/Downloads.

### Dimensions

Download CAD data → [www.festo.com](http://www.festo.com)

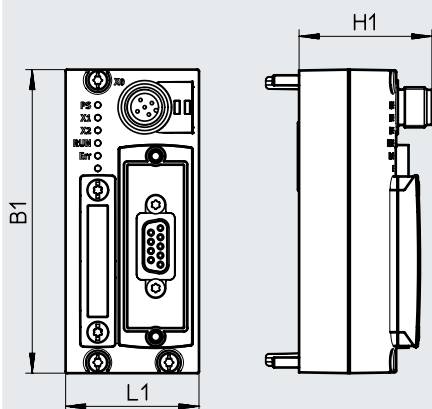

Type	B1	H1	L1
CTEU-CC	91	39.8	40

### Pin allocation

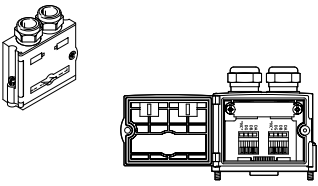

	Pin	Allocation	Description
<b>Sub-D, 9-pin, CC-Link interface</b>			
	1	n.c.	Not connected
	2	DA	Data transmission line A
	3	DG	Data transmission line ground (data reference potential)
	4	n.c.	Not connected
	5	n.c.	Not connected
	6	n.c.	Not connected
	7	DB	Data transmission line B
	8	n.c.	Not connected
	9	n.c.	Not connected
	Housing		Cable shielding, connection to functional earth FE
<b>Power supply, M12, A-coded</b>			
	1	24V <sub>EL/SEN</sub>	Operating voltage supply (electronics, sensors/inputs)
	2	24V <sub>VAL/OUT</sub>	Load voltage supply (valves/outputs)
	3	0V <sub>EL/SEN</sub>	Operating voltage supply (electronics, sensors/inputs)
	4	0V <sub>VAL/OUT</sub>	Load voltage supply (valves/outputs)
	5	FE	Functional earth

## Datasheet – CTEU-CC

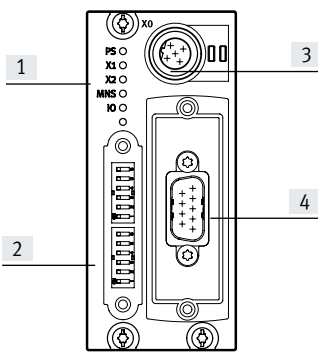
Pin allocation		
Terminal allocation	Pin	Description
<b>Bus connection, FBS-SUB-9-GS-24XPOL-B</b>		
	DA	Data transmission line A
	DB	Data transmission line B
	DG	Data transmission line ground (data reference potential)
	n.c.	Not connected
	FE	Connected to the housing of the Sub-D plug with a clamping clip

Connection and display components	
	<ul style="list-style-type: none"> <li>[1] Status LED (operating status/diagnostics)</li> <li>[2] DIL switch</li> <li>[3] Power supply for bus node and connected devices (valve terminal)</li> <li>[4] Fieldbus interface (Sub-D socket)</li> </ul>

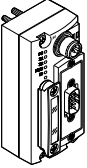
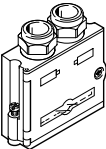
## Accessories – CTEU-CC

Ordering data		Part no.	Type
<b>Bus node</b>			
	CC-Link bus node	1544198	CTEU-CC
<b>Bus connection</b>			
	Sub-D plug, straight	532220	FBS-SUB-9-GS-2x4POL-B
<b>Fitting</b>			
	Threaded sleeve for Sub-D	533000	UNC4-40/M3X8
<b>Plug socket</b>			
	For power supply, M12x1, 5-pin	18324	FBSD-GD-9-5POL

## Datasheet – CTEU-PB



The bus node handles communication between the valve terminal and a higher-order master for PROFIBUS DP®.

The module has basic diagnostic functions. It has 4 integrated LEDs for on-site display. A maximum of 8 byte inputs and 8 byte outputs are transmitted in the cyclic process image.

**Application**

## Fieldbus connection

The bus connection is established via a 9-pin Sub-D socket with the typical PROFIBUS allocation (to EN 50170).

The bus connector plug (with IP65/IP67 degree of protection from Festo or IP20 degree of protection from other manufacturers) facilitates the connection of an incoming and an outgoing bus cable.

An active bus terminal can be connected using the DIL switch integrated in the plug.

The Sub-D interface is designed for controlling network components with a fibre-optic cable connection.

## Transmission rate/overview of cable lengths

- RS 485 transceiver used: Analog Devices ADM 2485
- PROFIBUS slave controller used: Profichip VPC+S

Possible transmission rate:	Maximum fieldbus length:	Maximum branch line length:
9.6 kbps	1200 m	500 m
19.2 kbps	1200 m	500 m
93.75 kbps	1200 m	100 m
187.5 kbps	1000 m	33.3 m
500 kbps	400 m	20 m
1.5 Mbps	200 m	6.6 m
3 Mbps ... 12 Mbps	100 m	–

**General technical data**
**Fieldbus interface**

Protocol	PROFIBUS DP	
Function	Bus connection incoming/outgoing	
Transmission rate	[kbps]	9.6, 19.2, 93.75, 187.5, 500
	[Mbps]	1.5, 12
Type	PROFIBUS	
Connection type	Socket	
Connection technology	Sub-D	
Number of pins/wires	9	
Galvanic isolation	Yes	
Internal cycle time	1 ms per 1 byte of user data	
Note: Optional connection technology with accessories:	Plug/socket M12x1 B-coded, 5-pin, degree of protection IP65	

**Inputs/outputs**

Max. address volume inputs	[byte]	16
Max. address volume for outputs	[byte]	16

## Datasheet – CTEU-PB

General data		
Device-specific diagnostics		System diagnostics
		Undervoltage Communication error
Parameterisation		Diagnostic behaviour Fail-safe response
		Emergency message System status via diagnostic test
Configuration support		GSD file
Control elements		DIL switches
LED indicator	Product-specific	PS: Operating voltage for electronics and load supply X1: System status of module at I-Port 1 X2: System status of module at I-Port 2
	Fieldbus-specific	BF: Bus fault
Technical data – Electrics		
Nominal operating voltage	[V DC]	24
Operating voltage range	[V DC]	18 ... 30
Intrinsic current consumption at nominal operating voltage	[mA]	Typically 100
Max. power supply	[A]	4
Power supply		
Function		Electronics and load
Connection type		Plug
Connection technology		M12x1, A-coded to EN 61076-2-101
Number of pins/wires		5
Technical data – Mechanical components		
Type of mounting		On electrical connection block On electrical interface
Product weight	[g]	90 (without fieldbus connector and without interlinking module)
Grid dimension	[mm]	40
Dimensions W x L x H	[mm]	40 x 91 x 50
Materials		
Housing		PA
Note on materials		RoHS-compliant Contains paint-wetting impairment substances

Datasheet – CTEU-PB

Operating and environmental conditions			
Type		CTEU-PB	CTEU-PB-EX1C
Ambient temperature	[°C]	-5 ... +50	-5 ... +50
Storage temperature	[°C]	-20 ... +70	-20 ... +70
Corrosion resistance class CRC <sup>1)</sup>		2	2
CE marking (see declaration of conformity) <sup>3)</sup>		To EU EMC Directive <sup>2)</sup>	To EU EMC Directive <sup>2)</sup>
		To EU RoHS Directive	To EU RoHS Directive
UKCA marking (see declaration of conformity) <sup>3)</sup>		To UK instructions for EMC <sup>2)</sup>	To UK instructions for EMC <sup>2)</sup>
		To UK RoHS instructions	To UK RoHS instructions
KC mark		KC EMC	-
Certification		c UL us - Listed (OL)	-
		RCM	RCM
Degree of protection		IP65/IP67	IP65/IP67
Note on degree of protection		In mounted state	In mounted state
		Unused connections sealed	Unused connections sealed

- 1) Additional information: [www.festo.com/x/topic/kbk](http://www.festo.com/x/topic/kbk)
- 2) For information about the area of use, see the EC declaration of conformity at: [www.festo.com/catalogue/...](http://www.festo.com/catalogue/...) → Support/Downloads.  
If the devices are subject to usage restrictions in residential, commercial or light-industrial environments, further measures for the reduction of the emitted interference may be necessary.
- 3) Additional information: [www.festo.com/catalogue/...](http://www.festo.com/catalogue/...) → Support/Downloads.

Dimensions

Download CAD data → [www.festo.com](http://www.festo.com)

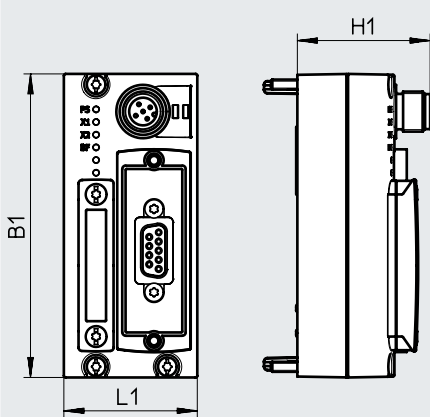

Type	B1	H1	L1
CTEU-PB	91	39.8	40

Pin allocation

	Pin	Allocation	Description
<b>Sub-D, 9-pin, PROFIBUS interface</b>			
	1	Shielding	Functional earth
	2	n.c.	Not connected
	3	RxD/TxD-P	Received/transmitted data positive
	4	CNTR-P	Repeater control signal
	5	DGND	Data reference potential
	6	VP	Supply voltage positive (+ 5 V)
	7	n.c.	Not connected
	8	RxD/TxD-N	Received/transmitted data negative
	9	n.c.	Not connected
Housing		Cable shielding, connection to functional earth FE	
<b>Power supply, M12, A-coded</b>			
	1	24V <sub>EL/SEN</sub>	Operating voltage supply (electronics, sensors/inputs)
	2	24V <sub>VAL/OUT</sub>	Load voltage supply (valves/outputs)
	3	0V <sub>EL/SEN</sub>	Operating voltage supply (electronics, sensors/inputs)
	4	0V <sub>VAL/OUT</sub>	Load voltage supply (valves/outputs)
	5	FE	Functional earth

## Datasheet – CTEU-PB

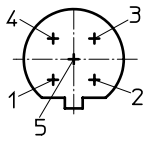
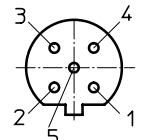
Pin allocation			
	Pin	Allocation	Description
<b>Bus connection M12 adapter (B-coded)</b>			
Incoming 	1	n.c.	Not connected
	2	RxD/TxD-N	Received/transmitted data N
	3	n.c.	Not connected
	4	RxD/TxD-P	Received/transmitted data P
	5 and M12	Shielding	Connection to FE (functional earth)
Outgoing 	1	VP	Supply voltage (P5V)
	2	RxD/TxD-N	Received/transmitted data N
	3	DGND	Data reference potential (M5V)
	4	RxD/TxD-P	Received/transmitted data P
	5 and M12	Shielding	Connection to FE (functional earth)

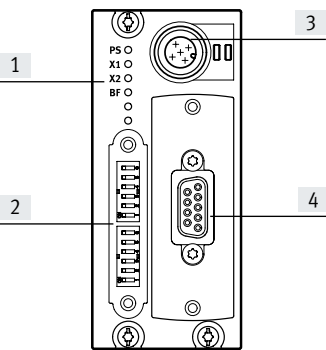
Connection and display components	
	<ul style="list-style-type: none"> <li>[1] Status LED (operating status/diagnostics)</li> <li>[2] DIL switch</li> <li>[3] Power supply for bus node and connected devices (valve terminal)</li> <li>[4] Fieldbus interface (Sub-D socket)</li> </ul>



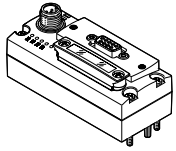

## Accessories – CTEU-PB

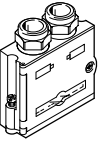
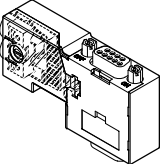
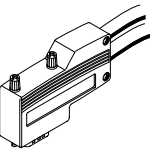
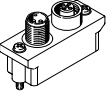
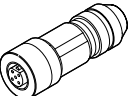
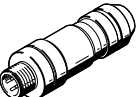
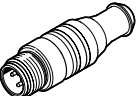
Ordering data – Bus node				Part no.	Type
	PROFIBUS bus node	Certification cUL us - Listed (OL)	KC mark KC-EMC	570040	CTEU-PB
				8107588	CTEU-PB-EX1C

Ordering data – Accessories for CTEU-PB				Part no.	Type
<b>Bus connection</b>					
	Sub-D plug, straight			532216	FBS-SUB-9-GS-DP-B
	Sub-D plug, straight, with terminating resistor and programming interface			574589	NECU-S1W9-C2-APB
	Sub-D plug, angled			533780	FBS-SUB-9-WS-PB-K
	Bus connection M12 adapter, B-coded			533118	FBA-2-M12-5POL-RK
	Straight socket, M12x1, 5-pin, for assembling a connecting cable compatible with FBA-2-M12-5POL-RK			1067905	NECU-M-B12G5-C2-PB
	Straight plug, M12x1, 5-pin, for assembling a connecting cable compatible with FBA-2-M12-5POL-RK			1066354	NECU-M-S-B12G5-C2-PB
	Terminating resistor, M12, B-coded for PROFIBUS			1072128	CACR-S-B12G5-220-PB

<b>Fitting</b>					
	Threaded sleeve for Sub-D			533000	UNC4-40/M3X8

<b>Plug socket</b>					
	For power supply, M12x1, 5-pin			18324	FBSD-GD-9-5POL

<b>User documentation</b>					
	User documentation – bus node CTEU-PB	German	575392	P.BE-CTEU-PB-OP+MAINT-DE	
		English	575393	P.BE-CTEU-PB-OP+MAINT-EN	
		Spanish	575394	P.BE-CTEU-PB-OP+MAINT-ES	
		French	575395	P.BE-CTEU-PB-OP+MAINT-FR	
		Italian	575396	P.BE-CTEU-PB-OP+MAINT-IT	
		Chinese	575397	P.BE-CTEU-PB-OP+MAINT-ZH	

## Accessories – CTEU-PB

Ordering data – Accessories for CTEU-PB-EX1C		Part no.	Type
<b>Identification holder</b>			
	5 frames with 40 pieces each	<b>565306</b>	<b>ASLR-C-E4</b>

Datasheet – CTEU-EC



The bus node handles communication between the valve terminal and a higher-order master for EtherCAT®.

The module has basic diagnostic functions.

It has 6 integrated status LEDs for on-site display.

A maximum of 16 byte inputs and 16 byte outputs are transmitted in the cyclic process image.



**Application**

**Fieldbus connection**

The bus connection is established via two M12 sockets, D-coded to IEC 61076-2-101 with degree of protection IP65/IP67.

Both connections are equivalent 100BaseTX Ethernet ports with integrated auto MDI functionality (cross-over and patch cables can be used) that are brought together via an internal switch.

The module has a system and load supply, a fieldbus connection and a connection to the valve terminal with serial I-Port interface.

Please observe the applicable specifications such as the cable specifications for Ethernet networks ISO/IEC 11801 and ANSI/TIA/EIA-568-B.

- Maximum cable length (between network stations): 100 m
- Transmission rate: 100 Mbps
- EtherCAT communication chip: ASIC ET1100

**EtherCAT bus node**

The EtherCAT bus node supports the EtherCAT protocol based on the Ethernet standard and TCP/IP technology to IEEE802.3.

This guarantees a data exchange with a high data transmission rate, for example I/O data from sensors, actuators or robot controllers, PLCs or process equipment. In addition, non-real-time critical information such as diagnostic

information, configuration information, etc. can be transferred.

The data bandwidth is sufficient to transfer both data types (real-time and non-real-time) in parallel.

The bus node has a system and load supply, EtherCAT input and output port, LEDs for status and diagnostic messages and DIL switches. Diagnos-

tics is possible directly at the bus node and/or via fieldbus.

The bus node has separate operating and load voltage supplies.

The bus node is mounted on an I-Port compatible device (e.g. valve terminal or electrical connection block) from Festo.

The bus node supplies voltage to downstream devices connected via the I-Port interface.

The following can be set via DIL switch:

- Station addresses
- Diagnostics on/off
- Fail state behaviour

**General technical data**

Fieldbus interface		
Protocol		EtherCAT
Function		Bus connection incoming/outgoing
Transmission rate	[Mbps]	100
Type		Ethernet
Connection type		2 x socket
Connection technology		M12x1, D-coded to EN 61076-2-101
Number of pins/wires		4
Galvanic isolation		Yes
Internal cycle time		1 ms per 1 byte of user data
Inputs/outputs		
Max. address volume inputs	[byte]	16
Max. address volume for outputs	[byte]	16

## Datasheet – CTEU-EC

General data		
Device-specific diagnostics		System diagnostics
		Undervoltage
Parameterisation		Communication error
		Activating diagnostics
Additional functions		Fail-safe and idle response
		Diagnostics object
		Acyclic data access via SDO
		Emergency message
Configuration support		Modular Device Profile (MDP)
		XML file
Control elements		DIL switches
LED indicator	Product-specific	PS: Operating voltage for electronics and load supply
		X1: System status of module at I-Port 1
		X2: System status of module at I-Port 2
	Fieldbus-specific	Run: Operating status (communication status)
		L/A2: Network active (connection status) port 2 (Out)
		L/A1: Network active (connection status) port 1 (In)
Technical data – Electrics		
Nominal operating voltage	[V DC]	24
Operating voltage range	[V DC]	18 ... 30
Intrinsic current consumption at nominal operating voltage	[mA]	Typically 60
Max. power supply	[A]	4
Power supply		
Function		Electronics and load
Connection type		Plug
Connection technology		M12x1, A-coded to EN 61076-2-101
Number of pins/wires		5
Technical data – Mechanical components		
Type of mounting		On electrical connection block
		On electrical interface
Product weight	[g]	90 (without fieldbus connector and without interlinking module)
Grid dimension	[mm]	40
Dimensions W x L x H	[mm]	40 x 91 x 50
Materials		
Housing		PA
Note on materials		RoHS-compliant
		Contains paint-wetting impairment substances

## Datasheet – CTEU-EC

Operating and environmental conditions		
Ambient temperature	[°C]	-5 ... +50
Storage temperature	[°C]	-20 ... +70
Corrosion resistance class CRC <sup>1)</sup>		2
CE marking (see declaration of conformity) <sup>3)</sup>		To EU EMC Directive <sup>2)</sup>
		To EU RoHS Directive
UKCA marking (see declaration of conformity) <sup>3)</sup>		To UK instructions for EMC <sup>2)</sup>
		To UK RoHS instructions
KC mark		KC EMC
Certification		c UL us - Listed (OL)
		RCM
Degree of protection		IP65/IP67
Note on degree of protection		In mounted state
		Unused connections sealed

1) Additional information: [www.festo.com/x/topic/kbk](http://www.festo.com/x/topic/kbk)

2) For information about the area of use, see the EC declaration of conformity at: [www.festo.com/catalogue/...](http://www.festo.com/catalogue/...) → Support/Downloads.

If the devices are subject to usage restrictions in residential, commercial or light-industrial environments, further measures for the reduction of the emitted interference may be necessary.

3) Additional information: [www.festo.com/catalogue/...](http://www.festo.com/catalogue/...) → Support/Downloads.

## Dimensions

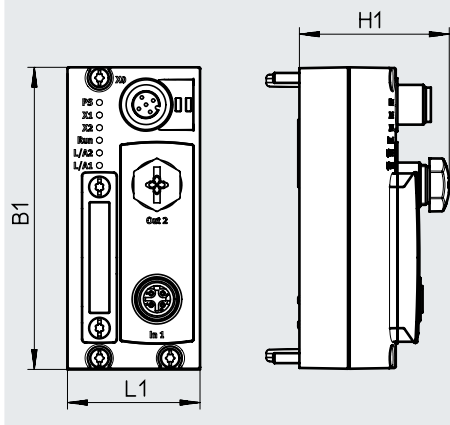

[Download CAD data → www.festo.com](http://www.festo.com)

Type	B1	H1	L1
CTEU-EC	91	45.3	40

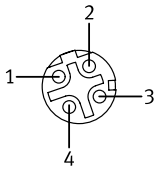
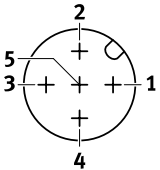
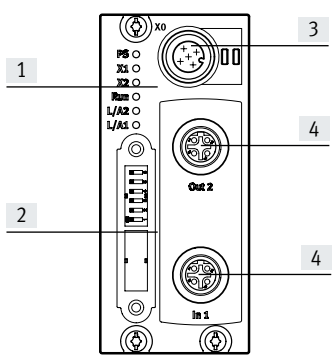
Datasheet – CTEU-EC

Pin allocation			
	Pin	Allocation	Description
<b>EtherCAT interface, M12, D-coded</b>			
	1	TX+	Transmitted data+
	2	RX+	Received data+
	3	TX-	Transmitted data-
	4	RX-	Received data-
	Housing		Cable shielding, connection to functional earth FE
<b>Power supply, M12, A-coded</b>			
	1	24V <sub>EL/SEN</sub>	Operating voltage supply (electronics, sensors/inputs)
	2	24V <sub>VAL/OUT</sub>	Load voltage supply (valves/outputs)
	3	0V <sub>EL/SEN</sub>	Operating voltage supply (electronics, sensors/inputs)
	4	0V <sub>VAL/OUT</sub>	Load voltage supply (valves/outputs)
	5	FE	Functional earth
<b>Connection and display components</b>			
	<ul style="list-style-type: none"> <li>[1] Status LED (operating status/diagnostics)</li> <li>[2] DIL switch</li> <li>[3] Power supply for bus node and connected devices (valve terminal)</li> <li>[4] Fieldbus connection (M12 socket, D-coded)</li> </ul>		

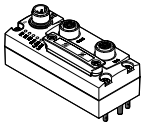
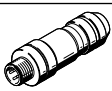
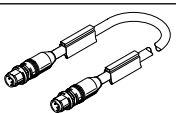
## Accessories – CTEU-EC

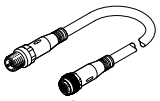
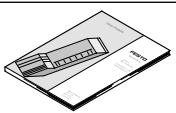
Ordering data				Part no.	Type
<b>Bus node</b>					
	EtherCAT bus node			572556	CTEU-EC
<b>Plug for bus connection</b>					
	Plug M12x1, 4-pin, D-coded			543109	NECU-M-S-D12G4-C2-ET
<b>Connecting cable for bus connection</b>					
	Straight plug, M12x1, 4-pin, D-coded	Straight plug, M12x1, 4-pin, D-coded	0.5 m	8040446	NEBC-D12G4-ES-0.5-S-D12G4-ET
			1 m	8040447	NEBC-D12G4-ES-1-S-D12G4-ET
			3 m	8040448	NEBC-D12G4-ES-3-S-D12G4-ET
			5 m	8040449	NEBC-D12G4-ES-5-S-D12G4-ET
			10 m	8040450	NEBC-D12G4-ES-10-S-D12G4-ET
		Straight plug, RJ45, 8-pin	1 m	8040451	NEBC-D12G4-ES-1-S-R3G4-ET
			3 m	8040452	NEBC-D12G4-ES-3-S-R3G4-ET
			5 m	8040453	NEBC-D12G4-ES-5-S-R3G4-ET
			10 m	8040454	NEBC-D12G4-ES-10-S-R3G4-ET
			Open end, 4-wire	5 m	8040456
<b>Plug socket for power supply</b>					
	Socket M12x1, 5-pin			18324	FBSD-GD-9-5POL
<b>Connecting cable for power supply</b>					
	<ul style="list-style-type: none"> <li>Socket M12x1, 5-pin</li> <li>Plug M12x1, 5-pin</li> </ul>	Suitable for energy chains	5 m	574321	NEBU-M12G5-E-5-Q8N-M12G5
			7.5 m	574322	NEBU-M12G5-E-7.5-Q8N-M12G5
			10 m	574323	NEBU-M12G5-E-10-Q8N-M12G5
		Standard	0.5 m	570733	NEBU-M12W5-K-0.5-M12W5
				8003617	NEBU-M12G5-K-0.5-M12W5
			2 m	570734	NEBU-M12W5-K-2-M12W5
		8003618	NEBU-M12G5-K-2-M12W5		
<b>User documentation</b>					
	User documentation – bus node CTEU-EC	User documentation – bus node CTEU-EC	German	575400	P.BE-CTEU-EC-OP+MAINT-DE
			English	575401	P.BE-CTEU-EC-OP+MAINT-EN
			Spanish	575402	P.BE-CTEU-EC-OP+MAINT-ES
			French	575403	P.BE-CTEU-EC-OP+MAINT-FR
			Italian	575404	P.BE-CTEU-EC-OP+MAINT-IT
			Chinese	575405	P.BE-CTEU-EC-OP+MAINT-ZH

## Datasheet – CTEU-AS



The bus node handles communication between the valve terminal and a higher-order AS-Interface® master.

- Activation of up to 16 solenoid coils per valve terminal
- Automatic addressing
- Automatic detection of the number of connected valves



### Characteristics

The module has a system and load supply, a bus connection and a connection to the valve terminal with serial I-Port interface.

The module has basic diagnostic functions. It has 3 integrated LEDs for on-site display.

A maximum of 2 byte inputs and 2 byte outputs are transmitted in the cyclic process image.

### General technical data

#### Fieldbus interface 1

Protocol	AS-Interface
Function	Incoming bus connection Power supply
Type	AS-Interface
Connection type	Plug
Connection technology	M12x1, A-coded to EN 61076-2-101
Number of pins/wires	4
Internal cycle time	[ms] 10

#### Fieldbus interface 2

Function	Bus connection outgoing Power supply
Connection type	Socket
Connection technology	M12x1, A-coded to EN 61076-2-101
Number of pins/wires	4

#### Inputs/outputs

Max. address volume inputs	[byte]	2
Max. address volume for outputs	[byte]	2



## Datasheet – CTEU-AS

General data		
Device-specific diagnostics		System diagnostics
		Undervoltage
		Communication error
Parameterisation		Watchdog enable
		Watchdog disable
Additional functions		Emergency message
		Acyclic data access via SDO
Configuration support		None
Control elements		DIL switches
LED indicator	Product-specific	PS: Operating voltage for electronics and load supply
		X1: System status of module at I-Port 1
	Fieldbus-specific	AS-i: AS-Interface operation

Technical data – Electrics		
Nominal operating voltage	[V DC]	30
Operating voltage range	[V DC]	20 ... 31.6
Intrinsic current consumption at nominal operating voltage	[mA]	Typically 50
Max. power supply	[A]	4

Technical data – Mechanical components		
Type of mounting		On electrical connection block
		On electrical interface
Product weight	[g]	90 (without AS-i plug and without interlinking module)
Grid dimension	[mm]	40
Dimensions W x L x H	[mm]	40 x 91 x 50

Materials	
Housing	PA
Note on materials	RoHS-compliant
	Contains paint-wetting impairment substances

Operating and environmental conditions		
Ambient temperature	[°C]	-5 ... +50
Storage temperature	[°C]	-20 ... +70
Corrosion resistance class CRC <sup>1)</sup>		2
CE marking (see declaration of conformity) <sup>3)</sup>		To EU EMC Directive <sup>2)</sup>
		To EU RoHS Directive
UKCA marking (see declaration of conformity) <sup>3)</sup>		To UK instructions for EMC <sup>2)</sup>
		To UK RoHS instructions
Certification		c UL us - Listed (OL)
Degree of protection		IP65/IP67
Note on degree of protection		In mounted state
		Unused connections sealed

1) Additional information: [www.festo.com/x/topic/kbk](http://www.festo.com/x/topic/kbk)

2) For information about the area of use, see the EC declaration of conformity at: [www.festo.com/catalogue/...](http://www.festo.com/catalogue/...) → Support/Downloads.

If the devices are subject to usage restrictions in residential, commercial or light-industrial environments, further measures for the reduction of the emitted interference may be necessary.

3) Additional information: [www.festo.com/catalogue/...](http://www.festo.com/catalogue/...) → Support/Downloads.

## Datasheet – CTEU-AS

### Dimensions

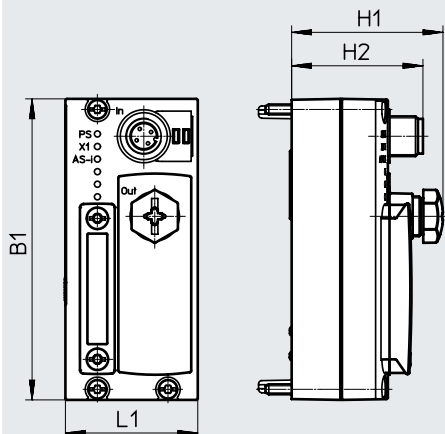

Type	B1	H1	H2	L1
CTEU-AS	91	45.3	39.7	40



### Pin allocation

	Pin	Allocation
<b>M12 plug, AS-interface In</b>		
	1	AS-Interface +
	2	24 V load voltage supply
	3	AS-Interface –
	4	0 V load voltage supply
<b>M12 socket, AS-i Out</b>		
	1	AS-Interface +
	2	24 V load voltage supply
	3	AS-Interface –
	4	0 V load voltage supply

### Connection and display components

	<ul style="list-style-type: none"> <li>[1] Status LED (operating status/diagnostics)</li> <li>[2] DIL switch</li> <li>[3] M12 plug, AS-Interface bus and auxiliary power supply (AS-i In)</li> <li>[4] M12 socket, AS-Interface bus and auxiliary power supply (AS-i Out)</li> </ul>
--	--------------------------------------------------------------------------------------------------------------------------------------------------------------------------------------------------------------------------------------------------------------------------------------

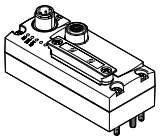
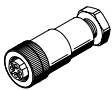
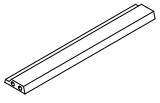
## Accessories – CTEU-AS

Ordering data		Part no.	Type
<b>Bus node</b>			
	AS-Interface bus node	572555	CTEU-AS
<b>Cable socket without load voltage supply</b>			
	Flat cable, screw terminal	4-pin straight socket, M12x1, A-coded	18789 ASI-SD-PG-M12
<b>Flat cable</b>			
	AS-Interface flat cable	Yellow	18940 KASI-1.5-Y-100
		Black	18941 KASI-1.5-Z-100
	Cable sleeve for insulating and sealing the flat cable		165593 ASI-KT-FK
	Cable cap for insulating and sealing the flat cable		18787 ASI-KK-FK

## Datasheet – CTEU-PN



The bus node handles communication between the valve terminal and a higher-order PROFINET® master.

The module has basic diagnostic functions. It has 6 integrated LEDs for on-site display. A maximum of 64 byte inputs and 64 byte outputs are transmitted in the cyclic process image.

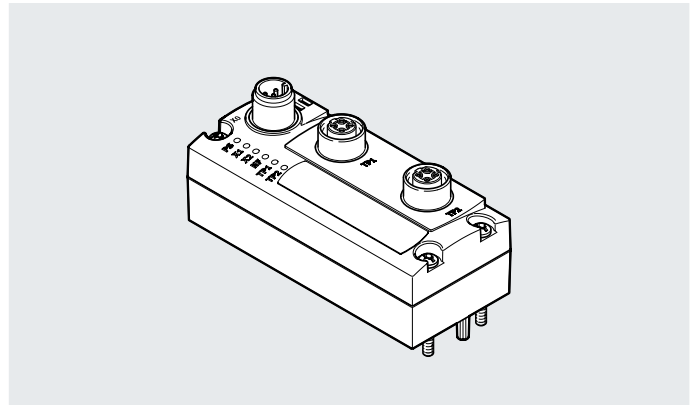

### Application

#### Fieldbus connection

The bus connection is established via two M12 sockets, D-coded to IEC 61076-2-101 with degree of protection IP65, IP67.

Both connections are equivalent 100BaseTX Ethernet ports (as per IEEE 802.3).

There is also an integrated switch function that enables free selection of the ports TP1/TP2 for PROFINET communication.

The voltage for the CTEU-PN bus node is supplied via an M12 plug, 5-pin, A-coded.

#### I-Port interface

The bus node supports two interfaces for connecting I-Port devices.

When mounting the bus node on a valve terminal (direct integration), only one interface is used.

When using the bus node CTEU-PN on the electrical connection block CAPC (installation system CTEL),

both interfaces are available via the electrical connection block.

### General technical data

#### Fieldbus interface

Protocol		PROFINET RT
Function		Bus connection incoming/outgoing
Transmission rate	[Mbps]	100
Type		Ethernet
Connection type		2 x socket
Connection technology		M12x1, D-coded to EN 61076-2-101
Number of pins/wires		4
Galvanic isolation		Yes
Internal cycle time		1 ms per 1 byte of user data

#### Inputs/outputs

Max. address volume inputs	[byte]	64
Max. address volume for outputs	[byte]	64

## Datasheet – CTEU-PN

General data		
Device-specific diagnostics		System diagnostics
		Undervoltage
		Communication error
Additional functions		Conformance class C
		Fast start-up (FSU)
		LLDP
		MRP
		PROFINET IRT
		PROFenergy
		SNMP
		Shared device
Configuration support		GSDML file
LED indicator	Product-specific	PS: Operating voltage for electronics and load supply
		X1: System status of module at I-Port 1
		X2: System status of module at I-Port 2
	Fieldbus-specific	NF: Network fault
		TP1: Network active port 1
		TP2: Network active port 2
Technical data – Electrics		
Nominal operating voltage	[V DC]	24
Operating voltage range	[V DC]	18 ... 30
Intrinsic current consumption at nominal operating voltage	[mA]	Typically 80
Max. power supply	[A]	4
Power supply		
Function		Electronics and load
Connection type		Plug
Connection technology		M12x1, A-coded to EN 61076-2-101
Number of pins/wires		5
Technical data – Mechanical components		
Type of mounting		On electrical connection block
		On electrical interface
Product weight	[g]	93
Grid dimension	[mm]	40
Dimensions W x L x H	[mm]	40 x 91 x 50
Materials		
Housing		PA
Note on materials		RoHS-compliant
		Contains paint-wetting impairment substances

## Datasheet – CTEU-PN

Operating and environmental conditions		CTEU-PN	CTEU-PN-EX1C
Type		CTEU-PN	CTEU-PN-EX1C
Ambient temperature	[°C]	-5 ... +50	-5 ... +50
Storage temperature	[°C]	-20 ... +70	-20 ... +70
Corrosion resistance class CRC <sup>1)</sup>		2	2
CE marking (see declaration of conformity) <sup>3)</sup>		To EU EMC Directive <sup>2)</sup>	To EU EMC Directive <sup>2)</sup>
		To EU RoHS Directive	To EU RoHS Directive
UKCA marking (see declaration of conformity) <sup>3)</sup>		To UK instructions for EMC <sup>2)</sup>	To UK instructions for EMC <sup>2)</sup>
		To UK RoHS instructions	To UK RoHS instructions
KC mark		KC EMC	-
Certification		c UL us - Listed (OL)	-
		RCM	RCM
Degree of protection		IP65/IP67	IP65/IP67
Note on degree of protection		In mounted state	In mounted state
		Unused connections sealed	Unused connections sealed

1) Additional information: [www.festo.com/x/topic/kbk](http://www.festo.com/x/topic/kbk)

2) For information about the area of use, see the EC declaration of conformity at: [www.festo.com/catalogue/...](http://www.festo.com/catalogue/...) → Support/Downloads.

If the devices are subject to usage restrictions in residential, commercial or light-industrial environments, further measures for the reduction of the emitted interference may be necessary.

3) Additional information: [www.festo.com/catalogue/...](http://www.festo.com/catalogue/...) → Support/Downloads.

### Dimensions

Download CAD data → [www.festo.com](http://www.festo.com)

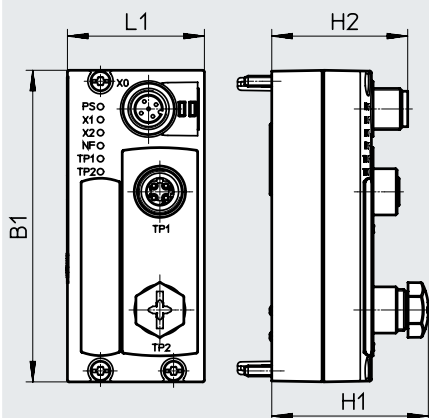

Type	B1	H1	H2	L1
CTEU-PN	91	45.7	39.7	40

Datasheet – CTEU-PN

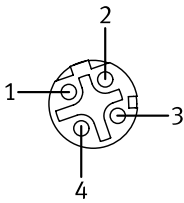
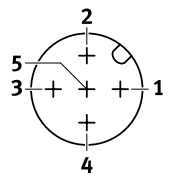
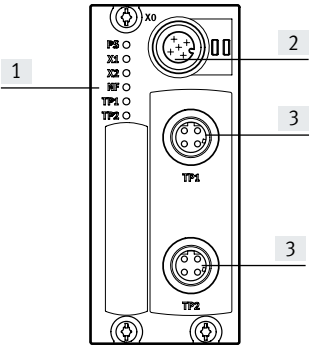
Pin allocation		Pin	Allocation	Description
<b>PROFINET interface, M12 socket, 4-pin, D-coded</b>				
	1	TX+	Differential transmitter cable, positive signal	
	2	RX+	Differential receiver cable, positive signal	
	3	TX-	Differential transmitter cable, negative signal	
	4	RX-	Differential receiver cable, negative signal	
	Housing		Functional earth	
<b>Power supply, M12 plug, 5-pin, A-coded</b>				
	1	24V <sub>EL/SEN</sub>	Operating voltage supply (internal electronics, I-Port devices)	
	2	24V <sub>VAL/OUT</sub>	Load voltage supply (I-Port devices)	
	3	0V <sub>EL/SEN</sub>	Operating voltage supply (internal electronics, I-Port devices)	
	4	0V <sub>VAL/OUT</sub>	Load voltage supply (I-Port devices)	
	5	FE	Functional earth	
<b>Connection and display components</b>				
		<ul style="list-style-type: none"> <li>[1] Status LED (operating status/diagnostics)</li> <li>[2] Power supply for bus node and connected devices (valve terminal)</li> <li>[3] Fieldbus connection</li> </ul>		

## Accessories CTEU-PN

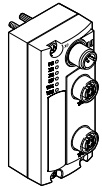
Ordering data – Bus node				Part no.	Type
	PROFINET bus node	Certification c UL us - Listed (OL)	KC mark KC-EMC	2201471	CTEU-PN
		–	–	8107589	CTEU-PN-EX1C

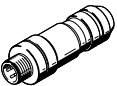
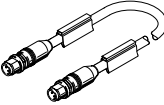
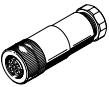
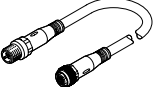
Ordering data – Accessories for CTEU-PN				Part no.	Type	
<b>Plug for bus connection</b>						
	Plug M12x1, 4-pin, D-coded			543109	NECU-M-S-D12G4-C2-ET	
<b>Connecting cable for bus connection</b>						
	Straight plug, M12x1, 4-pin, D-coded	Straight plug, M12x1, 4-pin, D-coded	0.5 m	8040446	NEBC-D12G4-ES-0.5-S-D12G4-ET	
			1 m	8040447	NEBC-D12G4-ES-1-S-D12G4-ET	
			3 m	8040448	NEBC-D12G4-ES-3-S-D12G4-ET	
			5 m	8040449	NEBC-D12G4-ES-5-S-D12G4-ET	
			10 m	8040450	NEBC-D12G4-ES-10-S-D12G4-ET	
			Straight plug, RJ45, 8-pin	1 m	8040451	NEBC-D12G4-ES-1-S-R3G4-ET
				3 m	8040452	NEBC-D12G4-ES-3-S-R3G4-ET
				5 m	8040453	NEBC-D12G4-ES-5-S-R3G4-ET
			Open end, 4-wire	10 m	8040454	NEBC-D12G4-ES-10-S-R3G4-ET
				5 m	8040456	NEBC-LE4-ES-5-D12G4-ET
<b>Plug socket for power supply</b>						
	Socket M12x1, 5-pin			18324	FBSD-GD-9-5POL	
<b>Connecting cable for power supply</b>						
	<ul style="list-style-type: none"> <li>Socket M12x1, 5-pin</li> <li>Plug M12x1, 5-pin</li> </ul>	Suitable for energy chains	5 m	574321	NEBU-M12G5-E-5-Q8N-M12G5	
			7.5 m	574322	NEBU-M12G5-E-7.5-Q8N-M12G5	
			10 m	574323	NEBU-M12G5-E-10-Q8N-M12G5	
		Standard		0.5 m	570733	NEBU-M12W5-K-0.5-M12W5
					8003617	NEBU-M12G5-K-0.5-M12W5
				2 m	570734	NEBU-M12W5-K-2-M12W5
					8003618	NEBU-M12G5-K-2-M12W5



## Datasheet – CTEU-EP

### EtherNet/IP™

The bus node handles communication between the valve terminal and a higher-order master via Ethernet.

The module has basic diagnostic functions. It has 6 integrated LEDs for on-site display. A maximum of 64 byte inputs and 64 byte outputs are transmitted in the cyclic process image



### Application

The bus node CTEU-EP is a module within the CTEU series which can be used to connect I-Port devices with

specification V1.0 to an EtherNet/IP or Modbus/TCP bus. Depending on the installation, the bus

node provides two I-Port interfaces for the connection of I-Port devices.

### Installation

#### Direct integration

- Mounting the bus node on an I-Port device, e.g. valve terminal
- One I-Port interface available (for internal communication)

#### Adapter CAPC

- Mounting the bus node on the adapter
- Two I-Port interfaces available on the adapter

#### Power supply

The power is supplied to the bus node and the connected I-Port devices via an M12 plug, 5-pin, A-coded, on the top side of the housing.

#### Ethernet connection

The bus node CTEU-EP provides two 100BASE-TX Ethernet interfaces (as per IEEE802.3) that are electrically isolated from the rest of the internal electronics. The integrated switch function differentiates automatically between the incoming and outgoing Ethernet connection, regardless of the network connection used.

### General technical data

#### Fieldbus interface

Protocol	EtherNet/IP Modbus TCP
Transmission rate [Mbps]	11 0/100
Fieldbus interface	2x socket, M12x1, 4-pin, D-coded
Internal cycle time	1 ms per 1 byte of user data

#### Inputs/outputs

Max. address volume inputs [byte]	64
Max. address volume for outputs [byte]	64

### Technical data – Electrics

Nominal operating voltage [V DC]	24
Operating voltage range [V DC]	18 ... 30
Intrinsic current consumption at nominal operating voltage [mA]	Typically 65
Max. power supply [A]	4

## Datasheet – CTEU-EP

General data		
Device-specific diagnostics		System diagnostics
		Undervoltage
Parameterisation		Communication error
		Diagnostic behaviour
Additional functions		Fail-safe and idle response
		AddressConflictDetection (ACD)
		Acyclic data access via "Explicit Message"
		EtherNet/IP Quickconnect
		IP addressing via DHCP, DIL switch, fieldbus or FFT
		Integrated switch
		Ring topology (DLR)
		SNMP
		Start-up parameterisation in plain text via fieldbus
		System status can be displayed using process data
Configuration support		Webserver
Configuration support		EDS files
Control elements		DIL switches
LED indicator	Product-specific	PS: Operating voltage for electronics and load supply
		X1: System status of module at I-Port 1
		X2: System status of module at I-Port 2
	Fieldbus-specific	TP1: Network active port 1
		TP2: Network active port 2
		NS: Network status

Technical data – Mechanical components		
Product weight	[g]	98
Dimensions W x L x H	[mm]	40 x 91 x 50

Materials	
Housing	PA
Note on materials	RoHS-compliant
	Contains paint-wetting impairment substances

Operating and environmental conditions		CTEU-EP	CTEU-EP-EX1C
Ambient temperature	[°C]	-5 ... +50	-5 ... +50
Storage temperature	[°C]	-20 ... +70	-20 ... +70
Corrosion resistance class CRC <sup>1)</sup>		2	2
CE marking (see declaration of conformity) <sup>3)</sup>		To EU EMC Directive <sup>2)</sup>	To EU EMC Directive <sup>2)</sup>
		To EU RoHS Directive	To EU RoHS Directive
UKCA marking (see declaration of conformity) <sup>3)</sup>		To UK instructions for EMC <sup>2)</sup>	To UK instructions for EMC <sup>2)</sup>
		To UK RoHS instructions	To UK RoHS instructions
KC mark		KC EMC	-
Certification		c UL us - Listed (OL)	-
		RCM	RCM
Degree of protection		IP65/IP67	IP65/IP67

1) Additional information: [www.festo.com/x/topic/kbk](http://www.festo.com/x/topic/kbk)

2) For information about the area of use, see the EC declaration of conformity at: [www.festo.com/catalogue/...](http://www.festo.com/catalogue/...) → Support/Downloads.

If the devices are subject to usage restrictions in residential, commercial or light-industrial environments, further measures for the reduction of the emitted interference may be necessary.

3) Additional information: [www.festo.com/catalogue/...](http://www.festo.com/catalogue/...) → Support/Downloads.

Datasheet – CTEU-EP

Dimensions

Download CAD data → [www.festo.com](http://www.festo.com)

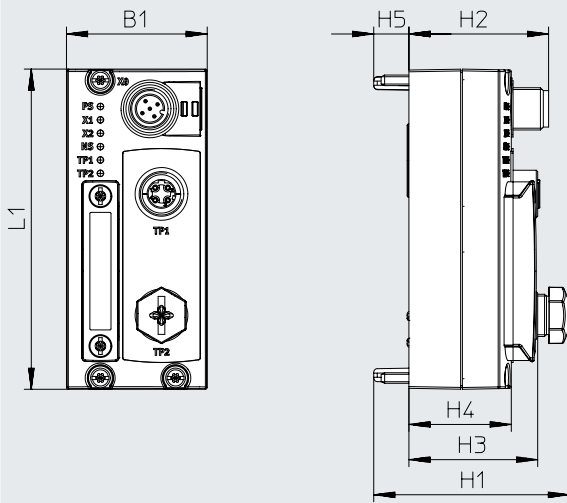

Type	L1	H1	H2	H3	H4	H5	B1
CTEU-EP	91	55.6	39.7	36.6	29.1	10	40

Pin allocation

	Pin	Allocation	Description
<b>Ethernet interface, socket M12, 4-pin, D-coded</b>			
	1	TX+	Differential transmitter cable, positive signal
	2	RX+	Differential receiver cable, positive signal
	3	TX-	Differential transmitter cable, negative signal
	4	RX-	Differential receiver cable, negative signal
	Housing		Functional earth

Power supply, M12, A-coded

	Pin	Allocation	Description
	1	24V <sub>EL/SEN</sub>	Operating voltage supply (electronics, sensors/inputs)
	2	24V <sub>VAL/OUT</sub>	Load voltage supply (valves/outputs)
	3	0V <sub>EL/SEN</sub>	Operating voltage supply (electronics, sensors/inputs)
	4	0V <sub>VAL/OUT</sub>	Load voltage supply (valves/outputs)
	5	FE	Functional earth

Connection and display components

	<ul style="list-style-type: none"> <li>[1] Status LED (operating status/diagnostics)</li> <li>[2] DIL switch</li> <li>[3] Network connections (network ports TP1/TP2, fieldbus interface)</li> <li>[4] Power supply connection</li> </ul>
--	-------------------------------------------------------------------------------------------------------------------------------------------------------------------------------------------------------------------------------------------

Accessories – CTEU-EP

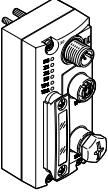
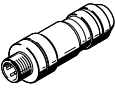
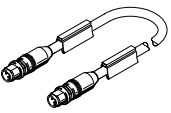
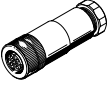
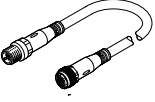
Ordering data				Part no.	Type	
<b>Bus node</b>						
	EP bus node	Certification c UL us - Listed (OL)	KC mark KC-EMC	<b>2798071</b>	<b>CTEU-EP</b>	
		–	–	<b>8107591</b>	<b>CTEU-EP-EX1C</b>	
<b>Plug for bus connection</b>						
	Plug M12x1, 4-pin, D-coded			<b>543109</b>	<b>NECU-M-S-D12G4-C2-ET</b>	
<b>Connecting cable for bus connection</b>						
	Straight plug, M12x1, 4-pin, D-coded	Straight plug, M12x1, 4-pin, D-coded	0.5 m	<b>8040446</b>	<b>NEBC-D12G4-ES-0.5-S-D12G4-ET</b>	
			1 m	<b>8040447</b>	<b>NEBC-D12G4-ES-1-S-D12G4-ET</b>	
			3 m	<b>8040448</b>	<b>NEBC-D12G4-ES-3-S-D12G4-ET</b>	
			5 m	<b>8040449</b>	<b>NEBC-D12G4-ES-5-S-D12G4-ET</b>	
			10 m	<b>8040450</b>	<b>NEBC-D12G4-ES-10-S-D12G4-ET</b>	
			Straight plug, RJ45, 8-pin	1 m	<b>8040451</b>	<b>NEBC-D12G4-ES-1-S-R3G4-ET</b>
				3 m	<b>8040452</b>	<b>NEBC-D12G4-ES-3-S-R3G4-ET</b>
				5 m	<b>8040453</b>	<b>NEBC-D12G4-ES-5-S-R3G4-ET</b>
				10 m	<b>8040454</b>	<b>NEBC-D12G4-ES-10-S-R3G4-ET</b>
			Open end, 4-wire	5 m	<b>8040456</b>	<b>NEBC-LE4-ES-5-D12G4-ET</b>
<b>Plug socket for power supply</b>						
	Socket M12x1, 5-pin			<b>18324</b>	<b>FBSD-GD-9-5POL</b>	
<b>Connecting cable for power supply</b>						
	<ul style="list-style-type: none"> <li>• Socket M12x1, 5-pin</li> <li>• Plug M12x1, 5-pin</li> </ul>	Suitable for energy chains	5 m	<b>574321</b>	<b>NEBU-M12G5-E-5-Q8N-M12G5</b>	
			7.5 m	<b>574322</b>	<b>NEBU-M12G5-E-7.5-Q8N-M12G5</b>	
			10 m	<b>574323</b>	<b>NEBU-M12G5-E-10-Q8N-M12G5</b>	
			Standard	0.5 m	<b>570733</b>	<b>NEBU-M12W5-K-0.5-M12W5</b>
					<b>8003617</b>	<b>NEBU-M12G5-K-0.5-M12W5</b>
				2 m	<b>570734</b>	<b>NEBU-M12W5-K-2-M12W5</b>
					<b>8003618</b>	<b>NEBU-M12G5-K-2-M12W5</b>

## Datasheet CTEU-VN



The bus node handles communication between the valve terminal and a higher-order master for VARAN.

The module has basic diagnostic functions. It has 5 integrated LEDs for on-site display. Up to 32 byte inputs and 32 byte outputs are typically transmitted in the cyclic process image.

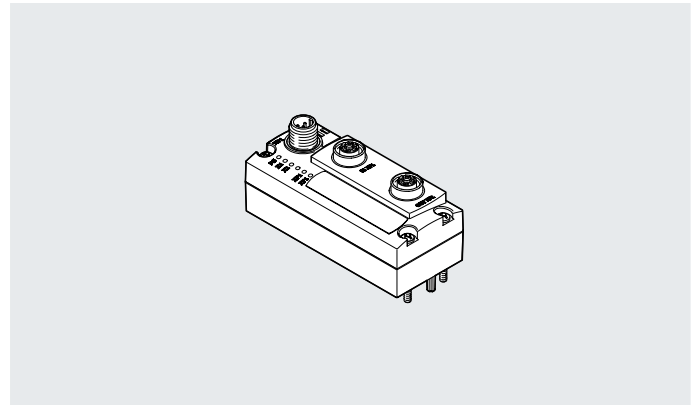
**Application**
**Bus connection**

The bus node provides two VARAN interfaces in line with IEEE802.3 that are galvanically isolated from the rest of the internal electronics.

The Ethernet cables are connected via a 4-pin, D-coded M12 socket.

The metal M12 push-in connectors of the ports on the bus node are connected directly to FE.

The connections are marked as IN XF1 and OUT XF2.

**Type of installation**
**Direct integration:**

In the case of direct mounting on an I-Port device, only one I-Port can be used. The connection with the device is established via a 5-pin, A-coded M12 socket.

**Decentralised installation of CTEL system with adapter CAPC:**

If the bus node is used on an adapter CAPC, the electrical connection

of both I-Ports is established via an 8-pin socket strip.

**General technical data**
**Fieldbus interface**

Protocol		VARAN
Transmission rate	[Mbps]	100
Type		Ethernet
Connection type		2 x socket
Connection technology		M12x1, D-coded to EN 61076-2-101
Number of pins/wires		4
Galvanic isolation		Yes
Internal cycle time		1 ms per 1 byte of user data
Function		Bus connection incoming/outgoing

**Inputs/outputs**

Max. address volume inputs	[byte]	32
Max. address volume for outputs	[byte]	32

## Datasheet CTEU-VN

General data		
Diagnostics		System diagnostics
		Undervoltage
		Communication error
Parameterisation		IO-Link mode
		Fail-safe response
Additional functions		FFT
		VARAN splitter
Configuration support		LASAL module
LED indicator		PS: Operating voltage for electronics and load supply
		X1: System status of module at I-Port 1
		X2: System status of module at I-Port 2
		XF1 AC: network data exchange, port 1
		XF1 LI: network active, port 1
Technical data – Electrics		
Nominal operating voltage	[V DC]	24
Operating voltage range	[V DC]	18 ... 30
Intrinsic current consumption at nominal operating voltage	[mA]	Typically 65
Max. power supply	[A]	4
Power supply		
Function		Electronics and load
Connection type		Plug
Connection technology		M12x1, A-coded to EN 61076-2-101
Number of pins/wires		5
Technical data – Mechanical components		
Type of mounting		On electrical connection block
		On electrical interface
Product weight	[g]	98
Grid dimension	[mm]	40
Dimensions W x L x H	[mm]	40 x 91 x 50
Materials		
Housing		PA
Note on materials		RoHS-compliant
		Contains paint-wetting impairment substances

## Datasheet CTEU-VN

Operating and environmental conditions		
Ambient temperature	[°C]	-5 ... +50
Storage temperature	[°C]	-20 ... +70
Corrosion resistance class CRC <sup>1)</sup>		2
CE marking (see declaration of conformity) <sup>3)</sup>		To EU EMC Directive <sup>2)</sup>
		To EU RoHS Directive
UKCA marking (see declaration of conformity) <sup>3)</sup>		To UK instructions for EMC <sup>2)</sup>
		To UK RoHS instructions
KC mark		KC EMC
Certification		RCM
Degree of protection		IP65/IP67
Note on degree of protection		In mounted state
		Unused connections sealed

1) Additional information: [www.festo.com/x/topic/kbk](http://www.festo.com/x/topic/kbk)

2) For information about the area of use, see the EC declaration of conformity at: [www.festo.com/catalogue/...](http://www.festo.com/catalogue/...) → Support/Downloads.

If the devices are subject to usage restrictions in residential, commercial or light-industrial environments, further measures for the reduction of the emitted interference may be necessary.

3) Additional information: [www.festo.com/catalogue/...](http://www.festo.com/catalogue/...) → Support/Downloads.

## Dimensions

Download CAD data → [www.festo.com](http://www.festo.com)

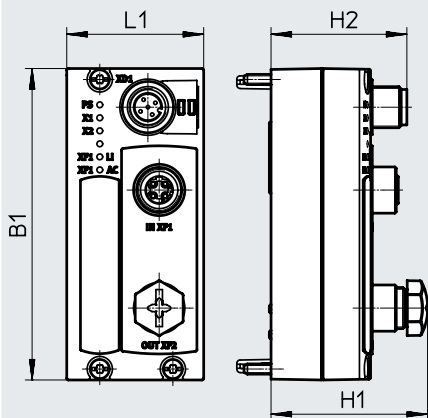



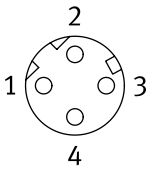
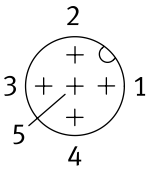
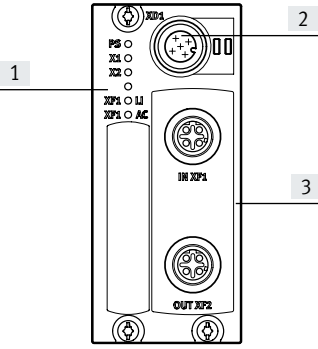

Type	B1	H1	H2	L1
CTEU-VN	91	45.7	39.7	40

### Datasheet CTEU-VN

Pin allocation		Pin		Allocation	Description
		IN XF1	OUT XF2		
<b>Ethernet interface, socket, M12, 4-pin</b>					
	1	2	TX+	Differential transmitter cable, positive signal	
	2	1	RX+	Differential receiver cable, positive signal	
	3	4	TX-	Differential transmitter cable, negative signal	
	4	3	RX-	Differential receiver cable, negative signal	
<b>Power supply, M12 plug, A-coded</b>					
	1	-	24V <sub>EL/SEN</sub>	Operating voltage supply PS I-Port devices	
	2	-	24V <sub>VAL/OUT</sub>	Load voltage supply PL I-Port devices	
	3	-	0V <sub>EL/SEN</sub>	Operating voltage supply PS I-Port devices	
	4	-	0V <sub>VAL/OUT</sub>	Load voltage supply PL I-Port devices	
	5	-	FE	Functional earth	
<b>Connection and display components</b>					
		<ul style="list-style-type: none"> <li>[1] Status LED (operating status/diagnostics)</li> <li>[2] Power supply</li> <li>[3] Bus interface incoming IN XF1/outgoing OUT XF2</li> </ul>			

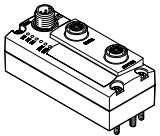
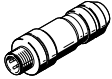
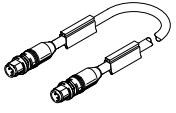

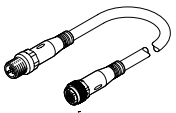
## CTEU-VN accessories

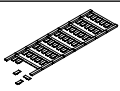
Ordering data		Part no.	Type		
<b>Bus node</b>					
	VARAN bus node	8087559	CTEU-VN		
<b>Plug for bus connection</b>					
	Plug M12x1, 4-pin, D-coded	543109	NECU-M-S-D12G4-C2-ET		
<b>Connecting cable for bus connection</b>					
	Straight plug, M12x1, 4-pin, D-coded	Straight plug, M12x1, 4-pin, D-coded	0.5 m	8040446	NEBC-D12G4-ES-0.5-S-D12G4-ET
			1 m	8040447	NEBC-D12G4-ES-1-S-D12G4-ET
			3 m	8040448	NEBC-D12G4-ES-3-S-D12G4-ET
			5 m	8040449	NEBC-D12G4-ES-5-S-D12G4-ET
			10 m	8040450	NEBC-D12G4-ES-10-S-D12G4-ET
		Straight plug, RJ45, 8-pin	1 m	8040451	NEBC-D12G4-ES-1-S-R3G4-ET
			3 m	8040452	NEBC-D12G4-ES-3-S-R3G4-ET
			5 m	8040453	NEBC-D12G4-ES-5-S-R3G4-ET
			10 m	8040454	NEBC-D12G4-ES-10-S-R3G4-ET
		Open end, 4-wire	5 m	8040456	NEBC-LE4-ES-5-D12G4-ET
<b>Plug for power supply</b>					
	Socket M12x1, 5-pin	18324	FBSD-GD-9-5POL		
<b>Connecting cable for power supply</b>					
	<ul style="list-style-type: none"> <li>Socket M12x1, 5-pin</li> <li>Plug M12x1, 5-pin</li> </ul>	Suitable for energy chains, straight socket	5 m	574321	NEBU-M12G5-E-5-Q8N-M12G5
			7.5 m	574322	NEBU-M12G5-E-7.5-Q8N-M12G5
			10 m	574323	NEBU-M12G5-E-10-Q8N-M12G5
		Standard, angled socket	0.5 m	570733	NEBU-M12W5-K-0.5-M12W5
				8003617	NEBU-M12G5-K-0.5-M12W5
			2 m	570734	NEBU-M12W5-K-2-M12W5
				8003618	NEBU-M12G5-K-2-M12W5
<b>Cover cap</b>					
	For plugging female threads M12x1	165592	ISK-M12		
<b>Identification holder</b>					
	5 frames with 40 pieces each	565306	ASLR-C-E4		

## Datasheet – CTEU-CP

The bus node handles communication between the valve terminal and a higher-order CPI master.

The module has basic diagnostic functions. It has 6 integrated LEDs for on-site display. A maximum of 4 byte inputs and 4 byte outputs are transmitted in the cyclic process image.

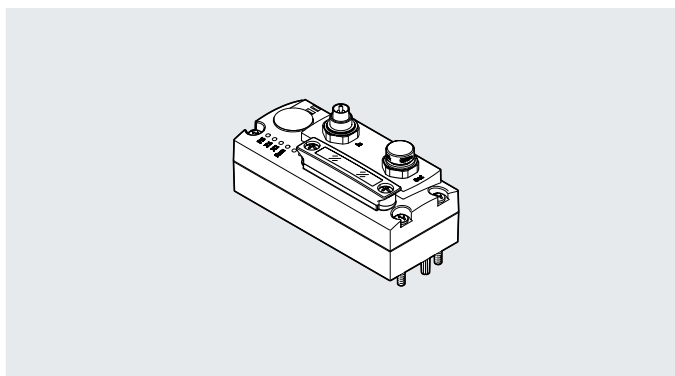

### Application

The bus node CTEU-CP provides two CPI interfaces.

The connections are marked as IN and OUT.

### Installation

#### Direct integration

- Mounting the bus node on an I-Port device, e.g. valve terminal
- One I-Port interface available (for internal communication)
- In this case, the connection with the device is established via a 5-pin, A-coded M12 flange socket.

#### Adapter CAPC

- Mounting the bus node on the adapter
- Two I-Port interfaces available on the adapter
- If the bus node is used on an adapter CAPC, the two I-Ports are connected electrically via an 8-pin socket strip.

#### Power supply

The power is supplied to the bus node and the connected I-Port devices via an M9 plug, 5-pin (In) and an M9 socket, 5-pin (Out) on the top side of the housing.

Both the plug and the socket have a metal thread.

### General technical data

#### Fieldbus interface

Protocol	CPI-B
	CP installation system
Transmission rate	[Mbps] 100
Fieldbus interface	Socket, M9x0.5, 5-pin
Internal cycle time	2 ms per 2 byte of user data

#### Inputs/outputs

Max. address volume inputs	[byte] 4
Max. address volume for outputs	[byte] 4

### Technical data – Electrics

Nominal operating voltage	[V DC] 24
Operating voltage range	[V DC] 18 ... 30
Intrinsic current consumption at nominal operating voltage	[mA] Typically 50
Max. power supply	[A] 3.4

## Datasheet – CTEU-CP

General data		
Device-specific diagnostics	System diagnostics	
	Undervoltage	
	Communication error	
Parameterisation	Diagnostic behaviour	
	Fail-safe response	
Control elements	DIL switches	
LED indicator	Product-specific	PS: Operating voltage for electronics and load supply
		X1: System status of module at I-Port 1
		X2: System status of module at I-Port 2
	Fieldbus-specific	RUN: Communication OK
Technical data – Mechanical components		
Product weight	[g]	105
Dimensions W x L x H	[mm]	40 x 91 x 50
Materials		
Housing	PA	
Note on materials	RoHS-compliant	
	Contains paint-wetting impairment substances	
Operating and environmental conditions		
Ambient temperature	[°C]	-5 ... +50
Storage temperature	[°C]	-20 ... +70
Corrosion resistance class CRC <sup>1)</sup>	2	
CE marking (see declaration of conformity) <sup>3)</sup>	To EU EMC Directive <sup>2)</sup>	
	To EU RoHS Directive	
UKCA marking (see declaration of conformity) <sup>3)</sup>	To UK instructions for EMC <sup>2)</sup>	
	To UK RoHS instructions	
KC mark	KC EMC	
Certification	c UL us - Listed (OL)	
	RCM	
Degree of protection	IP65/IP67	

1) Additional information: [www.festo.com/x/topic/kbk](http://www.festo.com/x/topic/kbk)

2) For information about the area of use, see the EC declaration of conformity at: [www.festo.com/catalogue/...](http://www.festo.com/catalogue/...) → Support/Downloads.

If the devices are subject to usage restrictions in residential, commercial or light-industrial environments, further measures for the reduction of the emitted interference may be necessary.

3) Additional information: [www.festo.com/catalogue/...](http://www.festo.com/catalogue/...) → Support/Downloads.

Datasheet – CTEU-CP

Dimensions

Download CAD data → [www.festo.com](http://www.festo.com)

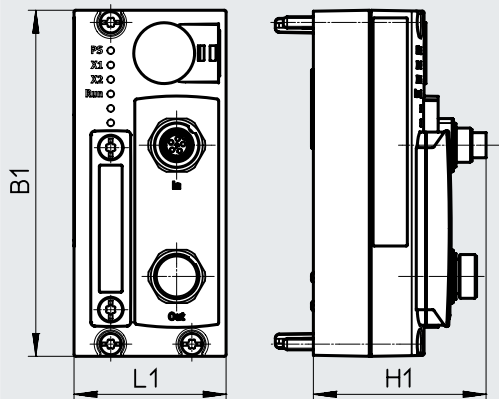

Type	L1	H1	B1
CTEU-CP	40	45.4	91

Pin allocation

	Pin	Allocation	Description
<b>Fieldbus interface M9, 5-pin</b>			
<b>Incoming</b>			
	1	24V <sub>EL/SEN</sub>	24 V DC operating voltage supply (PS) internal electronics and I-Port devices
	2	24V <sub>VAL/OUT</sub>	24 V DC load voltage supply (PL) I-Port devices
	3	0V <sub>EL/SEN</sub>	0 V operating voltage supply and load voltage supply
	4	CAN+	Received/transmitted data high
	5	CAN-	Received/transmitted data low
Thread	FE		Functional earth/shielding
<b>Outgoing</b>			
	1	24V <sub>EL/SEN</sub>	24 V DC operating voltage supply (PS) internal electronics and I-Port devices
	2	24V <sub>VAL/OUT</sub>	24 V DC load voltage supply (PL) I-Port devices
	3	0V <sub>EL/SEN</sub>	0 V operating voltage supply and load voltage supply
	4	CAN+	Received/transmitted data high
	5	CAN-	Received/transmitted data low
Thread	FE		Functional earth/shielding

Connection and display components

	<ul style="list-style-type: none"> <li>[1] Status LED (operating status/diagnostics)</li> <li>[2] DIL switch</li> <li>[3] Fieldbus interface incoming IN</li> <li>[4] Fieldbus interface outgoing OUT</li> </ul>
--	------------------------------------------------------------------------------------------------------------------------------------------------------------------------------------------------------------------

## Accessories – CTEU-CP

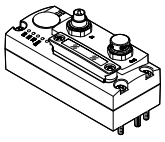
Ordering data			Part no.	Type
<b>Bus node</b>				
	Bus node CTEU-CP	For installation system CPI	<b>2149714</b>	<b>CTEU-CP</b>

## Datasheet – Interface CPX-CTEL

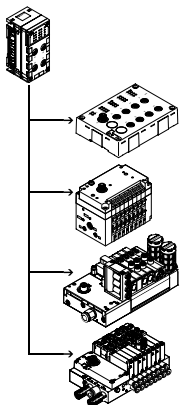

The electrical interface CPX CTEL master establishes the connection to modules of the CTEL/CTEU series that have an I-Port interface (device). The I/O data from the connected devices are transmitted to the connected CPX bus node and thus to the higher-order controller via fieldbus. A maximum of 4 devices can be connected to a CPX CTEL master via corresponding M12 interfaces.

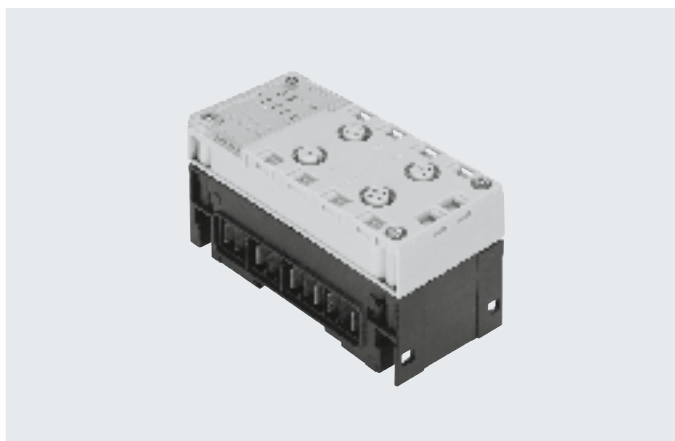

### Application

#### I-Port interface

As well as transmitting the communication data, the I-Port interfaces of a CPX CTEL master also transmit the power supply to the connected sensors

and the load supply to the valves (or outputs). Both circuits are supplied separately with 24 V, using a separate ground.

The connecting cables used must meet the increased requirements resulting from the dual function as signal cable and supply cable.

### Configuration example – CPX CTEL master with CTEL modules

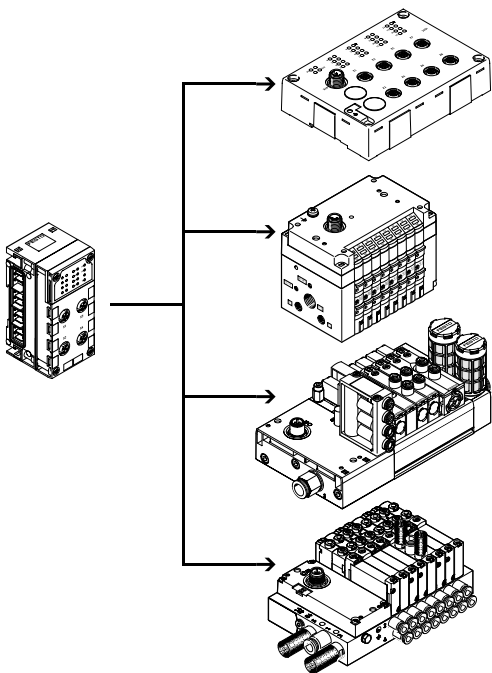

The CPX CTEL master provides 4 external I-Port interfaces, each of which can be connected with a device. I-Port is an interface for exchanging serial data for connecting decentralised modules or valve terminals from Festo. The I-Port interface is based on IO-Link and is compatible with it in certain areas. The connection type corresponds to a star topology. In other words, only one module or one valve terminal can be connected to each I-Port.

The restrictions compared to IO-Link® include:

- Permanently set baud rate of 230.4 kbps
- SIO mode is not supported
- Max. 32 bytes of input data and 32 bytes of output data
- Only one extract of the master commands is used
- Festo plug & work principle, configuration via IODD is not supported.

## Datasheet – Interface CPX-CTEL

### Implementation

The CPX CTEL master from Festo enables modules with an I-Port interface to be connected to a CPX system:

- Max. 4 devices with individual electronic protection
- Max. 64 inputs/64 outputs per I-Port interface
- The maximum length of a string is 20 m.

The following device variants are available:

- Input modules with 16 digital inputs (connection technology M8 3-pin and M12 5-pin)
- Valve terminals with I-Port interface (up to 48 solenoid coils, different valve functions)

The decentralised layout of the modules and valve terminals with I-Port en-

ables them to be mounted close to the cylinders and actuators or sensors to be controlled. This means that the compressed air supply lines and sensor cables used can be shortened, and it may be possible to use smaller valves, thereby saving costs. Several CPX CTEL masters can be combined in one CPX terminal, depending

on the address capacity of the bus node.

Example:

- CPX-FB13 (512 I/O)
- The maximum number of CPX CTEL masters is 2 (each with 256 I/O)

### Configuration

#### Settings

The precise number of the I/O bytes made available depends on the requirements of the connected devices or of the relevant selected operating mode.

The operating mode or preset configuration of the CPX CTEL master can be specified by the user.

Selecting the operating mode and setting the manual configuration takes place via the DIL switches. These DIL switches are not required during continuous operation and are only accessible in the disassembled state.

#### Manual configuration

In the case of manual configuration (tool change mode), the volume of inputs and outputs in the process image of the CPX system or of the higher-level fieldbus can be defined manually using the DIL switches.

The process image then always has the same scope, regardless of the connected devices.

The specified I/O length always applies to all four I-Ports (max. 8 bytes per I-Port).

#### Automatic configuration

In the case of automatic configuration, the I/O length for each I-Port is determined individually and this value is used to select the appropriate or next highest configuration preset.

### Power supply for I-Port devices

The CPX-CTEL master provides two separate power supplies for the connected devices:

- For operating the device and the inputs connected to it
- For the outputs and valves that are connected to the device

The power supply for the devices and the inputs is provided by the power

supply for the electronics and sensors of the CPX terminal.

The power supply for the outputs and valves is provided by the power supply for the valves of the CPX terminal.

The interlinking block with additional supply ensures a separate supply voltage for the valves and outputs. This

means it is possible to disconnect this supply voltage separately.

The valves and outputs of the connected I-Port devices can therefore be disconnected separately without disconnecting the devices.

## Datasheet – Interface CPX-CTEL

General technical data			
Type	CPX-CTEL-4-M12-5POL		
Protocol	I-Port		
Maximum address capacity	Outputs	[bit]	256
	Inputs	[bit]	256
I-Port connection	4x socket M12, 5-pin, A-coded		
Number of I-Port interfaces	4		
Maximum cable length			[m] 20
Internal cycle time			[ms] 1 per 8 bits of user data
Galvanic isolation	Channel – channel		No
	Channel – internal bus		Yes, with intermediate air supply
LED indicators	X1 ... 4 = Status of the I-Port interface 1 ... 4 PS = Electronic supply PL = Load supply -  - = Module error		
Diagnostics	<ul style="list-style-type: none"> <li>• Communication error</li> <li>• Module short circuit</li> <li>• Module-oriented diagnostics</li> <li>• Undervoltage</li> </ul>		
Parameterisation	<ul style="list-style-type: none"> <li>• Diagnostic behaviour</li> <li>• Failsafe per channel</li> <li>• Forcing per channel</li> <li>• Idle mode per channel</li> <li>• Module parameters</li> <li>• Tool change mode</li> </ul>		
Additional functions	Tool change mode		
Control elements	DIL switches		
Operating voltage	Nominal width	[V DC]	24 (reverse polarity protected)
	Permissible range	[V DC]	18 ... 30
	Power failure buffering	[ms]	10
Intrinsic current consumption at nominal operating voltage			[mA] Typically 65
Max. power supply per channel			[A] 4x 1.6
Max. residual current of outputs per channel			[A] 4x 1.6
Degree of protection to EN 60529	IP65/IP67		
Temperature range	Operating	[°C]	-5 ... +50
	Storage/transport	[°C]	-20 ... +70
Materials	Reinforced PA, PC		
Note on materials	RoHS-compliant		
Grid dimension			[mm] 50
Dimensions (including interlinking block) W x L x H			[mm] 50 x 107 x 55
Product weight			[g] 110

 - **Note**

Please observe the general limits and guidelines for the system when configuring the electric modules.



## Datasheet – Interface CPX-CTEL

### Connection and display components

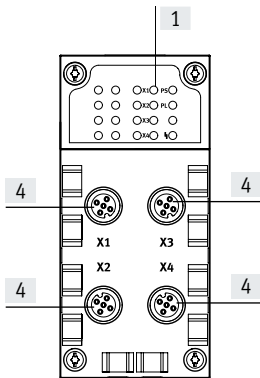

- [1] Status LEDs for I-Port interfaces
- [2] CPX-specific status LEDs
- [3] Holders for inscription labels (IBS 6x10)
- [4] I-Port interfaces for up to 4 devices

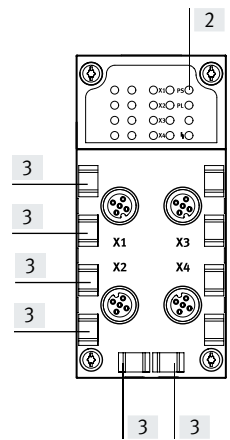

### Pin allocation – I-Port interface/IO-Link

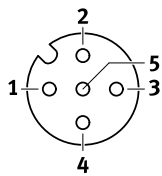

Pin	Allocation	Description
1	24V <sub>EL/SEN</sub>	Operating voltage supply (electronics, sensors/inputs)
2	24V <sub>VAL/OUT</sub>	Load voltage supply (valves/outputs)
3	0V <sub>EL/SEN</sub>	Operating voltage supply (electronics, sensors/inputs)
4	C/Q	Data communication
5	0V <sub>VAL/OUT</sub>	Load voltage supply (valves/outputs)

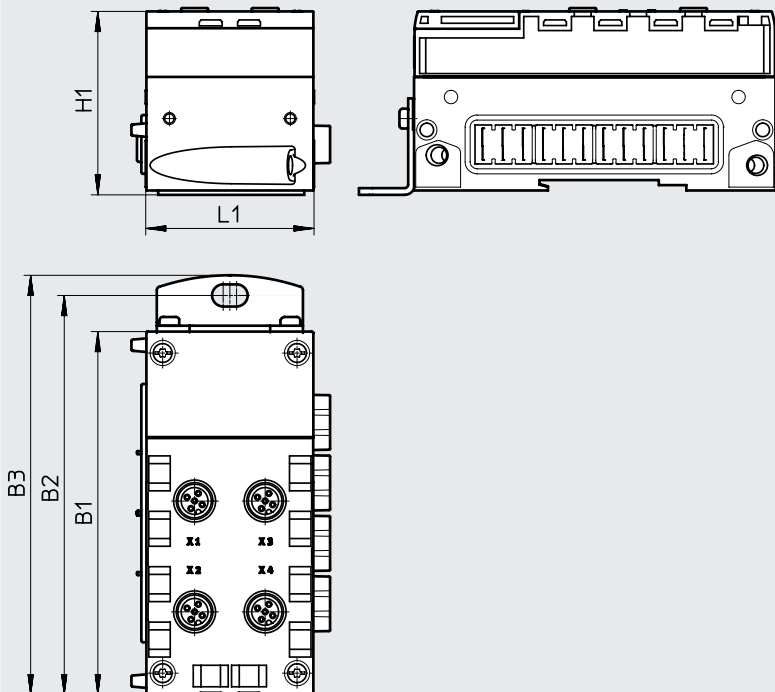

### Dimensions

Download CAD data → [www.festo.com](http://www.festo.com)

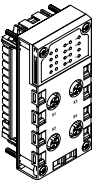

Type	B1	B2	B3	H1	L1
CPX-CTEL-4-M12-5POL	108.1	118.9	124.9	55.1	50

## Accessories – Interface CPX-CTEL

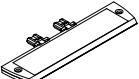
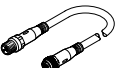
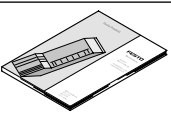
Ordering data				
Designation		Part no.	Type	
<b>CPX CTEL master</b>				
	Interface for a maximum of 4 I/O modules and valve terminals with I-Port interface (devices)		1577012 CPX-CTEL-4-M12-5POL	
<b>Bus connection</b>				
	Cover cap M12		165592 ISK-M12	
	Inscription label holder for connection block		536593 CPX-ST-1	
<b>Connecting cable</b>				
	Straight – angled	Suitable for energy chains	5 m	574321 NEBU-M12G5-E-5-Q8N-M12G5
			7.5 m	574322 NEBU-M12G5-E-7.5-Q8N-M12G5
			10 m	574323 NEBU-M12G5-E-10-Q8N-M12G5
	Angled – angled	Standard	0.5 m	570733 NEBU-M12W5-K-0.5-M12W5
				8003617 NEBU-M12G5-K-0.5-M12W5
			2 m	570734 NEBU-M12W5-K-2-M12W5
8003618 NEBU-M12G5-K-2-M12W5				
<b>User documentation</b>				
	User documentation for CPX CTEL master	German	574600	P.BE-CPX-CTEL-DE
		English	574601	P.BE-CPX-CTEL-EN
		Spanish	574602	P.BE-CPX-CTEL-ES
		French	574603	P.BE-CPX-CTEL-FR
		Italian	574604	P.BE-CPX-CTEL-IT

## Datasheet – Interface CPX-CTEL-2

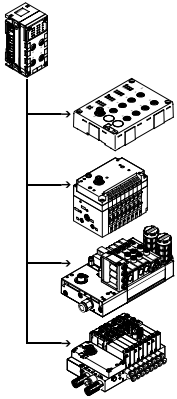

The electrical interface CPX CTEL master establishes the connection to modules of the CTEL/CTEU series that have an I-Port interface (device). The I/O data from the connected devices are transmitted to the connected CPX bus node and thus to the higher-order controller via fieldbus.

A maximum of two IO-Link devices can be connected to an electrical interface CPX-CTEL-2-... via the corresponding M12 interfaces.



### Application

#### IO-Link interface

The communication system IO-Link is used to exchange serial data from decentralised function modules (devices) at the field level.

The electrical interface CPX-CTEL-2-... provides two external IO-Link inter-

faces, each of which can be connected to a device.

The connection type corresponds to a star topology, which means that only one device can be connected to each port.

The address space that the module makes available and assigns accordingly in the CPX system can be configured according to various presets. Selecting the operating mode and setting the manual configuration takes place via the DIL switches. These DIL

switches are not required during continuous operation and are only accessible in the disassembled state.

### Constraints

The interfaces (ports) of electrical interface CPX-CTEL-2-... support the connection of IO-Link devices with few limitations.

- The process data length of the inputs and outputs is limited to 16 bytes each per port
- The driver strength on the C/Q line is limited to 250 mA
- SIO mode is not supported

The electrical interface CPX-CTEL-2-... provides two separate power supplies for the connected devices:

- For operating the device and the inputs connected to it
- For the outputs and valves that are connected to the device

The power supply for the devices and the inputs is provided by the power

supply for the electronics and sensors of the CPX terminal.

The power supply for the outputs and valves is provided by the power supply for the valves of the CPX terminal.

The interlinking block with additional supply ensures a separate supply voltage for the valves and outputs. This

means it is possible to disconnect this supply voltage separately.

The valves and outputs of the connected I-Port devices can therefore be disconnected separately without disconnecting the devices.

## Datasheet – Interface CPX-CTEL-2

General technical data			
Type	CPX-CTEL-2-M12-5POL-LK		
Protocol	IO-Link, master version V 1.0		
Max. address volume	Outputs	[bit]	256
	Inputs	[bit]	256
I-Port connection	2x socket M12, 5-pin, A-coded		
Number of IO-Link interfaces	2		
Maximum cable length			[m] 20
Internal cycle time			[ms] 1 per 8 bits of user data
Galvanic isolation	Channel – channel	No	
	Channel – internal bus	Yes, with intermediate air supply	
LED indicators	X1 ... 2 = Status of the IO-Link interface 1 ... 2 PS = Electronic supply PL = Load supply -  - = Module error		
Diagnostics	<ul style="list-style-type: none"> <li>• Communication error</li> <li>• Module short circuit</li> <li>• Module-oriented diagnostics</li> <li>• Undervoltage</li> </ul>		
Parameterisation	<ul style="list-style-type: none"> <li>• Diagnostic behaviour</li> <li>• Failsafe per channel</li> <li>• Forcing per channel</li> <li>• Idle mode per channel</li> <li>• Module parameters</li> </ul>		
Control elements	DIL switches		
Operating voltage	Nominal width	[V DC]	24 (reverse polarity protected)
	Permissible range	[V DC]	18 ... 30
	Power failure buffering	[ms]	10
Intrinsic current consumption at nominal operating voltage			[mA] Typically 65
Max. power supply per channel			[A] 2x 1.6
Max. residual current of outputs per channel			[A] 2x 1.6
Degree of protection to EN 60529	IP65, IP67		
Temperature range	Operating	[°C]	-5 ... +50
	Storage/transport	[°C]	-20 ... +70
Materials	Reinforced PA, PC		
Note on materials	RoHS-compliant		
Grid dimension			[mm] 50
Dimensions (including interlinking block) W x L x H			[mm] 50 x 107 x 55
Product weight			[g] 110

 **Note**

Please observe the general limits and guidelines for the system when configuring the electric modules.

## Datasheet – Interface CPX-CTEL-2

### Connection and display components

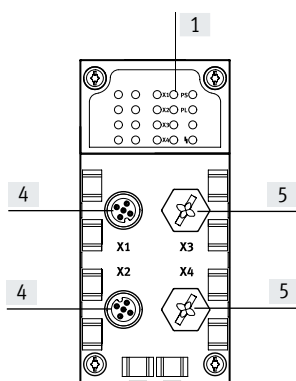

- [1] Status LEDs for I-Port interfaces
- [2] CPX-specific status LEDs
- [3] Holders for inscription labels (IBS 6x10)
- [4] IO-Link interfaces for up to 2 devices
- [5] Unused connections

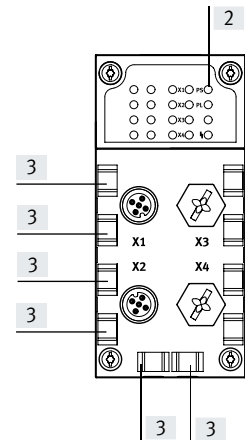

### Pin allocation – IO-Link interface

Terminal allocation	Pin	Signal	Control element
	1	24 V <sub>SEN</sub>	24 V DC supply voltage for electronics and inputs
	2	24 V <sub>VAL</sub>	24 V DC load voltage supply for valves and outputs
	3	0 V <sub>SEN</sub>	0 V DC supply voltage for electronics and sensors
	4	C/Q I-Port	Communication signal C/Q, data transmission line
	5	0 V <sub>VALVES</sub>	0 V DC load voltage supply for valves and outputs



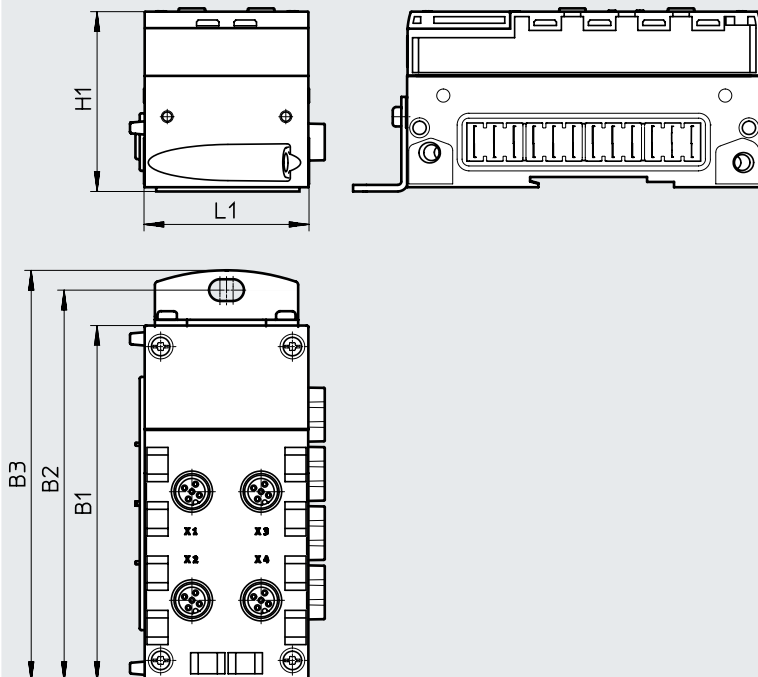

### Dimensions

Download CAD data → [www.festo.com](http://www.festo.com)

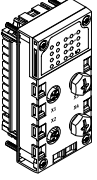

Type	B1	B2	B3	H1	L1
CPX-CTEL-2-M12-5POL-LK	108.1	118.9	124.9	55.1	50

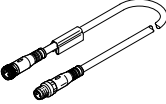
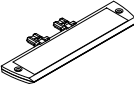
## Accessories – Interface CPX-CTEL-2

Ordering data				
Designation			Part no.	Type
<b>CPX CTEL master, IO-Link</b>				
	Interface for max. 2 I/O modules and valve terminals with IO-Link interface (devices)		<b>2900543</b>	<b>CPX-CTEL-2-M12-5POL-LK</b>
<b>Bus connection</b>				
	Cover cap	M12	<b>165592</b>	<b>ISK-M12</b>
	Connecting cable M12-M12, 5-pin, straight plug-straight socket	5 m	<b>574321</b>	<b>NEBU-M12G5-E-5-Q8N-M12G5</b>
		7.5 m	<b>574322</b>	<b>NEBU-M12G5-E-7.5-Q8N-M12G5</b>
		10 m	<b>574323</b>	<b>NEBU-M12G5-E-10-Q8N-M12G5</b>
	Inscription label holder for connection block		<b>536593</b>	<b>CPX-ST-1</b>
<b>User documentation</b>				
	User documentation for CPX CTEL master	German	<b>8034115</b>	<b>P.BE-CPX-CTEL-LK-DE</b>
		English	<b>8034116</b>	<b>P.BE-CPX-CTEL-LK-EN</b>
		Spanish	<b>8034117</b>	<b>P.BE-CPX-CTEL-LK-ES</b>
		French	<b>8034118</b>	<b>P.BE-CPX-CTEL-LK-FR</b>
		Italian	<b>8034119</b>	<b>P.BE-CPX-CTEL-LK-IT</b>
		Swedish	<b>8034120</b>	<b>P.BE-CPX-CTEL-LK-ZH</b>

## Datasheet – Valve terminal VTSA

IO-Link interface for communication between a valve terminal VTSA and an IO-Link master. It activates a valve terminal VTSA with up to 32 solenoid coils on max. 16 valve positions.

The connection to a higher-order controller can be achieved by:

- Connection to an I-Port master from Festo (CPX-CTEL)
- Direct mounting of a bus node CTEU
- Connection to an IO-Link master (in IO-Link mode)

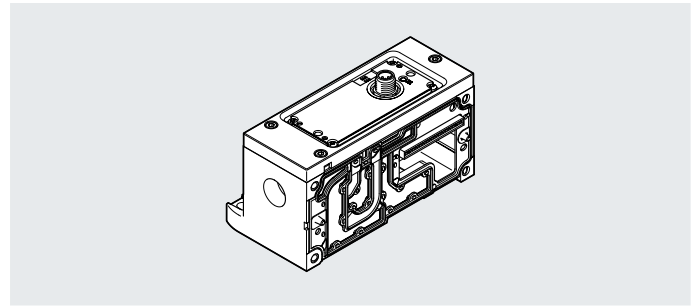

### General technical data

Types of communication		IO-Link
IO-Link, connection technology		Device, 5-pin
IO-Link, protocol version		Device V 1.1
IO-Link, communication mode		COM2.
IO-Link, port class		Device B
IO-Link, number of ports		Device 1
IO-Link, proc. data width OUT		Device 1-4 byte
IO-Link, minimum cycle time		Device 3.2 ms
Baud rate	[kbps]	38.4
Intrinsic current consumption of electronics/sensors	[mA]	Typ. 30
Intrinsic current consumption of load	[mA]	Typ. 30
Max. number of solenoid coils		32
Max. no. of valve positions		16
Residual ripple	[Vss]	4
Polarity reversal protection		Separate for power system (PS) and power load (PL)
Nominal conductor cross section	[mm <sup>2</sup> ]	1
Max. cable length	[m]	20
Nominal operating voltage DC	[V]	24
Product weight	[g]	690

### Materials

Note on materials	RoHS-compliant
PWIS conformity	VDMA24364-B2-L

### Operating and environmental conditions

Corrosion resistance class CRC <sup>1)</sup>	2
----------------------------------------------	---

<sup>1)</sup> Additional information: [www.festo.com/x/topic/kbk](http://www.festo.com/x/topic/kbk)

### LED indicator

	Colour	Status	Function
Status LED X1	Red/green	Off	–
		Static green	Normal operating status
		Flashing green	Communication error
		Flashing red/green	Load supply error (undervoltage or no load supply)
		Static red	Load supply error and communication error

## Datasheet – Valve terminal VTSA

### Connection and display components

VABA-S6-1-PT

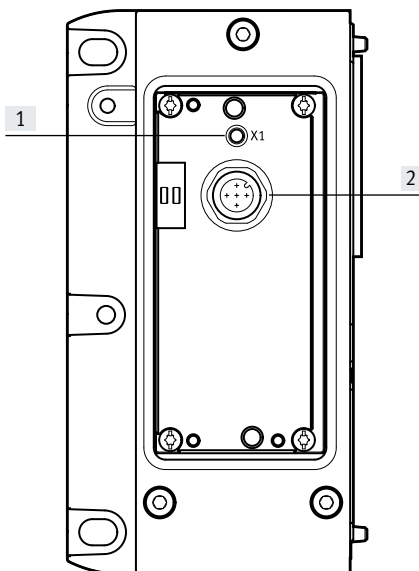

- [1] Status LED
- [2] I-Port interface/IO-Link

### Pin allocation – I-Port interface/IO-Link

	Pin	Allocation	Description
	1	24V <sub>EL/SEN</sub>	Supply, power system
	2	24V <sub>VAL/OUT</sub>	Load supply, power load
	3	0V <sub>EL/SEN</sub>	Supply, power system
	4	C/Q	Communication signal
	5	0V <sub>VAL/OUT</sub>	Load supply, power load

### Dimensions

Download CAD data → [www.festo.com](http://www.festo.com)



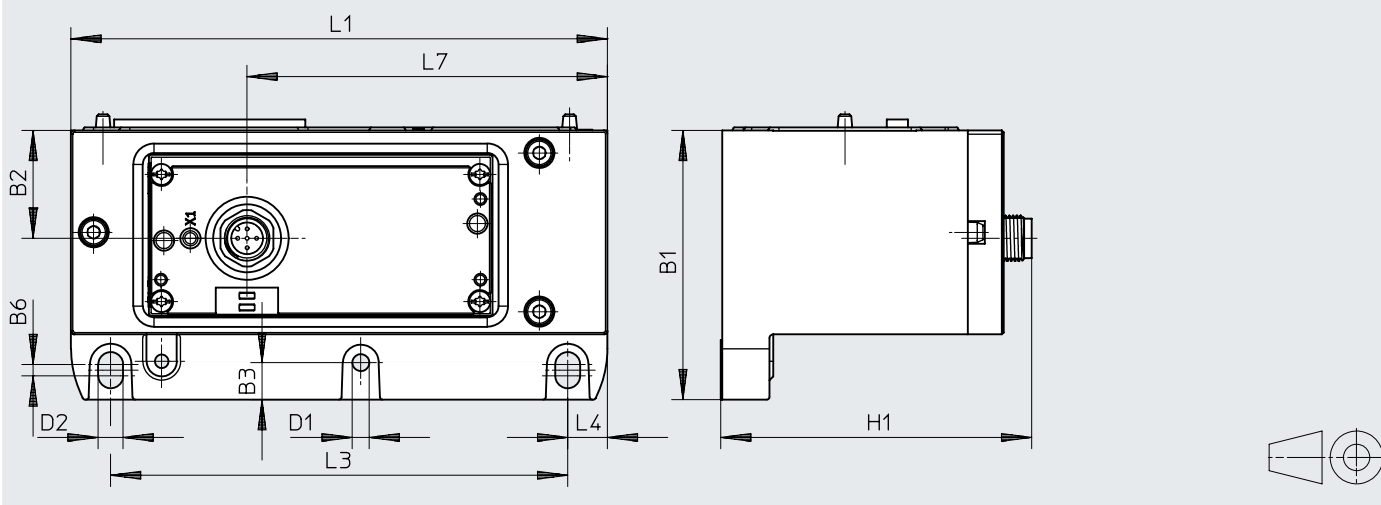

Outlet on top



Type	B1	B2	B3	B6	D1 ∅	D2 ∅	H1	L1	L3	L4	L7
VABA-S6-1-PT	71.3	28.6	9.8	3	4.5	6.6	82.3	142	121	10.5	95.4

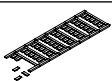
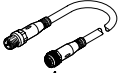

## Datasheet – Valve terminal VTSA

Accessories					
	Description	Part no.	Type		
	Electrical interface for IO-Link/I-Port	8152353	VABA-S6-1-PT		
<b>Connection technology for IO-Link</b>					
	T-adapter M12, 5-pin for IO-Link and load voltage supply	171175	FB-TA-M12-5POL		
<b>Straight plug, for IO-Link</b>					
	Straight plug, M12, 5-pin (for T-adapter)	175487	SEA-M12-5GS-PG7		
<b>Y distributor for IO-Link</b>					
	Y-distributor with cable on controller side, M12x1 A-coded, for IO-Link	8091516	NEDU-L1R2-M12G5-M12LE-1R		
<b>Inscription label for IO-Link</b>					
	40 pieces in frame	565306	ALSR-C-E4		
<b>Connecting cable</b>					
	Straight – angled	Suitable for energy chains	5	574321	NEBU-M12G5-E-5-Q8N-M12G5
			7.5	574322	NEBU-M12G5-E-7.5-Q8N-M12G5
			10	574323	NEBU-M12G5-E-10-Q8N-M12G5
	Angled – angled	Standard	0.5 m	570733	NEBU-M12W5-K-0.5-M12W5
				8003617	NEBU-M12G5-K-0.5-M12W5
			2 m	570734	NEBU-M12W5-K-2-M12W5
				8003618	NEBU-M12G5-K-2-M12W5

## Datasheet – Valve terminals CPV

-  Flow rate  
 CPV10: up to 400 l/min  
 CPV14: up to 800 l/min

-  Valve width  
 CPV10: 10 mm  
 CPV14: 14 mm

-  Voltage  
 24 V DC

I-Port interface for communication between a valve terminal CPV and an I-Port master. It activates a valve terminal CPV with up to 16 solenoid coils on max. 8 valve positions.

The connection to a higher-order controller can be achieved by:

- Connection to an I-Port master from Festo (CPX-CTEL)
- Direct mounting of a bus node CTEU
- Connection to an IO-Link master (in IO-Link mode)

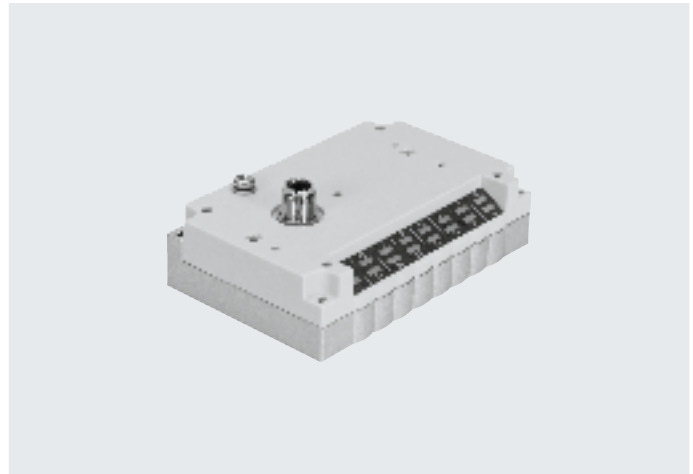
**General technical data**

Protocol			IO-Link/I-Port
IO-Link	Connection technology		5-pin
	Protocol		V 1.0
	Communication mode		COM2 (38.4 kBaud), COM3 (230 kBaud)
	Port type		B
	Number of ports		1
	Process data length OUT	[bit]	16
	Minimum cycle time	[ms]	3.2
Baud rate	[kbps]	38.4/230.4	
Maximum number of valve positions	8		
Nominal operating voltage	[V DC]	24	
Nominal load voltage	[V DC]	24	
Operating voltage range	Electronics/sensors	[V DC]	18 ... 30
	Load voltage	[V DC]	21.6 ... 26.4
Intrinsic current consumption	Operating voltage	[mA]	35
	Load voltage	[mA]	700
Reverse polarity protection	For operating voltage		
Diagnostics	Undervoltage in load voltage supply		
LED indicator	Bus-specific	1 communication status	
	Product-specific	16 valve status	

**Materials**

Housing	Aluminium
	PA
Seal	NBR
Thread	Brass
Cover	PA
Note on materials	RoHS-compliant

**Operating and environmental conditions**

Mounting position	Any	
Degree of protection to EN 60529	IP65 (when fully plugged in or fitted with protective cover)	
Ambient temperature	[°C]	-5 ... +50
Storage temperature	[°C]	-20 ... +70
Relative humidity	[%]	93 (non-condensing)
CE marking (see declaration of conformity)	To EU EMC Directive <sup>1)</sup>	
KC marking	KC EMC	

1) For information about the area of use, see the EC declaration of conformity at: [www.festo.com/catalogue/...](http://www.festo.com/catalogue/...) → Support/Downloads.  
 If the devices are subject to usage restrictions in residential, commercial or light-industrial environments, further measures for the reduction of the emitted interference may be necessary.

## Datasheet – Valve terminals CPV

ATEX	
ATEX category gas	II 3G
Ex-ignition protection type gas	Ex ec IIC Gc X
Explosion protection certification outside the EU	EPL Gc (GB)

### Connection and display components

CPV10	CPV14
-------	-------

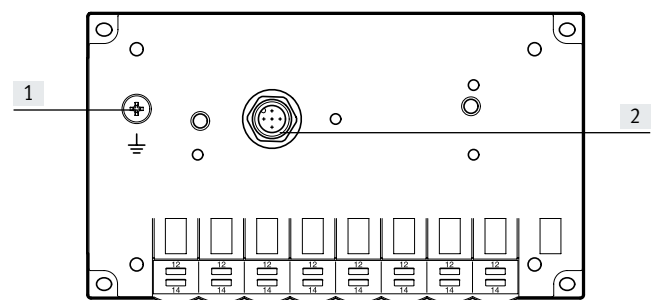
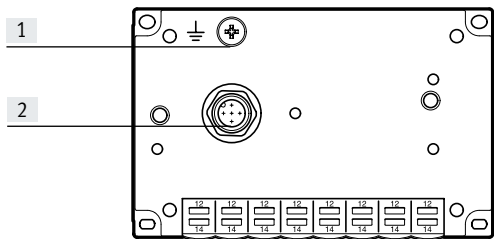

[1] Earthing screw

[2] I-Port interface/IO-Link

[1] Earthing screw

[2] I-Port interface/IO-Link

Pin allocation – I-Port interface/IO-Link			
	Pin	Allocation	Description
	1	24V <sub>EL/SEN</sub>	Operating voltage supply (electronics, sensors/inputs)
	2	24V <sub>VAL/OUT</sub>	Load voltage supply (valves/outputs)
	3	0V <sub>EL/SEN</sub>	Operating voltage supply (electronics, sensors/inputs)
	4	C/Q	Data communication
	5	0V <sub>VAL/OUT</sub>	Load voltage supply (valves/outputs)

### Dimensions

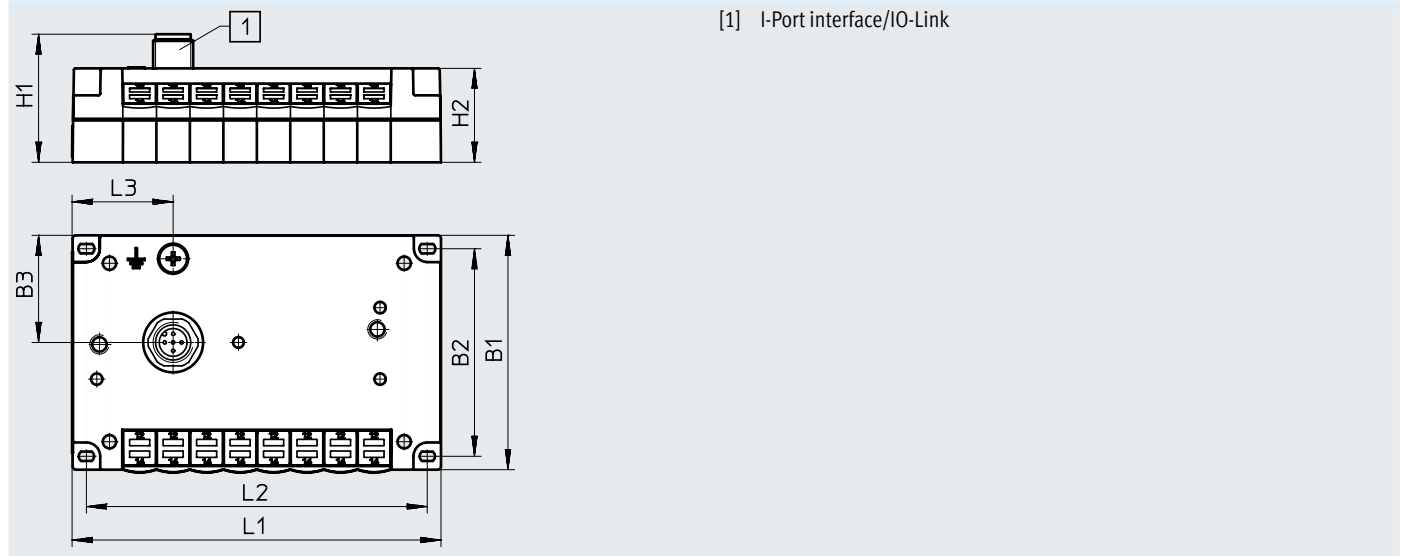

Download CAD data → [www.festo.com](http://www.festo.com)



[1] I-Port interface/IO-Link

Type	B1	B2	B3	H1	H2	L1	L2	L3
CPV10-GE-PT-8	71	62	32	38.3	26.2	110	101.8	30.2
CPV14-GE-PT-8	89	78	32.4	38.3	26.2	152	142	56.5

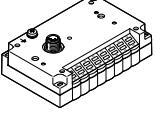
## Accessories – Valve terminals CPV

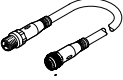
Ordering data				Part no.	Type
<b>I-Port bus node</b>					
	Bus node with I-Port interface/IO-Link and 8 valve positions (maximum 8 double solenoid valves)	CPV10	Device ID: 0x 000410	108.5 g	<b>1565761</b> CPV10-GE-PT-8
		CPV14	Device ID: 0x 000510	200 g	<b>1564984</b> CPV14-GE-PT-8
<b>Connection technology for IO-Link</b>					
	T-adapter M12, 5-pin for IO-Link and load voltage supply			<b>171175</b>	FB-TA-M12-5POL
	Straight plug, M12, 5-pin (for T-adapter)			<b>175487</b>	SEA-M12-5GS-PG7
<b>Connecting cable</b>					
	Straight – angled	Suitable for energy chains	5	<b>574321</b>	NEBU-M12G5-E-5-Q8N-M12G5
			7.5	<b>574322</b>	NEBU-M12G5-E-7.5-Q8N-M12G5
			10	<b>574323</b>	NEBU-M12G5-E-10-Q8N-M12G5
	Angled – angled	Standard	0.5 m	<b>570733</b>	NEBU-M12W5-K-0.5-M12W5
				<b>8003617</b>	NEBU-M12G5-K-0.5-M12W5
				<b>570734</b>	NEBU-M12W5-K-2-M12W5
Straight – angled		2 m	<b>8003618</b>	NEBU-M12G5-K-2-M12W5	

## Datasheet – Valve terminals MPA-L

- 	Flow rate
	VMPA1: up to 360 l/min
	VMPA14: up to 670 l/min
	VMPA2: up to 700 l/min

- 	Valve width
	VMPA1: 10 mm
	VMPA14: 14 mm
	VMPA2: 20 mm

- 	Voltage
	24 V DC

I-Port interface for communication between a valve terminal MPA-L and an I-Port master. It activates a valve terminal MPA-L with up to 32 solenoid coils on max. 32 valve positions.

The connection to a higher-order controller can be achieved by:

- Connection to an I-Port master from Festo (CPX-CTEL)
- Direct mounting of a bus node CTEU
- Connection to an IO-Link master (in IO-Link mode)

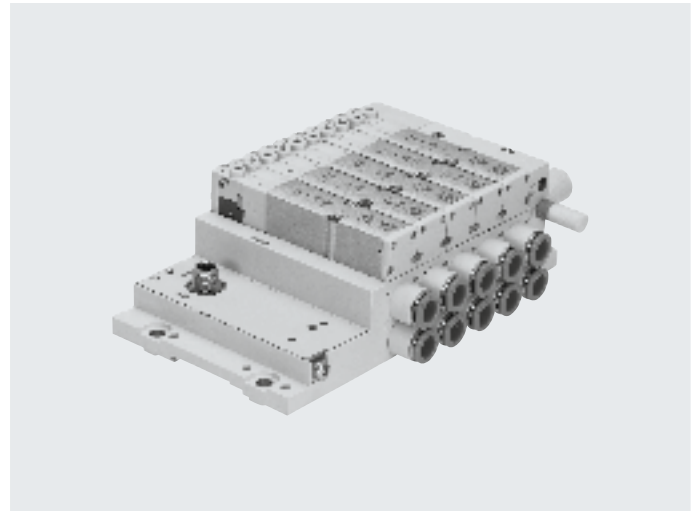

General technical data			
Protocol		IO-Link/I-Port	
IO-Link	Connection technology	5-pin	
	Protocol	V 1.0	
	Communication mode	COM2 (38.4 kBaud), COM3 (230 kBaud)	
	Port type	B	
	Number of ports	1	
	Process data length OUT [bit]	8 ... 32	
	Minimum cycle time [ms]	3.2	
Baud rate	[kbps]	38.4/230.4	
Operating pressure	[bar]	-0.9 ... 10	
Pilot pressure	[bar]	3 ... 8	
Nominal operating voltage	[V DC]	24	
Intrinsic current consumption	Operating voltage	[mA]	30
	Load voltage	[mA]	30
Reverse polarity protection		For operating voltage	
Diagnostics		Undervoltage in load voltage supply	
LED indicator		1 communication status	

Materials	
End plate	Reinforced PPA
Note on materials	RoHS-compliant

Operating and environmental conditions		
Mounting position		Any
Ambient temperature	[°C]	-5 ... +50
Storage temperature	[°C]	-20 ... +40
Corrosion resistance class CRC <sup>1)</sup>		3

1) Additional information: [www.festo.com/x/topic/kbk](http://www.festo.com/x/topic/kbk)

## Datasheet – Valve terminals MPA-L

### Connection and display components

VMPAL-EPL-IPO32

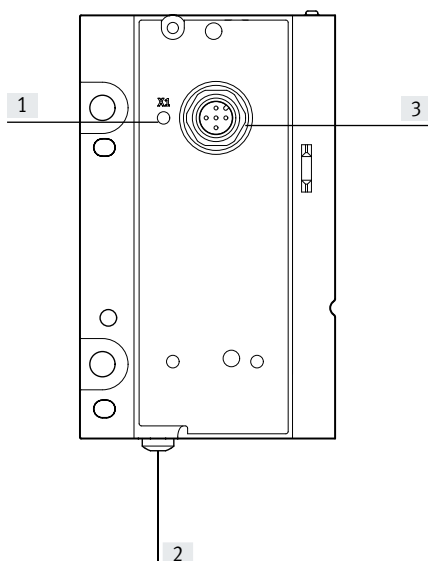

- [1] Status LED
- [2] Earthing screw
- [3] I-Port interface/IO-Link

### Pin allocation – I-Port interface/IO-Link

	Pin	Allocation	Description
	1	24V <sub>EL/SEN</sub>	Operating voltage supply (electronics, sensors/inputs)
	2	24V <sub>VAL/OUT</sub>	Load voltage supply (valves/outputs)
	3	0V <sub>EL/SEN</sub>	Operating voltage supply (electronics, sensors/inputs)
	4	C/Q	Data communication
	5	0V <sub>VAL/OUT</sub>	Load voltage supply (valves/outputs)

### Dimensions

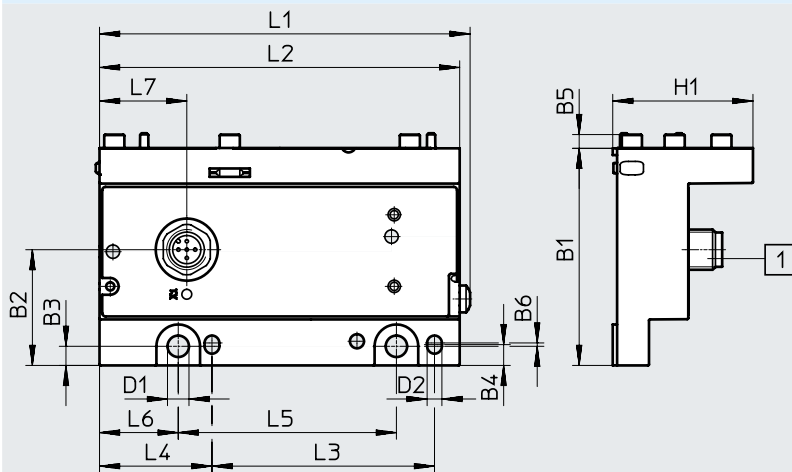

Download CAD data → [www.festo.com](http://www.festo.com)



[1] I-Port interface/IO-Link

Type	B1	B2	B3	B4	B5	B6	D1	D2	H1	L1	L2	L3	L4	L5	L6	L7
VMPAL-EPL-IPO32	64.8	34.5	5.7	6.2	4	1	6.4	4.5	41.8	110	107	66.3	33.5	65	23.5	26

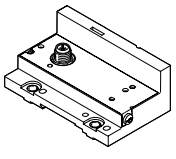
## Accessories – Valve terminals MPA-L

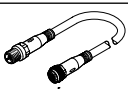
Ordering data				Part no.	Type	
<b>I-Port bus node</b>						
	Bus node with I-Port interface/IO-Link and up to 32 valve positions (maximum 16 double solenoid valves)	Device ID: 0x 000620	170 g	<b>575667</b>	<b>VMPAL-EPL-IP032</b>	
<b>Connection technology for IO-Link</b>						
	T-adapter M12, 5-pin for IO-Link and load voltage supply			<b>171175</b>	<b>FB-TA-M12-5POL</b>	
	Straight plug, M12, 5-pin (for T-adapter)			<b>175487</b>	<b>SEA-M12-5GS-PG7</b>	
<b>Connecting cable</b>						
	Straight – angled	Suitable for energy chains	5 m	<b>574321</b>	<b>NEBU-M12G5-E-5-Q8N-M12G5</b>	
			7.5 m	<b>574322</b>	<b>NEBU-M12G5-E-7.5-Q8N-M12G5</b>	
			10 m	<b>574323</b>	<b>NEBU-M12G5-E-10-Q8N-M12G5</b>	
	Angled – angled	Standard	0.5 m		<b>570733</b>	<b>NEBU-M12W5-K-0.5-M12W5</b>
					<b>8003617</b>	<b>NEBU-M12G5-K-0.5-M12W5</b>
					<b>570734</b>	<b>NEBU-M12W5-K-2-M12W5</b>
					<b>8003618</b>	<b>NEBU-M12G5-K-2-M12W5</b>
Straight – angled		2 m		<b>570734</b>	<b>NEBU-M12W5-K-2-M12W5</b>	
				<b>8003618</b>	<b>NEBU-M12G5-K-2-M12W5</b>	

## Datasheet – Input modules CTSL

### Function

Digital input modules make it easier to connect proximity switches or other 24 V DC sensors (inductive, capacitive, etc.).

Plugs with double allocation are separated using a DUO plug or DUO cable.

### Area of application

- Input modules for 24 V DC sensor signals
- M12 connection technology
- Display of the input statuses for each input signal via an assigned LED
- Operating voltage supply 24 V DC for all connected sensors
- Diagnostic LED for short circuit/overload of sensor supply
- Labelling options on all sides with large, hinged inscription label
- Earthing plate and H-rail mounting already integrated

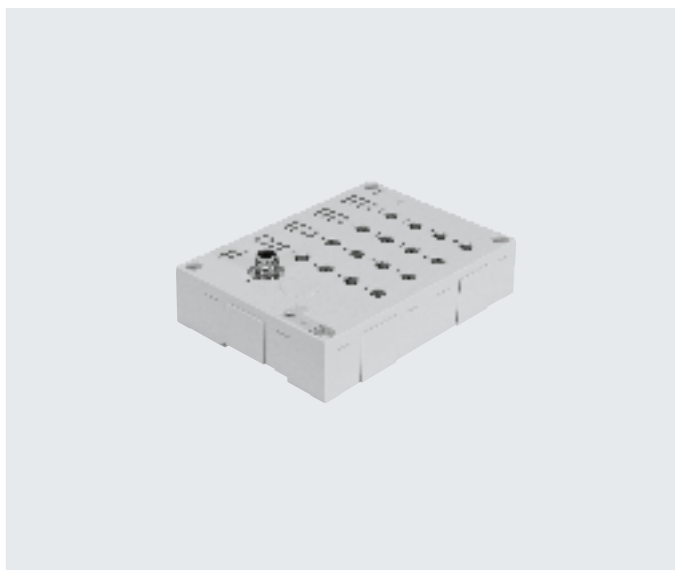

General technical data			
Type	CTSL-D-16E-M8-3		CTSL-D-16E-M12-5
Electrical connection	16x socket, M8, 3-pin		8x socket, M12, 5-pin
Protocol	IO-Link/I-Port		
IO-Link	Connection technology		5-pin
	Protocol		V 1.0
	Communication mode		COM2 (38.4 kBaud), COM3 (230 kBaud)
	Port type		B
	Number of ports		1
	Process data length OUT	[bit]	16
	Minimum cycle time	[ms]	3.2
	Device ID	[ms]	0x 700410
Baud rate	[kbps]	38.4/230.4	
Max. number of inputs	16		
Nominal operating voltage	[V DC]	24	
Operating voltage range	[V DC]	18 ... 30	
Current consumption at nominal operating voltage of logic circuit	[mA]	Max. 35	
Max. residual current per module	[mA]	1.2	
Reverse polarity protection	For operating voltage		
Fuse protection (short circuit)	Internal electronic fuse protection for each group		
Galvanic isolation between channels	No		
Switching level	Signal 0	[V]	≤5
	Signal 1	[V]	≥11
Input debounce time	[ms]	0.5 (3 ms, 10 ms, 20 ms parameterisable)	
Input characteristics	IEC 1131-T2		
Switching logic at inputs	PNP (positive switching)		
LED indicator	Bus-specific		X20: I-Port/IO-Link
	Product-specific		1 operating voltage
			16 channel status
			2 group diagnostics



## Datasheet – Input modules CTSL

Materials	
Housing	Reinforced PA
Cover	Reinforced PA
Note on materials	RoHS-compliant
PWIS conformity	VDMA24364-B2-L
Product weight	[g] 250
Dimensions	(W x L x H) [mm] 143 x 103 x 32
Operating and environmental conditions	
Type of mounting	Either via H-rail or via through-hole
Degree of protection to EN 60529	IP65/IP67 (when fully plugged in or fitted with protective cap)
Ambient temperature	[°C] -5 ... +50
Storage temperature	[°C] -20 ... +70
Corrosion resistance class CRC <sup>1)</sup>	2
CE marking (see declaration of conformity) <sup>2)</sup>	To EU EMC Directive <sup>3)</sup>
	To EU RoHS Directive
UKCA marking (see declaration of conformity) <sup>2)</sup>	To UK instructions for EMC <sup>3)</sup>
	To UK RoHS instructions
KC mark	KC EMC
Certification	RCM
	c UL us - Listed (OL)
Certificate-issuing authority	UL E239998

1) Additional information: [www.festo.com/x/topic/kbk](http://www.festo.com/x/topic/kbk)

2) Additional information: [www.festo.com/catalogue/...](http://www.festo.com/catalogue/...) → Support/Downloads.

3) For information about the area of use, see the EC declaration of conformity at: [www.festo.com/catalogue/...](http://www.festo.com/catalogue/...) → Support/Downloads.

If the devices are subject to usage restrictions in residential, commercial or light-industrial environments, further measures for the reduction of the emitted interference may be necessary.

## Datasheet – Input modules CTSL

### Connection and display components

CTSL-D-16E-M8-3

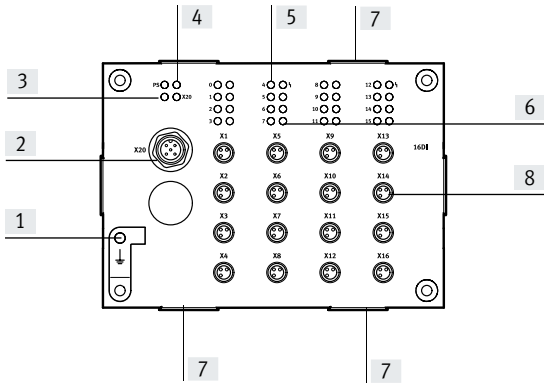

- [1] Earth terminal
- [2] I-Port interface/IO-Link
- [3] Status LED for power supply (PS)
- [4] Status LED for I-Port (X20)
- [5] Status LEDs for inputs (status indication, green)
- [6] Status LED (group) for short circuit/overload of sensor supply (red)
- [7] Holder for inscription label holder ASCF-H-E2
- [8] Sensor connections  
(1 input per socket)

#### Pin allocation – I-Port interface/IO-Link

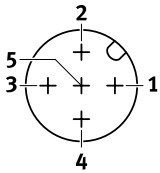

Pin	Allocation	Description
1	24V <sub>EL/SEN</sub>	Operating voltage supply (electronics, sensors/inputs)
2	–	–
3	0V <sub>EL/SEN</sub>	Operating voltage supply (electronics, sensors/inputs)
4	C/Q	Data communication
5	–	–

#### Pin allocation – Sensor connections CTSL-D-16E-M8-3

Terminal allocation

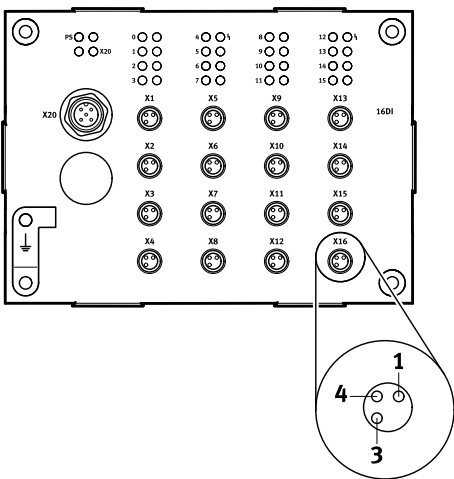

Pin	Allocation	Description
1	24 V	Operating voltage 24 V
3	0 V	Operating voltage 0 V
4	Ix*	Sensor signal

\* Ix = Input x

## Datasheet – Input modules CTSL

### Connection and display components

CTSL-D-16E-M12-5

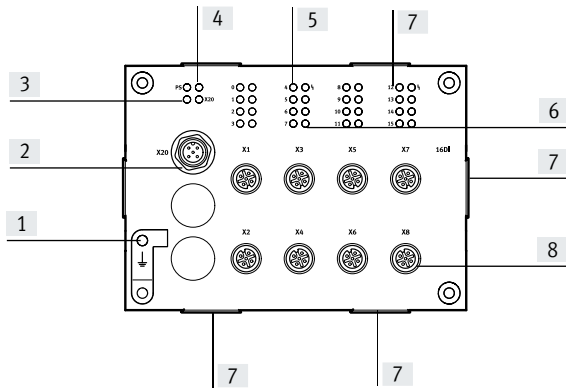

- [1] Earth terminal
- [2] I-Port interface/IO-Link
- [3] Status LED for power supply (PS)
- [4] Status LED for I-Port (X20)
- [5] Status LEDs for inputs (status indication, green)
- [6] Status LED (group) for short circuit/overload of sensor supply (red)
- [7] Holder for inscription label holder ASCF-H-E2
- [8] Sensor connections  
(2 inputs per socket)

#### Pin allocation – I-Port interface/IO-Link

	Pin	Allocation	Description
	1	24V <sub>EL/SEN</sub>	Operating voltage supply (electronics, sensors/inputs)
	2	–	–
	3	0V <sub>EL/SEN</sub>	Operating voltage supply (electronics, sensors/inputs)
	4	C/Q	Data communication
	5	–	–

#### Pin allocation – Sensor connections CTSL-D-16E-M12-5

Terminal allocation	Pin	Allocation	Description
	1	24 V	Operating voltage 24 V
	2	Ix+1*	Sensor signal
	3	0 V	Operating voltage 0 V
	4	Ix*	Sensor signal
	5	FE	Functional earth

\* Ix = Input x

### Datasheet – Input modules CTSL

**Dimensions**

Download CAD data → [www.festo.com](http://www.festo.com)

CTSL-D-16E-M8-3

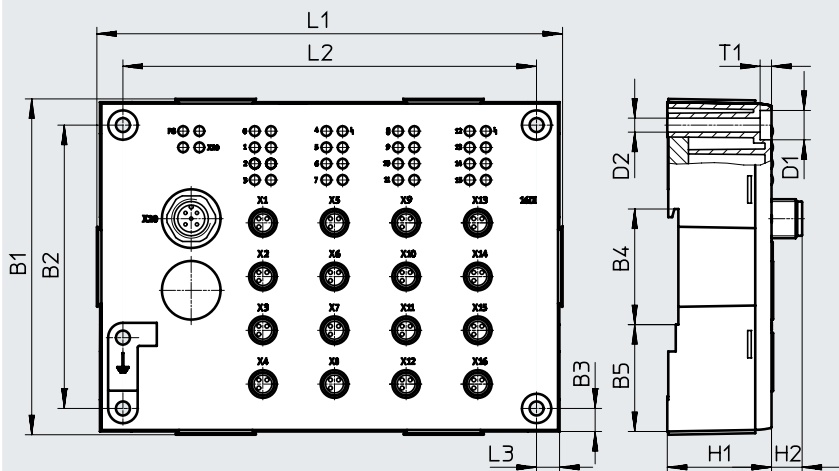

CTSL-D-16E-M12-5

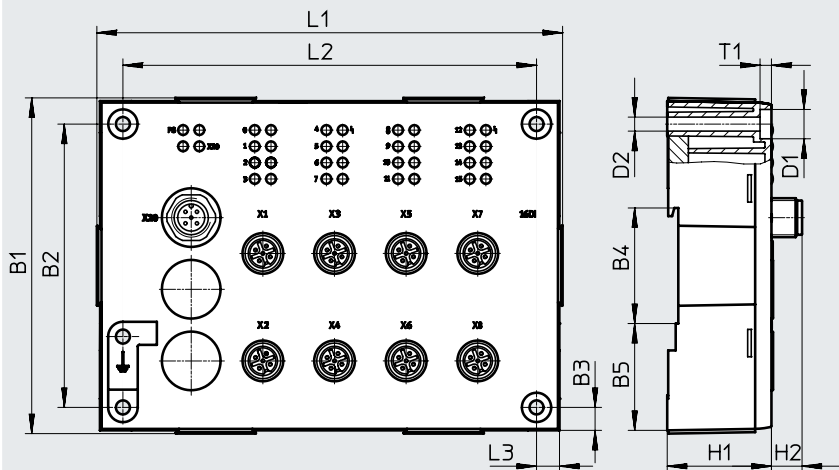

Type	B1	B2	B3	B4	B5	D1	D2	H1	H2	L1	L2	L3	T1
CTSL-D-16E	103	87	7	35.5	32.8	9	4.3	32	9.4	143	127	7	3.5

## Accessories – Input modules CTSL

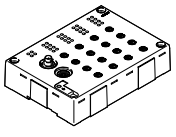
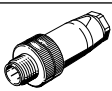
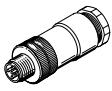
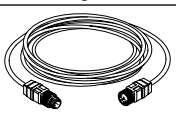
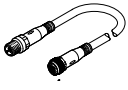
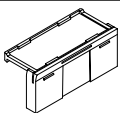
Ordering data		Part no.	Type
Designation			
<b>Input modules</b>			
	16 sensor connections M8, 3-pin, single allocation	1387363	CTSL-D-16E-M8-3
	8 sensor connections M12, 5-pin, double allocation	1387359	CTSL-D-16E-M12-5
<b>Plug</b>			
	Straight plug, M12	5-pin, PG7	175487 SEA-M12-5GS-PG7
		4-pin, PG7	18666 SEA-GS-7
		4-pin, for cable diameter 2.5 mm <sup>2</sup>	192008 SEA-4GS-7-2.5
	Straight plug, M8	3-pin, solderable	18696 SEA-GS-M8
		3-pin, screw-in	192009 SEA-3GS-M8-S
	Plug for 2 cables, M12, PG11	4-pin	18779 SEA-GS-11-DUO
		5-pin	192010 SEA-5GS-11-DUO
<b>Connecting cables</b>			
	Connecting cable, M12, 4-pin, straight plug-straight socket	2.5 m	539052 NEBU-M12G4-K-2.5-M12G4 <sup>1)</sup>
		5.0 m	539052 NEBU-M12G4-K-5-M12G4 <sup>1)</sup>
	Connecting cable, M8, 3-pin, straight plug-straight socket	0.5 m	539052 NEBU-M8G3-K-0.5-M8G3 <sup>1)</sup>
		1 m	539052 NEBU-M8G3-K-1-M8G3 <sup>1)</sup>
		2.5 m	539052 NEBU-M8G3-K-2.5-M8G3 <sup>1)</sup>
		5 m	539052 NEBU-M8G3-K-5-M8G3 <sup>1)</sup>
	Straight – angled	5 m	574321 NEBU-M12G5-E-5-Q8N-M12G5
		7 m	574322 NEBU-M12G5-E-7.5-Q8N-M12G5
		10 m	574323 NEBU-M12G5-E-10-Q8N-M12G5
	Angled – angled	0.5 m	570733 NEBU-M12W5-K-0.5-M12W5
	Straight – angled		8003617 NEBU-M12G5-K-0.5-M12W5
	Angled – angled	2 m	570734 NEBU-M12W5-K-2-M12W5
Straight – angled		8003618 NEBU-M12G5-K-2-M12W5	
<b>Inscription label holders</b>			
	Inscription label holders for EL modules, bag of 10	547473	ASCF-H-E2

1) Modular product, more information → Internet: nebu

### Example of a valve terminal VTUG with I-Port interface

Dimensions – Example of a valve terminal with I-Port interface

Download CAD data → [www.festo.com](http://www.festo.com)

Size 10

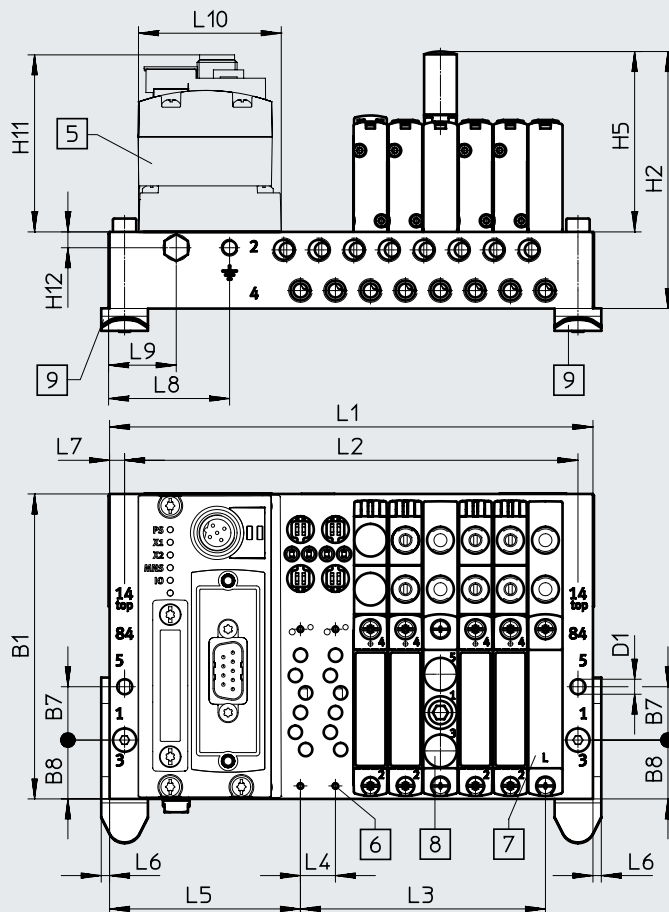
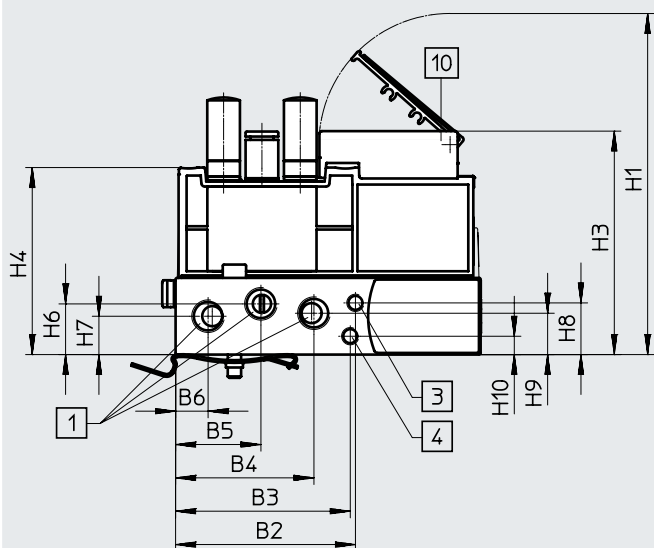

- [1] Ports 1, 3 and 5: G1/8 (at both ends)
- [3] Ports 12/14: M5 (at both ends)
- [4] Ports 82/84: M5 (at both ends)

- [5] CTEU-CANopen
- [6] Valves/cover plates/supply plates – mounting on sub-base: M2

- [7] Cover plate
- [8] Supply plate, ports 1, 3 and 5: M7

- [9] H-rail mounting
- [10] Inscription label holder

## Example of a valve terminal VTUG with I-Port interface

Type	Number of valve positions	Size 10																
		B1	B2	B3	B4	B5	B6	B7	B8	D1 $\varnothing$	H1	H2	H3	H4	H5	H6	H7	H8
VABM	4-24	91.5	54	52.4	41.5	25.6	9.8	16	17.7	4.5	102.3	77.1	67	56.1	54.1	15.2	11.5	15.5

Type	Number of valve positions	Size 10										
		H9	H10	H11	H12	L4	L5	L6	L7	L8	L9	L10
VABM	4-24	12.4	5.5	54.8	4.8	10.5	57.3	2.5	4.5	36	20	42.5

Type	Number of valve positions	Size 10		
		L1	L2	L3
VABM	4	103	94	31.5
	5	113.5	104.5	42
	6	124	115	52.5
	7	134.5	125.5	63
	8	145	136	73.5
	9	155.5	146.5	84
	10	166	157	94.5
	12	187	178	115.5
	16	229	220	157.5
	20	271	262	199.5
24	313	304	241.5	