

Modular electrical terminal CPX

FESTO

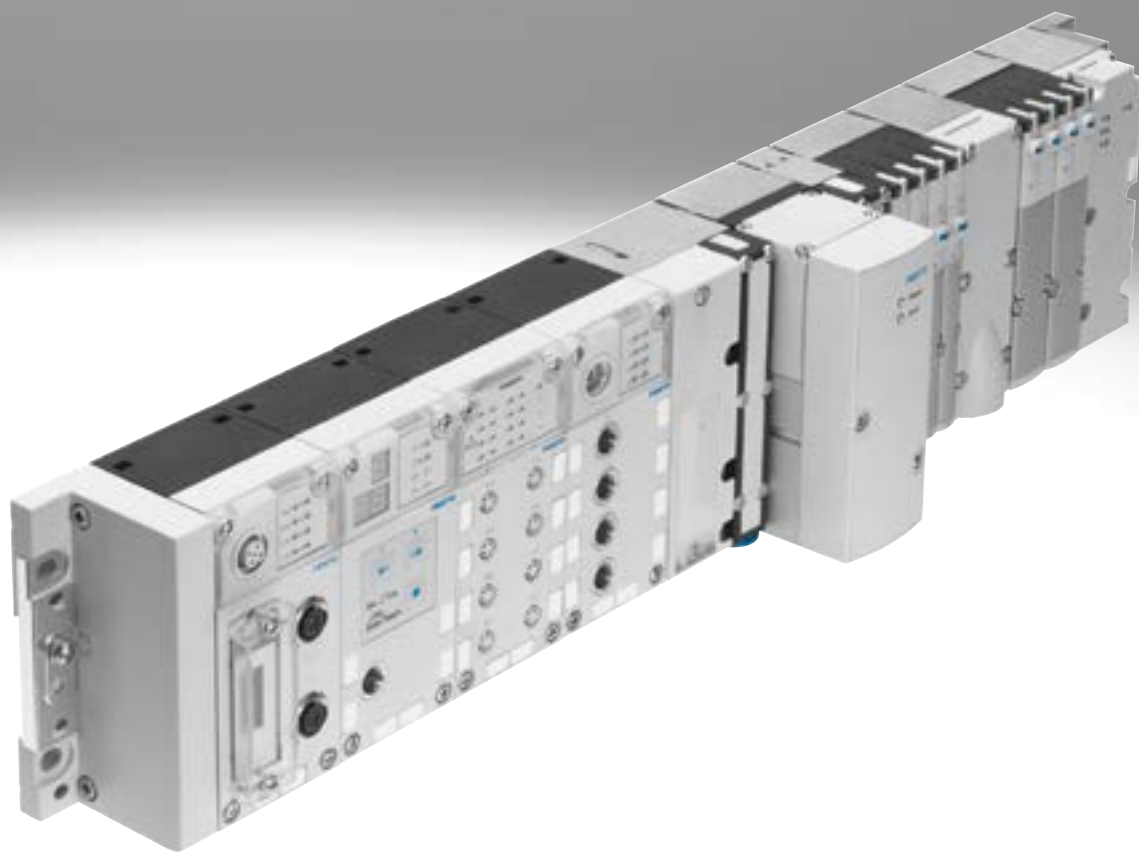

Key features



Key features

Installation concept

- Choice of several valve terminals for different applications:
 - MPA-S
 - MPA-L
 - VTSA/VTSA-F/VTSA-F-CB
- Economical from the smallest configuration up to the maximum number of modules
- Up to 9 electrical input/output modules plus bus node and pneumatic interface/electronics modules for valves
- Extensive range of functions and connection options for the electrical modules
- Choice of connection technology for technically and economically optimised connections
- Can be used as a dedicated remote I/O module

Electrics

- High operating voltage tolerance ($\pm 25\%$)
- Choice of M12x1, M18, 7/8" or AIDA push-pull connection for power supply
- Open to all fieldbus protocols and Ethernet
- Optional function and technology modules for preprocessing
- IT services and TCP/IP such as remote maintenance, remote diagnostics, web server, SMS and e-mail alert
- Digital inputs and outputs, 4-/8-/16-way, optionally available with individual channel diagnostics
- Analogue inputs and outputs, 2-way/4-way, optionally with HART protocol
- Pressure inputs
- Temperature inputs
- Controllers for pneumatic and electric axes
- IP65 and IP67 or IP20

Mounting

- Wall or H-rail mounting, also on mobile units
- Conversions/extensions are possible at any time, individual linking with CPX metal design
- Modular system offering a range of configuration options
- Fully assembled and tested unit
- Reduced costs for selection, ordering, assembly and commissioning thanks to the central CPX terminal
- Choice of pneumatic components for optimised control chain
- Decentralised, subordinate CPI installation system improves cycle times by up to 30%
- Safe and convenient earthing thanks to earthing plate

Operation

- Fast troubleshooting thanks to an extensive selection of LEDs (some of which are multi-coloured) on the bus node and on all I/O modules
- Supports module and channel-oriented diagnostics
- Fieldbus/Ethernet remote diagnostics
- Innovative diagnostic support with integrated web server/web monitor or maintenance tool with USB adapter for PC
- Optimised commissioning thanks to parameterisable functions
- Reliable servicing with connection blocks and modules that are quick to replace without changing the wiring

Key features

Pneumatic variants of the CPX terminal

The electrical terminal CPX is a modular peripheral system for valve terminals.

The system is specifically designed so that the valve terminal can be adapted to suit a wide range of different applications.

The modular system design lets you configure the number of valves, inputs and additional outputs to suit the application.

With valve terminal – decentralised

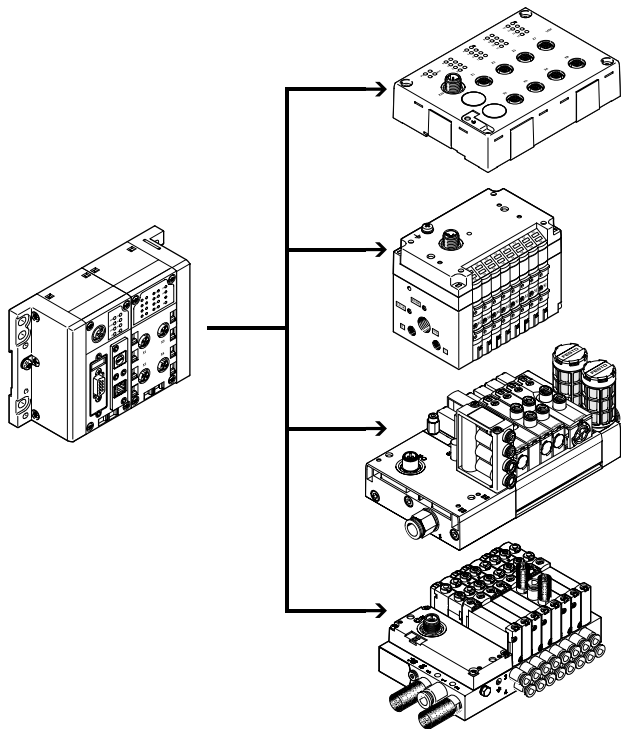

With valve terminal MPA-S – centralised

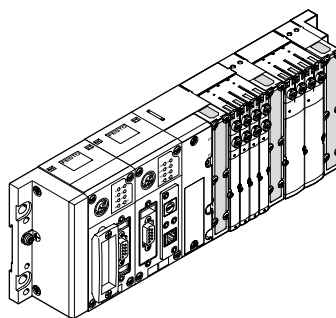

With valve terminal VTSA – centralised

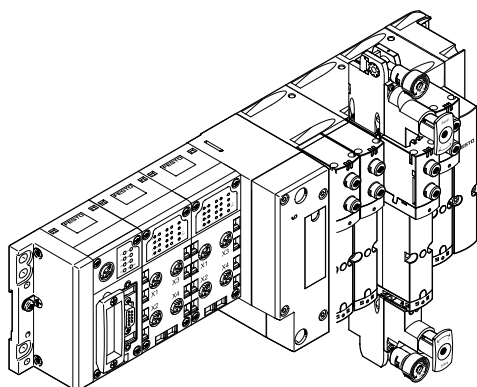

In metal design with valve terminal VTSA – centralised

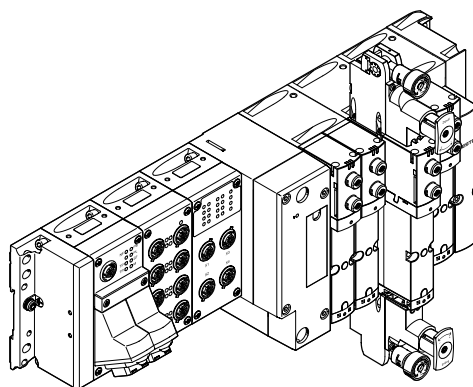

Key features

Variants of the CPX terminal controller (with bus node, without preprocessing)

Bus node

Different bus nodes are used for integration in the control systems of various manufacturers.

The CPX terminal can therefore be operated on over 90% of the most commonly used fieldbus systems:

- PROFIBUS DP
- PROFINET
- DeviceNet
- CANopen
- CC-Link

Integration in universal networks based on Ethernet opens up new possibilities. Faster data transmission, real-time capability and above all additional IT services such as file transfer, web server, web monitor as integrated website in the CPX terminal, text message/e-mail alerts, etc. open up a wide range of synergies.

These include standardised and universal communication technology

across all areas, including operating level, management level and field level in the production environment, with protection to IP65, IP67.

The following protocols are supported:

- EtherNet/IP
- Modbus/TCP
- PROFINET
- POWERLINK
- EtherCAT
- Sercos III

Bus node

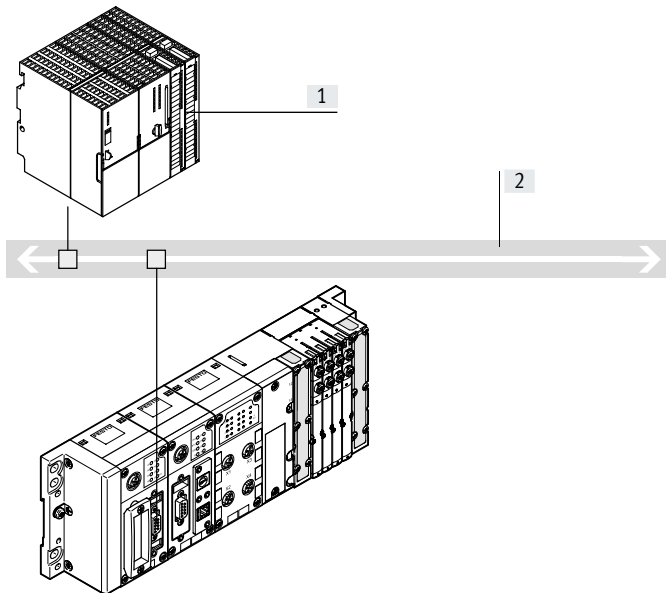

- [1] Higher-order controller (PLC)
[2] Fieldbus

- Communication with the higher-order controller via fieldbus
- No preprocessing
- Fieldbus protocol dependent on CPX bus node used
- More than 90 I/Os, depending on bus node used

Industrial Ethernet bus node

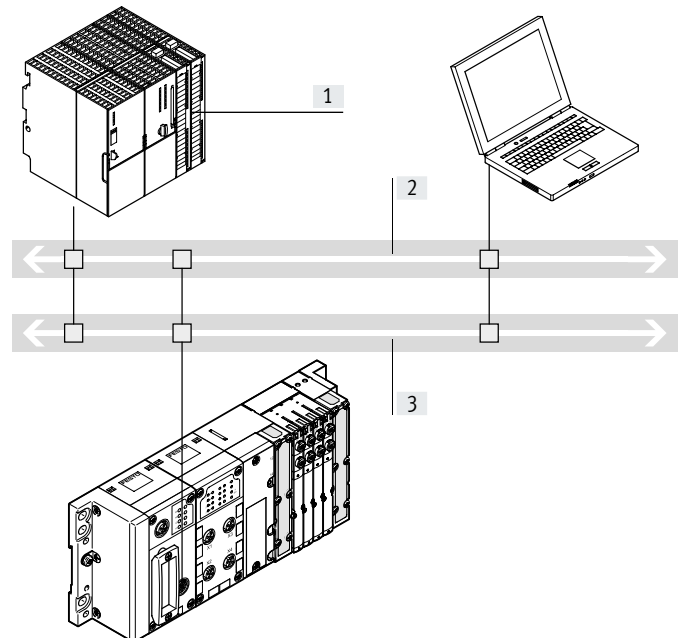

- [1] Higher-order controller (PLC)
[2] Fieldbus
[3] IT services:

- Web
- Email
- Data transmission

- Connection to a higher-order controller directly via EtherNet/IP, Modbus/TCP, POWERLINK, EtherCAT or PROFINET
- No preprocessing
- Monitoring via Ethernet and web applications
- More than 300 I/Os

Note

Every electrical interface can be combined with an appropriate number of I/O modules and/or pneumatic components, depending on its address capacity.

Likewise, every pneumatic variant of the CPX terminal can be operated with every electrical interface variant.

Key features

Variants of the CPX terminal controller (with preprocessing in the control block)

Control block

The optional front end controllers CPX-CEC enable simultaneous access via Ethernet, in parallel with a bus node, as well as stand-alone preprocessing.

Access via Modbus/TCP and EasyIP is also possible.

Commissioning, programming, and diagnostics using the Festo software tool FST with hardware configurator.

With control block in stand-alone mode

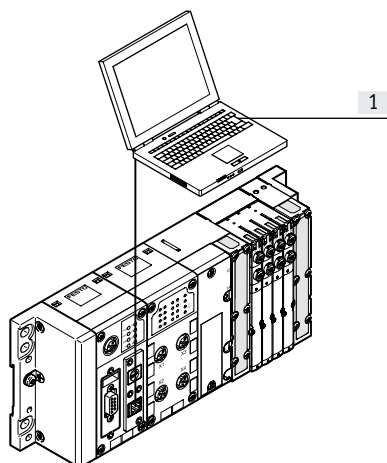

[1] CODESYS/FST

- Decentralised controller with direct machine mounting
- Downloading programs via Ethernet (or via the programming interface)
- Supports full expansion of all CPX peripherals
- More than 300 I/Os

Can be successfully used in the following applications:

- Stand-alone individual workstations
- Interlinked, stand-alone sub-systems
- Automation using IT technology

With control block in Festo EasyIP mode

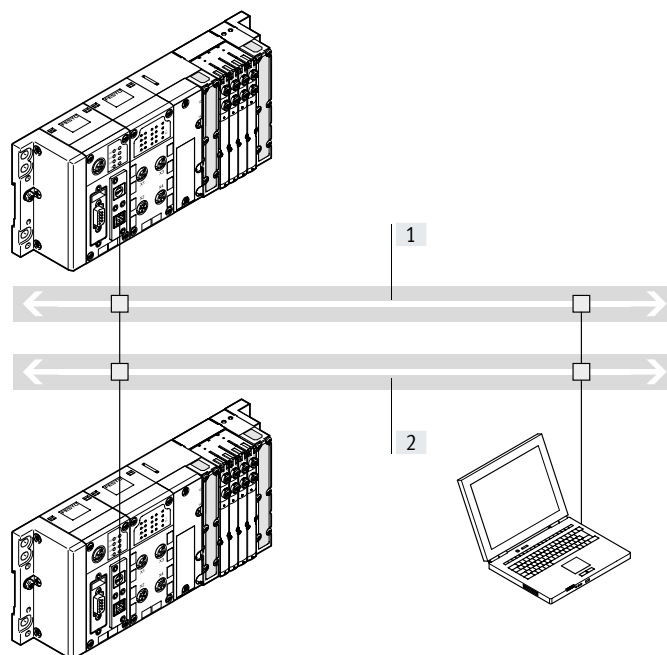

[1] Industrial Ethernet

[2] IT services:

- Web
- Email
- Data transmission

- Fast preprocessing of the CPX peripherals in the control block
- Exchange of any data between the control blocks via EasyIP
- Remote diagnostics
- No higher-order controller is required
- More than 300 I/Os per CPX control block

Key features

Variants of the CPX terminal controller (with preprocessing in the control block)

With control block as remote controller on Ethernet

Remote controller via Ethernet as the preprocessing unit for decentralised, stand-alone sub-systems using IT technology.

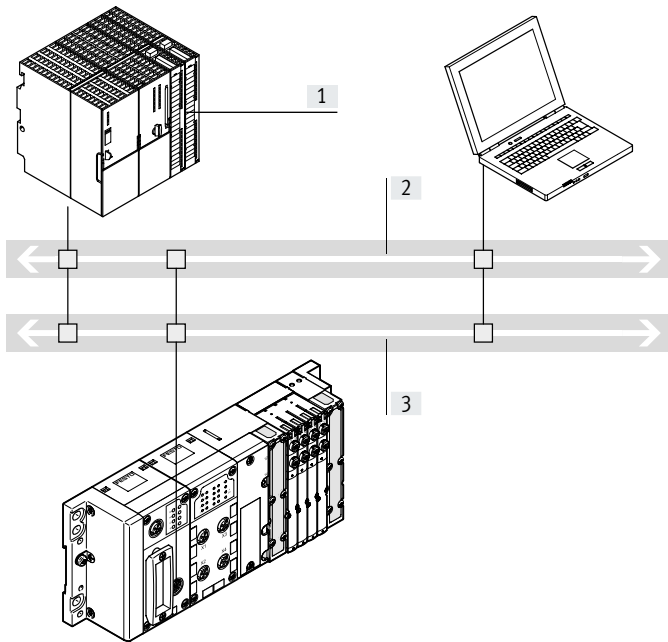

- [1] Higher-order controller (PLC)
- [2] Industrial Ethernet
- [3] IT services:
 - Web
 - Email
 - Data transmission

- Connection to a higher-order controller via Ethernet, no further bus node is required
- Monitoring via Ethernet and web applications
- Preprocessing of the CPX peripherals by CPX control block
- More than 300 I/Os

With control block as remote controller on the fieldbus

Fieldbus remote controller (combination with bus nodes for PROFIBUS DP, PROFINET, CANopen, DeviceNet, CC-Link, POWERLINK, Sercos III or EtherCAT) as the preprocessing unit for decentralised, stand-alone subsystems.

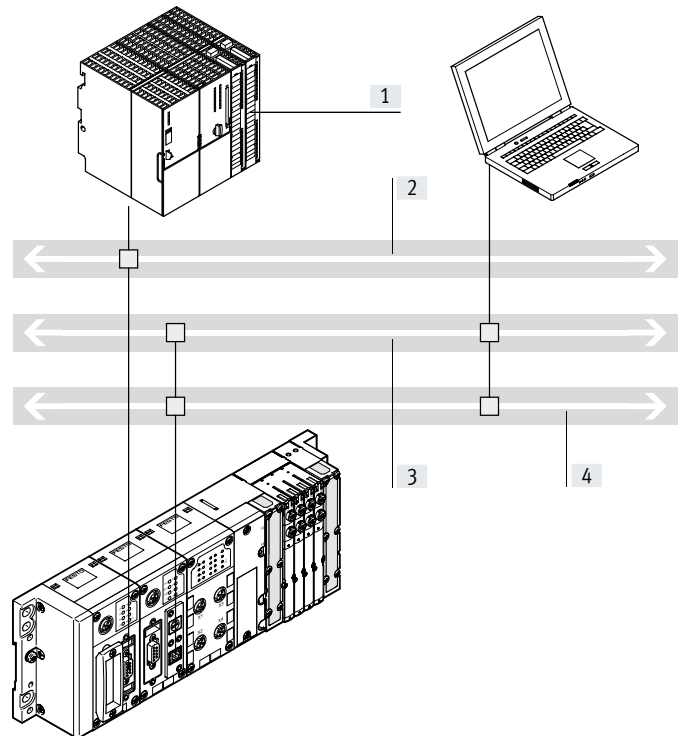

- [1] Higher-order controller (PLC)
- [2] Fieldbus
- [3] Industrial Ethernet
- [4] IT services:
 - Web
 - Email
 - Data transmission

- Fast preprocessing of the CPX peripherals in the control block
- Communication with the higher-order controller via fieldbus
- Optional additional monitoring via Ethernet and web applications
- Downloading programs via programming interface
- More than 300 I/Os, bus node is only used for communication with the higher-order PLC
- Option of two bus nodes for redundant communication configuration

Key features

Variants of the CPX terminal controller (with preprocessing in the control block)

With control block as CANopen fieldbus master

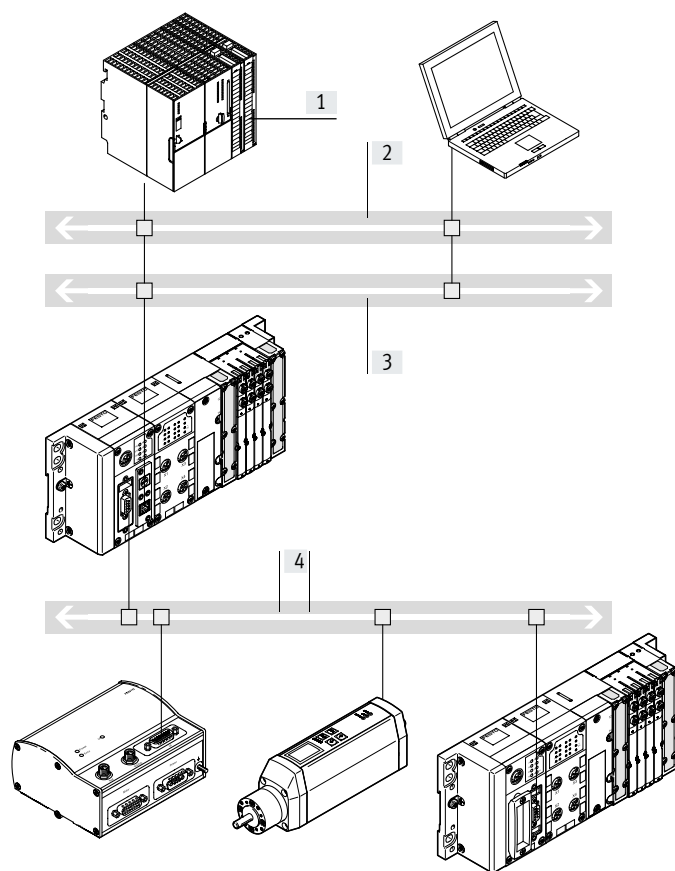

- [1] Higher-order controller (PLC)
- [2] Industrial Ethernet
- [3] IT services:
 - Web
 - Email
 - Data transmission
- [4] Fieldbus (CANopen)

Features:

- Connection to a higher-order controller via Ethernet, no further bus node is required
- Monitoring via Ethernet
- Preprocessing of the CPX peripherals by CPX control block
- More than 300 I/Os
- Up to 128 stations with repeater technology on CANopen

Operating modes:

- Remote controller on Ethernet
- Control block in Festo EasyIP mode

Key features

Connection of inputs and outputs to the CPX terminal

Digital and analogue CPX I/O modules

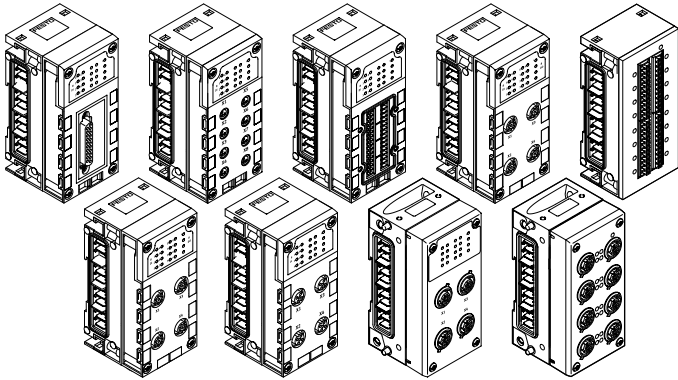

Electrical connection

The connection technology for sensors and additional actuators offers a wide range of digital and analogue input and output modules and is freely selectable – as appropriate to your standard or the application. Plastic or metal connection blocks can be combined as required:

- Metal version
 - M12-5POL
- Plastic version:
 - M12-5POL
 - M12-5-PIN with quick lock and metal thread
 - M12-8POL
 - M8-3POL
 - M8-4POL
 - Sub-D
 - CageClamp® (with cover also to IP65, IP67)
 - Screw/spring-loaded terminal

With CPX-CP interface

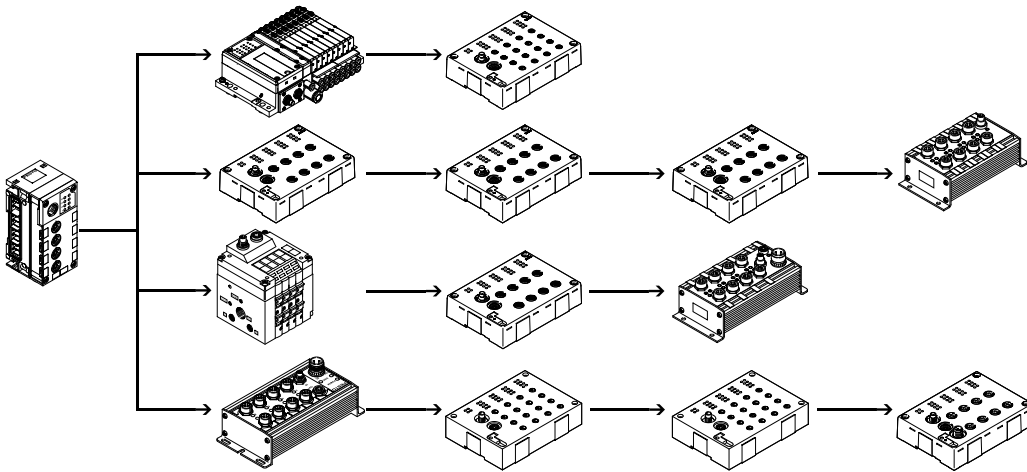

- Up to 4 strings per CP interface possible.
- Up to 4 subordinate CP modules can be combined in one string.
- Up to 32 I/Os can be connected per string.
- Modules with M8, M12
- Several CP interface modules can be combined in one CPX terminal (depending on the controller used).
- Combination of centralised CPX I/O modules and decentrally mounted I/O modules of the installation system CPI.

Combined centralised and decentralised electrical connection (valve terminal with CP interface/output module)

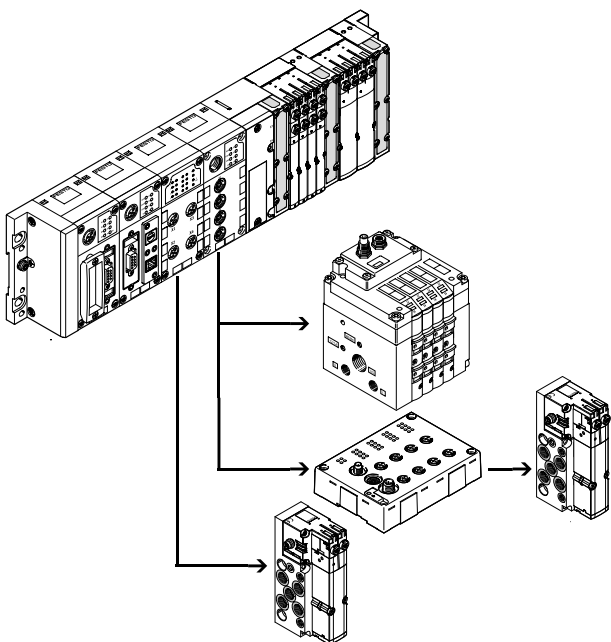

- Scalable to different requirements within a system
- One control interface in the system, reduces installation complexity with closely and widely spaced actuators
- Enables an optimum electrical and pneumatic control chain

Key features

Connection of inputs and outputs to the CPX terminal

With CPX-CTEL interface

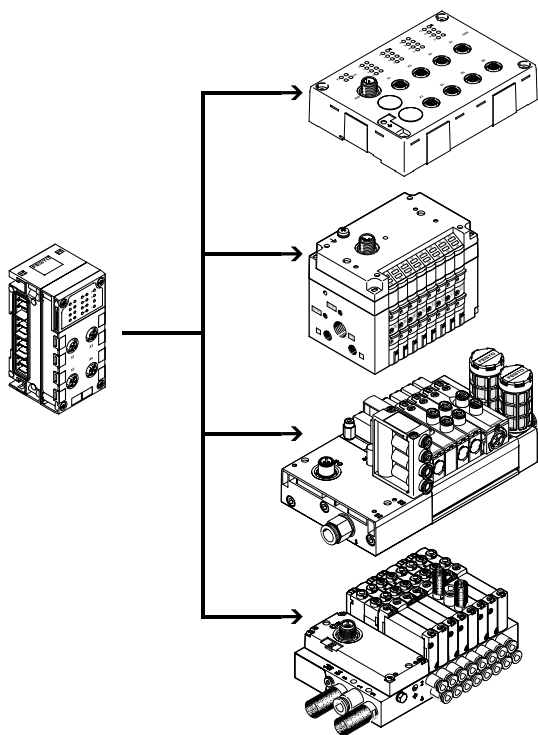

- Up to 4 devices with individual electronic protection per CPX CTEL master
- Max. 64 inputs/64 outputs per I-Port interface
- The maximum length of a string is 20 m.
- Input modules with 16 digital inputs (connection technology M8 3-pin and M12 5-pin)
- Valve terminals with I-Port interface (up to 48 solenoid coils, different valve functions)

Several CPX CTEL masters can be combined on one CPX terminal (depending on the controller used).

Combination of central CPX I/O modules and decentrally mounted I/O modules with I-Port interface.

With CPX-CTEL-2 interface

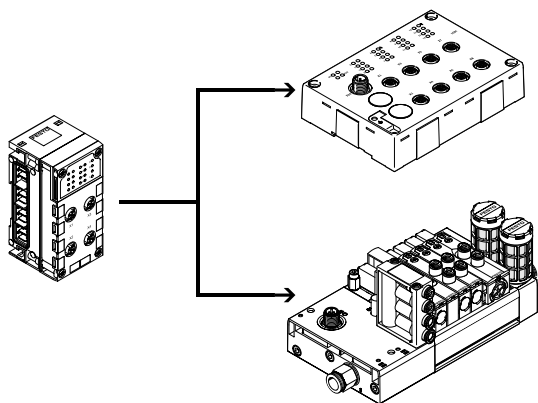

- Up to 2 IO-Link devices with individual electronic protection per CPX-CTEL-2 interface
- Max. 16-byte inputs/16-byte outputs per IO-Link device
- The maximum length of a string is 20 m.

Several CPX-CTEL-2 interfaces can be combined on one CPX terminal (depending on the controller used).

Combination of central CPX I/O modules and decentrally mounted I/O modules with IO-Link interface.

Key features

Connection of inputs and outputs to the CPX terminal

Electric drives with axis interface CPX-CM-HPP

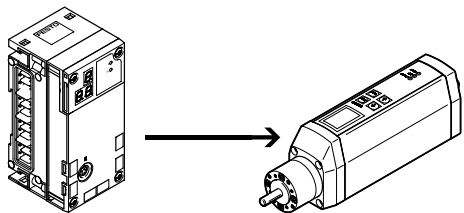

- Max. 4 individual electric axes possible per CPX-CM-HPP
- No programming required
- Standardised communication with the drives via the Festo Handling and Positioning Profile (FHPP)
- The control component is independent of the bus node used

Pneumatic drives with CPX-CMAX/CMPX

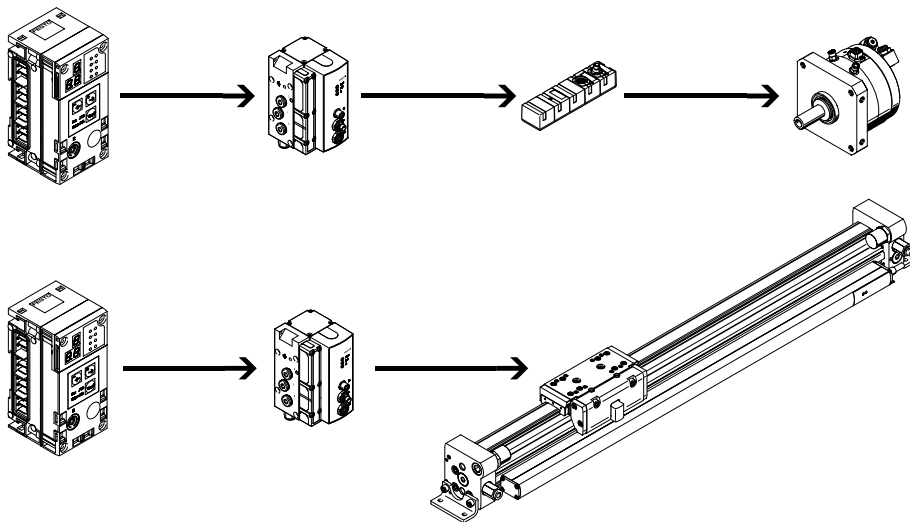

CPX-CMAX

- Position and force control, directly actuated or selected from one of 64 configurable positioning sets
- The configurable record sequencing function enables simple functional sequences to be realised
- Auto identification detects every station with its device data on the controller
- Control of a brake or clamping unit via the proportional directional control valve VPWP
- Up to 7 modules (max. 7 axes) can be operated in parallel and independently of each other
- Commissioning via the Festo configuration software FCT or via fieldbus

CPX-CMPX

- Fast travel between the mechanical end stops of the cylinder, stopping gently and without impact in the end position
- Fast commissioning via control panel, fieldbus or handheld terminal
- Improved downtime control
- Control of a brake or clamping unit via the proportional directional control valve VPWP
- Max. 9 end-position controllers can be actuated depending on the fieldbus
- All system data can be read and written via the fieldbus, including the mid-positions, for example:

Key features

Ordering

The CPX terminal with valve terminal is fully assembled according to your order specifications and individually tested. The finished valve terminal consists of the electrical peripherals including the desired actuation and the selected components of the VTSA (ISO), VTSA-F, VTSA-F-CB, MPA-S or MPA-L modules. The CPX terminal with valve terminal is ordered using two separate order codes.

One order code defines the electrical peripherals type CPX, while the other specifies the pneumatic components of the valve terminal.

The electrical peripherals type CPX can also be configured without a valve terminal and can be used on a fieldbus. To order this, only the order code for the electrical peripherals is required.

The order lists for the pneumatic components can be found at

- Internet: vtsa
(Valve terminal VTSA)
- Internet: vtsa-f
(Valve terminal VTSA-F)
- Internet: vtsa-f-cb
(Valve terminal VTSA-F-CB)
- Internet: mpa-s
(Valve terminal MPA-S)
- Internet: mpa-l
(Valve terminal MPA-L)

The order lists for the CP/CPI components can be found at

- Internet: cpi
(Installation system CPI)

The order lists for the CTEU/CTEL components can be found at

- Internet: cteu
(I-Port interface/IO-Link)

Peripherals overview

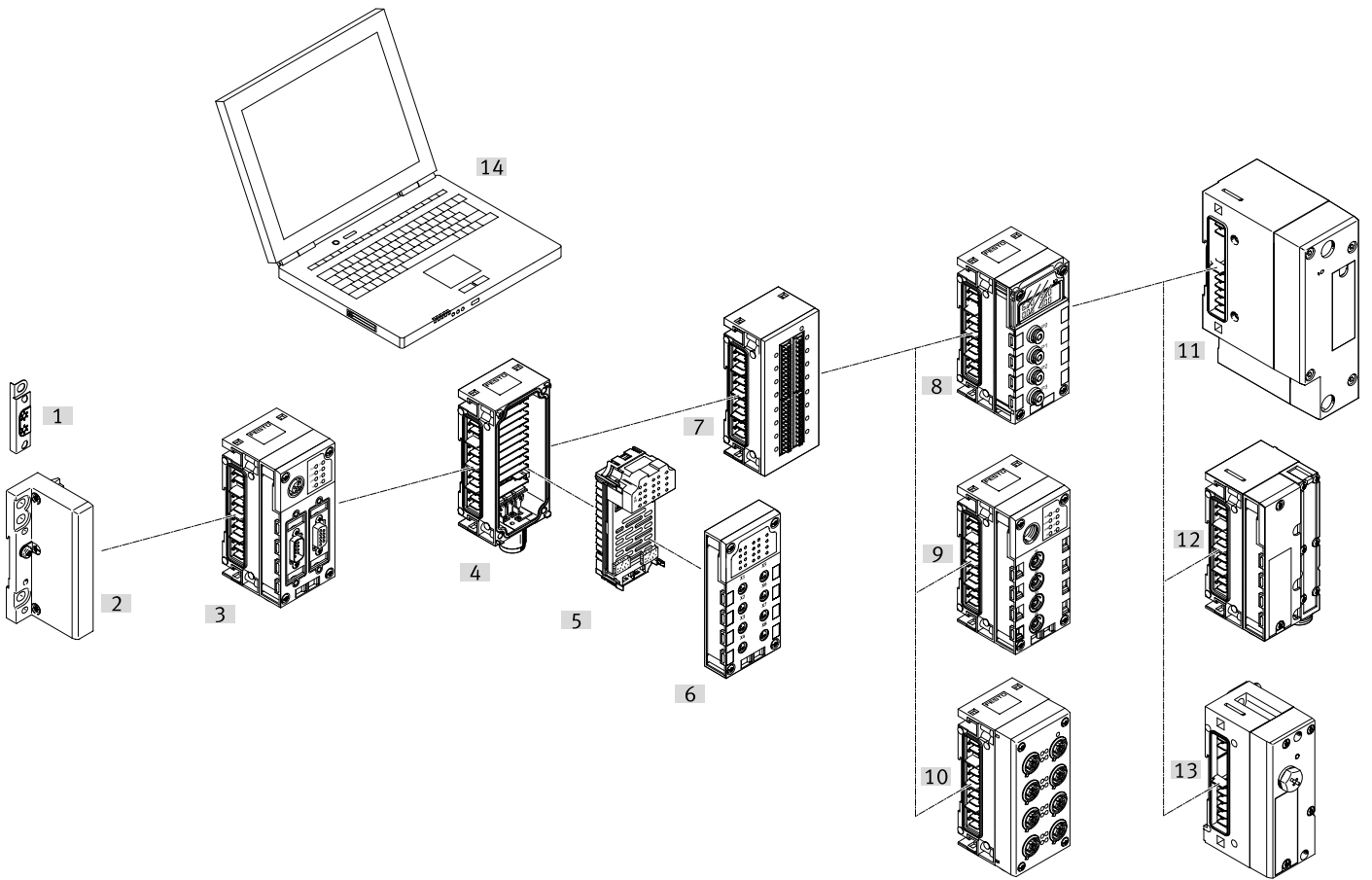

Designation	Type	Description	→ Page/Internet
[1] Earthing component	CPX-EPFE-EV	For right/left end plate	52
[2] End plate	CPX-EP	<ul style="list-style-type: none"> • Mounting holes for wall mounting • Functional earth connection • Special earthing plate for safe and easy connection to the machine bed or H-rail • External power supply for the entire system 	52
[3] Busknoten	CPX-FB CPX-M-FB	<ul style="list-style-type: none"> • Fieldbus/Industrial Ethernet connection using various types of connection technology • Setting fieldbus parameters via DIL switch • Display of fieldbus and peripheral equipment status via LED • PROFINET to AIDA standard in metal housing, fast start-up 	72
Control block	CPX-CEC	<ul style="list-style-type: none"> • Preprocessing, stand-alone controller or remote unit CPX-CEC • Connection via Ethernet TCP/IP or Sub-D programming interface • Setting operating modes via DIL switch and program selection via rotary switch • CPX-CMX products for controlling axes 	65
Gateway	CPX-IOT	<ul style="list-style-type: none"> • Separate CPX combination • Data gathering for connected components • Secure data transfer to a central storage location (MQTT broker) 	58
[4] Plastic interlinking block	CPX-GE	<ul style="list-style-type: none"> • Internal linking of the power supply and serial communication • External power supply for the entire system or for outputs or valves • Connection accessories for M18, 7/8" • Linking with tie rods 	51
Interlinking block, metal	CPX-M-GE	<ul style="list-style-type: none"> • Internal linking of the power supply and serial communication • External power supply for the entire system or for outputs • Transmission of the power supply • Connection accessories for M12x1, 7/8" or AIDA push-pull • Individual linking with M6 screws, individually expandable 	51

Peripherals overview

Designation	Type	Description	→ Page/Internet
[5] Electronics module	CPX-4DE	Input module with 4 digital inputs, positive logic (PNP)	145
	CPX-8DE	Input module with 8 digital inputs, positive logic (PNP)	
	CPX-8DE-D	Input module with 8 digital inputs, positive logic (PNP), enhanced diagnostic function	
	CPX-8NDE	Input module with 8 digital inputs, negative logic (NPN)	
	CPX-P-8DE-N	NAMUR input module with 8 digital inputs	150
	CPX-F8DE-P	PROFIsafe input module with 8 digital inputs	154
	CPX-16DE	Input module with 16 digital inputs, internal electronic fuse per module	160
	CPX-M-16DE-D	Input module with 16 digital inputs, internal electronic fuse per channel pair, for CPX in metal	
	CPX-4DA	Output module with 4 digital outputs, 1 A per channel	166
	CPX-8DA	Output module with 8 digital outputs, 0.5 A per channel	
	CPX-8DA-H	Output module with 8 digital outputs, 2.1 A per channel pair	
	CPX-8DE-8DA	Input/output module with 8 digital inputs and 8 digital outputs	172
	CPX-2ZE2DA	Counter module with 2 digital inputs and 2 digital outputs	177
	CPX-4AE-4AA-H	HART input/output module with 4 analogue input/outputs	181
	CPX-2AE-U-I	Input module with 2 analogue current and/or voltage inputs	186
	CPX-4AE-U-I	Input module with 4 analogue current and/or voltage inputs	
	CPX-4AE-I	Input module with 4 analogue current inputs	
	CPX-4AE-T	Input module for temperature inputs	193
	CPX-4AE-TC	Input module for temperature inputs with cold junction compensation	197
	CPX-2AA-U-I	Output module with 2 analogue current or voltage outputs	201
CPX-FVDA-P2	PROFIsafe shut-off module for shutting off the supply voltage for valves, with two digital outputs	205	
[6] Plastic connection block	CPX-AB	<ul style="list-style-type: none"> Choice of 8 connection technology variants Degree of protection IP65, IP67 or IP20 Can be combined with the electronics modules Connection accessories for M8/M12/Sub-D M8/M12/Sub-D, etc. connecting cables Modular system for M8/M12 connecting cables 	–
[7] Connection block including electronics module and interlinking block	CPX-L	<ul style="list-style-type: none"> Spring-loaded terminal Degree of protection IP20 Digital input module with 16 inputs Digital I/O module with 8 inputs and 8 outputs Plastic connection block 	–
[8] Analogue electronics module for pressure inputs	CPX-4AE-P	<ul style="list-style-type: none"> Pneumatic connection QS-4 Degree of protection IP 65, IP67 4 analogue pressure inputs (0 ... 10 bar, –1 ... +1 bar) 	191
[9] CP interface CTEL interface	CPX-CP	<ul style="list-style-type: none"> Interfaces for decentralised installation systems, thus optimising the pneumatic control chains (short tubes/short cycle times) Actuation for I/O modules and valve terminals Power supply and bus interface via the same cable M9, M12 connection technology Degree of protection IP 65, IP67 	117
	CPX-CTEL		122
[10] Metal connection block	CPX-M-AB	<ul style="list-style-type: none"> Can be combined with the electronics modules Connection technology M12x1, 5-pin Degree of protection IP 65, IP67 Connection accessories for M12 Connecting cable M12, Modular system for choice of connecting cables M12 	–
[11] Pneumatic interface VTSA	VABA-S6	<ul style="list-style-type: none"> Control of valve terminal VTSA/VTSA-F/VTSA-F-CB Control of pressure sensors 	236
[12] Pneumatic interface MPA-S	VMPA-FB	<ul style="list-style-type: none"> Control of valve terminal MPA-S Control of pressure sensors Control of proportional pressure regulators 	231
[13] Pneumatic interface MPA-L	VMPAL-EPL-CPX	Control of valve terminal MPA-L	234
[14] Web monitor	–	<ul style="list-style-type: none"> Website integrated in the CPX terminal Dynamic status indication Online diagnostics and SMS/e-mail alert 	–

Peripherals overview

Individual overview of modules

Bus node

→ Page 72

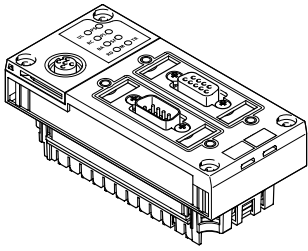

Bus node for

- PROFIBUS DP
 - DeviceNet
 - CANopen
 - CC-Link
 - EtherNet/IP
- PROFINET
 - POWERLINK
 - EtherCAT
 - Sercos III

Control block

→ Page 65

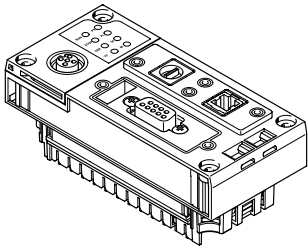

CPX-CEC

- Programming with CODESYS
- Ethernet interface
- Modbus/TCP
- EasyIP
- CANopen master

Gateway

→ Page 58

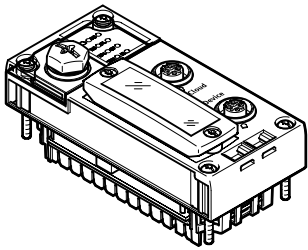

CPX-IOT

- Continuous transfer of operating data from connected Festo components to a central storage location (user-specific MQTT broker)
- Ethernet interface

CP interface

→ Page 117

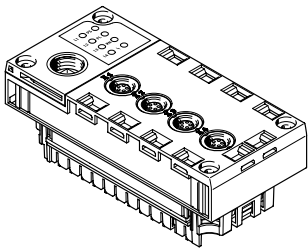

Interface CPX-CP

- 4 CP strings
- Max. 4 modules per string
- 32 inputs/32 outputs per string
- CPI functionality

CTEL interface

→ Page 122

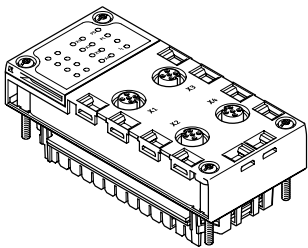

CPX-CTEL interface

- CTEL master
- Max. 4 devices with individual electronic protection
- Max. 64 inputs/64 outputs per I-Port interface
- The maximum length of a string is 20 m

Electrical interface CPX-CTEL-2

→ Page 128

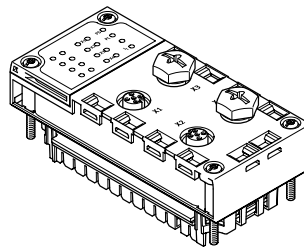

CPX-CTEL-2 interface

- Master for IO-Link
- Max. 2 devices with individual electronic protection
- Process data length of the inputs and outputs is limited to 16 bytes for inputs and 16 bytes for outputs per port
- The maximum length of a string is 20 m

Peripherals overview

Individual overview of modules

Modules for actuating electric drive units

→ Page 133

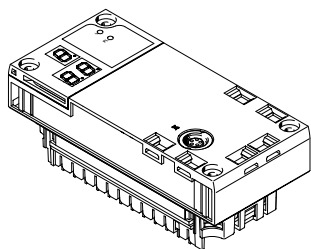

CPX-CM-HPP

- Axis interface
- CAN bus for up to 4 individual electric axes

Modules for controlling pneumatic drive units

→ Page 136

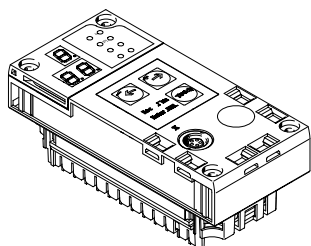

CPX-CMAX

- Axis controller
- Position and force control
- 64 configurable positioning records
- Auto-identification
- Control of a brake or clamping unit via the proportional directional control valve VPWP

CPX-CMPX

- End-position controller
- Fast travel between the mechanical end stops of the cylinder
- Smooth travel into the end position
- Improved downtime control
- Control of a brake via the proportional directional control valve VPWP

CPX-CMIX

- Measuring module
- CAN input (Festo specification) for measuring signal
- Recording the absolute position values or speed values of the connected drive

Plastic connection block

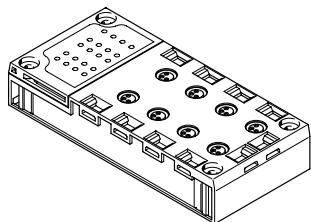

Direct machine mounting (degree of protection IP65, IP67)

- M8-3POL
- M8-4POL
- M12-5POL
- M12-5POL quick lock, shielded with metal thread
- M12-8POL
- Sub-D
- Spring-loaded terminal with cover

Protected fitting space (degree of protection IP20)

- Spring-loaded terminal

Shielding concept

- Optional screening plate for connection blocks with M12 connection technology

Metal connection block

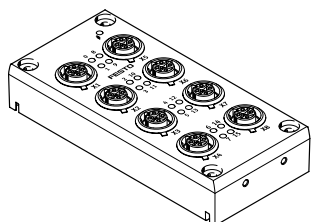

Direct machine mounting (degree of protection IP65, IP67)

- M12-5POL

Connection block including electronics module and interlinking block

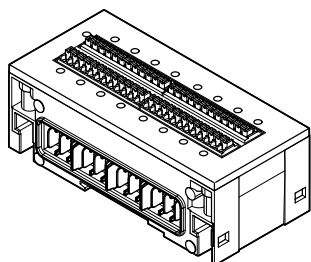

Installation in the control cabinet (degree of protection IP20)

- Plastic connection block
- Spring-loaded terminal
- Digital input module with 16 inputs
- Digital I/O module with 8 inputs and 8 outputs

Peripherals overview

Individual overview of modules

Connection block for NAMUR sensors and HART input/output module

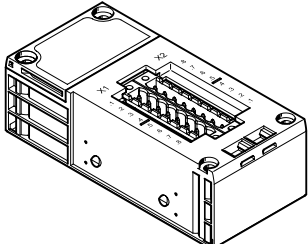

- Direct machine mounting
(connection block to IP65)
- M12-4POL

- Protected fitting space
(connection block to IP20)
- Screw terminal
 - Spring-loaded terminal

Digital electronics module for inputs/outputs

→ Page 145

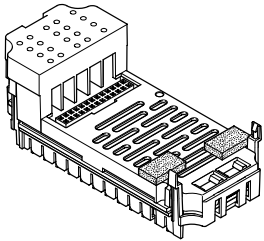

- Digital inputs
- 4 digital inputs
 - 8 digital inputs NPN
 - 8 digital inputs PNP
 - 8 digital inputs PNP with individual channel diagnostics
 - 16 digital inputs
 - 16 digital inputs with individual channel diagnostics

- Digital outputs
- 4 digital outputs (1 A per channel, individual channel diagnostics)
 - 8 digital outputs (0.5 A per channel, individual channel diagnostics)
 - 8 digital outputs (2.1 A/50 W lamp load per channel pair, individual channel diagnostics)

- Multi I/O modules
- 8 digital inputs and 8 digital outputs
 - 2 digital inputs (counter channels, connection to various encoders) and 2 digital outputs (directly controlled by the input values)

Digital electronics module for NAMUR sensors

→ Page 150

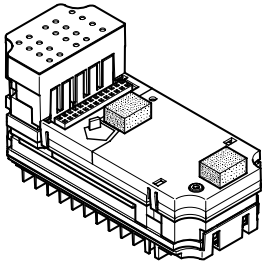

- Digital inputs
- 8 digital inputs for NAMUR sensors or wired mechanical contacts

Analogue electronics module for inputs/outputs

→ Page 186

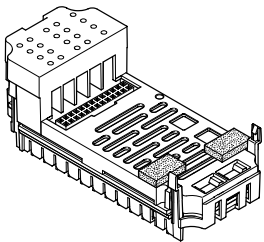

- Analogue inputs
- 2 analogue inputs (0 ... 10 V DC, 0 ... 20 mA, 4 ... 20 mA)
 - 4 analogue inputs (1 ... 5 V, 0 ... 10 V, -5 ... +5 V, -10 ... +10 V, 0 ... 20 mA, 4 ... 20 mA, -20 ... +20 mA)
 - 4 analogue inputs with HART protocol

- Analogue temperature inputs
- 4 analogue inputs for temperature measurement (Pt100, Pt200, Pt500, Pt1000, Ni100, Ni120, Ni500, Ni1000)
 - 4 analogue inputs for temperature measurement (thermocouple and PT1000 sensor for cold-junction compensation)

- Analogue outputs
- 2 analogue outputs (0 ... 10 V DC, 0 ... 20 mA, 4 ... 20 mA)
 - 4 analogue outputs with HART protocol

PROFIsafe input module

→ Page 154

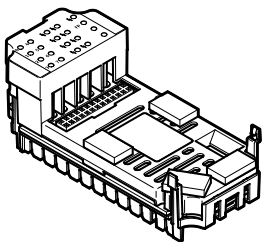

- Digital inputs
- 8 digital inputs
 - 11 function modes
 - 5 independent clock outputs

PROFIsafe shut-off module

→ Page 205

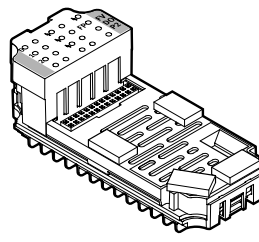

- Digital outputs
- 2 digital outputs
 - Supply voltage for valves can be shut off

Peripherals overview

Individual overview of modules

Analogue electronics module for pressure inputs

→ Page 191

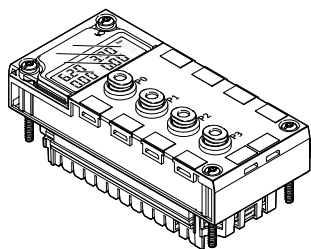

Analogue inputs

- 4 analogue pressure inputs (0 ... 10 bar, -1 ... +1 bar)

Plastic interlinking block – Interlinking using tie rods

→ Page 214

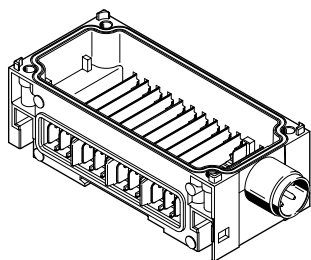

System linking

- Different voltages for supplying the modules
- Serial communication between the modules

System supply

- M18, 4-pin
- 7/8" 4-pin or 5-pin

In addition to system linking, power supply for the

- Electronics plus sensors (16 A)
- Valves plus actuators (16 A)

Additional supply

In addition to system linking, power supply for the

- Actuators (16 A per supply)

Power supply for the

- Valves (16 A per supply)

Expandability

- Can be expanded using an interlinking block with tie rod CPX-ZA-1-E

Metal interlinking block – Individual linking

→ Page 215

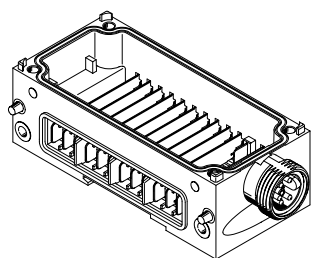

System linking

- Different voltages for supplying the modules
- Serial communication between the modules

System supply

- 7/8" 4-pin or 5-pin
- M12x1, L-coded, 5-pin
- AIDA push-pull

In addition to system linking, power supply for the

- Electronics plus sensors (16 A)
- Valves plus actuators (16 A)

Additional supply

In addition to system linking, power supply for the

- Actuators (16 A per supply)

Power supply for the

- Valves (16 A per supply)

System forwarding

In addition to system linking, transmission of power supply from the

- Electronics plus sensors (16 A)
- Valves plus actuators (16 A)

to a further CPX terminal or another consuming device.

Expandability

- Can be expanded as required by up to 10 interlinking blocks

- - Note

Plastic interlinking blocks (tie rods) and metal interlinking blocks (individual linked) cannot be combined due to their different interlinking systems.

- - Note

The 7/8" supply is subject to the following restrictions due to the available accessories:

- 5-pin 8 A
- 4-pin 10 A

- - Note

Appropriate interlinking blocks (CPX-...-VL) must be used in ATEX environments as per the certification (→ page 49). The maximum supply is limited to 8 A for these modules.

Peripherals overview

Individual overview of modules

Pneumatic interface MPA-S

→ Page 231

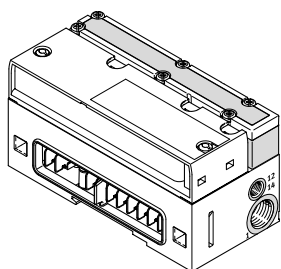

- Valve terminal
- MPA1 (360 l/min)
 - MPA14 (550 l/min)
 - MPA2 (700 l/min)
 - Up to 128 solenoid coils
 - Up to 16 modules can be configured
 - For CPX plastic design
 - For CPX metal design
 - Actuation of pressure sensors
 - Proportional pressure regulators
 - Pressure sensors
 - Proportional pressure regulators

Pneumatic interface MPA-L

→ Page 234

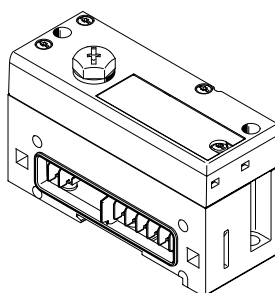

- Valve terminal
- MPA1 (360 l/min)
 - MPA14 (670 l/min)
 - MPA2 (870 l/min)
 - Up to 32 solenoid coils
 - For CPX plastic design

Pneumatic interface VTSA/VTSA-F

→ Page 236

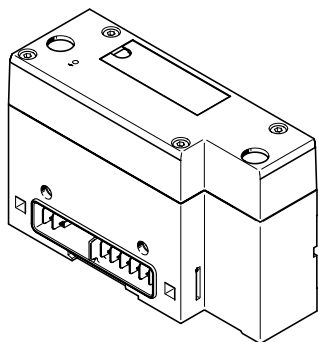

- Valve terminal (valve flow rate according to width)
- 18 mm (700 l/min)
 - 26 mm (1350 l/min)
 - 42 mm (1300 l/min)
 - 52 mm (2900 l/min)
 - 65 mm (4000 l/min)
 - Max. 32 valve positions/max. 32 solenoid coils
 - For CPX plastic design
 - For CPX metal design

Pneumatic interface VTSA-F-CB

→ Page 238

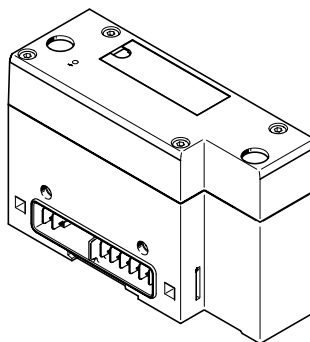

- Valve terminal (valve flow rate according to width)
- 18 mm (700 l/min)
 - 26 mm (1350 l/min)
 - 42 mm (1300 l/min)
 - 52 mm (2900 l/min)
 - Max. 24 valve positions/max. 24 solenoid coils
 - For CPX plastic design
 - For CPX metal design

Pneumatic interface VTSA-F-CB

→ Page 238

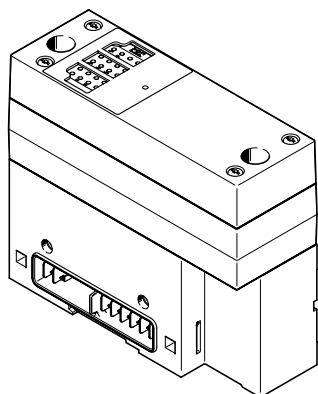

- Valve terminal (valve flow rate according to width)
- 18 mm (700 l/min)
 - 26 mm (1350 l/min)
 - 42 mm (1300 l/min)
 - 52 mm (2900 l/min)
 - Max. 24 valve positions/max. 24 solenoid coils
 - For CPX metal design
 - With 3 voltage zones within the valve terminal that can be securely shut down via fieldbus
 - With 2 voltage zones within the valve terminal that can be securely shut down via fieldbus and one power supply for external consuming devices that can be securely shut down via fieldbus

Pneumatic interface VTSA-F-CB

→ Page 238

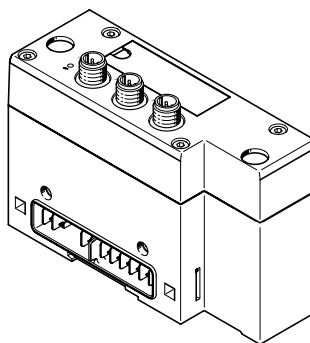

- Valve terminal (valve flow rate according to width)
- 18 mm (700 l/min)
 - 26 mm (1350 l/min)
 - 42 mm (1300 l/min)
 - 52 mm (2900 l/min)
 - Max. 24 valve positions/max. 24 solenoid coils
 - For CPX plastic design
 - For CPX metal design
 - 3 external voltage supplies for voltage zones within the valve terminal that can be shut down individually

Peripherals overview

Individual overview of modules

End plate for plastic/metal design

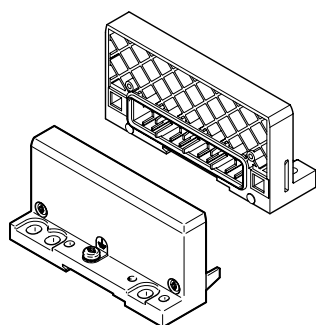

End plate

- Left-hand
- Right-hand (for using the CPX terminal without valves)

End plate with system supply

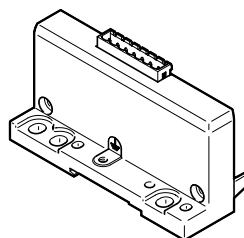

End plate

- Left-hand
- For plastic design
- Different voltages for supplying the CPX terminal

→ Page 210

End plate with extension

→ Page 212

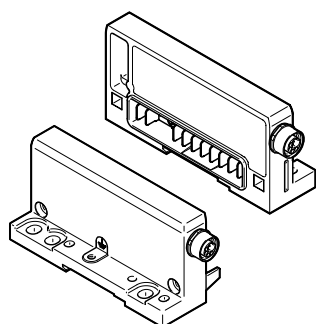

End plate

- Left-hand
- Right-hand
- Enables the CPX terminal to be separated into two interconnected units (series)
- Simplifies control cabinet installation
- For plastic or metal design

Earthing plate (for end plate for plastic design)

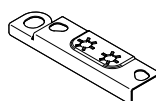

Earthing plate

- For safe and easy connection to the machine bed or H-rail, suitable for right-hand and left-hand end plate
- Assembly and earthing in a single processing step, which means:
 - 50% time saving
 - No additional material required

General basic data and guidelines

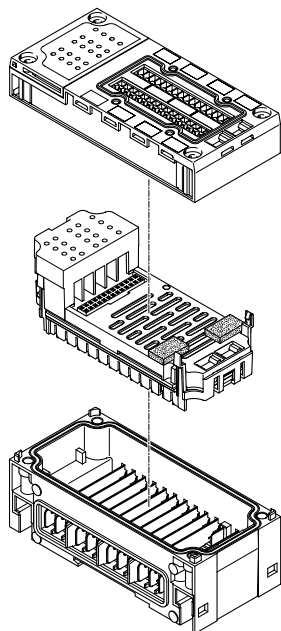

Max. 11 modules in total:

- One bus node and/or one control block, freely positionable
- Up to 9 additional input/output modules, freely positionable
- An additional pneumatic interface always positioned as the last module on the right-hand side
 - For VTSA, VTSA-F: Fixed operating range, set using DIL switch
 - For VTSA-F-CB: Fixed operating range
 - For MPA-S: 16 MPA modules can be configured
 - For MPA-L: Fixed operating range, set using rotary switch
- Address capacity max. 512 inputs and 512 outputs, depending on bus node or control block
- One interlinking block with system supply
- Multiple interlinking blocks with additional supplies
 - Always positioned to the right of the interlinking block with system supply
- With just a few exceptions, the connection blocks can be freely combined with the electronics modules for inputs/outputs, either in metal or plastic design (→ table below)
- The electronics modules for inputs/outputs can be combined with various interlinking blocks

- Plastic interlinking blocks (tie rods) and metal interlinking blocks (individual linked) cannot be combined due to their different interlinking systems.

Peripherals overview

Combinations of connection blocks and digital input modules						
	Digital electronics modules					
	CPX-4DE	CPX-8DE	CPX-8DE-D	CPX-8NDE	CPX-P-8DE-N	CPX-F8DE-P
Connection blocks, plastic design						
CPX-AB-8-M8-3POL	■	■	■	■	-	-
CPX-AB-8-M8X2-4POL	-	-	-	-	-	-
CPX-P-AB-4XM12-4POL	-	-	-	-	■	-
CPX-AB-4-M12x2-5POL	■	■	■	■	-	-
CPX-AB-4-M12x2-5POL-R	■	■	■	■	-	-
CPX-AB-8-M12X2-5POL	-	-	-	-	-	-
CPX-AB-4-M12-8POL	-	-	-	-	-	-
CPX-AB-8-KL-4POL	■	■	■	■	-	■
CPX-P-AB-2XKL-8POL	-	-	-	-	■	-
CPX-AB-1-SUB-BU-25POL	■	■	■	■	-	-
CPX-AB-ID-P	-	-	-	-	-	■
Connection blocks, metal design						
CPX-M-AB-4-M12X2-5POL	■	■	■	■	-	■
CPX-M-AB-4-M12X2-5POL-T	-	-	-	-	-	■
CPX-M-AB-8-M12X2-5POL	-	-	-	-	-	-

Combinations of connection blocks and digital input modules			
	Digital electronics modules		
	CPX-16DE	CPX-L-16DE	CPX-M-16DE-D
Connection blocks, plastic design			
CPX-AB-8-M8-3POL	-	-	-
CPX-AB-8-M8X2-4POL	■	-	-
CPX-P-AB-4XM12-4POL	-	-	-
CPX-AB-4-M12x2-5POL	-	-	-
CPX-AB-4-M12x2-5POL-R	-	-	-
CPX-AB-8-M12X2-5POL	-	-	■
CPX-AB-4-M12-8POL	-	-	-
CPX-AB-8-KL-4POL	■	-	-
CPX-P-AB-2XKL-8POL	-	-	-
CPX-AB-1-SUB-BU-25POL	■	-	-
CPX-AB-ID-P	-	-	-
Connection blocks, metal design			
CPX-M-AB-4-M12X2-5POL	-	-	-
CPX-M-AB-4-M12X2-5POL-T	-	-	-
CPX-M-AB-8-M12X2-5POL	-	-	■

Peripherals overview

Combinations of connection blocks and digital output modules or multi I/O modules								
	Digital electronics modules							
	CPX-4DA	CPX-8DA	CPX-8DA-H	CPX-8DE-8DA	CPX-L-8DE-8DA	CPX-2ZE2DA	CPX-FVDA-P2	
Connection blocks, plastic design								
CPX-AB-8-M8-3POL	■	■	-	-	-	-	-	
CPX-AB-8-M8X2-4POL	■	■	■	-	-	-	-	
CPX-P-AB-4XM12-4POL	-	-	-	-	-	-	-	
CPX-AB-4-M12x2-5POL	■	■	-	-	-	-	-	
CPX-AB-4-M12x2-5POL-R	■	■	■	-	-	-	-	
CPX-AB-8-M12X2-5POL	-	-	-	-	-	-	-	
CPX-AB-4-M12-8POL	-	-	-	■	-	-	-	
CPX-AB-8-KL-4POL	■	■	■	■	-	-	■	
CPX-P-AB-2XKL-8POL	-	-	-	-	-	-	-	
CPX-AB-1-SUB-BU-25POL	■	■	■	■	-	-	-	
CPX-AB-ID-P	-	-	-	-	-	-	-	
Connection blocks, metal design								
CPX-M-AB-4-M12X2-5POL	■	■	■	-	-	-	■	
CPX-M-AB-4-M12X2-5POL-T	-	-	-	-	-	-	-	
CPX-M-AB-8-M12X2-5POL	-	-	-	-	-	-	-	
Combinations of connection blocks and analogue electronics modules for inputs/outputs								
	Analogue electronics modules							
	CPX-4AE-4AA-H	CPX-2AE-U-I	CPX-4AE-U-I	CPX-4AE-I	CPX-2AA-U-I	CPX-4AE-P	CPX-4AE-T	CPX-4AE-TC
Connection blocks, plastic design								
CPX-AB-8-M8-3POL	-	-	-	-	-	-	-	-
CPX-AB-8-M8X2-4POL	-	-	-	-	-	-	-	-
CPX-P-AB-4XM12-4POL	■	-	-	-	-	-	-	-
CPX-AB-4-M12x2-5POL	-	■	■	■	■	-	■	■
CPX-AB-4-M12x2-5POL-R	-	■	■	■	■	-	■	■
CPX-AB-8-M12X2-5POL	-	-	-	-	-	-	-	-
CPX-AB-4-M12-8POL	-	-	-	-	-	-	-	-
CPX-AB-8-KL-4POL	-	■	■	■	■	-	■	■
CPX-P-AB-2XKL-8POL	■	-	-	-	-	-	-	-
CPX-AB-1-SUB-BU-25POL	-	■	■	■	■	-	-	-
CPX-AB-ID-P	-	-	-	-	-	-	-	-
Connection blocks, metal design								
CPX-M-AB-4-M12X2-5POL	-	■	■	■	■	-	■	■
CPX-M-AB-4-M12X2-5POL-T	-	-	-	-	-	-	-	-
CPX-M-AB-8-M12X2-5POL	-	-	-	-	-	-	-	-

Key features – Electrical components

Electrical connection – Connection block

CPX-AB-8-M8-3POL with connection socket M8, 3-pin

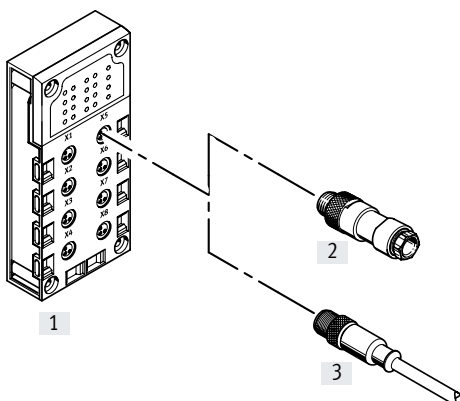

- Compact for pre-assembled individual connection
- 8 sockets
- 3-pin design for connecting one channel per socket

Note
Festo delivers pre-assembled M8/M12 connecting cables (NEBU modular system) on request:

- Tailored to the application
- Perfectly fitting
- Easy to install

Combination of connection block and electrical connection technology

Connection block	Connection technology	Plug/connecting cable	Connection technology
[1] CPX-AB-8-M8-3POL	Socket M8, 3-pin	[2] SEA-GS-M8	Solder lugs
		[2] SEA-3GS-M8-S	Screw terminals
		[3] NEBU-...-M8G3 (modular system for choice of connecting cables)	Socket, M8, 3-pin
			Socket, M8, 4-pin
			Socket, M12, 5-pin
		Open cable end	

Key features – Electrical components

Electrical connection – Connection block

CPX-AB-8-M8X2-4POL with connection socket M8, 4-pin

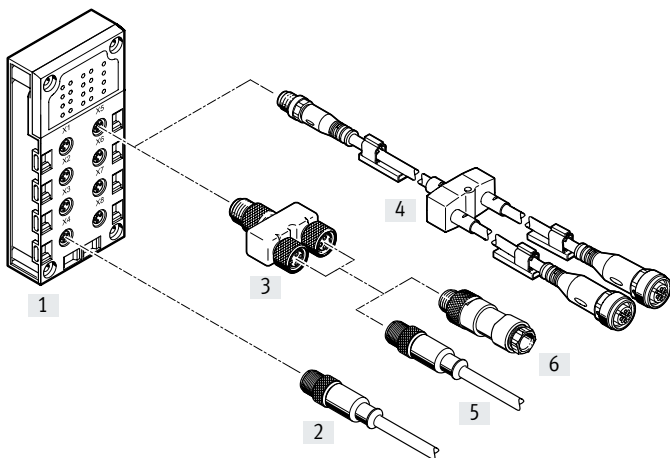

- Compact for pre-assembled individual connection
- 8 sockets
- 4-pin design for connection of 2 channels per socket

Combination of connection block and electrical connection technology					
Connection block	Connection technology	Plug/connecting cable	Connection technology	Plug/connecting cable	Connection technology
[1] CPX-AB-8-M8X2-4POL	Socket, M8, 4-pin	[2] NEBU-...-M8G4 (modular system for choice of connecting cables)	Socket, M8, 3-pin	-	-
			Socket M8, 4-pin	-	-
			Socket, M12, 5-pin	-	-
			Open cable end	-	-
		[3] NEDY-L2R1-V1-M8G3-N-M8G4 (T-adapter)	1x plug M8, 4-pin to 2x socket, M8, 3-pin	[6] SEA-GS-M8	Solder lugs
				[6] SEA-3GS-M8-S	Screw terminals
				[5] NEBU-...-M8G3 (modular system for choice of connecting cables)	Socket, M8, 3-pin Socket, M8, 4-pin Socket, M12, 5-pin Open cable end
		[4]NEDY-... (modular system for all types of sensor/ actuator distributor)	2x socket, M8, 3-pin	-	-
			2x socket, M8, 4-pin	-	-
			2x socket, M12, 5-pin	-	-
			2x socket, type A	-	-
			2x socket, type B	-	-
			2x socket, type C	-	-
			2x socket, plug pattern H	-	-
			2x socket, plug pattern ZB	-	-
		2x socket, plug pattern ZC	-	-	
2x open cable end	-	-			

Key features – Electrical components

Electrical connection – Connection block

CPX-AB-4-M12x2-5POL and CPX-AB-4-M12x2-5PPOL-R with connection socket M12, 5-pin

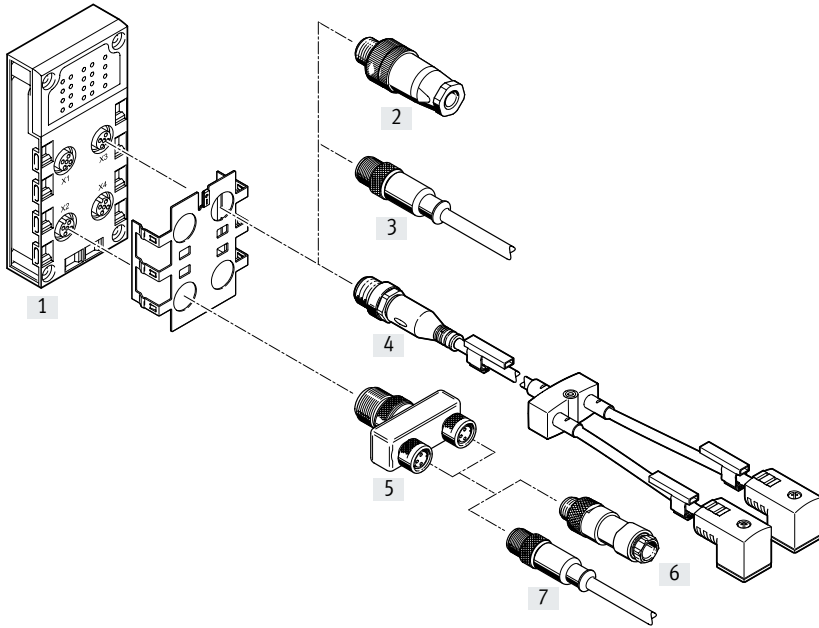

- Suitable for self-assembly and sturdy with 2 channels per connection
- 4 sockets
- 5-pin design per connection
- Version ...-R with quick lock technology and metal thread for shielding
- With two channels per connection, the corresponding input signals can be easily connected via a T-adaptor and conventional cables with M8 connection.

Key features – Electrical components

Combination of connection block and electrical connection technology					
Connection block	Connection technology	Plug/connecting cable	Connection technology	Plug/connecting cable	Connection technology
[1] CPX-AB-4-M12x2-5POL CPX-AB-4-M12x2-5POL-R	Socket, M12, 5-pin	[2] SEA-GS-7	Screw terminals	–	–
		[2] SEA-4GS-7-2.5	Screw terminals	–	–
		[2] SEA-GS-9	Screw terminals	–	–
		[2] SEA-M12-5GS-PG7	Screw terminals	–	–
		[2] SEA-GS-11-DUO	Screw terminals, for two cables	–	–
		[2] SEA-5GS-11-DUO	Screw terminals, for two cables	–	–
		[3] NEBU-...-M12G5 (modular system for choice of connecting cables)	Socket, M8, 4-pin Socket, M12, 5-pin Open cable end	– – –	– – –
		[4] NEDY-... (modular system for all types of sensor/ actuator distributor)	2x socket, M8, 3-pin 2x socket, M8, 4-pin 2x socket, M12, 5-pin 2x socket, type A 2x socket, type B 2x socket, type C 2x socket, plug pattern H 2x socket, plug pattern ZB 2x socket, plug pattern ZC 2x open cable end	– – – – – – – – – –	– – – – – – – – – –
		[5] NEDY-L2R1-V1-M8G3-N-M12G4 (T-adapter)	Plug M12, 4-pin to 2x socket, M8, 3-pin	–	–
		[5] NEDY-L2R1-V1-M12G5-N-M12G4 (T-adapter)	Plug M12, 4-pin to 2x socket M12, 5-pin	–	–
				[6] SEA-GS-M8	Solder lugs
				[6] SEA-3GS-M8-S	Screw terminals
				[7] NEBU-...-M8G3 (modular system for choice of connecting cables)	Socket, M8, 3-pin Socket, M8, 4-pin Socket, M12, 5-pin Open cable end
				[6] SEA-GS-7	Screw terminals
				[6] SEA-4GS-7-2.5	Screw terminals
				[6] SEA-GS-9	Screw terminals
				[6] SEA-M12-5GS-PG7	Screw terminals
				[6] SEA-GS-11-DUO	Screw terminals, for two cables
				[6] SEA-5GS-11-DUO	Screw terminals, for two cables
				[7] NEBU-...-M12G5 (modular system for choice of connecting cables)	Socket, M8, 4-pin Socket, M12, 5-pin Open cable end

Key features – Electrical components

Electrical connection – Connection block (metal design)

CPX-M-AB-4-M12X2-5POL and CPX-M-AB-4-M12X2-5POL-T with connection socket M12, 5-pin

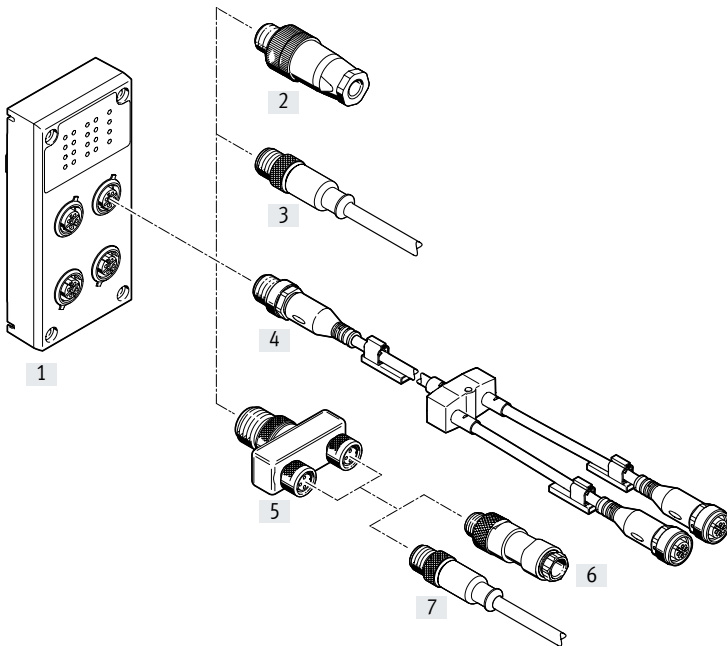

- Suitable for self-assembly and sturdy with 2 channels per connection
- 4 sockets
- 5-pin design per connection
- With two channels per connection, the corresponding input signals can be easily connected via a T-adapter and conventional cables with M8 connection.

CPX-M-AB-8-M12X2-5POL and CPX-AB-8-M12X2-5POL with connection socket M12, 5-pin

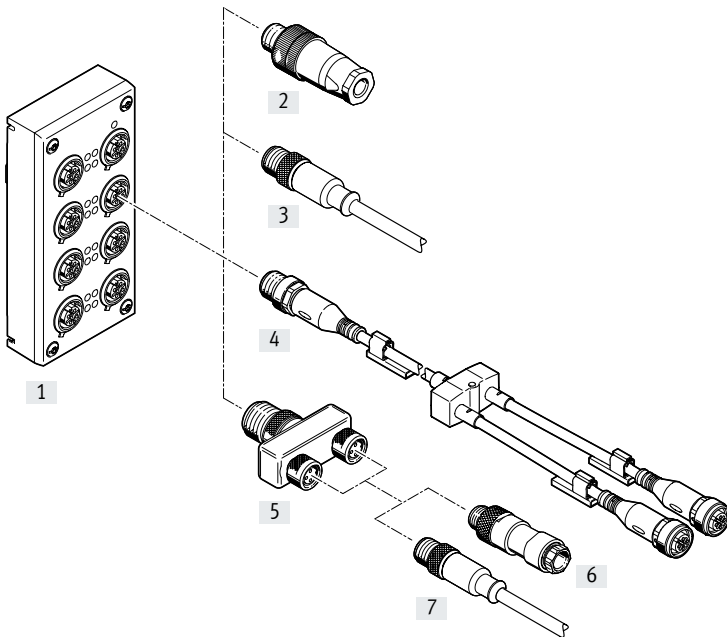

- Suitable for self-assembly and sturdy with 2 channels per connection
- 8 sockets
- 5-pin design per socket
- With two channels per connection, the corresponding input signals can be easily connected via a T-adapter and conventional connecting cables with M8 connection.

Note

Max. 4 T-adapters (NEDY) can be mounted on a connection block.

Key features – Electrical components

Combination of connection block and electrical connection technology					
Connection block	Connection technology	Plug/connecting cable	Connection technology	Plug/connecting cable	Connection technology
[1] CPX-M-AB-4-M12X2-5POL CPX-M-AB-4-M12X2-5POL-T CPX-M-AB-8-M12X2-5POL CPX-AB-8-M12X2-5POL	Socket, M12, 5-pin	[2] SEA-GS-7	Screw terminals	–	–
		[2] SEA-4GS-7-2.5	Screw terminals	–	–
		[2] SEA-GS-9	Screw terminals	–	–
		[2] SEA-M12-5GS-PG7	Screw terminals	–	–
		[2] SEA-GS-11-DUO	Screw terminals, for two cables	–	–
		[2] SEA-5GS-11-DUO	Screw terminals, for two cables	–	–
		[3] NEBU-...-M12G5	Socket, M8, 4-pin	–	–
		(modular system for choice of connecting cables)	Socket, M12, 5-pin	–	–
			Open cable end	–	–
		[4] NEDY-... (modular system for all types of sensor/ actuator distributor)	2x socket, M8, 3-pin	–	–
			2x socket, M8, 4-pin	–	–
			2x socket, M12, 5-pin	–	–
			2x socket, type A	–	–
			2x socket, type B	–	–
			2x socket, type C	–	–
			2x socket, plug pattern H	–	–
			2x socket, plug pattern ZB	–	–
			2x socket, plug pattern ZC	–	–
			2x open cable end	–	–
		[5] NEDY-L2R1-V1-M8G3-N-M12G4 (T-adapter)	Plug M12, 4-pin to 2x socket, M8, 3-pin	[6] SEA-GS-M8	Solder lugs
				[6] SEA-3GS-M8-S	Screw terminals
		[5] NEDY-L2R1-V1-M12G5-N-M12G4 (T-adapter)	Plug M12, 4-pin to 2x socket M12, 5-pin	[7] NEBU-...-M8G3 (modular system for choice of connecting cables)	Socket, M8, 3-pin
					Socket, M8, 4-pin
					Socket, M12, 5-pin
					Open cable end
				[6] SEA-GS-7	Screw terminals
				[6] SEA-4GS-7-2.5	Screw terminals
				[6] SEA-GS-9	Screw terminals
				[6] SEA-M12-5GS-PG7	Screw terminals
[6] SEA-GS-11-DUO	Screw terminals, for two cables				
[6] SEA-5GS-11-DUO	Screw terminals, for two cables				
[7] NEBU-...-M12G5 (modular system for choice of connecting cables)	Socket, M8, 4-pin				
	Socket, M12, 5-pin				
	Open cable end				

Key features – Electrical components

Electrical connection – Connection block with M12, 4-pin connection

CPX-P-AB-4XM12-4POL

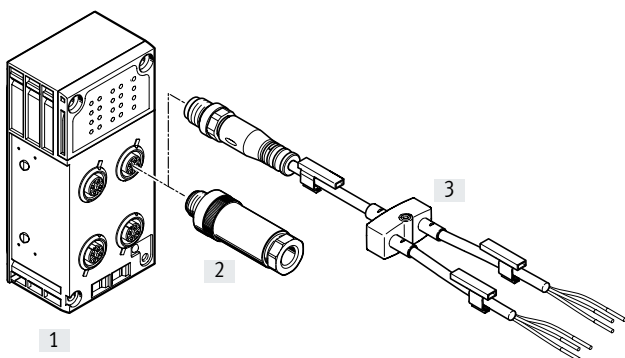

- Suitable for self-assembly and sturdy
- 4 sockets
- 4-pin design per connection

Combination of connection block and electrical connection technology

Connection block	Connection technology	Plug/connecting cable	Connection technology
[1] CPX-P-AB-4XM12-4POL	Socket, M12, 4-pin	[2] SEA-GS-HAR-4POL	Insulation displacement connector
		[2] SEA-4GS-7-2.5	Screw terminal
		[2] SEA-GS-7	Screw terminal
		[2] SEA-GS-9	Screw terminal
		[3] NEDY-... (modular system for all types of sensor/actuator distributor)	2x open cable end

Electrical connection – Connection block with clamping connector

CPX-P-AB-2XKL-8POL

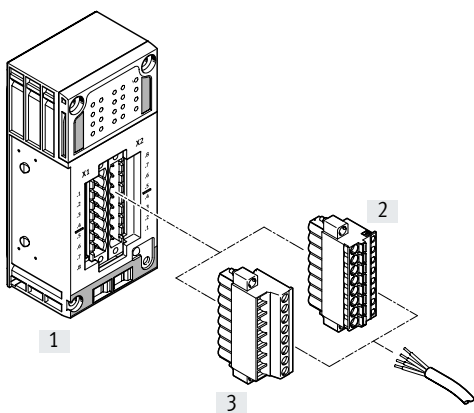

- Quick connection technology for use in control cabinets
- Spring-loaded terminals or screw terminals
- Wire cross sections 0.2 ... 2.5 mm²

Combination of connection block and electrical connection technology

Connection block	Connection technology	Plug/connecting cable	Connection technology
[1] CPX-P-AB-2XKL-8POL	Plug, 8-pin	[2] NECU-L3G8-C1	Spring-loaded terminals
		[3] NECU-L3G8-C2	Screw terminals

Key features – Electrical components

Electrical connection – Connection block

CPX-AB-4-M12-8POL with connection socket M12, 8-pin

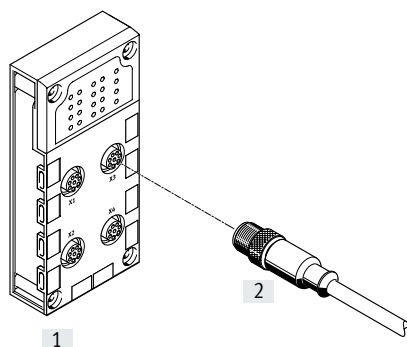

- Connection to cylinder/valve combinations with max. 3 inputs and 2 outputs
- 4 sockets
- 8-pin design per socket

Combination of connection block and electrical connection technology

Connection block	Connection technology	Plug/connecting cable	Connection technology
[1] CPX-AB-4-M12-8POL	Socket, M12, 8-pin	[2] KM12-8GD8GS-2-PU (pre-assembled connecting cable)	Socket, M12, 8-pin

CPX-AB-8-KL-4POL, CPX-2ZE2DA with spring-loaded terminal connection

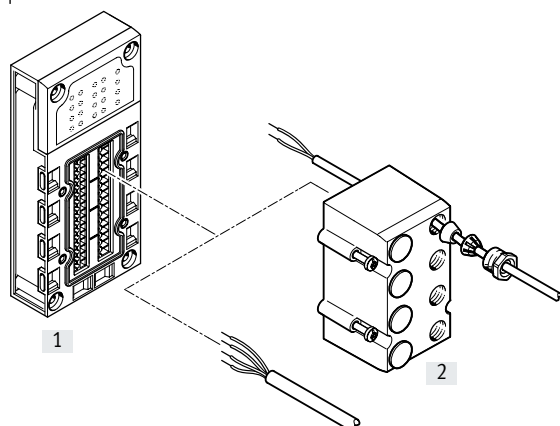

- Quick connection technology for use in control cabinets
- 32 spring-loaded terminals
- 4 spring-loaded terminals per channel
- Wire cross-sections 0.05 ... 1.5 mm²
- Optional cover with fittings for IP65, IP67 connection
 - 8 through-holes M9
 - 1 through-hole M16
 - Blanking plug
 - For I/O distributors, control desks or individual sensors/actuators

Combination of connection block and electrical connection technology

Connection block	Connection technology	Plug/connecting cable	Connection technology
[1] CPX-AB-8-KL-4POL CPX-2ZE2DA	Spring-loaded terminals, 32-pin	[2] AK-8KL (cover)	–

Key features – Electrical components

Electrical connection – Connection block

CPX-AB-1-SUB-BU-25POL with Sub-D connection, 25-pin

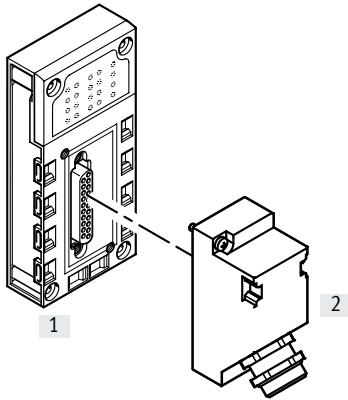

- Multi-pin connection for I/O distributor or control desk
- One socket
- 25-pin design

Combination of connection block and electrical connection technology

Connection block	Connection technology	Plug/connecting cable	Connection technology
[1] CPX-AB-1-SUB-BU-25POL	Sub-D socket, 25-pin	[2] SD-SUB-D-ST25	Crimp contacts

Key features – Mounting

Hood

Description

→ Page 248

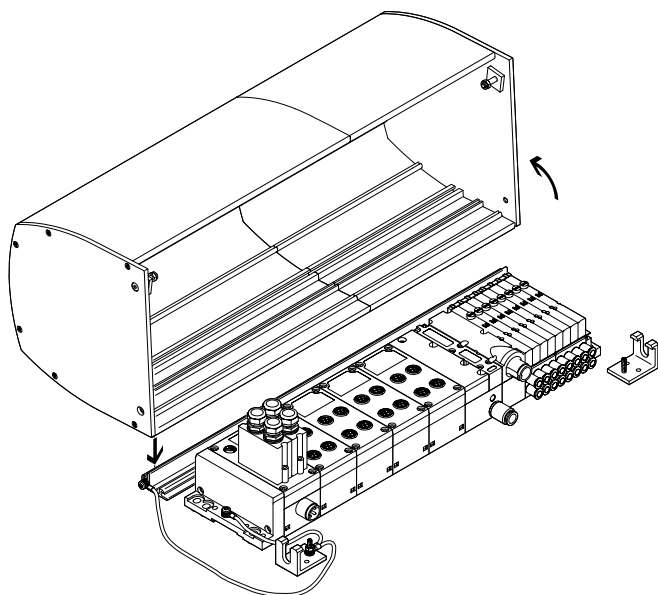

The CPX hood CAFC is a space- and cost-saving alternative to a control cabinet.

It is designed as an extruded aluminum profile and is installed on a mounting plate.

The valve terminal (CPX with MPA-S or MPA-L) is well protected and is quick to install without the need for complex cabinet through feed for connecting cables and tubing.

The rail and the two mounting brackets are mounted on a base plate. The hood is attached to the retaining rail and secured with two screws. There is also a stand-by position (latching of the hood in the open position).

The hood is locked using two side screws (which meet the requirements for a special lock in compliance with ATEX).

The CPX hood can be ordered online using the valve terminal configurator.

Advantages of the CPX hood

- Impact protection (min. 7 J) for the modules underneath in combination with a suitable mounting plate provided by the user
- Protection against electrostatic discharge by using electrically conductive materials and the option of connecting an earth wire
- Protection against disconnection of live plugs (by securing the hood with at least one special fastener to EN 60079-0, 9.2 and 20)
- UV protection for the CPX and MPA modules underneath

Points to note when using the CPX hood

- Only in combination with valve terminal MPA-S and MPA-L
- No bus nodes with push-pull connection (CPX-M-FB45)
- CPX power supply via angled plugs, no T plugs, no push-pull
- Electrical supply plate/additional supply only possible with angled plug
- No MPA vertical stacking
- Use of larger fittings (for tubing O.D. 12 mm and larger) only possible with the angled design
- Ducted exhaust air only with elbow connector
- The permissible ambient temperature range of the valve terminal is reduced by 5°C.

 **Note**

The CPX hood has no influence on the ATEX classification of the valve terminal or of the CPX terminal.

The CPX hood has no influence on the IP degree of protection of the valve terminal or of the CPX terminal.

The CPX hood does not protect against the effects of the weather in installations that are not in enclosed spaces.

Key features – Mounting

Hood Mounting

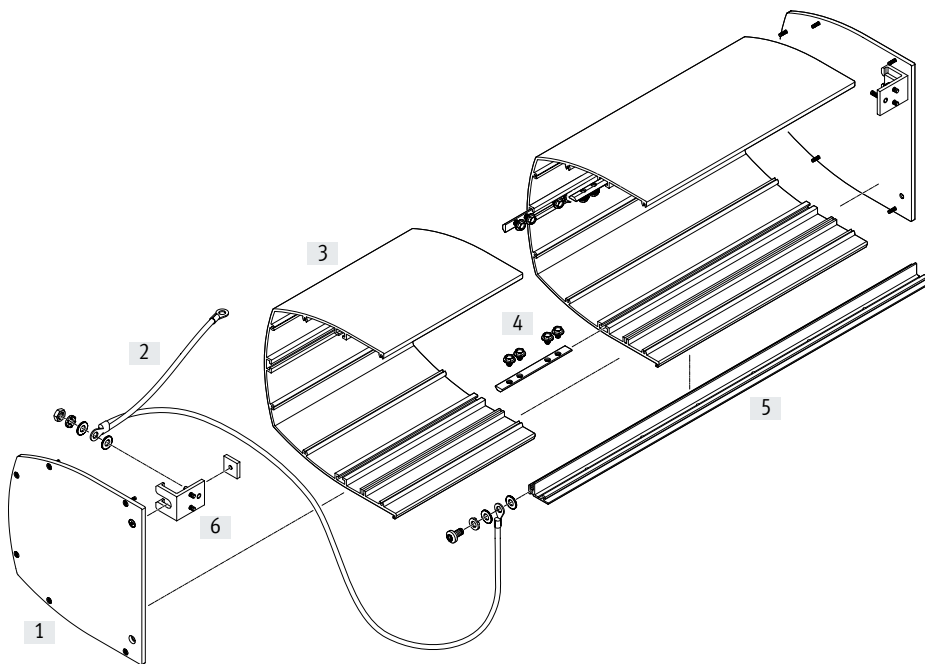

Procedure:

- Assemble the rail and mounting bracket included in the mounting kit
- Attach the earthing cable
- Assemble the hood (if applicable, screw together several hood sections and attach the side covers)
- Attach and secure the hood

- [1] Side cover
- [2] Earthing cable
- [3] Hood section
- [4] Slot nut with screws, for joining the hood sections
- [5] Rail
- [6] Mounting bracket

Technical data

Weight:

- Hood: approx. 500 g per 100 mm of length
- Mounting rail: approx. 550 g per 1000 mm of length
- Side pieces: approx. 500 g per side

- Ambient temperature –5 ... +50°C

- RoHS-compliant

Plug coding

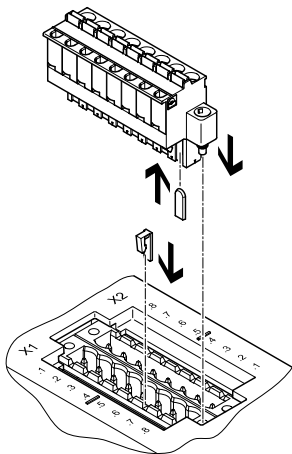

The connection block CPX-P-AB-2XKL-8POL and the sockets NECU-L3G8 can be matched to one another using the coding elements CPX-P-KDS-AB-2XKL.

This reduces the possibility of the socket being plugged back into an incorrect slot after being disconnected from the CPX terminal (connection safeguard).

Key features – Mounting

Extension

Functional principle

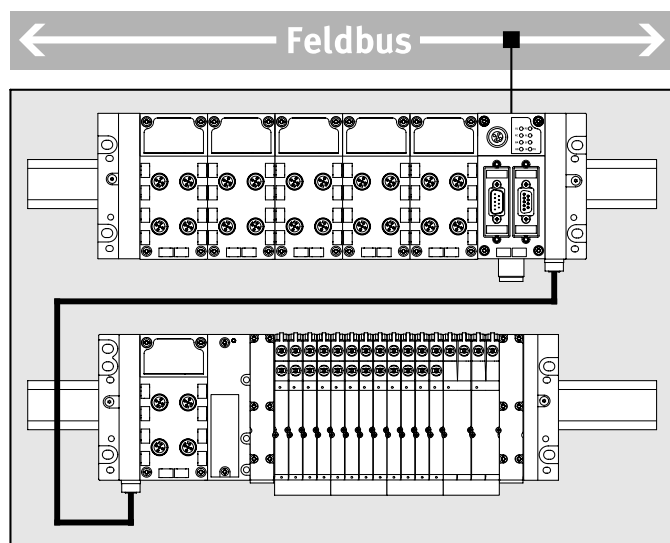

The extension enables the CPX terminal to be separated into or configured as two interconnected units (series). The two parts are controlled by a common bus node or control block. A comprehensive CPX terminal can fit into limited installation spaces more easily as two more compact units.

Applications:

- Installation in a control cabinet on two levels, one beneath the other
- Installation in two separate control cabinets
- Installation of part of the CPX terminal inside and part outside the control cabinet
- Spatial separation of electrics and pneumatics

Performance limits

- A maximum of 10 CPX modules can be installed in the first row
 - A maximum of 8 CPX modules and a pneumatic interface can be installed in the second row
- The number of CPX modules and solenoid coils is also limited by:
- the address space made available by the control block/bus node
 - their address requirement
 - their current consumption

Optimisation

- The maximum possible performance or maximum number of modules can only be achieved if the following conditions are observed:
- The control block/bus node is installed in the first row, on the far right, on an interlinking block with system supply
 - The connecting cable between the first and second row is max. 2 m long
 - An interlinking block with additional supply for valves is situated in the second row

Configuration rules

- The extension limits the power supply for the sensors and electronics for the CPX terminal as a whole as follows:
- First row max. 6 A
 - Second row max. 2 A
 - First and second row together, max. 6 A
- If the 3 m connecting cable is used, the following restrictions apply:
- There can only be one CPX module in the second row
 - An additional supply for valves is required in order to connect a valve terminal
- When positioning output modules in the second row, a corresponding power supply in the second row is required:
- Install an interlinking block with additional supply for outputs in the second row to the left of the first output module

Key features – Mounting

Extension – Permissible CPX modules	Type	First row	Second row
Control blocks	CPX-CEC	Permissible, at least one control block or bus node required	Not permissible
Bus node	CPX-FB CPX-M-FB	Permissible, at least one control block or bus node required	Not permissible
Gateway	CPX-IOT	Not permissible	Not permissible
Technology modules	CPX-CP CPX-CTEL CPX-CTEL-2 CPX-CM-HPP CPX-CMAX CPX-CMPX CPX-CMIX	Permissible	Not permissible
Input/output modules	CPX	Permissible	Permissible
PROFIsafe shut-off module	CPX-FVDA-P2	Not permissible	Not permissible
Interlinking block/end plate with system supply	CPX-EPL-EV-S CPX-GE-EV-S CPX-M-GE-EV-S	Permissible, at least one interlinking block/end plate with system supply required	Not permissible
Interlinking block with additional supply	CPX-GE-EV-Z CPX-M-GE-EV-Z CPX-GE-EV-V	Permissible	Permissible
Interlinking block without power supply	CPX-GE-EV CPX-M-GE-EV	Permissible	Permissible
Interlinking block with system forwarding	CPX-M-GE-EV-W	Not permissible	Not permissible
Pneumatic interface	VMPA-FB	Not permissible	Permissible
	VMPAL-EPL-CPX	Not permissible	Permissible
	VABA-S6-1	Not permissible	Permissible
	VABA-S6-1...CB	Not permissible	Not permissible

Key features – Mounting

Extension – Maximum number of CPX modules/solenoid coils		
Special features of the design	First row	Second row
CPX terminal with valve terminal		
Connecting cable 3 m	10 CPX modules	Valve terminal MPA-S with: <ul style="list-style-type: none"> • Pneumatic interface for CPX metal interlinking module • Electrical supply plate VMPA-FB-SP directly after the pneumatic interface • Electronics modules with galvanic isolation • 128 solenoid coils (64 valve positions)
		Valve terminal VTSA/VTSA-F with: <ul style="list-style-type: none"> • 1 CPX module with interlinking block with additional supply for valves • 32 solenoid coils (32 valve positions)
CPX terminal without valve terminal		
• Control block/bus node not in position on the far right of the first row	10 CPX modules	• 2 ... 5 CPX modules, depending on the control block/bus node used
• Control block/bus node in position on the far right of the first row	10 CPX modules	• 4 ... 8 CPX modules, depending on the control block/bus node used
CPX terminal with valve terminal MPA-S		
–	10 CPX modules	• 2 ... 5 CPX modules and connection blocks MPA-S, depending on the control block/bus node used
• Electrical supply plates VMPA-FB-SP • Electronics modules with galvanic isolation	10 CPX modules	• 2 ... 5 CPX modules, depending on the control block/bus node used • Up to 128 solenoid coils (64 valve positions)
• Control block/bus node in position on the far right of the first row • CPX-FB11 or CPX-CEC not possible	10 CPX modules	• 4 ... 5 CPX modules and connection blocks MPA-S, depending on the control block/bus node used
• CPX-FB13 or CPX-FB36 • Control block/bus node in position on the far right of the first row • Interlinking block with system supply in position on the far right of the first row	10 CPX modules	• 8 CPX modules and connection blocks MPA-S
• CPX-FB13 or CPX-FB36 • Control block/bus node in position on the far right of the first row • Interlinking block with additional supply for valves in position on the far right of the first row	10 CPX modules	• 8 CPX modules and connection blocks MPA-S
• CPX-FB13 or CPX-FB36 • Control block/bus node in position on the far right of the first row • Interlinking block with additional supply for valves in second row	10 CPX modules	• 8 CPX modules and connection blocks MPA-S

Key features – Mounting

Extension – Maximum number of CPX modules/solenoid coils Special features of the design	First row	Second row
CPX terminal with valve terminal MPA-L		
–	10 CPX modules	<ul style="list-style-type: none"> • 2 CPX modules (at least one CPX module required) • 16 solenoid coils (valve widths 10 mm and 14 mm) or 8 solenoid coils (valve width 20 mm)
• Interlinking block with additional supply for valves in second row	10 CPX modules	<ul style="list-style-type: none"> • 2 CPX modules (at least one CPX module required) • 32 solenoid coils (32 valve positions)
CPX terminal with valve terminal VTSA/VTSA-F		
–	10 CPX modules	<ul style="list-style-type: none"> • 2 CPX modules • 12 solenoid coils (valve widths 18 mm, 26 mm and 42 mm) or 6 solenoid coils (valve widths 52 mm and 65 mm)
• Interlinking block with additional supply for valves in second row	10 CPX modules	<ul style="list-style-type: none"> • 2 CPX modules • 32 solenoid coils (32 valve positions)

Key features – Mounting

Mounting options

Valve terminals with CPX terminal support different mounting options for direct machine mounting with a high degree of protection and control cabinet installation.

H-rail mounting

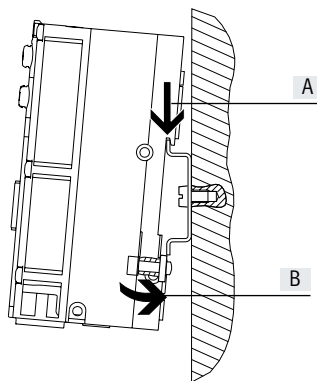

The H-rail mounting is part of the rear profile of the CPX interlinking blocks. The CPX terminal can be attached to the H-rail using the H-rail mounting kit. The CPX terminal is first hooked onto the H-rail (see arrow [A]),

then swivelled onto the H-rail and secured in place with the clamping element (see arrow [B]).

The optional earthing plate enables a connection to be established to the machine potential/earth in one easy step.

The following mounting kit is needed for H-rail mounting:

- CPX-CPA-BG-NRH

This facilitates mounting of the CPX terminal on H-rails to EN 60715.

An additional mounting kit may be required for combination with valve terminals.

Wall mounting

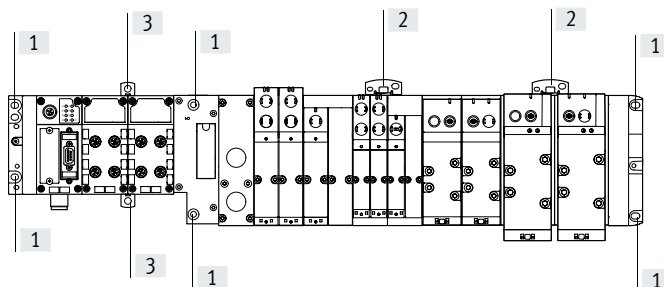

The end plates of the CPX terminal, the valve terminal and the pneumatic interface include mounting holes [1] for wall mounting. Additional mountings [2] for the CPX terminal are available for longer valve terminals.

These mountings differ depending on the design of the CPX terminal (plastic or metal).

In the case of 4 and more interlinking blocks, additional wall mountings must be used every 100 ...150 mm:

- Type CPX-M-BG-RW (metal design). These wall mountings are screwed in at the top on the CPX module.
- Type CPX-BG-RW (plastic design). These wall mountings are hooked in at the top and bottom between the CPX modules.

Key features – Mounting

CPX terminal in plastic design

Additional mountings

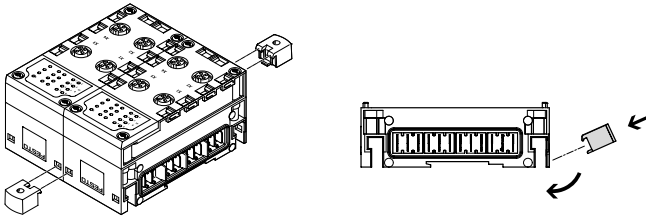

For longer valve terminals, there are additional mounting components for the CPX terminal that can be fitted between two modules.

Note

For CPX terminals with 4 or more interlinking blocks, you need additional mounting components of type CPX-BG-RW every 100 or 150 mm. These are supplied pre-assembled.

Interlinking with tie rods

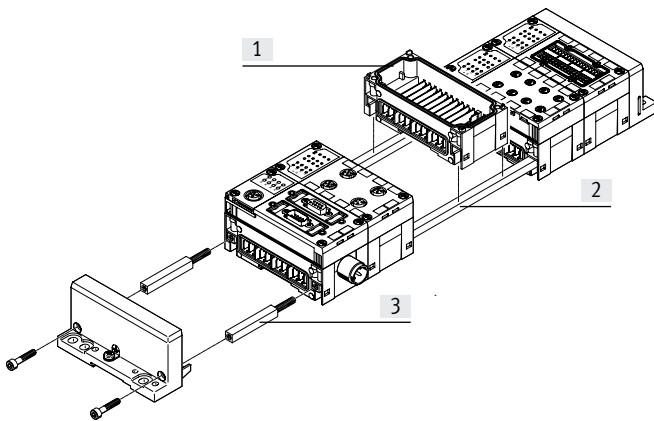

The mechanical connection between the CPX modules is created using special tie rods [2]. The entire unit can be assembled using two screws in the end plates.

The tie rod ensures that the unit has a high mechanical load-bearing capacity and is therefore the mechanical “backbone” of the CPX terminal.

The open design allows interlinking blocks [1] to be replaced when already mounted.

With the tie rod extension kit [3] an extra module can be added to the CPX terminal.

CPX terminal in metal design

Additional mountings

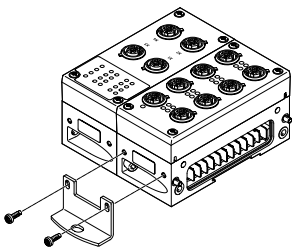

For longer valve terminals, there are additional mounting brackets for the CPX terminal that can be screwed onto the interlinking blocks.

The mounting bracket CPX-M-BG-VT-2X enables a CPX terminal with valve terminal VTSA/VTSA-F/VTSA-F-CB to be mounted on a support system.

Note

In the case of CPX terminals with 4 or more interlinking blocks, additional mounting brackets of the type CPX-M-BG-RW must be used every 100 or 150 mm. These are supplied pre-assembled.

Linking with screws

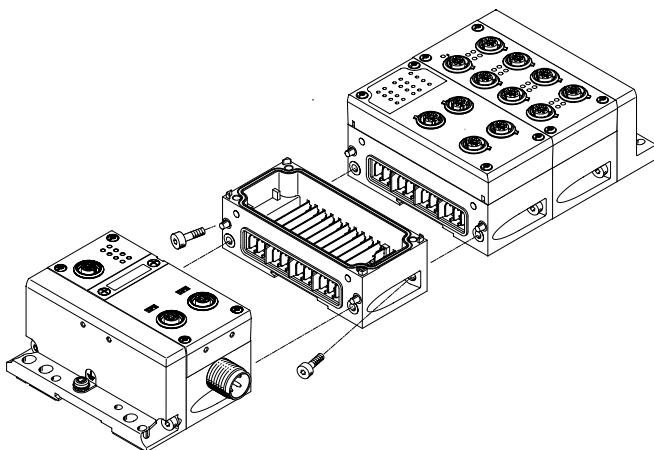

The CPX modules are mechanically connected using an angled fitting. The CPX terminal can thus be expanded at any time.

Key features – Power supply

Power supply concept

General

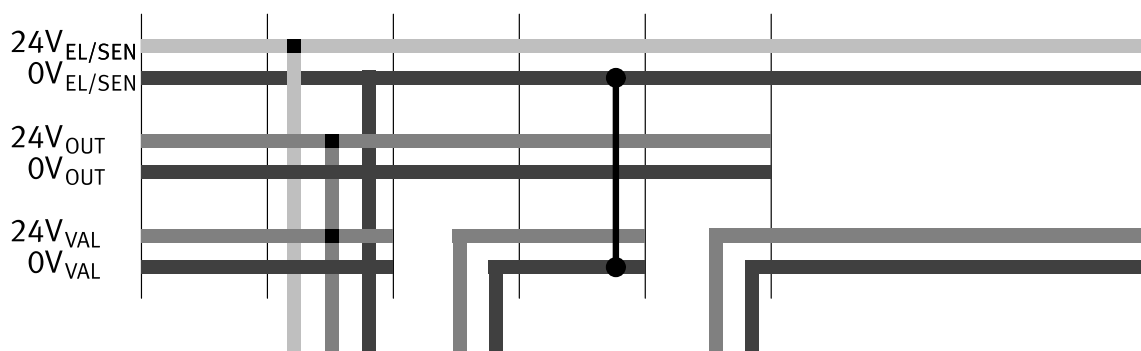
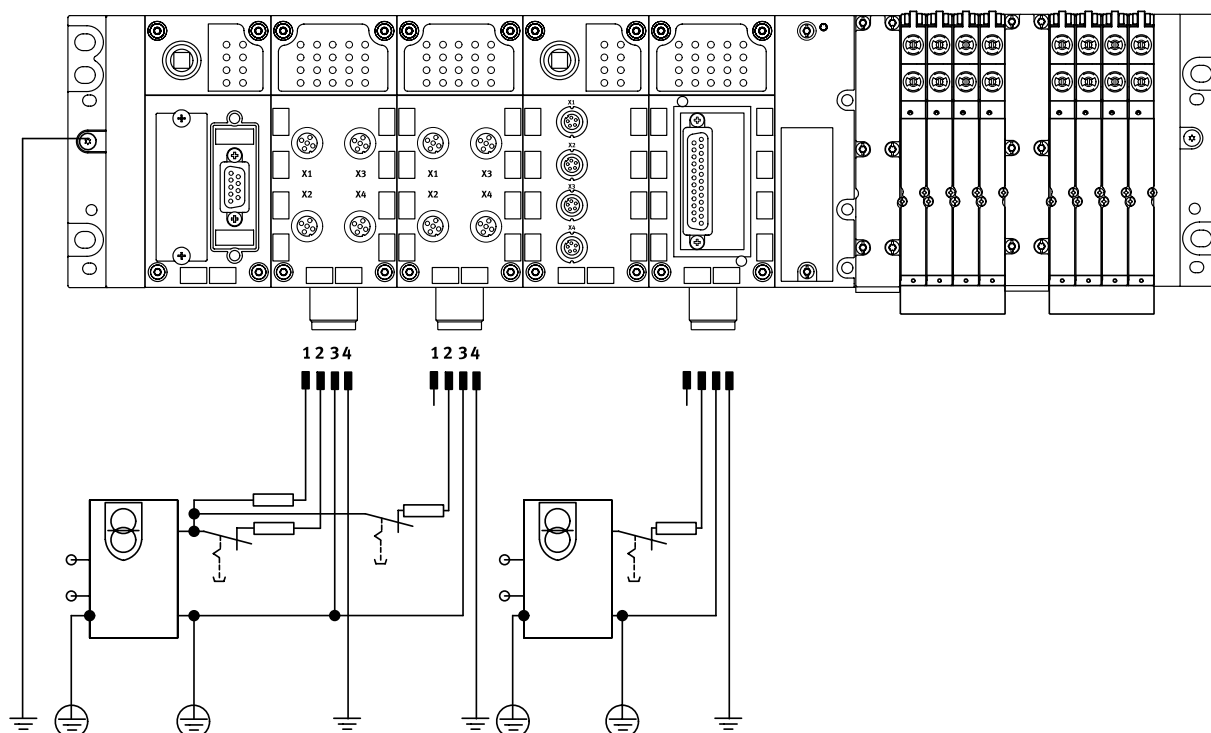

The use of decentralised devices on the fieldbus – particularly with a high degree of protection for direct machine mounting – demands a flexible power supply concept.

A valve terminal with CPX is, in principle, supplied with all voltages via a single connection.

A distinction is made between the supply for

- Electronics plus sensors
- Valves plus actuators

in this case.

Selectable connection technology:

- M18
- 7/8"
- M12x1
- AIDA push-pull

Interlinking blocks

Interlinking blocks represent the backbone of the CPX terminal with all supply lines. They provide the power supply for the modules used on them as well as their bus connections.

Many applications require the CPX terminal to be separated into voltage zones. This applies in particular to the separate disconnection of solenoid coils and outputs.

The interlinking blocks provide either an easy-to-install central power supply for the entire CPX terminal or galvanically isolated, all-pin disconnectable potential groups/voltage segments.

Key features – Power supply

Interlinking blocks

With system supply

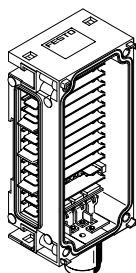

Plastic design

- CPX-GE-EV-S
- CPX-GE-EV-S-7/8-4POL
- CPX-GE-EV-S-7/8-5POL

Metal design

- CPX-M-GE-EV-S-7/8-CIP-4P
- CPX-M-GE-EV-S-7/8-5POL
- CPX-M-GE-EV-S-M12-5POL
- CPX-M-GE-EV-S-PP-5POL

Connection technology

- M18, 4-pin
- 7/8" 4-pin
- 7/8" 5-pin

Connection technology

- 7/8" 4-pin
- 7/8" 5-pin
- M12x1, L-coded, 5-pin
- AIDA push-pull, 5-pin

Power supply

- For CPX terminal modules and connected sensors
- For valves that are connected to the CPX terminal via a pneumatic interface
- For actuators that are connected to the output modules of the CPX terminal

Without power supply

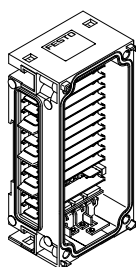

Plastic design

- CPX-GE-EV

Metal design

- CPX-M-GE-EV
- CPX-M-GE-EV-FVO

-

-

-

With additional supply for outputs

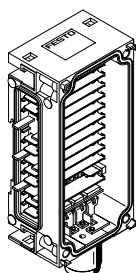

Plastic design

- CPX-GE-EV-Z
- CPX-GE-EV-Z-7/8-4POL
- CPX-GE-EV-Z-7/8-5POL

Metal design

- CPX-M-GE-EV-Z-7/8-5POL
- CPX-M-GE-EV-Z-PP-5POL

Connection technology

- M18, 4-pin
- 7/8" 4-pin
- 7/8" 5-pin

Connection technology

- 7/8" 5-pin
- AIDA push-pull, 5-pin

Power supply

- For actuators that are connected to output modules of the CPX terminal

With additional supply for valves

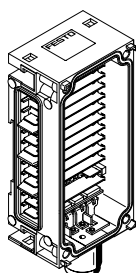

Plastic design

- CPX-GE-EV-V
- CPX-GE-EV-V-7/8-4POL

Connection technology

- M18, 4-pin
- 7/8" 4-pin

Power supply

- For valves that are connected to the CPX terminal via a pneumatic interface

-  - **Note**

For 7/8":

- Commercially available accessories are often limited to max. 8 A

-  - **Note**

The valve terminal MPA-S has either a 7/8" 5-pin, 7/8" 4-pin, 3-pin M18 or 5-pin AIDA push-pull power supply for one or more valve voltage zones. Galvanically isolated, all-pin disconnectable with voltage monitoring in the following MPA module.

-  - **Note**

Suitable versions of the interlinking blocks with M18 and 7/8", 5-pin connection are available (CPX-GE-EV-...-VL and CPX-M-GE-EV-...-VL) for use in ATEX environments as per certification (→ page 49). The maximum current supply for these interlinking blocks is 8 A.

Key features – Power supply

Interlinking blocks

With system forwarding

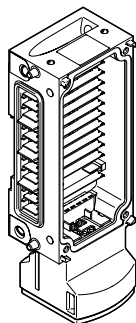

Metal design

- CPX-M-GE-EV-W-M12-5POL

Connection technology

- M12x1, L-coded, 5-pin

Voltage transmission

- For a further CPX terminal

Key features – Diagnostics

Diagnostics

System performance

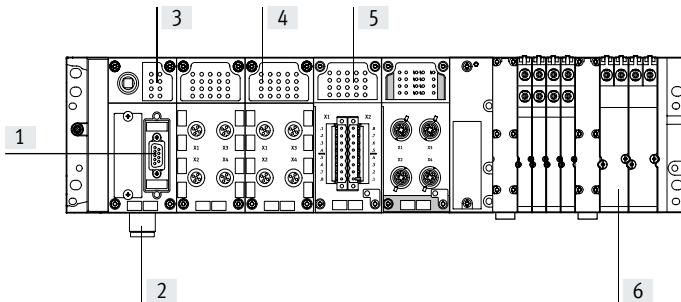

- [1] Diagnostics via bus interface
- [2] Undervoltage monitoring
- [3] Diagnostic overview LED
 - Fieldbus status
 - CPX status
- [4] Status and diagnostic LED for module and I/O channels
- [5] Module and channel-specific diagnostics
- [6] Valve-specific diagnostic module and solenoid coils
- [7] MPA pressure sensor – integrated solution on the fieldbus
 - Pre-assembled for channels 1, 3, 5 and external pressures

Detailed diagnostic functions are needed in order to quickly locate the causes of errors in the electrical installation and therefore reduce downtimes in production plants.

A basic distinction is made between on-the-spot diagnostics using LEDs or a diagnostic interface and diagnostics using a bus interface.

The CPX terminal supports on-the-spot diagnostics via a row of LEDs. This is separate from the connection area and therefore provides good visual access to status and diagnostic information.

Module and channel-specific diagnostics are supported, for example:

- Undervoltage detection for outputs and valves
- Short circuit detection for sensors, outputs and valves
- Open-load detection for a missing solenoid coil
- Storage of the last 40 causes of errors with error start and error end

The diagnostic messages can be read out via the bus interface in the higher-order controller and visualised for the central recording and evaluation of error causes. This is done using the individual fieldbus-specific channels. CPX-CECs also offer the option of access via the integrated Ethernet interface (remote maintenance via PC/web applications).

Overview of LEDs on the bus node

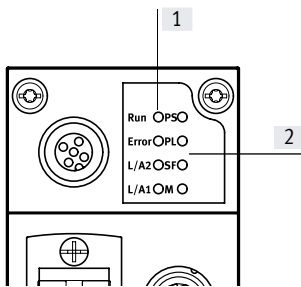

[1] Fieldbus-specific LEDs
On each bus node, a maximum of 4 fieldbus-specific LEDs display the fieldbus communication status of the CPX terminal with the higher-order controller.

[2] CPX-specific LEDs
A further 4 CPX-specific LEDs provide non-fieldbus-specific information about the status of the CPX terminal, for example:

- Power system
- Power load
- System fault
- Modify parameters

Input/output module status and diagnostic LEDs

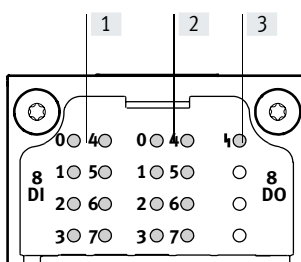

[1] Status LEDs for the inputs and outputs
Each input and output channel is assigned a status LED.

[2] Channel-oriented diagnostic LEDs
Depending on the module design, another diagnostic LED is available for each I/O channel

[3] Group diagnostic LEDs
An LED displays the group diagnostics for each module

Key features – Diagnostics

Diagnostics

Display on a PC

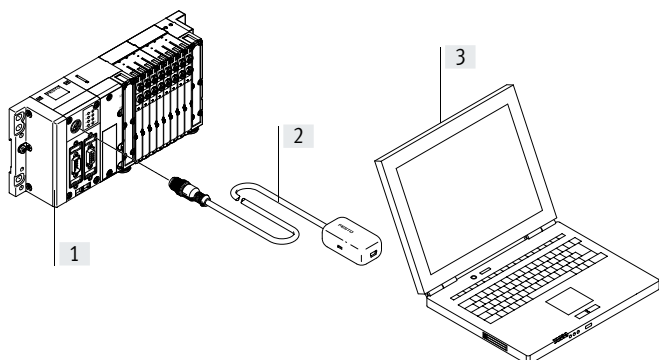

- [1] CPX terminal with valve terminal
- [2] Adapter diagnostic interface to USB
- [3] Laptop/portable device with USB interface and installed FMT software
 - Fault location and type
 - Without programming
 - Storing the configuration
 - Preparing screenshots

Data gathering via gateway

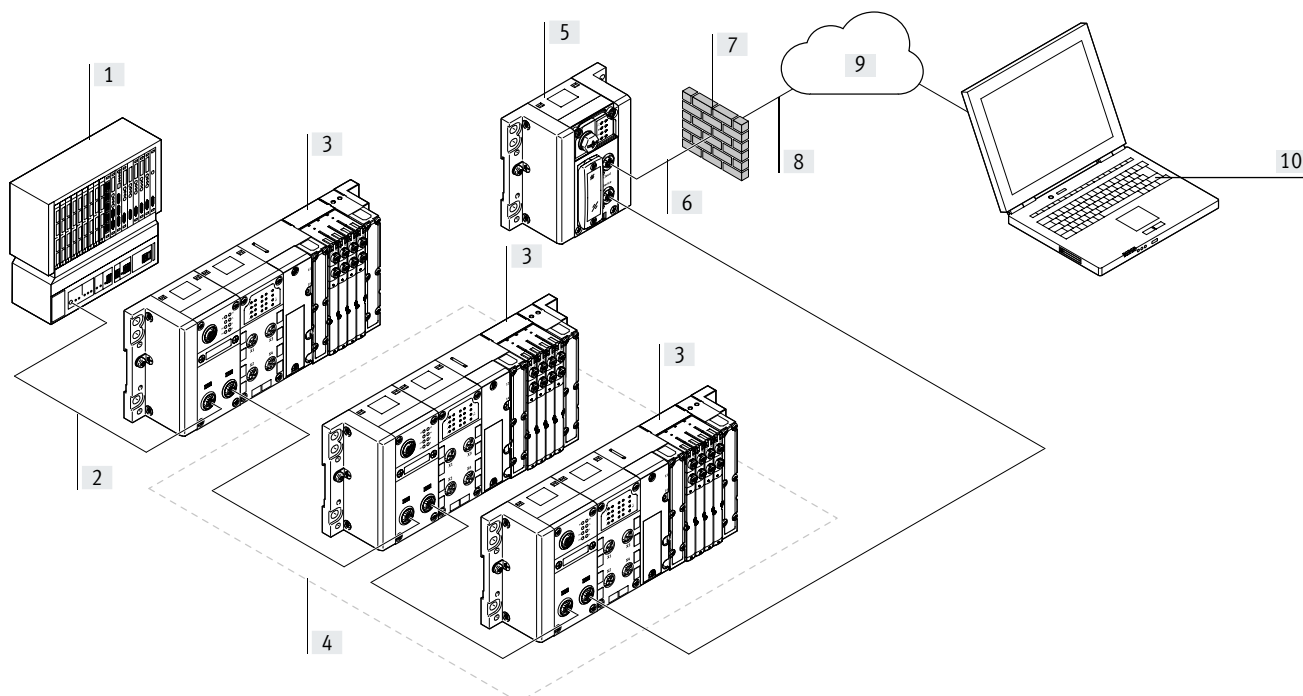

- [1] PLC to machine/system controller (no direct internet connection)
- [2] Bus system from the controller to the system parts (e.g. PROFINET)
- [3] Festo components with bus connection with serial linking
- [4] Components from which the CPX-IOT is collecting and transferring data
- [5] Gateway CPX-IOT
- [6] Internet connection
- [7] Customer firewall or other security precautions
- [8] Transferring data to a central storage location (MQTT broker) using secure protocols
- [9] Central storage location (user-specific MQTT broker) provided by Festo
- [10] Simple decentralised evaluation of data using adapted programs (apps) for the components that are being monitored

Key features – Parameterisation

Parameterisation

Changes to the application are often required during commissioning. The parameterisable characteristics of the CPX modules mean that functions can be very easily changed using configuration software. This reduces the number of modules needed and, consequently, the amount of storage space required.

It is therefore possible, for example, to reduce the input debounce time for an input module – normally 3 ms – to 0.1 ms on a "fast" input module for faster processes, or to set the response of a valve following a fieldbus interruption.

Depending on the modules used, parameterisation can be carried out via the following interfaces:

- Ethernet
- Fieldbus
- Control block direct interface (programming interface)

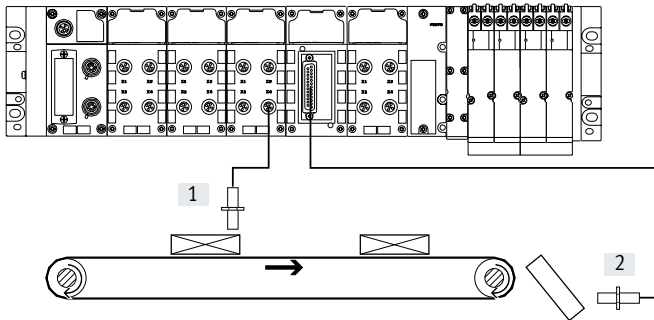

- [1] Input debounce time 3 ms
[2] Input debounce time 0.1 ms

Key features – Addressing

Addressing

The various CPX modules occupy a different number of I/O addresses within the CPX system. The maximum address space for bus nodes depends on the performance of the fieldbus systems.

Maximum system configuration:

- 1 bus node or control block
- 9 I/O modules
- 1 pneumatic interface (e.g. pneumatic interface MPA-S with up to 16 MPA connection blocks)

The maximum system configuration can be limited in individual cases by exceeding the address space.



Note

Please refer to the detailed description of the configuration/addressing rules in the technical data for CPX bus nodes.

Overview – Address space for CPX bus node and control block

	Protocol	Max. total		Max. digital		Max. analogue	
		Inputs	Outputs	Inputs	Outputs	Inputs	Outputs
CPX-CEC	<ul style="list-style-type: none"> • CODESYS Level 2 • TCP/IP • Easy IP • Modbus TCP 	512 bits	512 bits	512 DI	512 DO	32 AI	18 AO
CPX-FB11	DeviceNet	512 bits	512 bits	512 DI	512 DO	32 AI	18 AO
CPX-FB13	PROFIBUS	512 bits	512 bits	512 DI	512 DO	32 AI	18 AO
CPX-FB14	CANopen	256 bits	256 bits	64 DI (+ 64 DI)	64 DO (+ 64 DO)	8 AI (+ 8 AI)	8 AO (+ 8 AO)
CPX-FB23-24	CC-Link	512 bits	512 bits	512 DI	512 DO	32 AI	18 AO
CPX-FB36	EtherNet/IP	512 bits	512 bits	512 DI	512 DO	32 AI	18 AO
CPX-FB37	EtherCAT	512 bits	512 bits	512 DI	512 DO	32 AI	18 AO
CPX-FB39	Sercos III	512 bits	512 bits	512 DI	512 DO	32 AI	18 AO
CPX-FB40	POWERLINK	512 bits	512 bits	512 DI	512 DO	32 AI	18 AO
CPX-FB43	PROFINET RT	512 bits	512 bits	512 DI	512 DO	32 AI	18 AO
CPX-M-FB44	PROFINET RT	512 bits	512 bits	512 DI	512 DO	32 AI	18 AO
CPX-M-FB45	PROFINET RT	512 bits	512 bits	512 DI	512 DO	32 AI	18 AO



Note

The bandwidth of the bus nodes can be restricted by the choice of module and the maximum number of modules.

Example – CPX-FB43 (PROFINET RT)

	Digital inputs	Digital outputs	Remarks
1x CPX-CM-HPP	256	256	<ul style="list-style-type: none"> • The address space is occupied by 7 CPX I/O modules plus pneumatic interface • No additional modules can be configured
2x CPX-2ZE2DA	192	192	
4x CPX-16DE	64	–	
8x VMPA1	–	64	
Allocated address space	512	512	

DI = Digital inputs (1 bit)

DO = Digital outputs (1 bit)

AO = Analogue outputs (16 bits)

AI = Analogue inputs (16 bits)

Key features – Addressing

Overview – Allocated addresses for CPX modules		
	Inputs [bit]	Outputs [bit]
CPX-CP-4-FB	16, 32, 48, 64, 80, 96, 128 ¹⁾	16, 32, 48, 64, 80, 96, 128 ¹⁾
CPX-CTEL-4-M12-5POL	0, 64, 128, 192, 256 ¹⁾	0, 64, 128, 192, 256 ¹⁾
CPX-CTEL-2-M12-5POL-LK	64, 128, 192, 256 ¹⁾	64, 128, 192, 256 ¹⁾
CPX-CM-HPP	256	256
CPX-CMAX-C1-1	64	64
CPX-CMPX-C1-H1	48	48
CPX-CMIX-M1-1	48	48
CPX-4DE	4	–
CPX-8DE	8	–
CPX-8DE-D	8	–
CPX-8NDE	8	–
CPX-P-8DE-N	16	8
CPX-P-8DE-N (inputs configured as counter)	80	16
CPX-F8DE-P	48	56
CPX-16DE	16	–
CPX-M-16DE-D	16	–
CPX-L-16DE-16-KL-3POL	16	–
CPX-4DA	–	4
CPX-8DA	–	8
CPX-8DA-H	–	8
CPX-8DE-8DA	8	8
CPX-L-8DE-8DA-16-KL-3POL	8	8
CPX-2ZE2DA	96	96
CPX-4AE-4AA-H	0, 16, 32, 48, 64, 128, 144, 160, 176, 192 ¹⁾	0, 16, 32, 48, 64 ¹⁾
CPX-2AE-U-I	2 x 16	–
CPX-4AE-U-I	4 x 16	–
CPX-4AE-I	4 x 16	–
CPX-4AE-P-B2	4 x 16	–
CPX-4AE-P-D10	4 x 16	–
CPX-4AE-T	4 x 16	–
CPX-4AE-TC	4 x 16	–
CPX-2AA-U-I	–	2 x 16
CPX-FVDA-P2	48	48
VMPA1-FB-EMS-8	–	8
VMPA1-FB-EMG-8	–	8
VMPA2-FB-EMS-4	–	4
VMPA2-FB-EMG-4	–	4
VMPA1-FB-EMS-D2-8	–	8
VMPA1-FB-EMG-D2-8	–	8
VMPA2-FB-EMS-D2-4	–	4
VMPA2-FB-EMG-D2-4	–	4
VMPA-FB-PS-1	16	–
VMPA-FB-PS-3/5	16	–
VMPA-FB-PS-P1	16	–
VMPA-FB-EMG-P1	16	16
VMPAL-EPL-CPX	–	4, 8, 16, 24, 32 ¹⁾
VABA-S6-1-X1	–	8, 16, 24, 32 ¹⁾
VABA-S6-1-X2	–	8, 16, 24, 32 ¹⁾
VABA-S6-1-X2-D	8, 16, 24, 32 ¹⁾	8, 16, 24, 32 ¹⁾
VABA-S6-1-X1-CB	–	8, 16, 24 ¹⁾
VABA-S6-1-X2-CB	–	8, 16, 24 ¹⁾
VABA-S6-1-X2-F1-CB	–	8, 16, 24 ¹⁾
VABA-S6-1-X2-F2-CB	–	8, 16, 24 ¹⁾
VABA-S6-1-X1-3V-CB	–	8, 16, 24 ¹⁾
VABA-S6-1-X2-3V-CB	–	8, 16, 24 ¹⁾

1) Dependent on the DIL switch setting on the module

Data sheet

-  - Module width
50 mm



-  - **Note**

The data given here apply to the CPX system. If components that conform to lower values are used in the system, the specification for the entire system is reduced to the values for those components.

Example

Degree of protection IP65/IP67 applies only to the fully assembled system with fitted plugs or covers (which must also conform to IP65/IP67).

If components with a lower degree of protection are used, the protection level of the entire system is reduced to the degree of protection of the component with the lowest degree of protection, for example CageClamp connection block with degree of protection IP20 or MPA pneumatics with degree of protection IP65.

General technical data		
Module no.		197330
Max. number of modules ¹⁾	Control block	1
	Bus node	1
	I/O modules/CP interface/CTEL interface/electrical interface CPX-CTEL-2/multi-axis interface	9
	Pneumatic interface	1
Max. address capacity	Inputs [byte]	64
	Outputs [byte]	64
Internal cycle time	[ms]	< 1
Configuration support		Fieldbus-specific
LED displays	Bus node/control block/gateway	Up to 4 LEDs, bus-specific 4 LEDs, CPX-specific • PS = Power system • PL = Power load • SF = System fault • M = Modify parameter/forcing active
		I/O modules Min. one centralised diagnostic LED Channel-oriented status and diagnostic LED, depending on module
	Pneumatic interface	One centralised diagnostic LED Valve status LED on valve
Diagnostics		<ul style="list-style-type: none"> • Channel and module-oriented diagnostics for inputs/outputs and valves • Detection of module undervoltage for the different potential values • Storage of the last 40 errors with timestamp (acyclic access)

1) A maximum of 11 modules in total can be combined (e.g. 1 control block + 9 I/O modules + 1 pneumatic interface, or 1 control block + 1 bus node + 8 I/O modules + 1 pneumatic interface)

Data sheet

General technical data			
Module no.		197330	
Parameterisation		Diagnostic behaviour	
		Fail-safe response	
		Forcing of channels	
		Signal setup	
Commissioning support		Forcing of inputs and outputs	
Degree of protection to EN 60529		IP65, IP67	
Nominal operating voltage	[V DC]	24	
Operating voltage range	[V DC]	18 ... 30	
Power supply	Interlinking block with system supply		
	Electronics plus sensors		
	Actuators plus valves	[A]	16 (8/10 with 7/8" supply, 5-pin/4-pin)
		[A]	16 (8/10 with 7/8" supply, 5-pin/4-pin)
	Additional supply		
	Actuators	[A]	16 (8/10 with 7/8" supply, 5-pin/4-pin)
	Additional supply for valves	[A]	16 (10 with 7/8" supply, 4-pin)
Current consumption		Depending on system configuration	
Mains buffering (bus electronics only)	[ms]	10	
Power supply connection		M18, 4-pin	
		7/8" 5-pin	
		7/8" 4-pin	
		AIDA push-pull, 5-pin	
Fuse concept		Per module with electronic fuses	
Tests	Vibration test to DIN IEC 68	<ul style="list-style-type: none"> • With wall mounting: Severity level 2 • With H-rail mounting: Severity level 1 	
	Shock test to DIN IEC 68	<ul style="list-style-type: none"> • With wall mounting: Severity level 2 • With H-rail mounting: Severity level 1 	
PWIS conformity		VDMA24364-B2-L	
Immunity to interference		EN 61000-6-2 (industry)	
Emitted interference		EN 61000-6-4 (industry)	
Isolation test for galvanically isolated circuits to IEC 1131 Part 2	[V DC]	500	
Galvanic isolation of electrical voltages	[V DC]	80	
Protection against direct and indirect contact		PELV	
Materials		End plates: Die-cast aluminium	
Grid dimension	[mm]	50	
Operating and environmental conditions			
Module no.		197330	
Ambient temperature	[°C]	-5 ... +50	
Storage temperature	[°C]	-20 ... +70	

Data sheet

Certifications and approvals – Maximum values	
Module no.	197330
ATEX category gas	II 3G
Type of ignition protection for gas	Ex ec IIC T4 Gc X
Explosion-proof ambient temperature [°C]	-5 ≤ Ta ≤ +50
CE marking (see declaration of conformity) ²⁾	To EU Explosion Protection Directive (ATEX)
	To EU EMC Directive ¹⁾
	To EU RoHS Directive
UKCA marking (see declaration of conformity) ²⁾	To UK EX instructions
	To UK instructions for EMC
	To UK RoHS instructions
KC mark	KC EMC
Degree of protection to EN 60529	IP65, IP67
Certification	c UL us - Recognized (OL)
	RCM
Explosion protection certification outside the EU	EPL Gc (Ru)
	EPL Gc (GB)

1) For information about the area of use, see the EC declaration of conformity at: www.festo.com/catalogue/... → Support/Downloads.

If the devices are subject to usage restrictions in residential, commercial or light-industrial environments, further measures for the reduction of the emitted interference may be necessary.

2) Additional information at: www.festo.com/catalogue/... → Support/Downloads.

 **Note**

The values indicated represent the maximum performance limits that can be achieved with the fully assembled product. Depending on the individual components used, the val-

ue actually achieved for the overall product may be lower. You can select e.g. the individual components required to achieve the ATEX category by choosing the corre-

sponding features in the online product configurator:
→ Internet:cpx





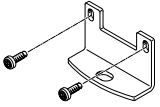
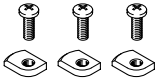
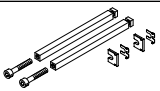
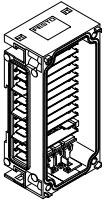
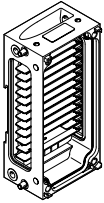

Data sheet

Weights [g]					
Control block	CEC	155	CP interface	CP	139
	CEC...V3	135	CTEL interface	CTEL	110
Bus node	–	–	Electrical interface	CTEL-2	110
	FB11	120	Axis interface	CM-HPP	140
	FB13	115	Axis controller	CMAX	140
	FB14	115	End-position controller	CMPX	140
	–	–	Measuring module	CMIX	140
	FB23-24	115	Plastic connection block	8-way, M8 3-pin	62
	–	–		8-way, M8 4-pin	65
	–	–		4-way, M12 5-pin	60
	–	–		4-way, M12 5-pin, quick lock, shielded with metal thread	87
	FB36	125		8-way, M12 5-pin	76
	FB37	125		4-way, M12 8-pin	65
	FB39	125		Spring-loaded terminal, 32-pin	75
	FB40	125		Sub-D 25-pin	72
	FB43	185		8-way, DIL switch	57
	FB44	280			
	FB45	280			
Gateway	IOT	130	Connection block for NAMUR and HART module	4-way, M12 4-pin Clamping connector 8-pin	120 100
I/O module	4 digital outputs	42	Metal connection block	4-way, M12 5-pin	112
	4 digital inputs	39		4-way, M12 5-pin, pulsed sensor supply	110
	8 digital inputs	39		8-way, M12 5-pin	152
	8 digital inputs, positive logic (PNP), enhanced diagnostic function	45	Plastic interlinking block	Without power supply	108
	8 digital inputs, negative logic (NPN)	40		System supply	125
	8 digital inputs to NAMUR	100	Interlinking block, metal	Without power supply	169
	16 digital inputs, internal electronic fuse per module	41		System supply, 7/8" 4-pin	228
	16 digital inputs, internal electronic fuse per channel pair, for CPX in metal	46		System supply, 7/8" 5-pin	187
				System supply, M12x1	279
				System supply, push-pull	279
	16 digital inputs, for CPX in plastic, including interlinking block and connection block with spring-loaded terminals	167		System forwarding, M12x1	279
	8 digital inputs, 8 digital outputs	48	Tie rods	1-way	41
	8 digital inputs, 8 digital outputs, for CPX in plastic, including interlinking block and connection block with spring-loaded terminals	171		2-way	71
	8 digital outputs, power supply 0.5 A per channel	49		3-way	97
	8 digital outputs, power supply 2.1 A per channel pair	48		4-way	127
	2 analogue current or voltage inputs	48		5-way	156
	4 analogue current inputs	47		6-way	173
	2 analogue current or voltage outputs	49		7-way	199
				8-way	247
				9-way	274
				10-way	301
	4 analogue inputs/outputs, HART	77.4	End plate for plastic design	Left-hand	110
	2 or 4 analogue temperature inputs	47		Left-hand, with system supply	145
4 analogue temperature inputs, with 2-wire connection for a PT1000 sensor for cold junction compensation	46	Right-hand		110	
4 analogue pressure inputs	115	End plate for metal design	Left-hand	113	
			Right-hand	113	
PROFIsafe	Shut-off module	50	End plate with extension	Left-hand	190
	Input module	46		Right-hand	175
Counter module	2ZE2DA	130	Pneumatic interface	MPA-S	238.4
				VTSA/VTSA-F	590
				VTSA-F-CB without voltage zones	560
				VTSA-F-CB with safe voltage zones	734
				VTSA-F-CB with safe voltage zones and power supply for external consuming devices	754
				VTSA-F-CB with external power supply	580

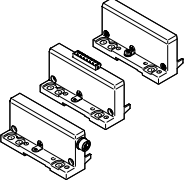
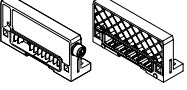

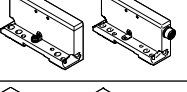
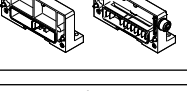
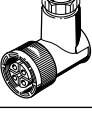
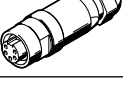
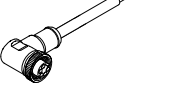
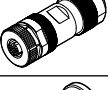

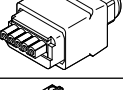
Data sheet

Ordering data – Accessories		Part no.	Type
Designation			
Mounting			
	Attachment for wall mounting (for long valve terminals, 10 pieces), design for plastic manifold sub-bases	529040	CPX-BG-RW-10x
	Attachment for wall mounting, version for metal manifold sub-bases	2 mounting brackets, 4 screws	550217 CPX-M-BG-RW-2X
		1 mounting bracket, 2 screws	2721419 CPX-M-BG-VT-2X
	Mounting for H-rail	CPX without pneumatic components	526032 CPX-CPA-BG-NRH
		CPX-VTSA	
		CPX-VTSA-F	
		CPX-MPA	
Tie rod			
	Tie rod CPX	Extension, 1 module	525418 CPX-ZA-1-E
		1-module	195718 CPX-ZA-1
		2-module	195720 CPX-ZA-2
		3-module	195722 CPX-ZA-3
		4-module	195724 CPX-ZA-4
		5-module	195726 CPX-ZA-5
		6-module	195728 CPX-ZA-6
		7-module	195730 CPX-ZA-7
		8-module	195732 CPX-ZA-8
		9-module	195734 CPX-ZA-9
10-module	195736 CPX-ZA-10		
Plastic interlinking block			
	Without power supply	–	195742 CPX-GE-EV
	With system supply	M18	195746 CPX-GE-EV-S
		M18, for ATEX environment	8022170 CPX-GE-EV-S-VL
		7/8" – 4-pin	541248 CPX-GE-EV-S-7/8-4POL
		7/8" – 5-pin	541244 CPX-GE-EV-S-7/8-5POL
		7/8" – 5-pin, for ATEX environment	8022172 CPX-GE-EV-S-7/8-5POL-VL
	With additional supply for outputs	M18	195744 CPX-GE-EV-Z
		M18, for ATEX environment	8022166 CPX-GE-EV-Z-VL
		7/8" – 4-pin	541250 CPX-GE-EV-Z-7/8-4POL
		7/8" – 5-pin	541246 CPX-GE-EV-Z-7/8-5POL
		7/8" – 5-pin, for ATEX environment	8022173 CPX-GE-EV-Z-7/8-5POL-VL
	With additional supply for valves	M18	533577 CPX-GE-EV-V
M18, for ATEX environment		8022171 CPX-GE-EV-V-VL	
7/8" – 4-pin		541252 CPX-GE-EV-V-7/8-4POL	
Interlinking block, metal			
	Without power supply	–	550206 CPX-M-GE-EV
		For CPX-FVDA-P2 only	567806 CPX-M-GE-EV-FVO
	With system supply	7/8" – 4-pin	568956 CPX-M-GE-EV-S-7/8-CIP-4P
		7/8" – 5-pin	550208 CPX-M-GE-EV-S-7/8-5POL
		7/8" – 5-pin, for ATEX environment	8022165 CPX-M-GE-EV-S-7/8-5POL-VL
		M12x1, L-coded, 5-pin	8098392 CPX-M-GE-EV-S-M12-5POL
		Push-pull – 5-pin	563057 CPX-M-GE-EV-S-PP-5POL
		7/8" – 5-pin	550210 CPX-M-GE-EV-Z-7/8-5POL
	With additional supply for outputs	7/8" – 5-pin, for ATEX environment	8022158 CPX-M-GE-EV-Z-7/8-5POL-VL
		Push-pull – 5-pin	563058 CPX-M-GE-EV-Z-PP-5POL
		M12x1, L-coded, 5-pin	8098391 CPX-M-GE-EV-W-M12-5POL

Data sheet

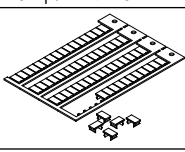
Ordering data – Accessories				
Designation			Part no.	Type
Mounting accessories				
	Screws for mounting the bus node/connection block on the plastic interlinking block	Bus node/metal connection block	550218	CPX-DPT-30X32-S-4X
	Screws for mounting the bus node/connection block on the metal interlinking block	Bus node/plastic connection block	550219	CPX-M-M3x22-4x
		Bus node/metal connection block	550216	CPX-M-M3x22-S-4x
End plates for plastic design				
	Left-hand end plate	–	195716	CPX-EPL-EV
		With system supply	576315	CPX-EPL-EV-S
		With extension	576314	CPX-EPL-EV-X
	Right-hand end plate	–	195714	CPX-EPR-EV
		With extension	576313	CPX-EPR-EV-X
	Earthing component for right-hand/left-hand end plate	5 pieces	538892	CPX-EPFE-EV
End plates for metal design				
	Left-hand end plate	–	550212	CPX-M-EPL-EV
		With extension	576317	CPX-M-EPL-EV-X
	Right-hand end plate	–	550214	CPX-M-EPR-EV
		With extension	576316	CPX-M-EPR-EV-X
Power supply				
	Plug socket for mains connection M18x1, straight, 4-pin	For 1.5 mm ²	18493	NTSD-GD-9
		For 2.5 mm ²	18526	NTSD-GD-13.5
	Plug socket for mains connection M18x1, angled, 4-pin	For 1.5 mm ²	18527	NTSD-WD-9
		For 2.5 mm ²	533119	NTSD-WD-11
	Plug socket for mains connection 7/8", straight, 5-pin	0.25 ... 2.0 mm ²	543107	NECU-G78G5-C2
	Plug socket for mains connection 7/8", straight, 4-pin	0.25 ... 2.0 mm ²	543108	NECU-G78G4-C2
	Plug socket for mains connection 7/8", angled, 5-pin – open cable end, 5-wire	2 m	573855	NEBU-G78W5-K-2-N-LE5
	Power supply socket M12x1, L-coded, straight	5-pin	8166793	NECL-L12G5-C2-Q10
	Power supply plug M12x1, L-coded, straight	5-pin	8166791	NECL-S-L12G5-C2-Q10
	Power supply socket M12x1, L-coded, angled	5-pin	8166794	NECL-L12W5-C2-Q10
	Power supply plug M12x1, L-coded, angled	5-pin	8166792	NECL-S-L12W5-C2-Q10
	Push-pull power supply socket, plug pattern PP, fulfils requirements to AIDA	5-pin	5195383	NECU-M-PPG5PP-C1-PN
	Straight plug, spring-loaded terminal, for left-hand end plate with system supply	7-pin	576319	NECU-L3G7-C1

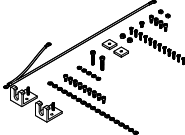
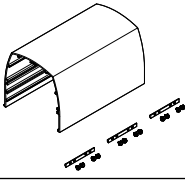
Data sheet

Ordering data – Accessories		Part no.	Type
Designation			
Inscription labels			
	Inscription labels 6x10 mm, 64 pieces, in frame	18576	IBS-6x10
Hood			
	Mounting rail for attaching the hood	1000 mm	572256 CAFC-X1-S
	Mounting kit for CPX hood		572257 CAFC-X1-BE
	Hood section for CPX terminal including mounting attachments for connecting several hood sections in series.	200 mm	572258 CAFC-X1-GAL-200
		300 mm	572259 CAFC-X1-GAL-300
User documentation			
	CPX system manual	German	526445 P.BE-CPX-SYS-DE
		English	526446 P.BE-CPX-SYS-EN
		Spanish	526447 P.BE-CPX-SYS-ES
		French	526448 P.BE-CPX-SYS-FR
		Italian	526449 P.BE-CPX-SYS-IT

Data sheet

User documentation – General information

Comprehensive user documentation is vital for the fast and reliable use of fieldbus components.

The manuals provided by Festo contain step-by-step instructions for using the CPX terminal:

1. Installation
2. Commissioning and parameterisation
3. Diagnostics

Application-oriented explanations are provided for integrating the CPX terminal in the programming and configuration software of the various controller manufacturers.

Use the order code to select the language you want.

The manuals for the configuration you have ordered are supplied automatically.

The documents can be downloaded quickly and easily from the Festo website → www.festo.com.



Overview – User documentation

Type	Title	Description
Pneumatics		
P.BE-VTSA-44-...	Valve terminals with VTSA and VTSA-F pneumatics	Instructions on assembly, installation, commissioning and diagnostics of the VTSA and VTSA-F pneumatic components.
P.BE-MPA-...	Valve terminals with MPA-S pneumatics	Instructions on assembly, installation, commissioning and diagnostics of the MPA-S pneumatic components.
MPAL-VI-...	Valve terminal	Instructions on assembly, installation, commissioning and diagnostics of the MPA-L pneumatic components.

Data sheet

Overview – User documentation		
Type	Title	Description
Electronics		
P.BE-CPX-SYS...	System description, installation and commissioning	Overview of the design, components and mode of operation of the CPX terminal; installation and commissioning instructions as well as basic principles of parameterisation.
CPX-FVDA-P2...	PROFIsafe shut-off module	Connection technology and assembly, installation and commissioning instructions for the PROFIsafe shut-off module of the type CPX-FVDA-P2.
P.BE-CPX-EA...	CPX-EA modules, digital	Connection technology and assembly, installation and commissioning instructions for digital input and output modules of type CPX... as well as the VTSA/VTSA-F and MPA-S/L pneumatic interface.
P.BE-CPX-P-EA...	Input module CPX-P-8DE-N	Connection technology and assembly, installation and commissioning instructions for the digital input module for NAMUR sensors of type CPX-P-8DE-N.
CPX-F8DE-P...	Input module CPX-F8DE-N	Connection technology and assembly, installation and commissioning instructions for the PROFIsafe input module of type CPX-F8DE-P.
P.BE-CPX-2ZE2DA...	I/O-module CPX-2ZE2DA	Connection technology and assembly, installation and commissioning instructions for counter modules of type CPX-2ZE2DA.
P.BE-CPX-AX...	CPX-EA modules, analogue	Connection technology and assembly, installation and commissioning instructions for analogue input and output modules of type CPX... as well as pressure sensors and proportional pressure regulators.
P.BE-CPX-CP...	CPX CP interface	Instructions on assembly, installation, commissioning and diagnostics of the CP interface.
P.BE-CPX-CTEL...	CPX CTEL interface	Instructions on assembly, installation, commissioning and diagnostics of the CPX CTEL master.
P.BE-CPX-CTEL-LK...	Electrical interface CPX-CTEL-2	Instructions on assembly, installation, commissioning and diagnostics for the CPX electrical interface for IO-Link.
CPX-CM-HPP...	CPX axis interface	Instructions on assembly, installation, commissioning and diagnostics of the CPX axis interface (CM-HPP).
P.BE-CPX-CMAX-SYS...	CPX axis controller	Instructions on assembly, installation, commissioning and diagnostics of the CPX axis controller (CMAX).
P.BE-CPX-CMAX-CONTROL...	CPX axis controller	Information on control, diagnostics and parameterisation of the axis controller via the fieldbus.
P.BE-CPX-CMPX-SYS...	CPX end-position controller	Instructions on assembly, installation, commissioning and diagnostics of the CPX end-position controller (CMPX).
P.BE-CPX-CMIX...	CPX measuring module	Instructions on assembly, installation, commissioning and diagnostics of the CPX measuring module (CMIX).
P.BE-CPX-FB... CPX...	CPX bus node	Instructions on assembly, installation, commissioning and diagnostics of the relevant bus node.
CPX-(M)-FB33_35/43_45...	CPX bus node for PROFINET	Instructions on assembly, installation, commissioning and diagnostics of the relevant bus node.
P.BE-CPX-CEC...	CPX CODESYS controller (control block)	Instructions on assembly, installation, commissioning and diagnostics of the relevant control block.

User documentation – GSD, EDS, ...

Device description files and icons are used to explain the integration of the CPX terminal in the configuration software of the various controller manufacturers.

These can be downloaded quickly and easily from www.festo.com.

Data sheet – CPX Maintenance Tool

Function

The CPX Maintenance Tool (CPX-FMT) combines service software with a connecting adapter. The service software is a tool for the design, parameterisation and online diagnostics of the CPX terminal.

The USB-to-M12 adapter features built-in galvanic isolation (between CPX and PC) and enables a PC to be connected to the diagnostic interface of the CPX terminal.

- Adapters
- Software on CD-ROM

**Application**

Only from Festo

The CPX-FMT software enables access to CPX valve terminals via Ethernet with the bus nodes EtherNet/IP (FB 36), Sercos III (FB 39) and PROFINET (FB 33, FB 34, FB 35, FB 41, FB 45). The bus nodes or control blocks can be connected directly to a PC via a USB adapter from Festo. Diagnostic data such as the error trace or module diagnostics can be read out and parameters can be modified in plain text.

The data can be used directly on a PC. There is an option, for example, to send screenshots of a configuration or the current error trace directly via e-mail. In addition, CPX configurations can also be saved and archived directly as a CPX-FMT project. Undocumented changes can subsequently be identified using the online/offline comparison function.

On-site tests such as the actuation of valves or the emulation of sensor feedback (in both cases called "forcing"), for example, can be carried out without an existing controller infrastructure.

It must be noted that with the CPX-FMT, only local parameters on the CPX valve terminal can be changed and saved. The configuration of the networks or controller software cannot be influenced.

General technical data		
Type		NEFC-M12G5-0.3-U1G5
System requirements	PC	IBM-compatible
	Drive	CD-ROM
	Interfaces	USB port (specification USB 1.1 or higher)
	Operating system	Microsoft Windows 2000 or XP
Function range		<ul style="list-style-type: none"> • Configuration and parameterisation • Reading out of system, module, channel diagnostics and error trace • Saving of the configuration as a project • Integration of plug-ins/links to self-executing programs
Scope of delivery		<ul style="list-style-type: none"> • Adapter, M12, 5-pin to mini USB socket • CD-ROM with installation program
Type of mounting		Screw-in
Electrical connection		Plug M12x1, 5-pin
Adapter cable composition		4 x 0.34 mm ²
Cable length	[m]	0.3
Degree of protection to EN 60529		IP20
CE marking (see declaration of conformity) ¹⁾		To EU RoHS Directive
UKCA marking (see declaration of conformity) ¹⁾		To UK RoHS instructions
Ambient temperature	[°C]	-5 ... +50
Material	Housing	ABS
	Cable sheath	PUR
	Pin contact	Gold-plated brass
Note on materials		RoHS-compliant
PWIS conformity		VDMA24364-B2-L

1) Additional information: www.festo.com/catalogue/... → Support/Downloads.

Data sheet – CPX Maintenance Tool

Dimensions

Download CAD data → www.festo.com

- [1] Mini B 5P USB port
- [2] Plug M12x1, 5-pin

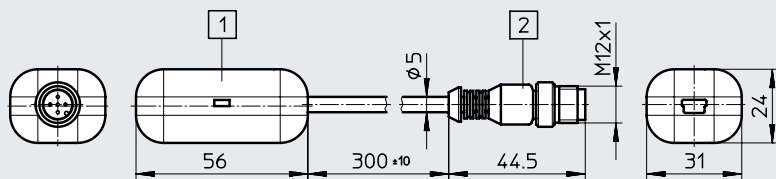

Ordering data

Designation	Part no.	Type
 CPX Maintenance Tool (CPX-FMT), software and USB-to-M12 adapter	547432	NEFC-M12G5-0.3-U1G5

Data sheet – CPX-IOT gateway

- Industrial Ethernet
- TCP/IP
- OPC UA
- Web interface

Gateway for continuous transfer of operating data from connected Festo components to a central storage location (MQTT broker).

Comprehensive status information for the gateway is displayed using 7 specific LEDs.

The gateway can only be used as a combination with end plates and an interlinking block; no additional CPX modules are possible.



Application

Data collection

The CPX-IOT gateway gathers information and transfers it to a central storage location (user-specific MQTT broker).

The transfer takes place using secure protocols. The customer can only connect to the internet via a firewall.

The extent of the data gathered and transferred is determined by the evaluation software (app).

Advantages:

- The central controller of the machine or system does not require an internet connection
- Operating data are available outside the system

Prerequisites

- Connected components must have corresponding evaluation software (app)
- Internet connection
- Components to be monitored have an Industrial Ethernet interface
- MQTT broker

Information that can be evaluated (depending on the software):

- (Energy) consumption monitoring
- Preventive maintenance
- Visualisation of overall equipment effectiveness
- Identification data
- Diagnostic data
- Parameter data
- Operating status data

Interfaces

Onward communication between the gateway and the central storage location (MQTT broker) is via an Industrial Ethernet interface with M12x1 plug, D-coded to IEC 947-5-2.

The operating mode of the gateway is set using a rotary switch. This enables simple interruption of this network connection on site.

Communication with the components being monitored is also via an Industrial Ethernet interface with M12x1 plug, D-coded to IEC 947-5-2.

Both connections have auto-negotiation and crossover detection as factory settings.

Data sheet – CPX-IOT gateway

Design

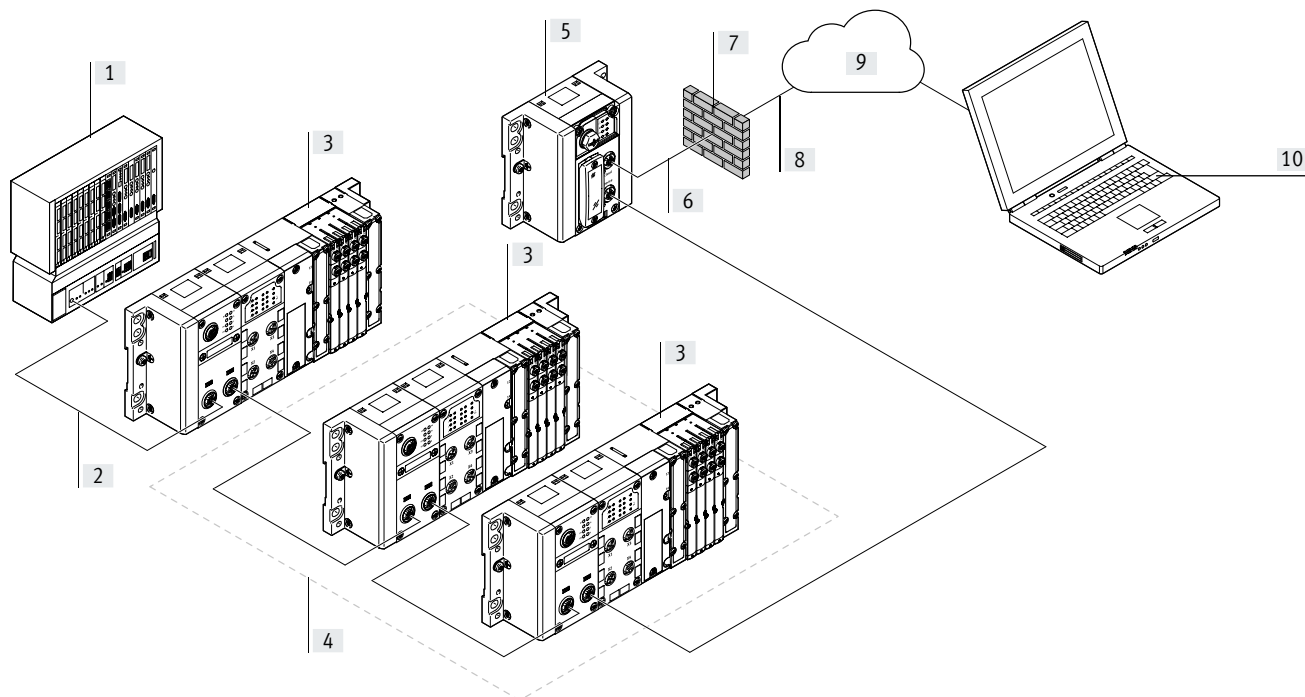

- | | | | |
|--|---|--|--|
| [1] PLC to machine/system controller (no direct internet connection) | [3] Festo components with bus connection with serial linking | [6] Internet connection | [9] Central storage location (user-specific MQTT broker) provided by Festo |
| [2] Bus system from the controller to the system parts (e.g. PROFINET) | [4] Components from which the CPX-IOT is collecting and transferring data | [7] Customer firewall or other security precautions | [10] Simple decentralised evaluation of data using adapted programs (apps) for the components that are being monitored |
| | [5] Gateway CPX-IOT | [8] Transferring data to a central storage location (MQTT broker) using secure protocols | |

Data sheet – CPX-IOT gateway

General technical data		
Type		CPX-IOT
Fieldbus interface	Protocol	Ethernet OPC UA
	Function	Bus connection to Ethernet-based Festo devices
	Connection type	Socket
	Connection technology	M12x1, D-coded to EN 61076-2-101
	Number of pins/wires	4
	Galvanic isolation	Yes
	Transmission rate	[Mbps] 100
Ethernet interface	Protocol	TCP/IP
	Function	Connection to MQTT broker
	Connection type	Socket
	Connection technology	M12x1, D-coded to EN 61076-2-101
	Number of pins/wires	4
	Transmission rate	[Mbps] 10 [Mbps] 100
CPU data		Dual core 533 MHz 256 MB RAM
Configuration support		Integrated web server
Diagnostics via LED		Modify
		Module location
		Network status
		Network status port 1
		Network status port 2
		Power supply, electronics/sensors
		Power supply load
		System error
Control elements		Rotary switch for setting operating mode
		DIL switch for resetting to delivery status
IP address setting		DHCP
		Static via web server
Technical data – Electrics		
Nominal operating voltage DC for electronics/sensors	[V DC]	24
Permissible voltage fluctuations for electronic system/sensors	[%]	±25
Power failure buffering	[ms]	10
Intrinsic current consumption at nominal operating voltage for electronic system/sensors	[mA]	Typically 80
Protection against direct and indirect contact		PELV
Technical data – Mechanical components		
Type of mounting		With H-rail
Product weight	[g]	130
Grid dimension	[mm]	50
Dimensions W x L x H	[mm]	50 x 107 x 50
Materials		
Housing		PA
Note on materials		RoHS-compliant
PWIS conformity		VDMA24364-B2-L

Data sheet – CPX-IOT gateway

Operating and environmental conditions		
Ambient temperature	[°C]	- 5... +50
Storage temperature	[°C]	- 20... +70
Relative humidity	[%]	95
		Non-condensing
Corrosion resistance class CRC ¹⁾		0
CE marking (see declaration of conformity) ³⁾		To EU EMC Directive ²⁾
Degree of protection		IP65
		IP67

1) Additional information: www.festo.com/x/topic/kbk

2) For information about the area of use, see the EC declaration of conformity at: www.festo.com/catalogue/... → Support/Downloads.

If the devices are subject to usage restrictions in residential, commercial or light-industrial environments, further measures for the reduction of the emitted interference may be necessary.

3) Additional information: www.festo.com/catalogue/... → Support/Downloads.

Safety characteristics	
Shock resistance	Shock test with severity level 1 to FN 942017-5 and EN 60068-2-27
Vibration resistance	Transport application test with severity level 1 to FN 942017-4 and EN 60068-2-6

Connection and display components

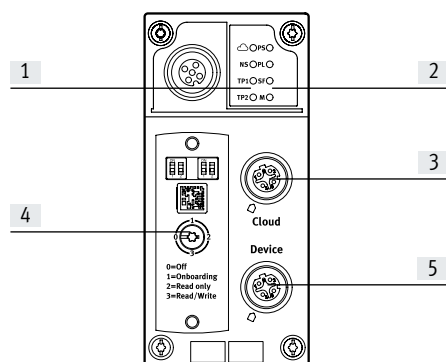

- [1] Network-specific LED displays
- [2] Gateway-specific LED displays
- [3] Connection to MQTT broker (M12x1 socket, 4-pin, D-coded)
- [4] Transparent switch cover
- [5] Bus connection to Ethernet-based Festo devices (M12x1 socket, 4-pin, D-coded)







Pin allocation for MQTT broker connection and bus connection to Ethernet-based Festo devices			
Terminal allocation	Pin	Signal	Designation
M12x1 socket, D-coded			
	1	TD+	Transmitted data+
	2	RD+	Received data+
	3	TD-	Transmitted data-
	4	RD-	Received data-
	Housing	Shielding	Connected to functional earth (FE) via RC link

Data sheet – CPX-IOT gateway

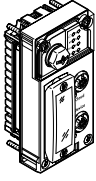
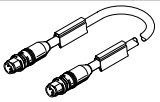

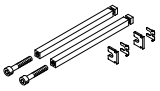
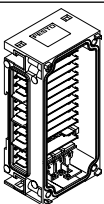
Combinations of interlinking blocks and gateway		
Interlinking blocks	Part no.	Gateway
		CPX-IOT
CPX-GE-EV-S	195746	■
CPX-GE-EV-S-VL	8022170	-
CPX-GE-EV-S-7/8-4POL	541248	-
CPX-GE-EV-S-7/8-5POL	541244	■
CPX-GE-EV-S-7/8-5POL-VL	8022172	-
CPX-M-GE-EV-S-7/8-CIP-4P	568956	-
CPX-M-GE-EV-S-7/8-5POL	550208	-
CPX-M-GE-EV-S-7/8-5POL-VL	8022165	-
CPX-M-GE-EV-S-PP-5POL	563057	-
CPX-GE-EV	195742	■
CPX-M-GE-EV	550206	-
CPX-M-GE-EV-FVO	567806	-
CPX-GE-EV-Z	195744	-
CPX-GE-EV-Z-VL	8022166	-
CPX-GE-EV-Z-7/8-4POL	541250	-
CPX-GE-EV-Z-7/8-5POL	541246	-
CPX-GE-EV-Z-7/8-5POL-VL	8022173	-
CPX-M-GE-EV-Z-7/8-5POL	550210	-
CPX-M-GE-EV-Z-7/8-5POL-VL	8022158	-
CPX-M-GE-EV-S-M12-5POL	8098392	-
CPX-M-GE-EV-Z-PP-5POL	563058	-
CPX-GE-EV-V	533577	-
CPX-GE-EV-V-VL	8022171	-
CPX-GE-EV-V-7/8-4POL	541252	-
CPX-M-GE-EV-W-M12-5POL	8098391	-

Combinations of end plates and gateway		
End plates	Part no.	Gateway
		CPX-IOT
CPX-EPL-EV	195716	■
CPX-EPL-EV-S	576315	■
CPX-EPL-EV-X	576314	-
CPX-EPR-EV	195714	■
CPX-EPR-EV-X	576313	-

Data sheet – CPX-IOT gateway

Ordering data		Part no.	Type	
Designation				
Gateway				
		8069773	CPX-IOT	
Bus connection				
	Connecting cable, straight plug, M12x1, 4-pin, D-coded	Straight plug, M12x1, 4-pin, D-coded	0.5 m	8040446 NEBC-D12G4-ES-0.5-S-D12G4-ET
			1 m	8040447 NEBC-D12G4-ES-1-S-D12G4-ET
			3 m	8040448 NEBC-D12G4-ES-3-S-D12G4-ET
			5 m	8040449 NEBC-D12G4-ES-5-S-D12G4-ET
			10 m	8040450 NEBC-D12G4-ES-10-S-D12G4-ET
		Straight plug, RJ45, 8-pin	1 m	8040451 NEBC-D12G4-ES-1-S-R3G4-ET
			3 m	8040452 NEBC-D12G4-ES-3-S-R3G4-ET
			5 m	8040453 NEBC-D12G4-ES-5-S-R3G4-ET
Open end, 4-wire	10 m	8040454 NEBC-D12G4-ES-10-S-R3G4-ET		
	5 m	8040456 NEBC-LE4-ES-5-D12G4-ET		
	Cover cap for sealing unused bus connections (10 pieces)	165592	ISK-M12	
Tie rod				
	Tie rod CPX	Tie rod CPX	1-module	195718 CPX-ZA-1
Interlinking block				
	Without power supply	–	195742 CPX-GE-EV	
	With system supply	M18	195746 CPX-GE-EV-S	
		7/8" – 5-pin	541244 CPX-GE-EV-S-7/8-5POL	
End plates				
	Left-hand end plate	Without supply	195716 CPX-EPL-EV	
		With system supply	576315 CPX-EPL-EV-S	
	Right-hand end plate	–	195714 CPX-EPR-EV	
		Earthing component for right-hand/left-hand end plate	5 pieces	538892 CPX-EPFE-EV

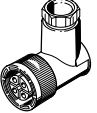
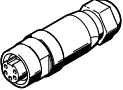
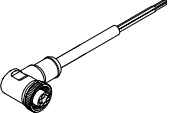
Data sheet – CPX-IOT gateway

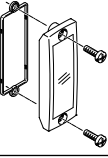
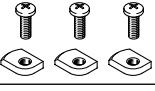
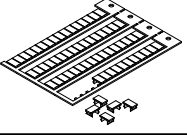
Ordering data				Part no.	Type
Designation					
Power supply					
	Plug socket for mains connection M18x1, 4-pin	Straight	For 1.5 mm ²	18493	NTSD-GD-9
			For 2.5 mm ²	18526	NTSD-GD-13.5
		Angled	For 1.5 mm ²	18527	NTSD-WD-9
			For 2.5 mm ²	533119	NTSD-WD-11
	Plug socket for mains connection 7/8", straight, 5-pin		0.25 ... 2.0 mm ²	543107	NECU-G78G5-C2
	Plug socket for mains connection 7/8", angled, 5-pin – open cable end, 5-wire		2 m	573855	NEBU-G78W5-K-2-N-LE5
	Straight plug, spring-loaded terminal, for left-hand end plate with system supply		7-pin	576319	NECU-L3G7-C1
Cover					
	Inspection cover, transparent			533334	AK-SUB-9/15-B
Mounting					
	Mounting for H-rail			526032	CPX-CPA-BG-NRH
Inscription labels					
	Inscription labels 6x10 mm, 64 pieces, in frame			18576	IBS-6x10

Data sheet – CODESYS controller

- Industrial Ethernet
- TCP/IP
- EasyIP
- Web interface
- Email
- Data transfer

The CODESYS controller is a modern control system for CPX terminals that enables programming with CODESYS to IEC 61131-3.

The power supply to and communication with other modules takes place via the interlinking block.

In addition to network connections, LEDs are also provided for the bus status, operating status of the PLC and CPX peripherals information, as are switching elements and a diagnostic interface for CPX-FMT.



Application

Bus connection

The CPX-CEC is a remote controller that can be connected to a higher-order PLC via the bus nodes of the CPX terminal or via Ethernet.

At the same time, it is possible to operate the CPX-CEC as a compact stand-alone controller directly on the machine.

Communication protocols

- Fieldbus via CPX bus nodes
- Modbus/TCP
- EasyIP

Operating modes

- Stand-alone
- Remote controller, fieldbus
- Remote controller, Ethernet

Setting options

The CPX-CEC has the following interfaces for monitoring, programming and commissioning:

- For the CPX-FMT
- Ethernet interface for IT applications
- Remote diagnostics

The operating mode and fieldbus protocol are set using the DIL switch on the CPX-CEC.

The integrated web server offers a convenient means of querying data saved in the CPX-CEC.

Features

- Easy control of valve terminal configurations with MPA, VTSA
- Diagnostics with flexible monitoring options for pressure, flow rate, cylinder operating time, air consumption

- Activation of decentralised installation systems on the basis of CPI control of applications in proportional pneumatics
- AS-Interface control via gateway

- Connection to all fieldbuses as a remote controller and for preprocessing
- Control of electric actuators as individual axes via CANopen (CPX-CEC-C1/-M1)

- Early warnings and visualisation options
- Servo-pneumatic applications

Data sheet – CODESYS controller

General technical data		
Protocol		CODESYS Level 2
		EasyIP
		Modbus TCP
		TCP/IP
Processing time		Approx. 200 µs/1 k instructions
Programming software		CODESYS provided by Festo
Programming language		To IEC 61131-3
		Sequential function chart (SFC)
		Instruction list (IL)
		Function chart (FCH), additional continuous function chart (CFC)
		Ladder diagram (LD)
Programming	Operating language	German, English
	Support for file handling	Yes
Device-specific diagnostics		Diagnostic memory
		Channel and module-oriented diagnostics
		Undervoltage/short-circuit modules
LED displays	Bus-specific	TP: Link/traffic
	Product-specific	RUN: PLC status
		STOP: PLC status
		ERR: PLC runtime error
		PS: Electronics supply, sensor supply
		PL: Load supply
		SF: System fault
M: Modify/forcing active		
IP address setting		DHCP
		Via CODESYS
		Via MMI
Function blocks		CPX diagnostic status, copy CPX diagnostic trace, read CPX module diagnostics, and more
Dimensions (including interlinking block) W x L x H	[mm]	50 x 107 x 55

Materials	
Housing	PA-reinforced
	PC
Note on materials	RoHS-compliant
PWIS conformity	VDMA24364-B2-L

Operating and environmental conditions		
Ambient temperature	[°C]	-5 ... +50
Storage temperature	[°C]	-20 ... +70
Relative humidity	[%]	95, non-condensing
Corrosion resistance class CRC ¹⁾		2

1) Additional information: www.festo.com/x/topic/kbk

Electrical data			
Nominal operating voltage		[V DC]	24
Load voltage	Nominal operating voltage	[V DC]	24
	With pneumatics type VTSA	[V DC]	21.6 ... 26.4
	With pneumatics type MPA	[V DC]	18 ... 30
	Without pneumatics	[V DC]	18 ... 30
Power failure buffering		[ms]	10
Intrinsic current consumption at nominal operating voltage		[mA]	Typically 85
Degree of protection to EN 60529			IP65, IP67

Data sheet – CODESYS controller

Technical data					
Type		CPX-CEC-C1	CPX-CEC-C1-V3	CPX-CEC-M1-V3	
Additional functions		Motion functions for electric drives		SoftMotion functions for electric drives	
CPU data	Flash	[MB]	32	32	32
	RAM	[MB]	32	256	256
	Processor	[MHz]	400	800	800
Control interface		CAN bus		CAN bus	
Parameterisation		CODESYS V2.3		CODESYS V3	
Configuration support		CODESYS V2.3		CODESYS V3	
Program memory, user program		[MB]	4	16	16
Flags		CODESYS variable concept			
	Remanent data	[kB]	30	28	28
	Global data memory	[MB]	8	–	–
Control elements		DIL switch for CAN termination			
		Rotary switch for RUN/STOP			
Total number of axes		31	127	31	
Ethernet	Number		1		
	Connection technology		RJ45 socket, 8-pin		
	Data transmission speed	[Mbps]	10/100		
	Supported protocols		TCP/IP, EasyIP, Modbus TCP		
Fieldbus interface	Number		1		
	Connection technology		Sub-D plug, 9-pin		
	Data transmission speed, can be set via software	[kbps]	125, 250, 500, 800, 1000	125, 250, 500, 800, 1000	125, 250, 500, 800, 1000
	Supported protocols		CAN bus		
	Galvanic isolation		Yes		

Technical data				
Type		CPX-CEC	CPX-CEC-S1-V3	
CPU data	Flash	[MB]	32	32
	RAM	[MB]	32	256
	Processor	[MHz]	400	800
Parameterisation		CODESYS V2.3		CODESYS V3
Configuration support		CODESYS V2.3		CODESYS V3
Additional functions		Diagnostic functions		
		RS232 communication function		
Program memory, user program		[MB]	4	16
Flags		CODESYS variable concept		CODESYS variable concept
	Remanent data	[kB]	30	28
	Global data memory	[MB]	8	–
Control elements		Rotary switch for RUN/STOP		
Ethernet	Number		1	
	Connection technology		RJ45 socket, 8-pin	
	Data transmission speed	[Mbps]	10/100	
	Supported protocols		TCP/IP, EasyIP, Modbus TCP	
Data interface	Number		1	
	Connection technology		Sub-D socket, 9-pin	
	Data transmission speed	[kbps]	9.6 ... 230.4	
	Supported protocols		RS232 interface	
	Max. cable length	[m]	–	30
Galvanic isolation		Yes		

Data sheet – CODESYS controller

Connection and display elements CPX-CEC-C1/-M1

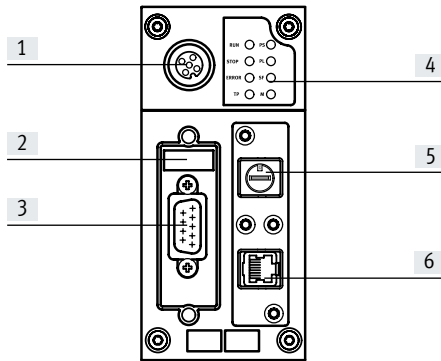

- [1] CPX-FMT connection
- [2] DIL switch
- [3] Fieldbus interface
(Sub-D plug, 9-pin)
- [4] Status LEDs, bus-specific and
product-specific
- [5] RUN/STOP rotary switch
- [6] Ethernet interface (RJ45 socket,
8-pin)

Pin allocation – CPX-CEC-C1/-M1

	Pin	Signal	Meaning
Fieldbus interface, Sub-D plug			
	1	n.c.	Not connected
	2	CAN_L	CAN low
	3	CAN_GND	CAN ground
	4	n.c.	Not connected
	5	CAN_SHLD	Connection to functional earth FE
	6	CAN_GND	CAN ground (optional) ¹⁾
	7	CAN_H	CAN high
	8	n.c.	Not connected
	9	n.c.	Not connected
Housing	Shielding	Plug housing must be connected to FE	
Ethernet interface, RJ45 plug			
	1	TD+	Transmitted data+
	2	TD-	Transmitted data-
	3	RD+	Received data+
	4	n.c.	Not connected
	5	n.c.	Not connected
	6	RD-	Received data-
	7	n.c.	Not connected
	8	n.c.	Not connected
Housing	Shielding	Shielding	

1) If a servo drive is connected to an external power supply, CAN ground (optional), pin 6, cannot be used on the CPX-CEC-C1/-M1.

Data sheet – CODESYS controller

Connection and display elements CPX-CEC/CPX-CEC-S1-V3

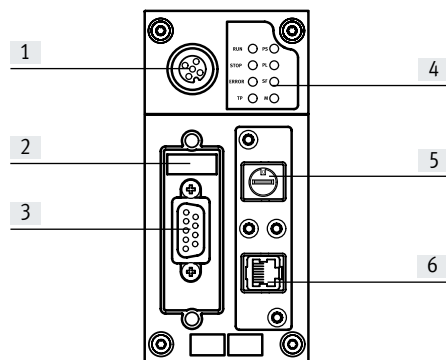







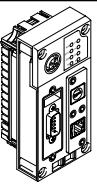
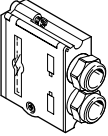

- [1] CPX-FMT connection
- [2] DIL switch
- [3] RS232 interface
(Sub-D socket, 9-pin)
- [4] Status LEDs, bus-specific and
product-specific
- [5] RUN/STOP rotary switch
- [6] Ethernet interface (RJ45 socket,
8-pin)

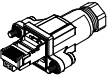

Pin allocation – CPX-CEC/CPX-CEC-S1-V3

	Pin	Signal	Meaning
RS 232 interface, Sub-D socket			
	1	n.c.	Not connected
	2	RxD	Received data
	3	TxD	Transmitted data
	4	n.c.	Not connected
	5	GND	Data reference potential
	6	n.c.	Not connected
	7	n.c.	Not connected
	8	n.c.	Not connected
	9	n.c.	Not connected
	Shielding	Shielding	Connection to functional earth
Ethernet interface, RJ45 plug			
	1	TD+	Transmitted data+
	2	TD-	Transmitted data-
	3	RD+	Received data+
	4	n.c.	Not connected
	5	n.c.	Not connected
	6	RD-	Received data-
	7	n.c.	Not connected
	8	n.c.	Not connected
	Housing	Shielding	Shielding

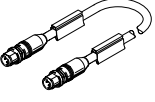
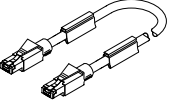
Data sheet – CODESYS controller

Ordering data					Part no.	Type
Designation						
Control block						
	Motion functions for electric drives		CODESYS V2.3	155 g	567347	CPX-CEC-C1
			CODESYS V3	135 g	3473128	CPX-CEC-C1-V3
	SoftMotion functions for electric drives		CODESYS V3	135 g	3472765	CPX-CEC-M1-V3
	RS232 communication function		CODESYS V2.3	155 g	567346	CPX-CEC
			CODESYS V3	135 g	3472425	CPX-CEC-S1-V3
Fieldbus interface						
	Sub-D plug, 9-pin, for CANopen				532219	FBS-SUB-9-BU-2x5POL-B
	Micro style bus connection, 2xM12 for DeviceNet/CANopen				525632	FBA-2-M12-5POL
	Socket for micro style connection, M12				18324	FBSD-GD-9-5POL
	Plug for micro style connection, M12				175380	FBS-M12-5GS-PG9
	Open style bus connection for 5-pin terminal strip for DeviceNet/CANopen				525634	FBA-1-SL-5POL
	Terminal strip for open style connection, 5-pin				525635	FBSD-KL-2x5POL
Ethernet interface						
	RJ45 plug		Degree of protection IP 65, IP67		534494	FBS-RJ45-8-GS
	Cover for RJ45 connection		Degree of protection IP 65, IP67		534496	AK-RJ45
	Straight plug, RJ45, 8-pin	Straight plug, M12x1, 4-pin, D-coded	Degree of protection IP20	1 m	8040451	NEBC-D12G4-ES-1-S-R3G4-ET
				3 m	8040452	NEBC-D12G4-ES-3-S-R3G4-ET
				5 m	8040453	NEBC-D12G4-ES-5-S-R3G4-ET
				10 m	8040454	NEBC-D12G4-ES-10-S-R3G4-ET
	Straight plug, RJ45, 8-pin	Straight plug, RJ45, 8-pin	Degree of protection IP20	1 m	8040455	NEBC-R3G4-ES-1-S-R3G4-ET

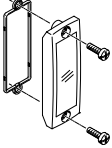
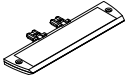
Data sheet – CODESYS controller

Ordering data		Part no.	Type
Designation			
Covers and attachments			
	Inspection cover, transparent, for Sub-D connection	533334	AK-SUB-9/15-B
	Inscription label holder for connection block	536593	CPX-ST-1
User documentation			
	Manual for control block CPX-CEC	German	569121 P.BE-CPX-CEC-DE
		English	569122 P.BE-CPX-CEC-EN

Data sheet – DeviceNet bus node



Bus node for handling communication between the electrical terminal CPX and a DeviceNet network.

The bus node is provided with system supply via the interlinking block and processes communication with the I/O modules.

The status of the CPX terminal is displayed as a common message via 4 CPX-specific LEDs.

The fieldbus communication status is displayed via the three DeviceNet-specific LEDs.

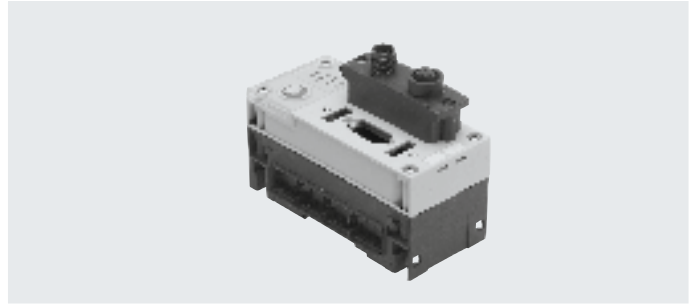

Application

Bus connection

The bus connection can be selected when ordering, either micro style as 2xM12 round plugs or open style as a terminal strip with IP20 protection.

Both connection types have the function of an integrated T-distributor with incoming and outgoing bus line.

DeviceNet implementation

The CPX-FB11 operates with the Predefined Master/Slave Connection Set as a Group 2 Only Server.

The polled I/O, change of state or cyclic method is used for the transmission of cyclic I/O data. The type of transmission can be selected in the network configuration.

The device diagnostics for all bus nodes CPX-FB11 is effectively gathered via strobed I/O and displayed in the input table of the controller.

In addition to cyclic data transmission, acyclic communication is supported through explicit messaging, which enables detailed device diagnostics and parameterisation.

A comprehensive EDS file supports the display of acyclic data. It is also possible to display system information and assign parameters while the controller is running via the user program or the configuration software.

An example of this is access to the integrated diagnostic memory function, i.e. storage of the last 40 errors with timestamp, module, channel and error type.

With its address capacity of 64 byte inputs and 64 byte outputs, the CPX-FB11 supports any configuration of I/O modules, including pneumatic interface.

Points to note in connection with CPX-CEC

When a bus node is combined with a control block (CPX-CEC, in the fieldbus remote controller operating mode), the connected I/Os and/or valves, sensors and actuators are controlled via the CPX control block.

In this case, the bus node only provides the communication interface to the PLC.

Communication between the control block and CPX bus node takes place by interlinking the CPX modules and takes

up the following address capacity in the CPX system:

- 8 byte outputs
- 8 byte inputs

The following address capacity remains in the control block or CPX system for activating the peripherals:

- 56 byte inputs
- 56 byte outputs

Data sheet – DeviceNet bus node

General technical data			
Type	CPX-FB11		
Fieldbus interface	Either <ul style="list-style-type: none"> • Micro style bus connection: 2xM12 with degree of protection IP65, IP67 • Open style bus connection: 5-pin terminal strip, IP20 		
Baud rate	[kbps]	125, 250, 500	
Addressing range	0 ... 63 Set using DIL switch		
Product	Type	Communication adapter (12 dec.)	
	Code	4554 dec.	
Types of communication	Polled I/O, change of state/cyclic, strobed I/O and explicit messaging		
Configuration support	EDS file and bitmaps		
Max. address capacity	Inputs	[byte]	64
	Outputs	[byte]	64
LED displays (bus-specific)	MS = Module status NS = Network status IO = I/O status		
Device-specific diagnostics	Module and channel-oriented diagnostics via manufacturer-specific diagnostic object		
Parameterisation	<ul style="list-style-type: none"> • Module and system parameterisation via configuration interface in plain text (EDS) • Online in run or program mode 		
Additional functions	<ul style="list-style-type: none"> • Storage of the last 40 errors with timestamp (access via EDS) • 8-bit system status in image table for inputs • 2-byte inputs and 2-byte outputs, system diagnostics in process image 		
Control elements	DIL switch		
Operating voltage	Nominal value	[V DC]	24
	Permissible range	[V DC]	18 ... 30
	Power failure buffering	[ms]	10
Current consumption	[mA]	Typically 200	
Degree of protection to EN 60529	IP65, IP67		
Temperature range	Operation	[°C]	-5 ... +50
	Storage/transport	[°C]	-20 ... +70
Materials	Reinforced PA, PC		
PWIS conformity	VDMA24364-B2-L		
Grid dimension	[mm]	50	
Dimensions (including interlinking block) W x L x H	[mm]	50 x 107 x 50	
Product weight	[g]	120	

**Note**

Please observe the general limits and guidelines for the system when configuring the electrical modules.

Data sheet – DeviceNet bus node

Connection and display components

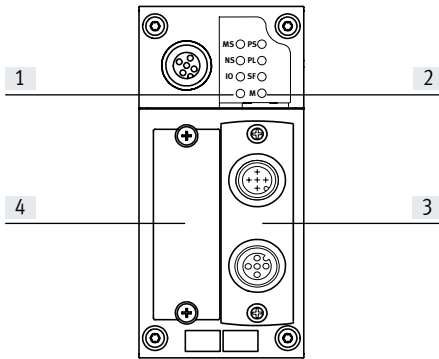







- [1] Bus-specific LEDs
- [2] CPX-specific status LEDs
- [3] Selectable fieldbus interface
 - Micro style
 - Open style
- [4] DIL switch cover

Pin allocation for the DeviceNet interface

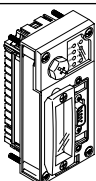
Terminal allocation	Pin	Signal-specific wire colour ¹⁾	Signal	Designation
Sub-D plug				
	1	–	n.c.	Not connected
	2	Blue	CAN_L	Received/transmitted data low
	3	Black	0 V bus	0 V CAN interface
	4	–	n.c.	Not connected
	5	Bare	Shielding	Connection to housing
	6	–	n.c.	Not connected
	7	White	CAN_H	Received/transmitted data high
	8	–	n.c.	Not connected
	9	Red	24 V DC bus	24 V DC supply CAN interface
Micro style bus connection (M12), incoming/outgoing				
Incoming				
	1	Bare	Shielding	Connection to housing
	2	Red	24 V DC bus	24 V DC supply CAN interface
	3	Black	0 V bus	0 V CAN interface
	4	White	CAN_H	Received/transmitted data high
	5	Blue	CAN_L	Received/transmitted data low
Outgoing				
	1	Bare	Shielding	Connection to housing
	2	Red	24 V DC bus	24 V DC supply CAN interface
	3	Black	0 V bus	0 V CAN interface
	4	White	CAN_H	Received/transmitted data high
	5	Blue	CAN_L	Received/transmitted data low
Open style bus connection				
	1	Black	0 V bus	0 V CAN interface
	2	Blue	CAN_L	Received/transmitted data low
	3	Bare	Shielding	Connection to housing
	4	White	CAN_H	Received/transmitted data high
	5	Red	24 V DC bus	24 V DC supply CAN interface
7/8" bus connection				
	1	Black	Shielding	Connection to housing
	2	Blue	24 V DC	24 V DC supply CAN interface
	3	Bare	0 V	0 V CAN interface
	4	White	CAN_H	Received/transmitted data high
	5	Red	CAN_L	Received/transmitted data low

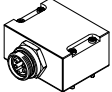
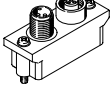
1) Typical of DeviceNet connecting cables

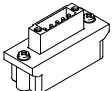
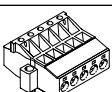
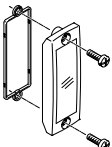
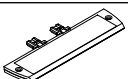
Data sheet – DeviceNet bus node

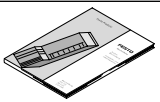
Ordering data		Part no.	Type	
Designation				
Bus node				
	DeviceNet bus node	526172	CPX-FB11	
Bus connection				
	Sub-D plug	532219	FBS-SUB-9-BU-2x5POL-B	
	Connection block, 9-pin Sub-D socket, 5-pin 7/8" plug	571052	CPX-AB-1-7/8-DN	
	Micro style bus connection, 2xM12	525632	FBA-2-M12-5POL	
	Socket for micro style connection, M12	18324	FBSD-GD-9-5POL	
	Plug for micro style connection, M12	175380	FBS-M12-5GS-PG9	
	Open style bus connection for 5-pin terminal strip	525634	FBA-1-SL-5POL	
	Terminal strip for open style connection, 5-pin	525635	FBSD-KL-2x5POL	
	Inspection cover, transparent	533334	AK-SUB-9/15-B	
	Inscription label holder for connection block	536593	CPX-ST-1	
	5-pin M12 to mini USB socket adapter and controller software	547432	NEFC-M12G5-0.3-U1G5	
User documentation				
	User documentation for bus node CPX-FB11	German	526421	P.BE-CPX-FB11-DE
		English	526422	P.BE-CPX-FB11-EN
		Spanish	526423	P.BE-CPX-FB11-ES
		French	526424	P.BE-CPX-FB11-FR
		Italian	526425	P.BE-CPX-FB11-IT

Data sheet – PROFIBUS bus node



Bus node for handling communication between the electrical terminal CPX and a higher-order master via PROFIBUS DP.

The bus node is provided with system supply via the interlinking block and processes communication with the I/O modules.

The status of the CPX terminal is displayed as a common message via 4 CPX-specific LEDs.

The fieldbus communication status is displayed via the PROFIBUS-specific error LED.



Application

Bus connection

The bus connection is established via a 9-pin Sub-D socket with a typical PROFIBUS allocation (to EN 50170).

The bus connector plug (with degree of protection IP65/IP67 from Festo or degree of protection IP20 from other manufacturers) facilitates the connection of an incoming and an outgoing bus cable.

An active bus terminal can be connected using the DIL switch integrated in the plug.

The Sub-D interface is designed for controlling network components with a fibre-optic cable connection.

PROFIBUS DP implementation

The CPX-FB13 supports the PROFIBUS DP protocol to EN 50170 Volume 2 for cyclic I/O exchange, parameterisation and diagnostic functions (DPV0).

In addition to DPV0, acyclic communication to the advanced specification DPV1 is supported. DPV1 provides acyclic access to advanced system information and allows parameterisation while the controller is running via the user program.

An example of this is access to the integrated diagnostic memory function, i.e. storage of the last 40 errors with timestamp, module, channel and error type.

With its address capacity of 64 byte inputs and 64 byte outputs, the CPX-FB13 supports any configuration of I/O modules, including pneumatic interface.

Points to note in connection with CPX-CEC

When a bus node is combined with a control block (CPX-CEC, in the fieldbus remote controller operating mode), the connected I/Os and/or valves, sensors and actuators are controlled via the CPX control block.

In this case, the bus node only provides the communication interface to the PLC.

Communication between the control block and CPX bus node takes place by interlinking the CPX modules and takes up the following address capacity in the CPX system:

- 8 byte outputs
 - 8 byte inputs
- The following address capacity remains in the control block or CPX system for activating the peripherals:
- 56 byte inputs
 - 56 byte outputs

Data sheet – PROFIBUS bus node

General technical data			
Type	CPX-FB13		
Fieldbus interface	Sub-D socket, 9-pin (EN 50170) Galvanically isolated 5 V		
Baud rate	[Mbps]	0.0096 ... 12	
Addressing range	1 ... 125 Set using DIL switch		
Product family	4: Valves		
ID number	0x059E		
Types of communication	DPV0: Cyclic communication DPV1: Acyclic communication		
Configuration support	GSD file and bitmaps		
Max. address capacity	Inputs	[byte]	64
	Outputs	[byte]	64
LED displays (bus-specific)	BF: Bus fault		
Device-specific diagnostics	Identifier and channel-oriented diagnostics to EN 50170 (PROFIBUS standard)		
Parameterisation	<ul style="list-style-type: none"> Start-up parameterisation via configuration interface in plain text (GSD) Acyclic parameterisation via DPV1 		
Additional functions	<ul style="list-style-type: none"> Storage of the last 40 errors with timestamp (access via DPV1) 8-bit system status in image table for inputs 2-byte inputs and 2-byte outputs, system diagnostics in process image 		
Control elements	DIL switch		
Operating voltage	Nominal value	[V DC]	24
	Permissible range	[V DC]	18 ... 30
	Power failure buffering	[ms]	10
Current consumption			[mA]
			Typically 200
Degree of protection to EN 60529	IP65, IP67		
Temperature range	Operation	[°C]	-5 ... +50
	Storage/transport	[°C]	-20 ... +70
Materials	Reinforced PA, PC		
PWIS conformity	VDMA24364-B2-L		
Grid dimension			[mm]
			50
Dimensions (including interlinking block) W x L x H			[mm]
			50 x 107 x 50
Product weight			[g]
			115

 **Note**

Please observe the general limits and guidelines for the system when configuring the electrical modules.

Data sheet – PROFIBUS bus node

Connection and display components

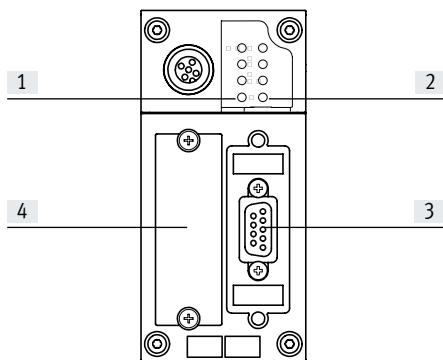



- [1] Bus status LEDs/bus fault
- [2] CPX-specific status LEDs
- [3] Fieldbus interface (Sub-D socket, 9-pin)
- [4] DIL switch cover

Pin allocation for PROFIBUS DP interface

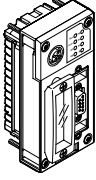
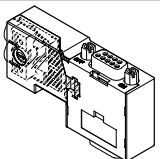
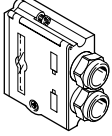
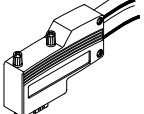
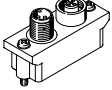
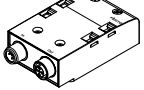

Terminal allocation	Pin	Signal	Designation
Sub-D socket			
	1	n.c.	Not connected
	2	n.c.	Not connected
	3	RxD/TxD-P	Received/transmitted data P
	4	CNTR-P ¹⁾	Repeater control signal
	5	DGND	Data reference potential (M5V)
	6	VP	Supply voltage (P5V)
	7	n.c.	Not connected
	8	RxD/TxD-N	Received/transmitted data N
	9	n.c.	Not connected
Housing	Shielding	Connection to housing	
Bus connection M12 adapter (B-coded)			
Incoming			
	1	n.c.	Not connected
	2	RxD/TxD-N	Received/transmitted data N
	3	n.c.	Not connected
	4	RxD/TxD-P	Received/transmitted data P
	5 and M12	Shielding	Connection to FE (functional earth)
Outgoing			
	1	VP	Supply voltage (P5V)
	2	RxD/TxD-N	Received/transmitted data N
	3	DGND	Data reference potential (M5V)
	4	RxD/TxD-P	Received/transmitted data P
	5 and M12	Shielding	Connection to FE (functional earth)

1) The repeater control signal CNTR-P is realised as a TTL signal.

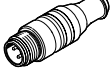
Data sheet – PROFIBUS bus node

Ordering data		Part no.	Type
Designation			
Bus node			
	PROFIBUS bus node	195740	CPX-FB13
Bus connection			
	Sub-D plug, straight, with terminating resistor and programming interface	574589	NECU-S1W9-C2-APB
	Sub-D plug, straight	532216	FBS-SUB-9-GS-DP-B
	Sub-D plug, angled	533780	FBS-SUB-9-WS-PB-K
	Bus connection M12 adapter (B-coded)	533118	FBA-2-M12-5POL-RK
	Connection block M12 adapter (B-coded)	541519	CPX-AB-2-M12-RK-DP
	5-pin M12x1 straight socket, for self-assembly of a connecting cable compatible with FBA-2-M12-5POL-RK and CPX-AB-2-M12-RK-DP	1067905	NECU-M-B12G5-C2-PB
	Plug M12x1, 5-pin, straight, for self-assembly of a connecting cable compatible with FBA-2-M12-5POL-RK and CPX-AB-2-M12-RK-DP	1066354	NECU-M-S-B12G5-C2-PB
	Terminating resistor, M12, B-coded for PROFIBUS	1072128	CACR-S-B12G5-220-PB

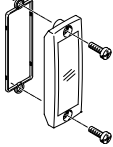
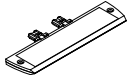
Data sheet – PROFIBUS bus node

Ordering data		Part no.	Type	
Designation				
Bus connection				
	Inspection cover, transparent	533334	AK-SUB-9/15-B	
	Inscription label holder for connection block M12	536593	CPX-ST-1	
	5-pin M12 to mini USB socket adapter and controller software	547432	NEFC-M12G5-0.3-U1G5	
User documentation				
	User documentation for bus node CPX-FB13	German	526427	P.BE-CPX-FB13-DE
		English	526428	P.BE-CPX-FB13-EN
		Spanish	526429	P.BE-CPX-FB13-ES
		French	526430	P.BE-CPX-FB13-FR
		Italian	526431	P.BE-CPX-FB13-IT

Data sheet – CANopen bus node



Bus node for handling communication between the electrical terminal CPX and a CANopen network master or CANopen network.

The bus node is provided with system supply via the interlinking block and processes communication with the I/O modules.

The status of the CPX terminal is displayed as a common message via 4 CPX-specific LEDs.

The different CANopen statuses and the fieldbus communication status are visualised via 3 additional LEDs.

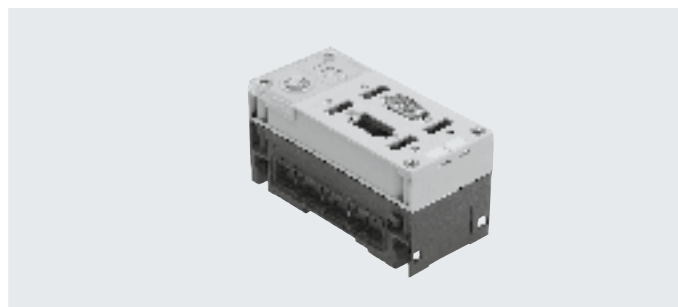

Application

Bus connection

The bus connection is established via a 9-pin Sub-D plug (pin) as per the CAN in Automation (CiA) specification DS 102 with additional 24 V CAN transceiver supply (option as per DS 102).

The bus connector plug (with degree of protection IP65/IP67 from Festo or degree of protection IP20 from other manufacturers) facilitates the connection of an incoming and an outgoing bus cable.

There are 4 contacts available for the 4 wires (CAN_L, CAN_H, 24 V, 0 V) of the incoming and outgoing bus cables respectively.

CANopen implementation

The CPX-FB14 supports the CANopen protocol in accordance with the specifications DS 301 V4.01 and DS 401 V2.0.

Implementation is based on the CiA Predefined Connection Set.

There are 4 PDOs available for fast I/O data exchange.

Enhanced system information can also be accessed via SDO communication. SDO communication also facilitates parameterisation before network start-up or while the controller is running via the user program.

An example of this is access to the integrated diagnostic memory function, i.e. storage of the last 40 errors with timestamp, module, channel and error type.

With its address capacity, the CPX-FB14 supports a large number of I/O module configurations, including pneumatic interface.

By default, 8 byte digital inputs and 8 byte digital outputs can be addressed via PDO 1.

8 analogue input channels and 8 analogue output channels can be addressed via PDO 2 and 3. Status and diagnostic information can be evaluated via PDO 4.

Additional 8 byte digital inputs and outputs as well as 8 analogue input and output channels can be addressed via mapping.

Points to note in connection with CPX-CEC

When a bus node is combined with a control block (CPX-CEC, in the fieldbus remote controller operating mode), the connected I/Os and/or valves, sensors and actuators are controlled via the CPX control block.

In this case, the bus node only provides the communication interface to the PLC.

Communication between the control block and CPX bus node takes place by interlinking the CPX modules and takes

up the following address capacity in the CPX system:

- 8 byte outputs
- 8 byte inputs

The following address capacity remains in the control block or CPX system for activating the peripherals:

- 56 byte inputs
- 56 byte outputs

Data sheet – CANopen bus node

General technical data			
Type	CPX-FB14		
Fieldbus interface	Sub-D plug, 9-pin (to DS 102) Bus interface galvanically isolated via optocoupler 24 V supply for CAN interface via bus		
Baud rate	[kbps]	125, 250, 500 and 1000 can be set via DIL switch	
Addressing range	Node ID 1 ... 127 Set using DIL switch		
Product family	Digital inputs and outputs		
Communication profile	DS 301, V4.01		
Device profile	DS 401, V2.0		
Number	PDO	4 Tx/4 Rx	
	SDO	1 server SDO	
Configuration support	EDS file and bitmaps		
Max. address capacity	Inputs	[byte]	16 digital, 16 analogue channels
	Outputs	[byte]	16 digital, 16 analogue channels
LED displays (bus-specific)	MS = Module status NS = Network status IO = I/O status		
Device-specific diagnostics	Via emergency message Object 1001, 1002 and 1003		
Parameterisation	Via SDO		
Additional functions	<ul style="list-style-type: none"> • Storage of the last 40 errors with timestamp (access via SDO) • 8-bit system status via transmit PDO 4 (default) • 2-byte inputs and 2-byte outputs, system diagnostics via PDO 4 • Minimum boot-up • Variable PDO mapping • Emergency message • Node guarding • Heart beat 		
Control elements	DIL switch		
Operating voltage	Nominal value	[V DC]	24
	Permissible range	[V DC]	18 ... 30
	Power failure buffering	[ms]	10
Current consumption			[mA] Typically 200
Degree of protection to EN 60529	IP65, IP67		
Temperature range	Operation	[°C]	-5 ... +50
	Storage/transport	[°C]	-20 ... +70
Materials	Reinforced PA, PC		
PWIS conformity	VDMA24364-B2-L		
Grid dimension			[mm] 50
Dimensions (including interlinking block) W x L x H			[mm] 50 x 107 x 50
Product weight			[g] 115

 **Note**

Please observe the general limits and guidelines for the system when configuring the electrical modules.

Data sheet – CANopen bus node

Connection and display components

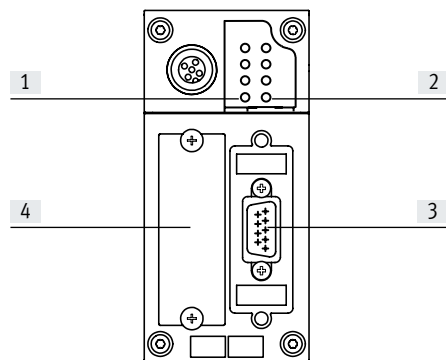



- [1] Bus-specific LEDs
- [2] CPX-specific status LEDs
- [3] Fieldbus interface (Sub-D plug, 9-pin)
- [4] DIL switch cover

Pin allocation of the CANopen interface

Terminal allocation	Pin	Signal	Designation
Sub-D plug			
	1	n.c.	Not connected
	2	CAN_L	Received/transmitted data low
	3	CAN_GND	0 V CAN interface
	4	n.c.	Not connected
	5	CAN_SHLD	Optional shielded connection
	6	GND	Ground ¹⁾
	7	CAN_H	Received/transmitted data high
	8	n.c.	Not connected
	9	CAN_V+	24 V DC supply CAN interface
Housing	Shielding	Connection to FE (functional earth)	
Micro style bus connection (M12)			
Incoming			
	1	Shielding	Connection to FE (functional earth)
	2	CAN_V+	24 V DC supply CAN interface
	3	CAN_GND	0 V CAN interface
	4	CAN_H	Received/transmitted data high
Outgoing	1	Shielding	Connection to FE (functional earth)
	2	CAN_V+	24 V DC supply CAN interface
	3	CAN_GND	0 V CAN interface
	4	CAN_H	Received/transmitted data high
	5	CAN_L	Received/transmitted data low
Open style bus connection			
	1	CAN_GND	0 V CAN interface
	2	CAN_L	Received/transmitted data low
	3	Shielding	Connection to FE (functional earth)
	4	CAN_H	Received/transmitted data high
	5	CAN_V+	24 V DC supply CAN interface

1) Connected internally via Pin 3

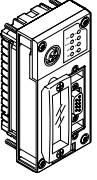
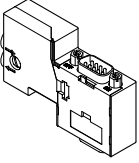
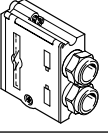
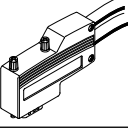
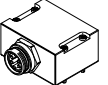
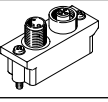
Data sheet – CANopen bus node

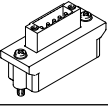
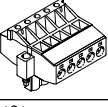
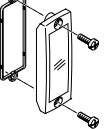
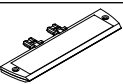
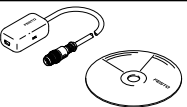
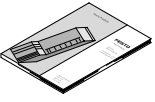
Ordering data		Part no.	Type	
Designation				
Bus node				
	CANopen bus node	526174	CPX-FB14	
Bus connection				
	Sub-D socket for CANopen with terminating resistor and programming interface	574588	NECU-S1W9-C2-ACO	
	Sub-D socket	532219	FBS-SUB-9-BU-2x5POL-B	
	Sub-D socket, angled	533783	FBS-SUB-9-WS-CO-K	
	Connection block, 9-pin Sub-D socket, 5-pin 7/8" plug	571052	CPX-AB-1-7/8-DN	
	Micro style bus connection, 2xM12, 5-pin	525632	FBA-2-M12-5POL	
	Fieldbus socket for micro style connection, M12, 5-pin	18324	FBSD-GD-9-5POL	
	Plug for micro style connection, M12, 5-pin	175380	FBS-M12-5GS-PG9	
	Open style bus connection	525634	FBA-1-SL-5POL	
	Terminal strip for open style connection, 5-pin	525635	FBSD-KL-2x5POL	
	Inspection cover, transparent	533334	AK-SUB-9/15-B	
	Inscription label holder for connection block	536593	CPX-ST-1	
	5-pin M12 to mini USB socket adapter and controller software	547432	NEFC-M12G5-0.3-U1G5	
User documentation				
	User documentation for bus node CPX-FB14	German	526409	P.BE-CPX-FB14-DE
		English	526410	P.BE-CPX-FB14-EN
		Spanish	526411	P.BE-CPX-FB14-ES
		French	526412	P.BE-CPX-FB14-FR
		Italian	526413	P.BE-CPX-FB14-IT

Data sheet – CC-Link bus node

CC-Link

Bus node for handling communication between the electrical terminal CPX and a higher-order master for Control & Communication-Link (CC-Link) from Mitsubishi.

The bus node is provided with system supply via the interlinking block and processes communication with the I/O modules.

The status of the CPX terminal is displayed as a common message via 4 CPX-specific LEDs.

The fieldbus communication status is displayed via 4 CC-Link-specific LEDs.



Application

Bus connection

The bus connection can be selected when ordering and is established via a screw terminal with degree of protection IP20, a Sub-D plug with degree of

protection IP65/IP67 from Festo or degree of protection IP20 from other manufacturers.

Both connection types have the function of an integrated T-distributor and thus support the connection of an incoming and outgoing bus cable.

CC-Link implementation

The CPX bus node CPX-FB23-24 optionally supports the CC-Link versions 2.0 (as function module F24) and 1.1 (as function module F23).

These designations are also found in the system diagram for the CPX Maintenance Tool (CPX-FMT) from Festo.

Function module F24 corresponds to CC-Link version 2.0 and supports a maximum of four stations per slave, up to an address capacity of 64 bytes of digital I/O and 64 bytes of analogue I/O in each case.

It is possible to optimise the configuration of the addressing in terms of either cycle time or station.

Function module F23 corresponds to CC-Link version 1.1 and supports a maximum of four stations per slave, up to an address capacity of 32 bytes of digital I/O and 14 bytes of analogue I/O in each case.

The function module and option are set using the DIL switch on the CPX bus node.

Points to note in connection with CPX-CEC

When a bus node is combined with a control block (CPX-CEC, in the fieldbus remote controller operating mode), the connected I/Os and/or valves, sensors and actuators are controlled via the CPX control block.

In this case, the bus node only provides the communication interface to the PLC.

Communication between the control block and CPX bus node takes place by interlinking the CPX modules and takes

up the following address capacity in the CPX system:

- 8 byte outputs
- 8 byte inputs

The following address capacity remains in the control block or CPX system for activating the peripherals:

- 56 byte inputs
- 56 byte outputs

Data sheet – CC-Link bus node

General technical data				
Type	CPX-FB23-24			
Fieldbus interface	Either <ul style="list-style-type: none"> • Sub-D socket, 9-pin • Sub-D plug, for self-assembly • Screw terminal strip, IP20 			
Baud rate	[kbps]	156 ... 10000		
Protocol	CC-Link			
Max. address capacity, inputs	FB23	RWr	[byte]	32
		Rx	[byte]	14
	FB24	RWr	[byte]	64
		Rx	[byte]	64
Max. address volume for outputs	FB23	RWw	[byte]	32
		Ry	[byte]	14
	FB24	RWw	[byte]	64
		Ry	[byte]	64
LED displays (bus-specific)	RUN = Communication status ERROR = Communication error SD = Send data RD = Receive data			
Device-specific diagnostics	<ul style="list-style-type: none"> • Diagnostic memory • Channel and module-oriented diagnostics • Undervoltage of modules 			
Parameterisation	<ul style="list-style-type: none"> • Diagnostic behaviour • Fail-safe response • Forcing of channels • Signal setup • System parameters 			
Additional functions	<ul style="list-style-type: none"> • System status can be displayed using process data • Additional diagnostic interface for operator units 			
Control elements	DIL switch			
Operating voltage	Nominal value	[V DC]	24	
	Permissible range	[V DC]	18 ... 30	
Current consumption		[mA]	Typically 200	
Degree of protection to EN 60529	IP65, IP67			
Temperature range	Operation	[°C]	-5 ... +50	
	Storage/transport	[°C]	-20 ... +70	
Materials	Reinforced PA, PC			
PWIS conformity	VDMA24364-B2-L			
Grid dimension		[mm]	50	
Dimensions (including interlinking block) W x L x H		[mm]	50 x 107 x 50	
Product weight		[g]	115	

 **Note**

Please observe the general limits and guidelines for the system when configuring the electrical modules.

Data sheet – CC-Link bus node

Connection and display components

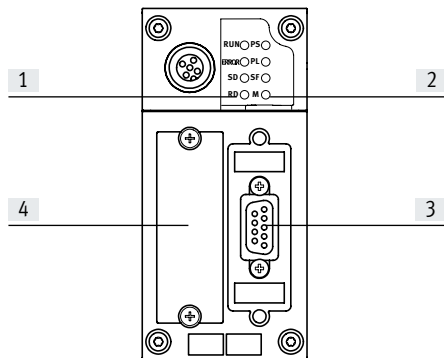



- [1] Bus-specific status LEDs
- [2] CPX-specific status LEDs
- [3] Fieldbus interface (Sub-D socket, 9-pin)
- [4] DIL switch cover

Pin allocation for the CC-Link interface

Terminal allocation	Pin	Signal	Designation
Sub-D socket			
	1	n.c.	Not connected
	2	DA	Data A
	3	DG	Data reference potential
	4	n.c.	Not connected
	5	FE ¹⁾	Functional earth
	6	n.c.	Not connected
	7	DB	Data B
	8	n.c.	Not connected
	9	n.c.	Not connected
Screw terminal bus connection			
	1	FG	Functional earth/housing
	2	SLD	Shielding
	3	DG	Data reference potential
	4	DB	Data B
	5	DA	Data A

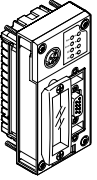
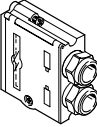
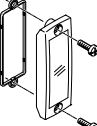
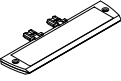
Data sheet – CC-Link bus node

Ordering data		Part no.	Type
Designation			
Bus node			
	CC-Link bus node	526176	CPX-FB23-24
Bus connection			
	Sub-D plug	532220	FBS-SUB-9-GS-2x4POL-B
	Inspection cover, transparent	533334	AK-SUB-9/15-B
	Inscription label holder for connection block	536593	CPX-ST-1
	5-pin M12 to mini USB socket adapter and controller software	547432	NEFC-M12G5-0.3-U1G5
User documentation			
	User documentation for bus node CPX-FB23-24	German	526403 P.BE-CPX-FB23-24-DE
		English	526404 P.BE-CPX-FB23-24-EN
		Chinese	8026069 P.BE-CPX-FB23-24-ZH

Data sheet – PROFINET bus node, M12, D-coded



Bus node for operating the CPX valve terminal on PROFINET.

The bus node is provided with system supply via the interlinking block and processes communication with the I/O modules.

The status of the CPX terminal is displayed as a common message via 4 CPX-specific LEDs.

The fieldbus communication status is displayed via three bus-specific LEDs.



Application

Bus connection

The bus connection is established via two M12 sockets, D-coded to IEC 61076-2-101 with degree of protection IP65, IP67.

Both connections are equivalent 100BaseTX Ethernet ports with integrated auto MDI functionality (crossover and patch cables can be used) that are brought together via an internal switch.

- Maximum segment length 100 m
- Transmission rate 100 Mbps

PROFINET implementation

The bus nodes support the PROFINET protocol on the basis of the Ethernet standard and TCP/IP technology to IEEE802.3.

This guarantees a data exchange with a high data transmission rate, for example I/O data from sensors, actuators or robot controllers, PLCs or process equipment. In addition, non-real-time critical information such as diagnostic

information, configuration information, etc. can be transferred. The Ethernet bandwidth is sufficient to transfer both data types (real-time and non-real-time) in parallel.

The bus node features LEDs for bus status and CPX peripheral information as well as switch elements and a diagnostic interface. PROFINET provides the user with access to all peripherals, diagnostic data and parameter data of the CPX valve terminal. The bus node can be used as a remote I/O or remote controller. All information relevant to the CPX can be read out and, depend-

ent on the function, changed via CPX-FMT.

Points to note in connection with CPX-CEC

When a bus node is combined with a control block (CPX-CEC, in the fieldbus remote controller operating mode), the connected I/Os and/or valves, sensors and actuators are controlled via the CPX control block.

In this case, the bus node only provides the communication interface to the PLC.

Communication between the control block and CPX bus node takes place by interlinking the CPX modules and takes

up the following address capacity in the CPX system:

- 8 byte outputs
- 8 byte inputs

The following address capacity remains in the control block or CPX system for activating the peripherals:

- 56 byte inputs
- 56 byte outputs

Data sheet – PROFINET bus node, M12, D-coded

General technical data			
Type	CPX-FB43		
Fieldbus interface	2x socket, M12, 4-pin, D-coded		
Baud rate	[Mbps]	100	
Protocol	PROFINET RT PROFINET IRT		
Max. address capacity	Inputs	[byte]	64
	Outputs	[byte]	64
LED displays	(bus-specific)		M/P = Maintenance/PROFenergy NF = Network fault TP1 = Network active port 1 TP2 = Network active port 2
	(product-specific)		M = Modify, parameterisation PL = Load supply PS = Electronic supply, sensor supply SF = System fault
Device-specific diagnostics	<ul style="list-style-type: none"> Channel and module-oriented diagnostics Undervoltage of modules Diagnostic memory 		
Configuration support	GSDML file		
Parameterisation	<ul style="list-style-type: none"> System parameters Diagnostic behaviour Signal setup Fail-safe response Forcing of channels 		
Additional functions	<ul style="list-style-type: none"> Start-up parameterisation in plain text via fieldbus Fast start-up (FSU) Channel-oriented diagnostics via fieldbus Acyclic data access via fieldbus and via Ethernet System status can be displayed using process data Additional diagnostic interface for operator unit 		
	<ul style="list-style-type: none"> I&M LLDP MRP MRPD MQTT PROFIsafe PROFenergy S2 system redundancy 		
Control elements	<ul style="list-style-type: none"> DIL switch 		
Operating voltage	Nominal value	[V DC]	24
	Permissible range	[V DC]	18 ... 30
Current consumption		[mA]	Typically 70
Degree of protection to EN 60529	IP65, IP67		
Temperature range	Operation	[°C]	-5 ... +50
	Storage/transport	[°C]	-20 ... +70
Certification	RCM		
Materials	Housing	Die-cast aluminium	
Note on materials	RoHS-compliant		
PWIS conformity	VDMA24364-B2-L		
Dimensions (including interlinking block) W x L x H		[mm]	50 x 107 x 50
Product weight		[g]	185

**Note**

Please observe the general limits and guidelines for the system when configuring the electrical modules.

**Note**

Always use the correct screws for the interlinking block; this depends on whether the block is made of metal or plastic:

- Self-tapping screws for plastic interlinking blocks
- Screws with metric thread for metal interlinking blocks

Data sheet – PROFINET bus node, M12, D-coded

Connection and display components

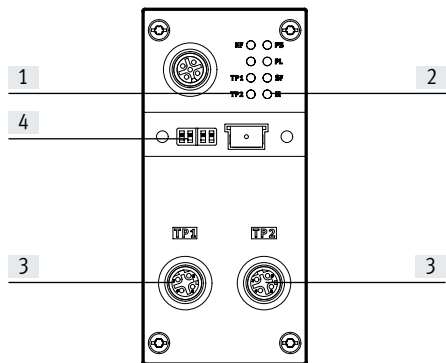



- [1] Bus-specific status LEDs
- [2] CPX-specific status LEDs
- [3] Fieldbus interface (M12 socket, 4-pin, D-coded)
- [4] Transparent cover for DIL switch

Pin allocation for the fieldbus interface

Terminal allocation	Pin	Signal	Designation
Socket, M12, D-coded			
	1	TD+	Transmitted data+
	2	RD+	Received data+
	3	TD-	Transmitted data-
	4	RD-	Received data-
	Housing		Shielding

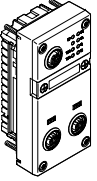
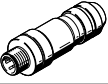
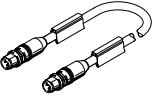
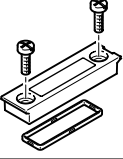
Data sheet – PROFINET bus node, M12, D-coded

Ordering data			Part no.	Type	
Designation					
Bus node					
	PROFINET bus node	<ul style="list-style-type: none"> • I&M • LLDP • MRP • MRPD • PROFIenergy • S2 system redundancy 	8110369	CPX-FB43	
Bus connection					
	Plug M12x1, 4-pin, D-coded		543109	NECU-M-S-D12G4-C2-ET	
	Connecting cable, straight plug, M12x1, 4-pin, D-coded	Straight plug, M12x1, 4-pin, D-coded	0.5 m	8040446	NEBC-D12G4-ES-0.5-S-D12G4-ET
			1 m	8040447	NEBC-D12G4-ES-1-S-D12G4-ET
			3 m	8040448	NEBC-D12G4-ES-3-S-D12G4-ET
			5 m	8040449	NEBC-D12G4-ES-5-S-D12G4-ET
			10 m	8040450	NEBC-D12G4-ES-10-S-D12G4-ET
		Straight plug, RJ45, 8-pin	1 m	8040451	NEBC-D12G4-ES-1-S-R3G4-ET
			3 m	8040452	NEBC-D12G4-ES-3-S-R3G4-ET
5 m	8040453		NEBC-D12G4-ES-5-S-R3G4-ET		
Open end, 4-wire	10 m	8040454	NEBC-D12G4-ES-10-S-R3G4-ET		
5 m	8040456	NEBC-LE4-ES-5-D12G4-ET			
	Transparent cover for DIL switch		548757	CPX-AK-P	
	Cover cap for sealing unused bus connections (10 pieces)		165592	ISK-M12	
User documentation					
	Electronics manual, CPX bus node	German	548759	CPX-(M)-FB33_35/43_45-DE	
		English	548760	CPX-(M)-FB33_35/43_45-EN	
		Spanish	548761	CPX-(M)-FB33_35/43_45-ES	
		French	548762	CPX-(M)-FB33_35/43_45-FR	
		Italian	548763	CPX-(M)-FB33_35/43_45-IT	

Data sheet – PROFINET bus node, push-pull RJ45



Bus node for operating the CPX valve terminal on PROFINET.

The bus node is provided with system supply via the interlinking block and processes communication with the I/O modules.

The status of the CPX terminal is displayed as a common message via 4 CPX-specific LEDs.

The fieldbus communication status is displayed via 4 bus-specific LEDs.



Application

Bus connection

The bus connection is established via two RJ45 push-pull sockets to IEC 61076-3-106 and IEC 60603 with degree of protection IP65, IP67.

Both connections are equivalent 100BaseTX Ethernet ports with integrated auto MDI functionality (crossover and patch cables can be used) that are brought together via an internal switch.

- Maximum segment length 100 m
- Transmission rate 100 Mbps

PROFINET implementation

The bus nodes support the PROFINET protocol on the basis of the Ethernet standard and TCP/IP technology to IEEE802.3.

This guarantees a data exchange with a high data transmission rate, for example I/O data from sensors, actuators or robot controllers, PLCs or process equipment. In addition, non-real-time critical information such as diagnostic

information, configuration information, etc. can be transferred.

The Ethernet bandwidth is sufficient to transfer both data types (real-time and non-real-time) in parallel.

The bus nodes feature LEDs for bus status and CPX peripheral information as well as switch elements and a diagnostic interface. PROFINET provides the user with access to all peripherals, diagnostic data and parameter data of the CPX valve terminal. The bus node can be used as a remote I/O or remote controller. All information relevant to the CPX can be read out and, depend-

ent on the function, changed via CPX-FMT.

Points to note in connection with CPX-CEC

When a bus node is combined with a control block (CPX-CEC, in the fieldbus remote controller operating mode), the connected I/Os and/or valves, sensors and actuators are controlled via the CPX control block.

In this case, the bus node only provides the communication interface to the PLC.

Communication between the control block and CPX bus node takes place by interlinking the CPX modules and takes

up the following address capacity in the CPX system:

- 8/16 byte outputs
- 8/16 byte inputs

The following address capacity remains in the control block or CPX system for activating the peripherals:

- 56/48 byte inputs
- 56/48 byte outputs

Data sheet – PROFINET bus node, push-pull RJ45

General technical data			
Type	CPX-M-FB44		
Fieldbus interface	2x RJ45 push-pull socket, AIDA		
Baud rate	[Mbps]	100	
Protocol	PROFINET RT PROFINET IRT		
Max. address capacity	Inputs	[byte]	64
	Outputs	[byte]	64
LED displays	(bus-specific)		M/P = Maintenance/PROFenergy NF = Network fault TP1 = Network active port 1 TP2 = Network active port 2
	(product-specific)		M = Modify, parameterisation PL = Load supply PS = Electronic supply, sensor supply SF = System fault
Device-specific diagnostics	<ul style="list-style-type: none"> Channel and module-oriented diagnostics Undervoltage of modules Diagnostic memory 		
Configuration support	GSDML file		
Parameterisation	<ul style="list-style-type: none"> System parameters Diagnostic behaviour Signal setup Fail-safe response Forcing of channels 		
Additional functions	<ul style="list-style-type: none"> Start-up parameterisation in plain text via fieldbus Fast start-up (FSU) Channel-oriented diagnostics via fieldbus Acyclic data access via fieldbus and via Ethernet System status can be displayed using process data Additional diagnostic interface for operator unit 		
	<ul style="list-style-type: none"> I&M LLDP MRP MRPD MQTT PROFIsafe PROFenergy S2 system redundancy 		
Control elements	<ul style="list-style-type: none"> DIL switch 		
Operating voltage	Nominal value	[V DC]	24
	Permissible range	[V DC]	18 ... 30
Intrinsic current consumption at nominal operating voltage	[mA]	Typically 70	
Degree of protection to EN 60529	IP65, IP67		
Temperature range	Operation	[°C]	- 5... +50
	Storage/transport	[°C]	-20 ... +70
Certification	RCM		
Housing material	Die-cast aluminium		
Note on materials	RoHS-compliant		
PWIS conformity	VDMA24364-B2-L		
Dimensions (including interlinking block) W x L x H	[mm]	50 x 107 x 80	
Product weight	[g]	280	

**Note**

Please observe the general limits and guidelines for the system when configuring the electrical modules.

**Note**

Always use the correct screws for the interlinking block; this depends on whether the block is made of metal or plastic:

- Self-tapping screws for plastic interlinking blocks
- Screws with metric thread for metal interlinking blocks

Data sheet – PROFINET bus node, push-pull RJ45

Connection and display components

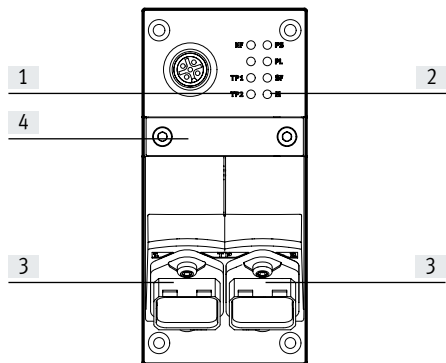



- [1] Bus-specific status LEDs
- [2] CPX-specific status LEDs
- [3] Fieldbus interface (RJ45 socket, 8-pin)
- [4] DIL switch

Pin allocation for the fieldbus interface

Terminal allocation	Pin	Signal	Designation
RJ45 socket			
	1	TD+	Transmitted data+
	2	TD-	Transmitted data-
	3	RD+	Received data+
	4	n.c.	Not connected
	5	n.c.	Not connected
	6	RD-	Received data-
	7	n.c.	Not connected
	8	n.c.	Not connected
	Housing	Shielding	Shielding

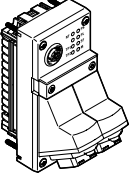
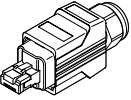
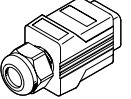
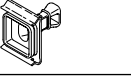
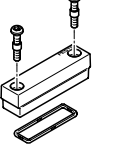
Data sheet – PROFINET bus node, push-pull RJ45

Ordering data		Part no.	Type
Designation			
Bus node			
	PROFINET bus node	<ul style="list-style-type: none"> • I&M • LLDP • MRP • MRPD • PROFinergy • S2 system redundancy 	8110370 CPX-M-FB44
Bus connection			
	RJ45 plug, 8-pin, push-pull		552000 FBS-RJ45-PP-GS
	Cover cap for bus connection		548753 CPX-M-AK-C
	Cover cap for bus connection		2873540 CPX-M-AK-D
	Cover for DIL switch		548754 CPX-M-AK-M
User documentation			
	Electronics manual, CPX bus node	German	548759 CPX-(M)-FB33_35/43_45-DE
		English	548760 CPX-(M)-FB33_35/43_45-EN
		Spanish	548761 CPX-(M)-FB33_35/43_45-ES
		French	548762 CPX-(M)-FB33_35/43_45-FR
		Italian	548763 CPX-(M)-FB33_35/43_45-IT

Data sheet – PROFINET bus node, push-pull SCRJ



Bus node for operating the CPX valve terminal on PROFINET.

The bus node is provided with system supply via the interlinking block and processes communication with the I/O modules.

The status of the CPX terminal is displayed as a common message via 4 CPX-specific LEDs.

The fieldbus communication status is displayed via three bus-specific LEDs.



Application

Bus connection

The bus connection is established via SCRJ push-pull sockets to IEC 61754-24 (fibre-optic cable, AIDA standard) with degree of protection IP65, IP67.

The connections on the CPX bus node are equivalent 100BaseFX Ethernet ports that are brought together via an internal switch.

Fibre-optic cables made from plastic (POF, 980/1000 µm) are also suitable for transmission.

- Maximum segment length 50 m
- Transmission rate 100 Mbps
- Supports LLDP and SNMP

PROFINET implementation

The bus nodes support the PROFINET protocol on the basis of the Ethernet standard and TCP/IP technology to IEEE802.3.

This guarantees a data exchange with a high data transmission rate, for example I/O data from sensors, actuators or robot controllers, PLCs or process equipment. In addition, non-real-time critical information such as diagnostic

information, configuration information, etc. can be transferred.

The Ethernet bandwidth is sufficient to transfer both data types (real-time and non-real-time) in parallel.

The bus node features LEDs for bus status and CPX peripheral information as well as switch elements and a diagnostic interface. PROFINET provides the user with access to all peripheral, diagnostic and parameter data for the CPX valve terminal. The bus node can be used as a remote I/O or remote controller. All information relevant to the

CPX can be read out and, dependent on the function, changed via CPX-FMT.

Points to note in connection with CPX-CEC

When a bus node is combined with a control block (CPX-CEC, in the fieldbus remote controller operating mode), the connected I/Os and/or valves, sensors and actuators are controlled via the CPX control block.

In this case, the bus node only provides the communication interface to the PLC.

Communication between the control block and CPX bus node takes place by interlinking the CPX modules and takes

up the following address capacity in the CPX system:

- 8/16 byte outputs
- 8/16 byte inputs

The following address capacity remains in the control block or CPX system for activating the peripherals:

- 56/48 byte inputs
- 56/48 byte outputs

Data sheet – PROFINET bus node, push-pull SCRJ

General technical data			
Type	CPX-M-FB45		
Fieldbus interface	2x SCRJ push-pull socket, AIDA		
Baud rate	[Mbps]	100	
Protocol	PROFINET RT PROFINET IRT		
Max. address capacity	Inputs	[byte]	64
	Outputs	[byte]	64
LED displays	(bus-specific)		M/P = Maintenance/PROFenergy NF = Network fault TP1 = Network active port 1 TP2 = Network active port 2
	(product-specific)		M = Modify, parameterisation PL = Load supply PS = Electronic supply, sensor supply SF = System fault
Device-specific diagnostics	<ul style="list-style-type: none"> Channel and module-oriented diagnostics Undervoltage of modules Diagnostic memory 		
Configuration support	GSDML file		
Parameterisation	<ul style="list-style-type: none"> System parameters Diagnostic behaviour Signal setup Fail-safe response Forcing of channels 		
Additional functions	<ul style="list-style-type: none"> Start-up parameterisation in plain text via fieldbus Fast start-up (FSU) Channel-oriented diagnostics via fieldbus Acyclic data access via fieldbus and via Ethernet System status can be displayed using process data Additional diagnostic interface for operator unit 		
	<ul style="list-style-type: none"> I&M LLDP MRP MRPD MQTT PROFIsafe PROFenergy S2 system redundancy 		
Control elements	DIL switch		
Operating voltage	Nominal value	[V DC]	24
	Permissible range	[V DC]	18 ... 30
Intrinsic current consumption at nominal operating voltage	[mA]	Typically 145	
Certification	RCM		
Degree of protection to EN 60529	IP65, IP67		
Temperature range	Operation	[°C]	-5... +50
	Storage/transport	[°C]	-20 ... +70
Housing material	Die-cast aluminium		
Note on materials	RoHS-compliant		
PWIS conformity	VDMA24364-B2-L		
Grid dimension	[mm]	50	
Dimensions (including interlinking block) W x L x H	[mm]	50 x 107 x 80	
Product weight	[g]	280	

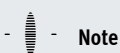
**Note**

Please observe the general limits and guidelines for the system when configuring the electrical modules.

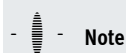
**Note**

Always use the correct screws for the interlinking block; this depends on whether the block is made of metal or plastic:

- Self-tapping screws for plastic interlinking blocks
- Screws with metric thread for metal interlinking blocks

Data sheet – PROFINET bus node, push-pull SCRJ

Connection and display components

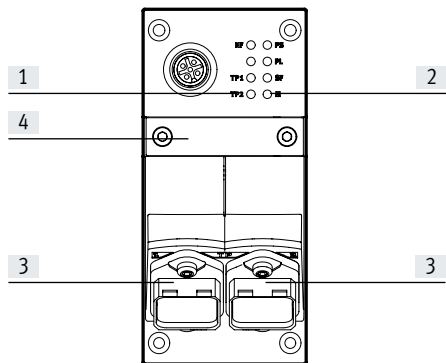





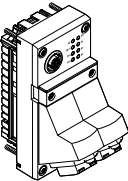
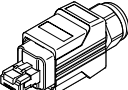
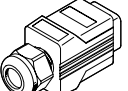

- [1] Bus-specific status LEDs
- [2] CPX-specific status LEDs
- [3] Fieldbus interface (SCRJ) socket, 2-pin)
- [4] DIL switch

Pin allocation for the fieldbus interface

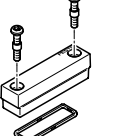
Terminal allocation	Pin	Signal	Designation
SCRJ socket			
	1	TX	Outgoing
	2	Rx	Incoming

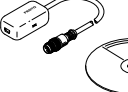
Data sheet – PROFINET bus node, push-pull SCRJ

Ordering data		Part no.	Type
Designation			
Bus node			
	2x SCRJ push-pull socket, AIDA	<ul style="list-style-type: none"> • I&M • LLDP • MRP • MRPD • PROFIenergy • S2 system redundancy 	8110371 CPX-M-FB45
Bus connection			
	SCRJ plug, 2-pin, push-pull		571017 FBS-SCRJ-PP-GS
	Cover cap for bus connection		548753 CPX-M-AK-C
	Cover cap for bus connection		2873540 CPX-M-AK-D
	Cover for DIL switch		548754 CPX-M-AK-M
	Screws for attaching an inscription label to the bus node (12 pieces)		550222 CPX-M-M2.5X8-12X
	5-pin M12 to mini USB socket adapter and controller software		547432 NEFC-M12G5-0.3-U1G5
User documentation			
	Electronics manual, CPX bus node	German	548759 CPX-(M)-FB33_35/43_45-DE
		English	548760 CPX-(M)-FB33_35/43_45-EN
		Spanish	548761 CPX-(M)-FB33_35/43_45-ES
		French	548762 CPX-(M)-FB33_35/43_45-FR
		Italian	548763 CPX-(M)-FB33_35/43_45-IT

Data sheet – EtherNet/IP bus node

- Industrial Ethernet
- EtherNet/IP
- Web interface

Bus node for handling communication between the electrical terminal CPX and the Ethernet/IP network.

The bus node is provided with system supply via the interlinking block and processes communication with the I/O modules.

The status of the CPX terminal is displayed as a common message via 4 CPX-specific LEDs.



Application

Bus connection

The bus connection is established via an M12 plug, D-coded to IEC 947-5-2 with degree of protection IP65, IP67.

EtherNet/IP is an open bus system based on the Ethernet standard and TCP/IP technology (IEEE802.3).

EtherNet/IP implementation

The CPX-FB36 supports the two operating modes: remote I/O and remote controller.

In remote I/O operating mode, all functions of the CPX valve terminal are di-

rectly controlled by the Ethernet/IP master (host).

In addition to activation via a bus system, it is possible to use IT technologies. An integrated web server enables diagnostic data to be visualised via

HTML. Various programs support direct access to the device data from the automation network.

The Ethernet/IP node for CPX supports the transmission technology that con-

forms to DIN EN 50173/CAT 5 as an integrated interface.

Points to note in connection with CPX-CEC

When a bus node is combined with a control block (CPX-CEC, in the fieldbus remote controller operating mode), the connected I/Os and/or valves, sensors and actuators are controlled via the CPX control block.

In this case, the bus node only provides the communication interface to the PLC.

Communication between the control block and CPX bus node takes place by interlinking the CPX modules and takes

up the following address capacity in the CPX system:

- 8 byte outputs
- 8 byte inputs

The following address capacity remains in the control block or CPX system for activating the peripherals:

- 56 byte inputs
- 56 byte outputs

Data sheet – EtherNet/IP bus node

General technical data		
Type		CPX-FB36
Fieldbus interface		2x M12x1 socket, 4-pin, D-coded
Baud rate	[Mbps]	10/100
Protocol		EtherNet/IP Modbus TCP
Max. address capacity, inputs	[byte]	64
Max. address volume for outputs	[byte]	64
LED displays (bus-specific)		MS = Module status NS = network status TP1 = Network active port 1 TP2 = Network active port 2
Device-specific diagnostics		<ul style="list-style-type: none"> • Module and channel-oriented diagnostics • Undervoltage of modules • Diagnostic memory
Configuration support		<ul style="list-style-type: none"> • EDS file • L5K export with CPX-FMT
Parameterisation		<ul style="list-style-type: none"> • Diagnostic behaviour • Fail-safe response • Forcing of channels • Idle mode characteristics • Signal setup • System parameters
Additional functions		<ul style="list-style-type: none"> • EtherNet/IP Quickconnect • Ring topology (DLR) • Acyclic data access via "Explicit Message" and Ethernet • Integrated switch • IP addressing via DHCP, DIL switch or operator unit • Channel-oriented diagnostics via fieldbus • Start-up parameterisation in plain text via fieldbus • System status can be displayed using process data • Additional diagnostic interface for operator units
Control elements		DIL switch
Operating voltage	Nominal value	[V DC] 24
	Permissible range	[V DC] 18 ... 30
Current consumption at nominal voltage	[mA]	Typically 100
Degree of protection to EN 60529		IP65, IP67
Temperature range	Operation	[°C] - 5... +50
	Storage/transport	[°C] -20 ... +70
Materials		PA-reinforced
Note on materials		RoHS-compliant
PWIS conformity		VDMA24364-B2-L
Grid dimension	[mm]	50
Dimensions (including interlinking block) W x L x H	[mm]	50 x 107 x 50
Product weight	[g]	125

 **Note**

Please observe the general limits and guidelines for the system when configuring the electrical modules.

Data sheet – EtherNet/IP bus node

Connection and display components

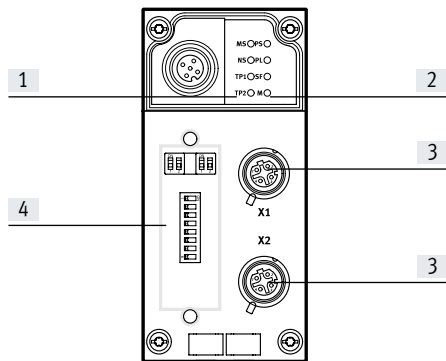

- [1] Bus-specific status LEDs
- [2] CPX-specific status LEDs
- [3] Fieldbus interface (M12 socket, 4-pin, D-coded)
- [4] Transparent DIL switch cover

Pin allocation for the fieldbus interface

Terminal allocation	Pin	Signal	Designation
Socket, M12, D-coded			
	1	TD+	Transmitted data+
	2	RD+	Received data+
	3	TD-	Transmitted data-
	4	RD-	Received data-
	Housing	FE	Shielding

Data sheet – EtherNet/IP bus node

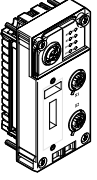
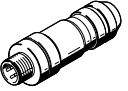
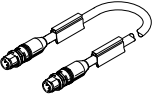
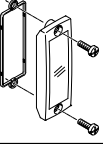
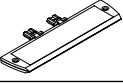
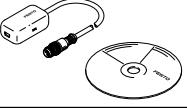
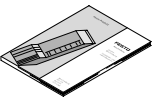
Ordering data				Part no.	Type
Designation					
Bus node					
	EtherNet/IP bus node			1912451	CPX-FB36
Bus connection					
	Plug M12x1, 4-pin, D-coded			543109	NECU-M-S-D12G4-C2-ET
	Connecting cable, straight plug, M12x1, 4-pin, D-coded	Straight plug, M12x1, 4-pin, D-coded	0.5 m	8040446	NEBC-D12G4-ES-0.5-S-D12G4-ET
			1 m	8040447	NEBC-D12G4-ES-1-S-D12G4-ET
			3 m	8040448	NEBC-D12G4-ES-3-S-D12G4-ET
			5 m	8040449	NEBC-D12G4-ES-5-S-D12G4-ET
			10 m	8040450	NEBC-D12G4-ES-10-S-D12G4-ET
	Straight plug, RJ45, 8-pin	1 m	8040451	NEBC-D12G4-ES-1-S-R3G4-ET	
		3 m	8040452	NEBC-D12G4-ES-3-S-R3G4-ET	
		5 m	8040453	NEBC-D12G4-ES-5-S-R3G4-ET	
		10 m	8040454	NEBC-D12G4-ES-10-S-R3G4-ET	
Open end, 4-wire	5 m	8040456	NEBC-LE4-ES-5-D12G4-ET		
	Inspection cover, transparent			533334	AK-SUB-9/15-B
	Inscription label holder for connection block			536593	CPX-ST-1
	5-pin M12 to mini USB socket adapter and controller software			547432	NEFC-M12G5-0.3-U1G5
User documentation					
	User documentation for bus node CPX-FB36		German	8024074	CPX-FB36-DE
			English	8024075	CPX-FB36-EN
			Spanish	8024076	CPX-FB36-ES
			French	8024077	CPX-FB36-FR
			Italian	8024078	CPX-FB36-IT
			Chinese	8024079	CPX-FB36-ZH

Data sheet – EtherCAT bus node



Bus node for operating the CPX valve terminal on EtherCAT.

The bus node is provided with system supply via the interlinking block and processes communication with the I/O modules.

The status of the CPX terminal is displayed as a common message via 4 CPX-specific LEDs.

The fieldbus communication status is displayed via 4 bus-specific LEDs.

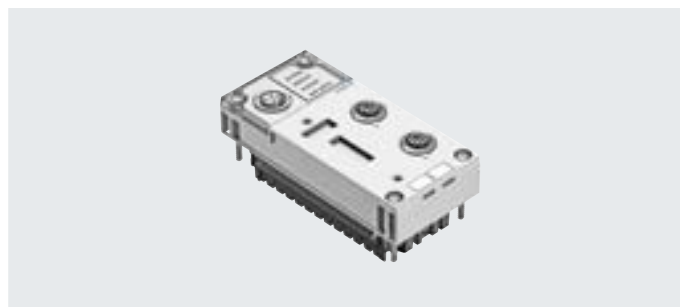

Application

Bus connection

The bus connection is established via two sockets M12x1, D-coded to IEC 61076-2-101 with degree of protection IP65, IP67.

Both connections are equivalent 100BaseTX Ethernet ports with integrated auto MDI functionality (crossover and patch cable can be used) that are brought together via an internal switch.

- Maximum segment length 100 m
- Transmission rate 100 Mbps

EtherCAT implementation

The CPX-FB37 supports the EtherCAT protocol on the basis of the Ethernet standard and TCP/IP technology to IEEE802.3.

This guarantees a data exchange with a high data transmission rate, for example I/O data from sensors, actuators or robot controllers, PLCs or process equipment. In addition, non-real-time critical information such as diagnostic information, configuration information, etc. can be transferred.

The data bandwidth is sufficient to transfer both data types (real-time and non-real-time) in parallel.

The bus node features LEDs for bus status and CPX peripheral information as well as switch elements and a diagnostic interface. The bus node can be used as a remote I/O or remote controller. All information relevant to the CPX can be read out and, dependent on the function, changed via CPX-FMT. The functions MDP (modular device profile) and CoE (CAN over EtherCAT) enable easy access to parameters and diagnostic data via EtherCAT.

Specific EtherCAT functions:

- CoE (parameters and diagnostics or fail-safe mode): all module parameters can be set
- FoE (file over EtherCAT) makes it possible to download firmware easily
- EoE (Ethernet over EtherCAT): diagnostic data can be retrieved easily using a browser
- MDP (modular device profile): easy configuration using a module selection box
- Hot Connect, easy replacement of an EtherCAT CPX terminal
- DC (distributed clocks), time-synchronised data transmission

Points to note in connection with CPX-CEC

When a bus node is combined with a control block (CPX-CEC, in the fieldbus remote controller operating mode), the connected I/Os and/or valves, sensors and actuators are controlled via the CPX control block.

In this case, the bus node only provides the communication interface to the PLC.

Communication between the control block and CPX bus node takes place by interlinking the CPX modules and takes

up the following address capacity in the CPX system:

- 8/16 byte outputs
- 8/16 byte inputs

The following address capacity remains in the control block or CPX system for activating the peripherals:

- 56/48 byte inputs
- 56/48 byte outputs

Data sheet – EtherCAT bus node

General technical data			
Type	CPX-FB37		
Fieldbus interface	2x M12x1 socket, 4-pin, D-coded		
Baud rate	[Mbps]	100	
Protocol	EtherCAT		
Max. address capacity	Inputs	[byte]	64
	Outputs	[byte]	64
LED displays	Bus-specific		Error = Communication error L/A1 = Network active port 1 L/A2 = Network active port 2 Run = Communication status
	Product-specific		M = Modify, parameterisation PL = Load supply PS = Electronic supply, sensor supply SF = System fault
Device-specific diagnostics	<ul style="list-style-type: none"> Channel and module-oriented diagnostics Undervoltage of modules Diagnostic memory 		
Configuration support	ESI file		
Parameterisation	<ul style="list-style-type: none"> System parameters Diagnostic behaviour Signal setup Fail-safe response Forcing of channels 		
Additional functions	<ul style="list-style-type: none"> System status can be displayed using process data Additional diagnostic interface for operator units Emergency message Acyclic data access via fieldbus Diagnostics object Compatibility mode with CPX-FB38 Modular device profile (MDP) Variable PDO mapping 		
Control elements	DIL switch		
Operating voltage	Nominal value	[V DC]	24
	Permissible range	[V DC]	18 ... 30
Current consumption			Typically 100
Degree of protection to EN 60529	IP65, IP67		
Temperature range	Operation	[°C]	- 5... +50
	Storage/transport	[°C]	-20 ... +70
Materials	Housing		PA-reinforced
Note on materials	RoHS-compliant		
PWIS conformity	VDMA24364-B2-L		
Grid dimension			[mm] 50
Dimensions (including interlinking block) W x L x H			[mm] 50 x 107 x 50
Product weight			[g] 125

 - **Note**

Please observe the general limits and guidelines for the system when configuring the electrical modules.

 - **Note**

Always use the correct screws for the interlinking block; this depends on whether the block is made of metal or plastic:

- Self-tapping screws for plastic interlinking blocks
- Screws with metric thread for metal interlinking blocks

Data sheet – EtherCAT bus node

Connection and display components

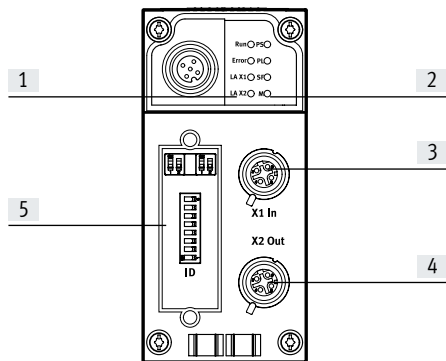





- [1] Bus-specific status LEDs
- [2] CPX-specific status LEDs
- [3] Fieldbus interface, input (socket M12x1, 4-pin, D-coded)
- [4] Fieldbus interface, output (socket M12x1, 4-pin, D-coded)
- [5] DIL switch

Pin allocation for the fieldbus interface

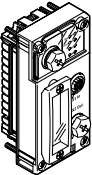
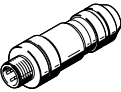
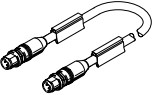
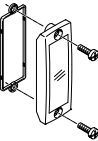
Terminal allocation	Pin	Signal	Designation
M12x1 socket, D-coded			
	1	TD+	Transmitted data+
	2	RD+	Received data+
	3	TD-	Transmitted data-
	4	RD-	Received data-
	Housing	FE	Shielding

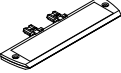
Data sheet – EtherCAT bus node

Ordering data		Part no.	Type		
Designation					
Bus node					
	EtherCAT bus node	2735960	CPX-FB37		
Bus connection					
	Plug M12x1, 4-pin, D-coded	543109	NECU-M-S-D12G4-C2-ET		
	Connecting cable, straight plug, M12x1, 4-pin, D-coded	Straight plug, M12x1, 4-pin, D-coded	0.5 m	8040446	NEBC-D12G4-ES-0.5-S-D12G4-ET
			1 m	8040447	NEBC-D12G4-ES-1-S-D12G4-ET
			3 m	8040448	NEBC-D12G4-ES-3-S-D12G4-ET
			5 m	8040449	NEBC-D12G4-ES-5-S-D12G4-ET
			10 m	8040450	NEBC-D12G4-ES-10-S-D12G4-ET
		Straight plug, RJ45, 8-pin	1 m	8040451	NEBC-D12G4-ES-1-S-R3G4-ET
			3 m	8040452	NEBC-D12G4-ES-3-S-R3G4-ET
			5 m	8040453	NEBC-D12G4-ES-5-S-R3G4-ET
Open end, 4-wire	10 m	8040454	NEBC-D12G4-ES-10-S-R3G4-ET		
	5 m	8040456	NEBC-LE4-ES-5-D12G4-ET		
	Inspection cover, transparent	533334	AK-SUB-9/15-B		
	Cover cap for sealing unused bus connections (10 pieces)	165592	ISK-M12		
	Inscription label holder for connection block	536593	CPX-ST-1		
	5-pin M12 to mini USB socket adapter and controller software	547432	NEFC-M12G5-0.3-U1G5		
User documentation					
	Electronics manual, CPX bus node, type CPX-FB37	German	8029674	P.BE-CPX-FB37-DE	
		English	8029675	P.BE-CPX-FB37-EN	
		Spanish	8029676	P.BE-CPX-FB37-ES	
		French	8029677	P.BE-CPX-FB37-FR	
		Italian	8029678	P.BE-CPX-FB37-IT	
		Chinese	8029679	P.BE-CPX-FB37-ZH	

Data sheet – Sercos III bus node

- Sercos
- Web interface

Bus node for handling communication between the electrical terminal CPX and the Sercos III network.

The bus node is provided with system supply via the interlinking block and processes communication with the I/O modules.

The status of the CPX terminal is displayed as a common message via 4 CPX-specific LEDs.

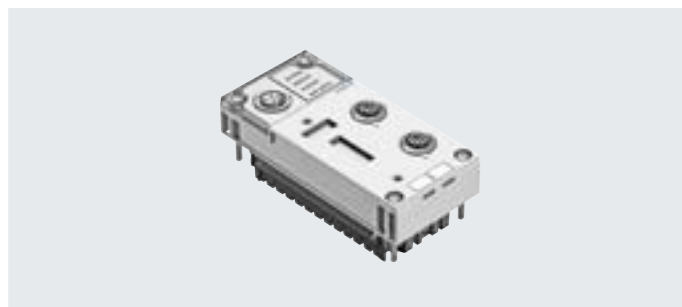

Application

Bus connection

The bus connection is established via two M12x1 plugs, D-coded to IEC 947-5-2 with degree of protection to IP65, IP67. The connections are equipped with automatic detection for the incoming and outgoing connection.

The Sercos III bus node can be used to connect the CPX valve terminal to the standardised Sercos III bus.

Sercos III uses the Ethernet standard (IEEE802.3) and TCP/IP technology for communication in an industrial environment.

Industry-compatible Sercos III devices enable data to be exchanged with a higher data transmission rate, such as data from sensors, actuators or controllers.

Non-real-time critical information, such as diagnostics or configuration information, can also be transferred.

Web servers

In addition to activation via a bus system, it is possible to use IT technologies. An integrated web server enables

diagnostic data to be visualised via HTML. Various programs support direct

access to the device data from the automation network.

Points to note in connection with CPX-CEC

The CPX-FB39 supports the operating modes remote I/O and remote controller.

In remote I/O operating mode, all functions of the CPX valve terminal are directly controlled by the Sercos controller.

When a bus node is combined with a control block (CPX-CEC, in the fieldbus

remote controller operating mode), the connected I/Os and/or valves, sensors and actuators are controlled via the CPX control block.

In this case, the bus node only provides the communication interface to the PLC.

Communication between the control block and CPX bus node takes place by

interlinking the CPX modules and takes up the following address capacity in the CPX system:

- 8/16 byte outputs
- 8/16 byte inputs

The following address capacity remains in the control block or CPX system for activating the peripherals:

- 56/48 byte inputs

Data sheet – Sercos III bus node

General technical data			
Type	CPX-FB39		
Fieldbus interface	2x M12x1 socket, D-coded, 4-pin		
Baud rate	[Mbps]	100 full/half duplex	
Protocol	Sercos III		
Max. address capacity	Inputs	[byte]	64
	Outputs	[byte]	64
LED displays	Bus-specific		S = Sercos LED SD = Sercos sub-device LED TP1 = Network active port 1 TP2 = Network active port 2
	Product-specific		M = Modify, parameterisation PL = Load supply PS = Electronics supply, sensor supply SF = System fault
Device-specific diagnostics			
<ul style="list-style-type: none"> • Module and channel-oriented diagnostics • Undervoltage of modules • Diagnostic memory 			
Configuration support	SDDML file		
Parameterisation			
<ul style="list-style-type: none"> • Diagnostic behaviour • Fallback output data • Forcing of channels • Signal setup • System parameters 			
Additional functions			
<ul style="list-style-type: none"> • Acyclic and cyclic data access via Sercos • IP addressing via Sercos parameters or operator unit • Channel-oriented diagnostics via fieldbus • Start-up parameterisation in plain text via fieldbus • System status can be displayed using process data • Additional diagnostic interface for operator units 			
Control elements			
DIL switch			
Operating voltage	Nominal value	[V DC]	24
	Permissible range	[V DC]	18 ... 30
Current consumption at nominal voltage			[mA]
			Typically 100
Degree of protection to EN 60529			
IP65, IP67			
Temperature range	Operation	[°C]	- 5... +50
	Storage/transport	[°C]	-20 ... +70
Materials			
PA-reinforced			
Note on materials			
RoHS-compliant			
PWIS conformity			
VDMA24364-B2-L			
Grid dimension			[mm]
			50
Dimensions (including interlinking block) W x L x H			
			[mm]
			50 x 107 x 50
Product weight			
			[g]
			125

 **Note**

Please observe the general limits and guidelines for the system when configuring the electrical modules.

Data sheet – Sercos III bus node

Connection and display components

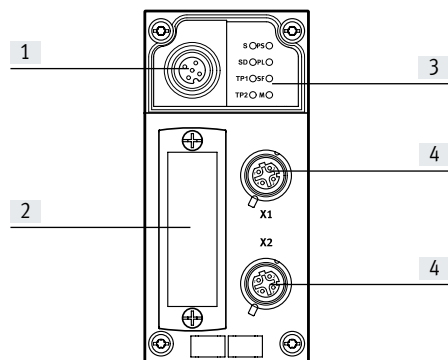





- [1] Service interface for PC with CPX maintenance tool NEFC-M12G5-0.3-U1G5
- [2] Transparent DIL switch cover
- [3] Status LED, bus-specific and CPX-specific
- [4] Fieldbus interface (M12x1 socket, 4-pin, D-coded)

Pin allocation for the fieldbus interface

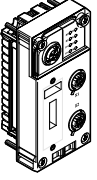
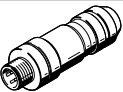
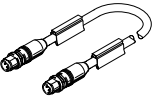
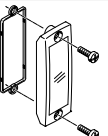
Terminal allocation	Pin	Signal	Designation
M12x1 socket, D-coded			
	1	TD+	Transmitted data+
	2	RD+	Received data+
	3	TD-	Transmitted data-
	4	RD-	Received data-
	Housing	FE	Shielding
<p> Note</p> <p>The CPX-FB39 can automatically detect transmitter and receiver cables (auto-MDI/MDI-X auto-crossover).</p> <p>RD and TD signal pairs are automatically swapped if required.</p>			

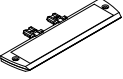
Data sheet – Sercos III bus node

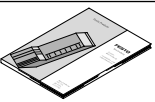
Ordering data			Part no.	Type	
Designation					
Bus node					
	Ethernet Sercos III bus node		2093101	CPX-FB39	
Bus connection					
	Plug M12x1, 4-pin, D-coded		543109	NECU-M-S-D12G4-C2-ET	
	Connecting cable, straight plug, M12x1, 4-pin, D-coded	Straight plug, M12x1, 4-pin, D-coded	0.5 m	8040446	NEBC-D12G4-ES-0.5-S-D12G4-ET
			1 m	8040447	NEBC-D12G4-ES-1-S-D12G4-ET
			3 m	8040448	NEBC-D12G4-ES-3-S-D12G4-ET
			5 m	8040449	NEBC-D12G4-ES-5-S-D12G4-ET
	Straight plug, RJ45, 8-pin	10 m	8040450	NEBC-D12G4-ES-10-S-D12G4-ET	
		1 m	8040451	NEBC-D12G4-ES-1-S-R3G4-ET	
		3 m	8040452	NEBC-D12G4-ES-3-S-R3G4-ET	
		5 m	8040453	NEBC-D12G4-ES-5-S-R3G4-ET	
Open end, 4-wire	10 m	8040454	NEBC-D12G4-ES-10-S-R3G4-ET		
	5 m	8040456	NEBC-LE4-ES-5-D12G4-ET		
	Inspection cover, transparent		533334	AK-SUB-9/15-B	
	Cover cap for sealing unused bus connections (10 pieces)		165592	ISK-M12	
	Inscription label holder for connection block		536593	CPX-ST-1	
	5-pin M12 to mini USB socket adapter and controller software		547432	NEFC-M12G5-0.3-U1G5	
User documentation					
	User documentation for bus node CPX-FB39		German	8028632	P.BE-CPX-FB39-DE
			English	8028633	P.BE-CPX-FB39-EN
			Spanish	8028634	P.BE-CPX-FB39-ES
			French	8028635	P.BE-CPX-FB39-FR
			Italian	8028636	P.BE-CPX-FB39-IT
			Chinese	8028637	P.BE-CPX-FB39-ZH

Data sheet – POWERLINK bus node

- Ethernet POWERLINK
- Web interface

Bus node for handling communication between the electrical terminal CPX and the Ethernet POWERLINK network. The bus node is provided with system supply via the interlinking block and processes communication with the I/O modules.

The status of the CPX terminal is displayed as a common message via 4 CPX-specific LEDs.

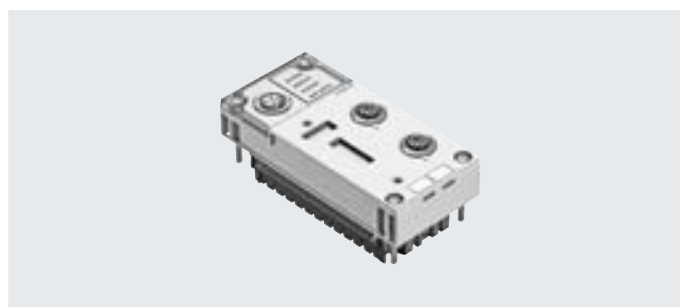

Application

Bus connection

The bus connection is established via an M12x1 plug, D-coded to IEC 947-5-2 with degree of protection IP65, IP67. Ethernet POWERLINK uses the Ethernet standards and TCP/IP technology (IEEE802.3) for communication in an industrial environment and integrates all CANopen mechanisms.

It includes all the key features of standard Ethernet, including internode communication, hotplug capability and free selection of network topology. Ethernet POWERLINK fulfils the real-time requirements using a mix of timeslot and polling procedures. In other words, defined times are re-

served on the Ethernet cable exclusively for transferring real-time data. Only network participants which have previously been prompted by the controller are able to transmit data during these timeslots.

Ethernet POWERLINK implementation

The CPX-FB40 supports the two operating modes: remote I/O and remote controller.

In remote I/O operating mode, all functions of the CPX valve terminal are di-

rectly controlled by the Ethernet POWERLINK master (host). In addition to activation via a bus system, it is possible to use IT technologies. An integrated web server enables diagnostic data to be visualised via

HTML. Various programs support direct access to the device data from the automation network.

The Ethernet POWERLINK node for CPX supports the transmission technology

that conforms to DIN EN 50173/CAT 5 as an integrated interface.

Points to note in connection with CPX-CEC

When a bus node is combined with a control block (CPX-CEC, in the fieldbus remote controller operating mode), the connected I/Os and/or valves, sensors and actuators are controlled via the CPX control block.

In this case, the bus node only provides the communication interface to the PLC.

Communication between the control block and CPX bus node takes place by interlinking the CPX modules and takes

up the following address capacity in the CPX system:

- 8 byte outputs
- 8 byte inputs

The following address capacity remains in the control block or CPX system for activating the peripherals:

- 56 byte inputs
- 56 byte outputs

Data sheet – POWERLINK bus node

General technical data			
Type	CPX-FB40		
Fieldbus interface	2x M12x1 socket, D-coded, 4-pin		
Baud rate	[Mbps]	100	
Protocol	Ethernet PowerLink V2		
Max. address capacity	Inputs	[byte]	64
	Outputs	[byte]	64
LED displays	Bus-specific		BE = POWERLINK error BS = POWERLINK status L/A1 = Link/activity port 1 L/A2 = Link/activity port 2
	Product-specific		M = Modify, parameterisation PL = Load supply PS = Electronic supply, sensor supply SF = System fault
Device-specific diagnostics	<ul style="list-style-type: none"> Module and channel-oriented diagnostics Undervoltage of modules Diagnostic memory 		
Configuration support	<ul style="list-style-type: none"> XDC file XDD file 		
Parameterisation	<ul style="list-style-type: none"> Diagnostic behaviour Fail-safe response Forcing of channels Signal setup System parameters 		
Additional functions	<ul style="list-style-type: none"> Acyclic data access via "SDO" and Ethernet Integrated hub IP addressing via DHCP, DIL switch or operator unit Channel-oriented diagnostics via fieldbus Start-up parameterisation in plain text via fieldbus System status can be displayed using process data Additional diagnostic interface for operator units 		
Control elements	DIL switch		
Operating voltage	Nominal value	[V DC]	24
	Permissible range	[V DC]	18 ... 30
	Reverse polarity protection	For operating voltage	
Current consumption at nominal voltage	[mA]	Typically 100	
Degree of protection to EN 60529	IP65, IP67		
Temperature range	Operation	[°C]	- 5... +50
	Storage/transport	[°C]	-20 ... +70
Materials	PA-reinforced		
Note on materials	RoHS-compliant		
PWIS conformity	VDMA24364-B2-L		
Grid dimension	[mm]	50	
Dimensions (including interlinking block) W x L x H	[mm]	50 x 107 x 50	
Product weight	[g]	125	

 **Note**

Please observe the general limits and guidelines for the system when configuring the electrical modules.

Data sheet – POWERLINK bus node

Connection and display components

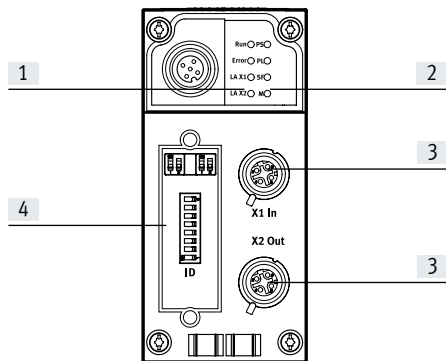



- [1] Bus-specific status LEDs
- [2] CPX-specific status LEDs
- [3] Fieldbus interface (M12x1 socket, 4-pin, D-coded)
- [4] Transparent DIL switch cover

Pin allocation for the fieldbus interface

Terminal allocation	Pin	Signal	Designation
M12x1 socket, D-coded			
	1	TD+	Transmitted data+
	2	RD+	Received data+
	3	TD-	Transmitted data-
	4	RD-	Received data-
	Housing	FE	Shielding

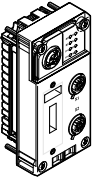
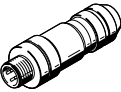
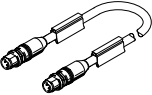
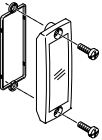
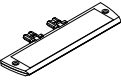
Data sheet – POWERLINK bus node

Ordering data		Part no.	Type		
Bus node					
	Ethernet POWERLINK bus node	2474896	CPX-FB40		
Bus connection					
	Plug M12x1, 4-pin, D-coded	543109	NECU-M-S-D12G4-C2-ET		
	Connecting cable, straight plug, M12x1, 4-pin, D-coded	Straight plug, M12x1, 4-pin, D-coded	0.5 m	8040446	NEBC-D12G4-ES-0.5-S-D12G4-ET
			1 m	8040447	NEBC-D12G4-ES-1-S-D12G4-ET
			3 m	8040448	NEBC-D12G4-ES-3-S-D12G4-ET
			5 m	8040449	NEBC-D12G4-ES-5-S-D12G4-ET
			10 m	8040450	NEBC-D12G4-ES-10-S-D12G4-ET
		Straight plug, RJ45, 8-pin	1 m	8040451	NEBC-D12G4-ES-1-S-R3G4-ET
			3 m	8040452	NEBC-D12G4-ES-3-S-R3G4-ET
			5 m	8040453	NEBC-D12G4-ES-5-S-R3G4-ET
	Open end, 4-wire	10 m	8040454	NEBC-D12G4-ES-10-S-R3G4-ET	
		5 m	8040456	NEBC-LE4-ES-5-D12G4-ET	
	Inspection cover, transparent	533334	AK-SUB-9/15-B		
	Inscription label holder for connection block	536593	CPX-ST-1		
	5-pin M12 to mini USB socket adapter and controller software	547432	NEFC-M12G5-0.3-U1G5		
User documentation					
	User documentation for bus node CPX-FB40	German	8028650	P.BE-CPX-FB40-DE	
		English	8028651	P.BE-CPX-FB40-EN	
		Spanish	8028652	P.BE-CPX-FB40-ES	
		French	8028653	P.BE-CPX-FB40-FR	
		Italian	8028654	P.BE-CPX-FB40-IT	
		Chinese	8028655	P.BE-CPX-FB40-ZH	

Data sheet – Interface for CPI system

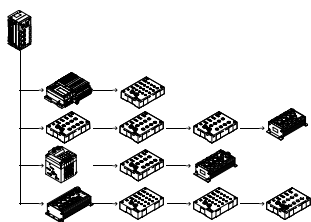

The electrical interface CPX-CP establishes the connection to CP modules of the installation system CPI via pre-assembled connecting cables. The I/O data of the connected valve terminals with CP string extension and CP input and output modules are transferred to the connected CPX bus node and thus via fieldbus to the higher-order controller.

This enables modular centralised and compact decentralised concepts to be established with one system.

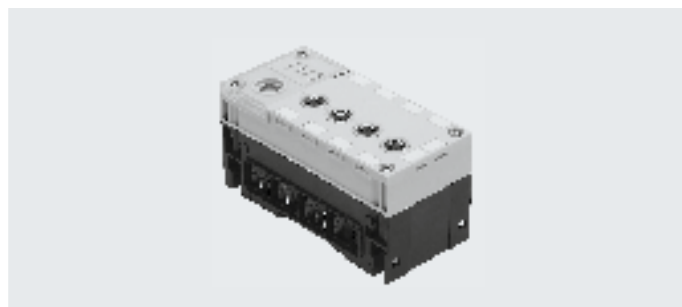

Application

CP connection

As well as transmitting the communication data, the max. 4 CP strings of a CPX-CP interface also transmit the power supply to the connected sensors and the load supply to the valves (or outputs). Both circuits are supplied separately with 24 V but using a common reference potential.

The valve terminals with CP string extension (or outputs) are supplied with voltage for the electronics and valves by the interlinking block.

The CP interface allows the following combinations:

- Centralised analogue and digital inputs and outputs of the CPX terminal
- Decentralised digital inputs and outputs of the CP installation system
- Valve/valve terminals that can be connected both centrally and decentraly

Configuration example – CP interface with CP modules

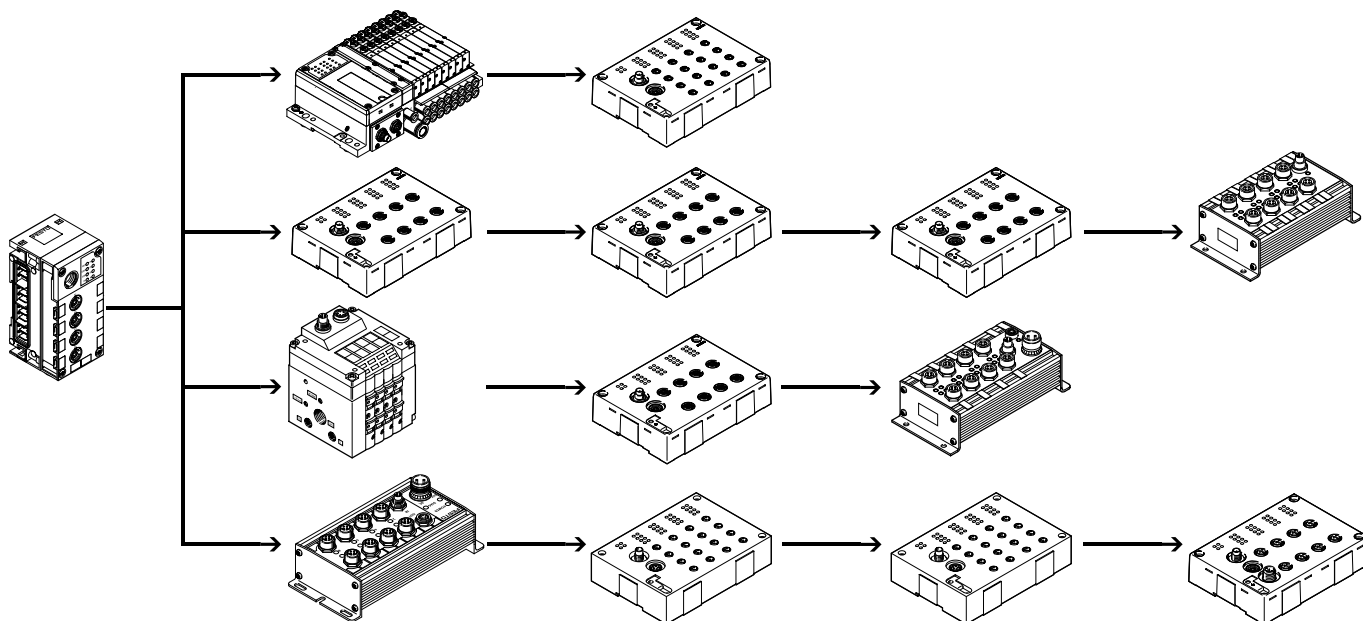

Data sheet – Interface for CPI system

Implementation

The CPX-CP interface supports the CPI system:

- Max. 4 individual electronically protected CP strings
- Max. 4 CP modules per string
- Max. 32 inputs/32 outputs per string
- The maximum length of a string is 10 m. If the CP interface is positioned centrally, the CP system can cover an area of 20 m in diameter.
- Modules with CPI functionality

The following CP module variants are available:

- Input modules with 8 or 16 digital inputs (connection technology M8, M12)
- Output modules with 4 or 8 digital outputs (connection technology M12)
- Valve terminals with CP string extension (up to 32 solenoid coils, different valve functions)

CPI modules support the following functions:

- Module-oriented diagnostics
- Module/channel-oriented parameterisation
- Support of all functions by the CPX-FMT
- Module can be positioned anywhere within the string

Several CP interface modules can be combined in one CPX terminal, depending on the address capacity of the bus node.

Example:

- CPX-FB13 (512 I/O)
- Max. 4 CP interface modules (128 I/O each) possible

 **Note**

When arranging the CP modules it should be taken into consideration that CP input modules without CPI functionality should always be placed at the end of a string.

Configuration

The following rules apply for a string of a CPX-CP interface:

- Max. one output module or one valve terminal without CPI functionality
- Max. one output module without CPI functionality or one valve terminal with CP string extension
- Any number of CP modules with CPI functionality, up to the maximum limit of 4 modules and/or 32 inputs/32 outputs per string

- Maximum extension:
- 4 input modules and 4 valve terminals/output modules without CPI functionality
- 16 CP modules with CPI functionality

The configuration of the strings with respect to the module type and position of the modules in the string is entered by activating the SAVE key in the CPX-CP interface and saved there permanently.

Saved data are retained even when the CP interface is isolated from the power supply.

The representation of the CP interface within a CPX terminal and thus at the fieldbus is dependent on the characteristics of the relevant fieldbus system. In addition to input and output addressing, this also applies to the representation of the diagnostics and parameterisation of the CP module and the characteristics of the CPI system.

 **Note**

The remanent saving of configuration data means that changes in the configuration or faulty modules are still displayed even after a voltage failure.

Data sheet – Interface for CPI system

General technical data			
Type	CPX-CP-4-FB		
Brief description	CP interface		
Max. number of	CP strings		4
	CP modules per string		4
	Outputs per string		32
	Inputs per string		32
CP connection	Socket M9, 5-pin		
Baud rate		[kbps]	1000
Cycle time	CP modules without CPI functionality	[ms]	4
	CP modules with CPI functionality	[ms]	2
LED displays	L1 ... 4= Status of the CP string 1 ... 4 PS = Electronics supply, sensor supply PL = Load supply RN = Status of the CP system SF = System fault		
Device-specific diagnostics	Via bus node		
Operating voltage	Nominal value	[V DC]	24 (reverse polarity protected)
	Permissible range	[V DC]	18 ... 30
	Power failure buffering	[ms]	20
Sensor supply voltage		[V DC]	24 ±25% coming from bus node
Actuator load voltage		[V DC]	24 ±10% coming from bus node
Current consumption	Without CP modules	[A]	Max. 0.2
	Per CP string	[A]	Max. 1.6
Degree of protection to EN 60529	IP65, IP67		
Temperature range	Operation	[°C]	-5 ... +50
	Storage/transport	[°C]	-20 ... +70
Materials	PA		
PWIS conformity	VDMA24364-B2-L		
Grid dimension		[mm]	50
Dimensions (including interlinking block) W x L x H		[mm]	50 x 107 x 45
Product weight		[g]	139

 **Note**

Please observe the general limits and guidelines for the system when configuring the electrical modules.

Data sheet – Interface for CPI system

Connection and display components

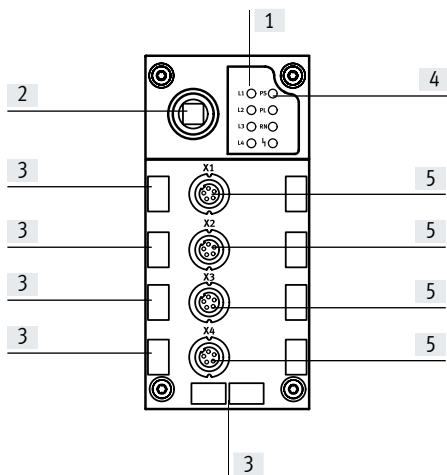

- [1] CP string LEDs
- [2] SAVE key
- [3] Holders for inscription labels (IBS 6x10)
- [4] CPX-specific status LEDs
- [5] CP connections for up to 4 strings (0 ... 3)



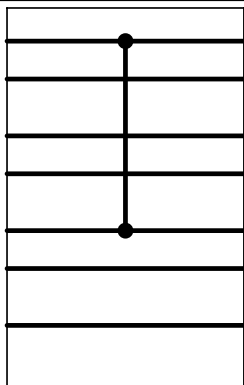

Power supply

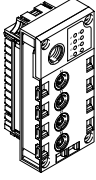

- 0V** Valves
- 24V** Valves
- 0V** Output
- 24V** Output
- 0V** El./Sen.
- 24V** El./Sen.
- FE**

The module combines the 0 V potential of the power supply for electronics and sensors with the 0 V potential of the power supply for valves.
 If all pins of the valves of a pneumatic interface connected to the right of the CP interface are to be switched off, an appropriate interlinking block with additional supply for valves must be used to the right of the CP interface.

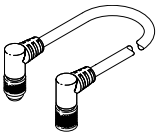
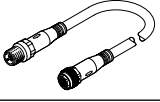
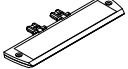
Data sheet – Interface for CPI system

Ordering data		Part no.	Type
Designation			
CP interface			
	Interface for max. 16 I/O modules and valve terminals of the CPI system	526705	CPX-CP-4-FB
Bus connection			
	Cover cap	M12	165592 ISK-M12
	Connecting cable, angled plug, angled socket	0.25 m	540327 KVI-CP-3-WS-WD-0.25
		0.5 m	540328 KVI-CP-3-WS-WD-0.5
		2 m	540329 KVI-CP-3-WS-WD-2
		5 m	540330 KVI-CP-3-WS-WD-5
		8 m	540331 KVI-CP-3-WS-WD-8
	Connecting cable, straight plug, straight socket	2 m	540332 KVI-CP-3-GS-GD-2
		5 m	540333 KVI-CP-3-GS-GD-5
		8 m	540334 KVI-CP-3-GS-GD-8
	Inscription label holder for connection block	536593	CPX-ST-1
User documentation			
	User documentation for CPX-CP interface	German	539293 P.BE-CPX-CP-EN
		English	539294 P.BE-CPX-CP-EN
		Spanish	539295 P.BE-CPX-CP-ES
		French	539296 P.BE-CPX-CP-FR
		Italian	539297 P.BE-CPX-CP-IT

Data sheet – I-Port interface

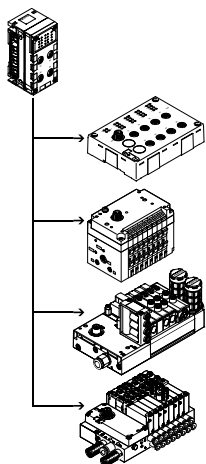

The electrical interface CPX CTEU master establishes the connection to modules of the CTEL/CTEU series that have an I-Port interface (device). The I/O data from the connected devices are transmitted to the connected CPX bus node and thus to the higher-order controller via fieldbus. A maximum of 4 devices can be connected to a CPX CTEU master via corresponding M12 interfaces.



Application

I-Port interface

As well as transmitting the communication data, the I-Port interfaces of a CPX CTEU master also transmit the power supply to the connected sensors and the load supply to the valves (or

outputs). Both circuits are supplied separately with 24 V, using a separate reference potential. The connecting cables with a dual function as signal cable and supply ca-

ble must meet the corresponding increased requirements.

Configuration example – CPX CTEU master with CTEL modules

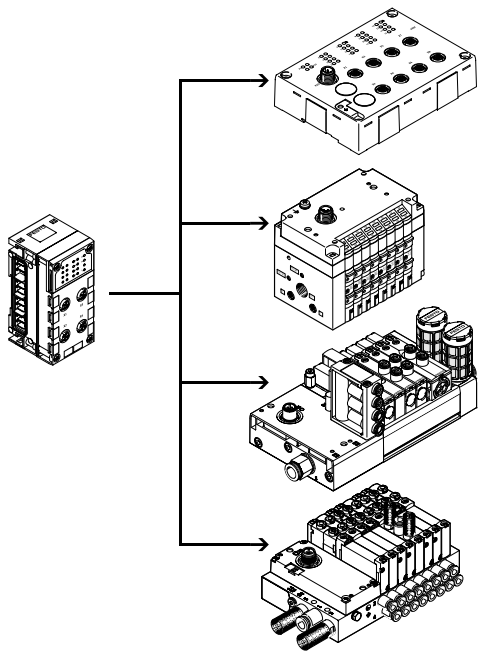

The CPX CTEU master provides 4 external I-Port interfaces, each of which can be connected to a device. I-Port is an interface for exchanging serial data for connecting decentralised modules or valve terminals from Festo. The I-Port interface is based on IO-Link and is compatible with it in certain areas. The connection type corresponds to a star topology. In other words, only one module or valve terminal can be connected to each I-Port.

The limitations with respect to IO-Link include:

- Permanently set baud rate of 230.4 kbps
- SIO mode is not supported
- Max. 32 bytes of input data and 32 bytes of output data
- Only one dump of the master commands is used
- Configuration via IO-DD is not supported.

Data sheet – I-Port interface

Implementation

The CPX CTEL master from Festo enables modules with an I-Port interface to be connected to a CPX system:

- Max. 4 devices with individual electronic protection
- Max. 64 inputs/64 outputs per I-Port interface
- The maximum length of a string is 20 m.

The following device variants are available:

- Input modules with 16 digital inputs (connection technology M8 3-pin and M12 5-pin)
- Valve terminals with I-Port interface (up to 48 solenoid coils, different valve functions)

The decentralised arrangement of the modules and valve terminals with I-Port enables them to be mounted close to the cylinders and actuators or sensors to be controlled. This means that the compressed air supply lines and sensor connecting cables used can be shortened, and it may be possible to use smaller valves, thereby saving costs.

Several CPX CTEL masters can be combined in one CPX terminal, depending on the address capacity of the bus node.

Example:

- CPX-FB13 (512 I/O)
- A maximum of 2 CPX CTEL masters is possible (each with 256 I/O)

Configuration

Settings

The exact amount of the I/O bytes made available depends on the requirements of the connected devices or of the correspondingly selected operating mode.

The operating mode or preset configuration of the CPX CTEL master can be specified by the user.

Selecting the operating mode and setting the manual configuration takes place via the DIL switches. These DIL switches are not required during continuous operation and are only accessible in the disassembled state.

Manual configuration

In the case of manual configuration (tool change mode), the volume of inputs and outputs in the process image of the CPX system or of the higher-order fieldbus can be defined manually using the DIL switches.

The process image then always has the same scope, regardless of the connected devices.

The I/O length specified always applies to all four I-Ports (max. 8 bytes per I-Port).

Automatic configuration

In the case of automatic configuration, the I/O length for each I-Port is determined individually and this value is used to select the appropriate or next highest configuration preset.

Power supply for I-Port devices

The CPX-CTEL master provides two separate power supplies for the connected devices:

- For operating the device and the inputs connected to it
- For the outputs and valves that are connected to the device

The power supply for the devices and the inputs is provided by the power supply for the electronics and sensors of the CPX terminal.

The power supply for the outputs and valves is provided by the power supply for the valves of the CPX terminal.

The interlinking block with additional supply ensures a separate supply voltage for the valves and outputs. This means it is possible to disconnect this supply voltage separately.

The valves and outputs of the connected I-Port devices can therefore be dis-

connected separately without disconnecting the devices.

Data sheet – I-Port interface

General technical data			
Type	CPX-CTEL-4-M12-5POL		
Protocol	I-Port		
Max. address capacity	Outputs	[bit]	256
	Inputs	[bit]	256
I-Port connection	4x socket M12, 5-pin, A-coded		
Number of I-Port interfaces	4		
Maximum cable length	[m]	20	
Internal cycle time	[ms]	1 per 8 bits of user data	
Galvanic isolation	Channel – channel	No	
	Channel – internal bus	Yes, with intermediate supply	
LED displays	X1 ... 4 = Status of the I-Port interface 1 ... 4 PS = Electronic supply PL = Load supply - E - = Module error		
Diagnostics	<ul style="list-style-type: none"> • Communication error • Module short circuit • Module-oriented diagnostics • Undervoltage 		
Parameterisation	<ul style="list-style-type: none"> • Diagnostic behaviour • Failsafe per channel • Forcing per channel • Idle mode per channel • Module parameters • Tool change mode 		
Additional functions	Tool change mode		
Control elements	DIL switch		
Operating voltage	Nominal value	[V DC]	24 (reverse polarity protected)
	Permissible range	[V DC]	18 ... 30
	Power failure buffering	[ms]	10
Intrinsic current consumption at nominal operating voltage	[mA]	Typically 65	
Max. power supply per channel	[A]	4x 1.6	
Max. residual current of outputs per channel	[A]	4x 1.6	
Degree of protection to EN 60529	IP65, IP67		
Temperature range	Operation	[°C]	-5 ... +50
	Storage/transport	[°C]	-20 ... +70
Materials	Reinforced PA, PC		
Note on materials	RoHS-compliant		
PWIS conformity	VDMA24364-B2-L		
Grid dimension	[mm]	50	
Dimensions (including interlinking block) W x L x H	[mm]	50 x 107 x 55	
Product weight	[g]	110	

 **Note**

Please observe the general limits and guidelines for the system when configuring the electrical modules.

Data sheet – I-Port interface

Connection and display components

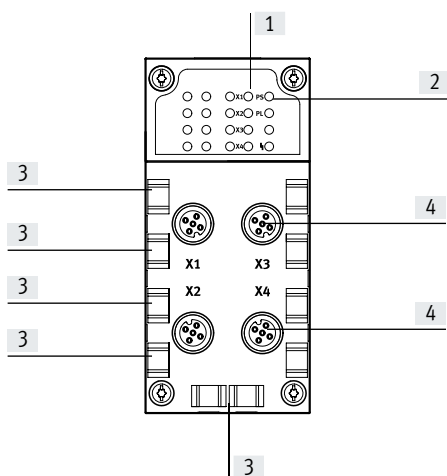

- [1] Status LEDs for I-Port interfaces
- [2] CPX-specific status LEDs
- [3] Holders for inscription labels (IBS 6x10)
- [4] I-Port interfaces for up to 4 devices

Combinations of bus nodes/control blocks with interface CPX-CTEL

Bus node/control block	Part no.	Interface
		CPX-CTEL-4-M12-5POL
CPX-CEC-C1	567347	■
CPX-CEC-C1-V3	3473128	■
CPX-CEC-M1-V3	3472765	■
CPX-CEC	567346	■
CPX-CEC-S1-V3	3472425	■
CPX-FB11	526172	■
CPX-FB13	195740	■
CPX-FB14	526174	■
CPX-FB23-24	526176	■
CPX-FB36	1912451	■
CPX-FB37	2735960	■
CPX-FB39	2093101	■
CPX-FB40	2474896	■
CPX-FB43	8110369	■
CPX-M-FB44	8110370	■
CPX-M-FB45	8110371	■

Pin allocation – I-Port interface

Terminal allocation	Pin	Signal	Designation
	1	24 V _{SEN}	24 V DC supply voltage for electronics and inputs
	2	24 V _{VAL}	24 V DC load voltage supply for valves and outputs
	3	0 V _{SEN}	0 V DC supply voltage for electronics and sensors
	4	C/Q _{I-Port}	Communication signal C/Q, data transmission line
	5	0 V _{VALVES}	0 V DC load voltage supply for valves and outputs

Data sheet – I-Port interface

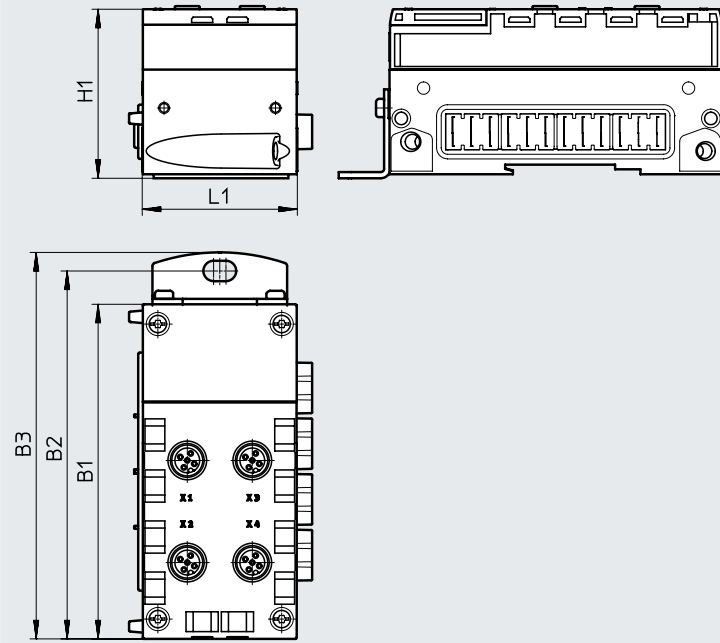

Dimensions

Download CAD data → www.festo.com

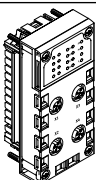

Type	B1	B2	B3	H1	L1
CPX-CTEL-4-M12-5POL	108.1	118.9	124.9	55.1	50

Data sheet – I-Port interface

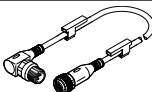
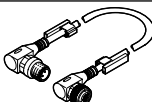
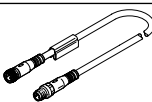
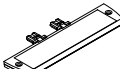
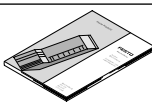
Ordering data		Part no.	Type
Designation			
CPX-CTEL master			
	Interface for a maximum of 4 I/O modules and valve terminals with I-Port interface (devices)	1577012	CPX-CTEL-4-M12-5POL
Bus connection			
	Cover cap	M12	165592 ISK-M12
	Connecting cable M12-M12, 5-pin • Straight socket • Angled plug	Cable characteristic: standard	0.5 m 8003617 NEBU-M12G5-K-0.5-M12W5
			2 m 8003618 NEBU-M12G5-K-2-M12W5
	Connecting cable M12-M12, 5-pin • Angled socket • Angled plug	Cable characteristic: standard	0.5 m 570733 NEBU-M12W5-K-0.5-M12W5
			2 m 570734 NEBU-M12W5-K-2-M12W5
	Connecting cable M12-M12, 5-pin • Straight socket • Straight plug	Cable characteristic: suitable for use with energy chains	5 m 574321 NEBU-M12G5-E-5-Q8N-M12G5
			7.5 m 574322 NEBU-M12G5-E-7.5-Q8N-M12G5
			10 m 574323 NEBU-M12G5-E-10-Q8N-M12G5
	Inscription label holder for connection block		536593 CPX-ST-1
User documentation			
	User documentation CPX-CTEL master	German	574600 P.BE-CPX-CTEL-DE
		English	574601 P.BE-CPX-CTEL-EN
		Spanish	574602 P.BE-CPX-CTEL-ES
		French	574603 P.BE-CPX-CTEL-FR
		Italian	574604 P.BE-CPX-CTEL-IT

Data sheet – IO-Link interface

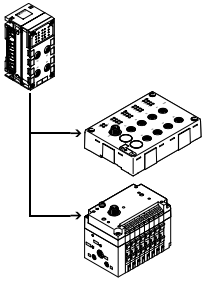

The electrical interface CPX-CTEL-2-... enables the connection of modules with IO-Link interface (IO-Link device) to the CPX terminal. The I/O data from the connected devices are transmitted to the connected CPX bus node and thus to the higher-order controller via fieldbus.

A maximum of two IO-Link devices can be connected to an electrical interface CPX-CTEL-2-... via the corresponding M12 interfaces.



Application

The communication system IO-Link is used to exchange serial data from decentralised function modules (devices) at the field level.

The electrical interface CPX-CTEL-2-... provides two external IO-Link interfaces,

each of which can be connected to a device.

The connection type corresponds to a star topology, which means that only one device can be connected to each port.

The address space that the module makes available and assigns accordingly in the CPX system can be configured according to various presettings. Selecting the operating mode and setting the manual configuration takes place via the DIL switches.

These DIL switches are not required during continuous operation and are only accessible in the disassembled state.

Restrictions

The interfaces (ports) of electrical interface CPX-CTEL-2-... support the connection of IO-Link devices with few limitations.

- The process data length of the inputs and outputs is limited to 16 bytes each per port

- The driver strength on the C/Q line is limited to 250 mA

- SIO mode is not supported

Power supply for devices

The electrical interface CPX-CTEL-2-... provides two separate power supplies for the connected devices:

- For operating the device and the inputs connected to it
- For the outputs and valves that are connected to the device

The power supply for the devices and the inputs is provided by the power

supply for the electronics and sensors of the CPX terminal.

The power supply for the outputs and valves is provided by the power supply for the valves of the CPX terminal.

The interlinking block with additional supply ensures a separate supply voltage for the valves and outputs. This

means it is possible to disconnect this supply voltage separately.

The valves and outputs of the connected I-Port devices can therefore be disconnected separately without disconnecting the devices.

Data sheet – IO-Link interface

General technical data			
Type	CPX-CTEL-2-M12-5POL-LK		
Protocol	IO-Link, master version V 1.0		
Max. address capacity	Outputs	[bit]	256
	Inputs	[bit]	256
I-Port connection	2x socket M12, 5-pin, A-coded		
Number of IO-Link interfaces	2		
Maximum cable length	[m]	20	
Internal cycle time	[ms]	1 per 8 bits of user data	
Galvanic isolation	Channel – channel	No	
	Channel – internal bus	Yes, with intermediate supply	
LED displays	X1 ... 2 = Status of the IO-Link interface 1 ... 2 PS = Electronic supply PL = Load supply  = Module error		
Diagnostics	<ul style="list-style-type: none"> • Communication error • Module short circuit • Module-oriented diagnostics • Undervoltage 		
Parameterisation	<ul style="list-style-type: none"> • Diagnostic behaviour • Failsafe per channel • Forcing per channel • Idle mode per channel • Module parameters 		
Additional functions	–		
Control elements	DIL switch		
Operating voltage	Nominal value	[V DC]	24 (reverse polarity protected)
	Permissible range	[V DC]	18 ... 30
	Power failure buffering	[ms]	10
Intrinsic current consumption at nominal operating voltage	[mA]	Typically 65	
Max. power supply per channel	[A]	2x 1.6	
Max. residual current of outputs per channel	[A]	2x 1.6	
Degree of protection to EN 60529	IP65, IP67		
Temperature range	Operation	[°C]	–5 ... +50
	Storage/transport	[°C]	–20 ... +70
Materials	Reinforced PA, PC		
Note on materials	RoHS-compliant		
PWIS conformity	VDMA24364-B2-L		
Grid dimension	[mm]	50	
Dimensions (including interlinking block) W x L x H	[mm]	50 x 107 x 55	
Product weight	[g]	110	

**Note**

Please observe the general limits and guidelines for the system when configuring the electrical modules.

Data sheet – IO-Link interface

Connection and display components

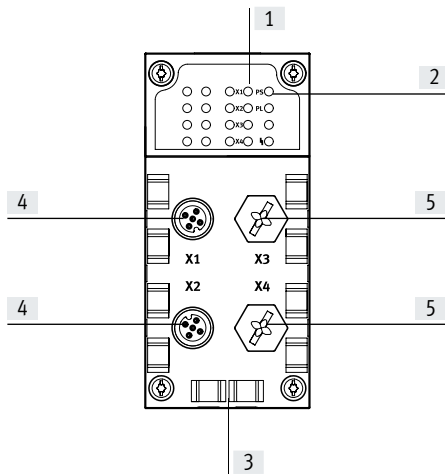

- [1] Status LEDs for I-Port interfaces
- [2] CPX-specific status LEDs
- [3] Holders for inscription labels (IBS 6x10)
- [4] IO-Link interfaces for up to 2 devices
- [5] Unused connections

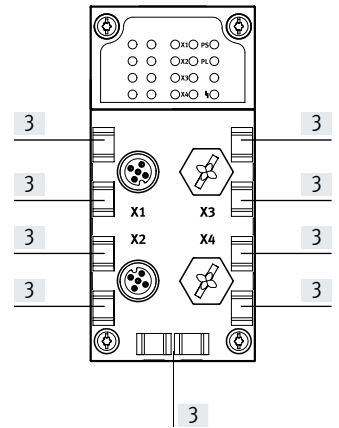

Combinations of bus nodes/control blocks with interface CPX-CTEL-2

Bus node/control block	Part no.	Interface
		CPX-CTEL-2-M12-5POL-LK
CPX-CEC-C1-V3	3473128	■
CPX-CEC-M1-V3	3472765	■
CPX-CEC-S1-V3	3472425	■
CPX-FB36	1912451	■
CPX-FB39	2093101	■
CPX-FB43	8110369	■
CPX-M-FB44	8110370	■
CPX-M-FB45	8110371	■

Pin allocation of IO-Link interface

Terminal allocation	Pin	Signal	Designation
	1	24 V _{SEN}	24 V DC supply voltage for electronics and inputs
	2	24 V _{VAL}	24 V DC load voltage supply for valves and outputs
	3	0 V _{SEN}	0 V DC supply voltage for electronics and sensors
	4	C/Q _{I-Port}	Communication signal C/Q, data transmission line
	5	0 V _{VALVES}	0 V DC load voltage supply for valves and outputs



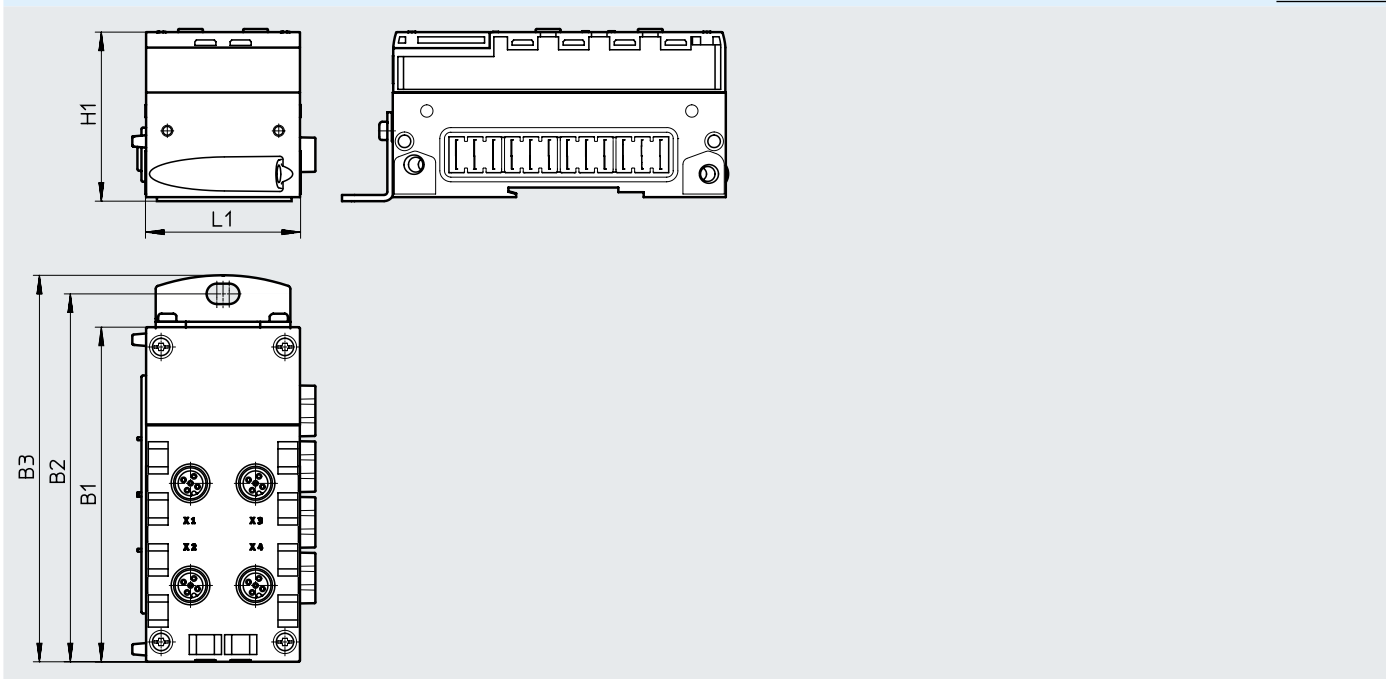

Data sheet – IO-Link interface

Dimensions

Download CAD data → www.festo.com

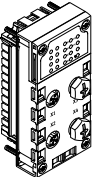
Type	B1	B2	B3	H1	L1
CPX-CTEL-2-M12-5POL-LK	108.1	118.9	124.9	55.1	50

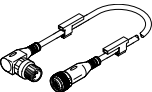
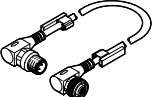
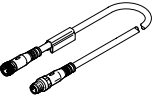
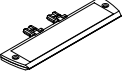
Data sheet – IO-Link interface

Ordering data		Part no.	Type
Designation			
CPX CTEL master, IO-Link			
	Interface for max. 2 I/O modules and valve terminals with IO-Link interface (devices)	2900543	CPX-CTEL-2-M12-5POL-LK
Bus connection			
	Cover cap	M12	165592 ISK-M12
	Connecting cable M12-M12, 5-pin • Straight socket • Angled plug	Cable characteristic: standard	0.5 m 8003617 NEBU-M12G5-K-0.5-M12W5
			2 m 8003618 NEBU-M12G5-K-2-M12W5
	Connecting cable M12-M12, 5-pin • Angled socket • Angled plug	Cable characteristic: standard	0.5 m 570733 NEBU-M12W5-K-0.5-M12W5
			2 m 570734 NEBU-M12W5-K-2-M12W5
	Connecting cable M12-M12, 5-pin • Straight socket • Straight plug	Cable characteristic: suitable for use with energy chains	5 m 574321 NEBU-M12G5-E-5-Q8N-M12G5
			7.5 m 574322 NEBU-M12G5-E-7.5-Q8N-M12G5
			10 m 574323 NEBU-M12G5-E-10-Q8N-M12G5
	Inscription label holder for connection block		536593 CPX-ST-1
User documentation			
	User documentation CPX CTEL master	German	8034115 P.BE-CPX-CTEL-LK-DE
		English	8034116 P.BE-CPX-CTEL-LK-EN
		Spanish	8034117 P.BE-CPX-CTEL-LK-ES
		French	8034118 P.BE-CPX-CTEL-LK-FR
		Italian	8034119 P.BE-CPX-CTEL-LK-IT
		Swedish	8034120 P.BE-CPX-CTEL-LK-ZH

Data sheet – Axis controller for 4 electric axes

The control block CPX-CM-HPP is a module in the CPX terminal for controlling electric drives.

The control component is independent of the bus node used.

This means that Festo's electric drive technology is compatible with all industrial communication interfaces.

The control block does not need to be programmed.

- Max. 4 individual electric axes can be controlled via CAN bus
- No programming required
- Standardised communication with the drives via the Festo Handling and Positioning Profile (FHPP)
- Quick configuration and diagnostics via CPX-FMT
- Simple, flexible and cost-effective



General technical data		
Fieldbus interface		1x socket M9, 5-pin
Protocol		FHPP
Max. address capacity inputs	[byte]	32
Max. address volume for outputs	[byte]	32
LED display (product-specific)		Error: Fault PL: Power supply
Device-specific diagnostics		Diagnostic memory Channel and module-oriented diagnostics Undervoltage/short circuit of modules
Parameterisation		Forcing of channels System parameters
Configuration support		Operator unit CPX-MMI
Total number of axes		4
Nominal operating voltage	[V DC]	24
Operating voltage range	[V DC]	18 ... 30
Power failure buffering	[ms]	10
Intrinsic current consumption at nominal operating voltage	[mA]	Typically 80
Degree of protection to EN 60529 (with plug inserted)		IP65/IP67
Dimensions W x L x H (including interlinking block)	[mm]	50 x 107 x 55
Product weight (without interlinking block)	[g]	140
Materials		
Housing		PA-reinforced PC
Note on materials		RoHS-compliant
PWIS conformity		VDMA24364-B2-L
Technical data – Interfaces		
Interface		
Control interface		CAN bus
Baud rate	[Mbps]	1
Operating and environmental conditions		
Ambient temperature	[°C]	-5 ... +50
Storage temperature	[°C]	-20 ... +70
CE marking (see declaration of conformity)		To EU Low Voltage Directive

Data sheet – Axis controller for 4 electric axes

Connection and display components

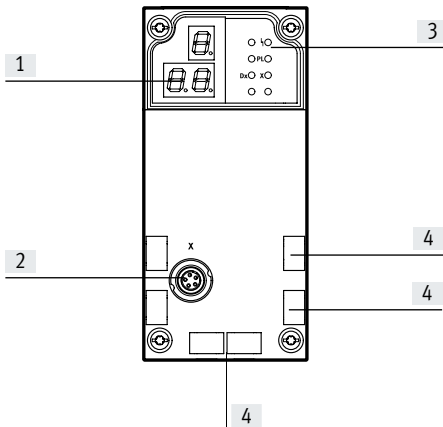

- [1] 3-digit display
- [2] Control interface
- [3] LED display (product-specific)
- [4] Inscription labels



Pin allocation – Control interface

	Pin	Signal	Meaning
Socket M9, 5-pin			
	1	n.c.	Not connected
	2	n.c.	Not connected
	3	CAN_GND	CAN ground
	4	CAN_H	CAN high
	5	CAN_L	CAN low
	Housing	Shielding	Cable shield must be connected to functional earth (FE)

Permitted bus nodes/CEC

Bus node/CEC	Protocol	Max. number of CPX-CM-HPP modules
CPX-CEC...	–	0
CPX-FB11	DeviceNet	2
CPX-FB13	PROFIBUS	2
CPX-FB14	CANopen	1
CPX-FB23-24	CC-Link	1 (as function module F23)
		0 (as function module F24)
CPX-FB36	EtherNet/IP	2
CPX-FB37	EtherCAT	2
CPX-FB39	Sercos III	2
CPX-FB40	POWERLINK	2
CPX-FB43	PROFINET RT, M12	2
CPX-M-FB44	PROFINET RT, RJ45	2
CPX-M-FB45	PROFINET RT, SCRJ	2

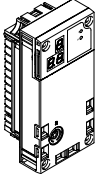
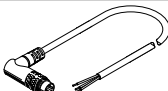
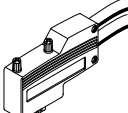
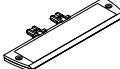
Data sheet – Axis controller for 4 electric axes

Ordering data – Bus connection				
Designation			Part no.	Type
Control block				
	For actuating up to 4 electric drives via CAN bus		562214	CPX-CM-HPP
Connecting cable				
	Connecting cable	2 m	563711	NEBC-M9W5-K-2-N-LE3
		5 m	563712	NEBC-M9W5-K-5-N-LE3
	Plug for CAN bus interface; Sub-D, 9-pin, without terminating resistor		533783	FBS-SUB-9-WS-CO-K
Inscription labels				
	Inscription label holder for connection block		536593	CPX-ST-1
User documentation				
	Manual – Control block CPX-CM-HPP	German	568683	CPX-CM-HPP-DE
		English	568684	CPX-CM-HPP-EN

Data sheet – Axis controller for 1 electric axis

The axis controller CPX-CMAX is intended exclusively for use in valve terminals CPX.

General technical data
Operating voltage

Operating voltage range	[V DC]	18 ... 30
Nominal operating voltage	[V DC]	24
Current consumption at nominal operating voltage	[mA]	200
Fuse protection (short circuit)		Electronic
Power failure buffering	[ms]	10

Load voltage

Load voltage range	[V DC]	20 ... 30
Nominal load voltage	[V DC]	24
Permissible load current	[A]	2.5
Fuse protection (short circuit)		Electronic

Number of axis strings		1	
Axes per string		1	
Length of connecting cable to axis	[m]	≤ 30	
Max. number of modules		7	
Display		7-segment display	
Assigned addresses	Outputs	[bit]	8x8
	Inputs	[bit]	8x8
Operating modes		Record mode	
		Direct mode	
Controller types		Position control	
		Force control	
Diagnostics		Module-orientated	
		Via local 7-segment display	
Status indication		Module status	
		Power load	
		Display/Error Axis X	
		MC Axis X	

Control interface

Data		CAN bus with Festo protocol
		Digital
Electrical connection		5-pin
		M9
		Socket

Materials: Housing		PA-reinforced	
Note on materials		RoHS-compliant	
PWIS conformity		VDMA24364-B2-L	
Product weight	[g]	240	
Dimensions	Length	[mm]	107
	Width	[mm]	50
	Height	[mm]	55

Data sheet – Axis controller for 1 electric axis

Operating and environmental conditions		
Ambient temperature	[°C]	-5 ... +50
Relative humidity	[%]	5 ... 95, non-condensing
Degree of protection to IEC 60529		IP65

Connection and display components

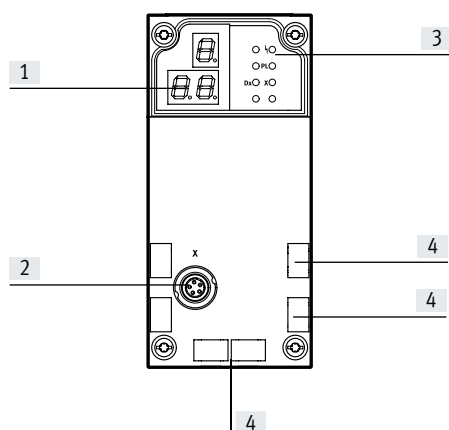

- [1] 3-digit display
- [2] Control interface
- [3] Status LEDs
- [4] Inscription labels

Pin allocation – Control interface



	Pin	Signal	Designation
	1	+24 V	Nominal operating voltage
	2	+24 V	Load voltage
	3	0 V	Ground
	4	CAN_H	CAN high
	5	CAN_L	CAN low
	Housing	Shielding	Cable shielding

Permitted bus nodes/CEC		
Bus node/CEC	Protocol	Max. number of CMAX modules
CPX-CEC...	-	8
CPX-FB11	DeviceNet ¹⁾	8
CPX-FB13	PROFIBUS ²⁾	8
CPX-FB14	CANopen	4
CPX-FB23-24	CC-Link	4 (as function module F23)
		8 (as function module F24)
CPX-FB36	EtherNet/IP	8
CPX-FB37	EtherCAT	8
CPX-FB39	Sercos III	8
CPX-FB40	POWERLINK	8
CPX-FB43	PROFINET RT, M12	8
CPX-M-FB44	PROFINET RT, RJ45	8
CPX-M-FB45	PROFINET RT, SCRJ	8

1) As of revision 20 (R20)

2) As of revision 23 (R23)

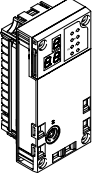
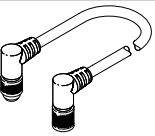
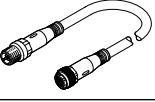
Data sheet – Axis controller for 1 electric axis

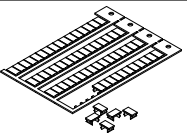
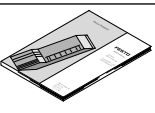
Ordering data		Brief description	Part no.	Type
Axis controller				
	Order code in the CPX configurator: T21		548932	CPX-CMAX-C1-1
Connecting cables				
	Connecting cable with angled plug and angled socket	0.25 m	540327	KVI-CP-3-WS-WD-0.25
		0.5 m	540328	KVI-CP-3-WS-WD-0.5
		2 m	540329	KVI-CP-3-WS-WD-2
		5 m	540330	KVI-CP-3-WS-WD-5
		8 m	540331	KVI-CP-3-WS-WD-8
	Connecting cable with straight plug and straight socket	2 m	540332	KVI-CP-3-GS-GD-2
		5 m	540333	KVI-CP-3-GS-GD-5
		8 m	540334	KVI-CP-3-GS-GD-8
	Connecting component for cabinet through feed		543252	KVI-CP-3-SSD
Screws				
	For mounting on the metal interlinking block		550219	CPX-M-M3X22-4X
Inscription labels				
	Inscription labels 6x10, in frames	64 pieces	18576	IBS-6x10
User documentation				
	Manual – Axis controller CPX-CMAX ¹⁾	German	559750	P.BE-CPX-CMAX-SYS-DE
		English	559751	P.BE-CPX-CMAX-SYS-EN
		Spanish	559752	P.BE-CPX-CMAX-SYS-ES
		French	559753	P.BE-CPX-CMAX-SYS-FR
		Italian	559754	P.BE-CPX-CMAX-SYS-IT

1) User documentation in paper form is not included in the scope of delivery.

Data sheet – End-position controller

The end-position controller CPX-CMPX is intended exclusively for use in valve terminals CPX.



General technical data			
Operating voltage			
Operating voltage range	[V DC]	18 ... 30	
Nominal operating voltage	[V DC]	24	
Current consumption at nominal operating voltage	[mA]	80	
Load voltage			
Load voltage range	[V DC]	20 ... 30	
Nominal load voltage	[V DC]	24	
Permissible load current	[A]	2.5	
Number of axes per module		1	
Length of connecting cable to axis	[m]	≤ 30	
Max. number of modules		9	
Display		7-segment display	
Control elements		3 buttons	
Assigned addresses	Outputs	[bit]	6x8
	Inputs	[bit]	6x8
Diagnostics		Module-orientated	
		Via local 7-segment display	
Status indication		Module status	
		Power load	
Control interface			
Data		CAN bus with Festo protocol	
		Digital	
Electrical connection		5-pin	
		M9	
		Socket	
Materials: Housing		PA-reinforced	
PWIS conformity		VDMA24364-B2-L	
Product weight	[g]	140	
Dimensions	Length	[mm]	107
	Width	[mm]	50
	Height	[mm]	55

Data sheet – End-position controller

Operating and environmental conditions

Ambient temperature	[°C]	-5 ... +50
Relative humidity	[%]	5 ... 95, non-condensing
Degree of protection to IEC 60529		IP65
CE marking (see declaration of conformity)		To EU EMC Directive

Connection and display components

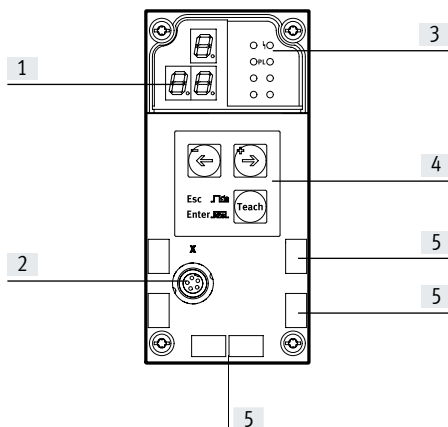

- [1] 3-digit display
- [2] Control interface
- [3] Status LEDs
- [4] Operating buttons
- [5] Inscription labels

Pin allocation – Control interface

	Pin	Signal	Designation
	1	+24 V	Nominal operating voltage
	2	+24 V	Load voltage
	3	0 V	Ground
	4	CAN_H	CAN high
	5	CAN_L	CAN low
	Housing	Shielding	Cable shielding



Permitted bus nodes/CEC

Bus node/CEC	Protocol	Max. no. of CMPX modules
CPX-CEC...	-	9
CPX-FB11	DeviceNet ¹⁾	9
CPX-FB13	PROFIBUS ²⁾	9
CPX-FB14	CANopen	5
CPX-FB23-24	CC-Link	5 (as function module F23)
		9 (as function module F24)
CPX-FB36	EtherNet/IP	9
CPX-FB37	EtherCAT	9
CPX-FB39	Sercos III	9
CPX-FB40	POWERLINK	9
CPX-FB43	PROFINET RT, M12	9
CPX-M-FB44	PROFINET RT, RJ45	9
CPX-M-FB45	PROFINET RT, SCRJ	9

1) As of revision 20 (R20)

2) As of revision 23 (R23)

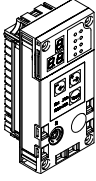
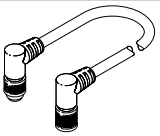
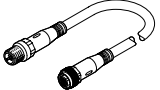
Data sheet – End-position controller

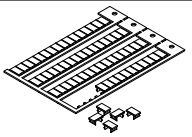
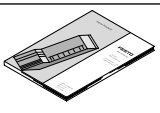
Ordering data		Brief description	Part no.	Type
End-position controller				
	Order code in the CPX configurator: T20		548931	CPX-CMPX-C-1-H1
Connecting cables				
	Connecting cable with angled plug and angled socket	0.25 m	540327	KVI-CP-3-WS-WD-0.25
		0.5 m	540328	KVI-CP-3-WS-WD-0.5
		2 m	540329	KVI-CP-3-WS-WD-2
		5 m	540330	KVI-CP-3-WS-WD-5
		8 m	540331	KVI-CP-3-WS-WD-8
	Connecting cable with straight plug and straight socket	2 m	540332	KVI-CP-3-GS-GD-2
		5 m	540333	KVI-CP-3-GS-GD-5
		8 m	540334	KVI-CP-3-GS-GD-8
	Connecting component for cabinet through feed		543252	KVI-CP-3-SSD
Screws				
	For mounting on the metal interlinking block		550219	CPX-M-M3X22-4X
Inscription labels				
	Inscription labels 6x10, in frames	64 pieces	18576	IBS-6x10
User documentation				
	Manual – End-position controller CPX-CMPX ¹⁾	German	555479	P.BE-CPX-CMPX-SYS-DE
		English	555480	P.BE-CPX-CMPX-SYS-EN
		Spanish	555481	P.BE-CPX-CMPX-SYS-ES
		French	555482	P.BE-CPX-CMPX-SYS-FR
		Italian	555483	P.BE-CPX-CMPX-SYS-IT

1) User documentation in paper form is not included in the scope of delivery.

Data sheet – Measuring module for displacement encoder

The measuring module CPX-CMIX is intended exclusively for use in valve terminals CPX.

General technical data
Operating voltage

Operating voltage range	[V DC]	18 ... 30
Nominal operating voltage	[V DC]	24
Current consumption at nominal operating voltage	[mA]	80
Short circuit current rating		Yes
Power failure buffering	[ms]	10

Number of axis strings		1
Axes per string		1
Length of connecting cable to axis	[m]	≤ 30
Max. number of modules		9

Display		7-segment display	
Assigned addresses	Outputs	[bit]	6x8
	Inputs	[bit]	6x8
Diagnostics			Channel and module-oriented
			Via local 7-segment display
			Undervoltage of modules
			Undervoltage of measuring system
Status indication			Power load
			Error

Control interface

Data		CAN bus with Festo protocol
		Digital
Electrical connection		5-pin
		M9
		Socket

Materials: Housing		PA-reinforced	
Note on materials		RoHS-compliant	
PWIS conformity		VDMA24364-B2-L	
Product weight	[g]	140	
Dimensions	Length	[mm]	107
	Width	[mm]	50
	Height	[mm]	55

Data sheet – Measuring module for displacement encoder

Operating and environmental conditions		
Ambient temperature	[°C]	-5 ... +50
Storage temperature	[°C]	-20 ... +70
Relative humidity	[%]	5 ... 95, non-condensing
Degree of protection to IEC 60529		IP65

Connection and display components

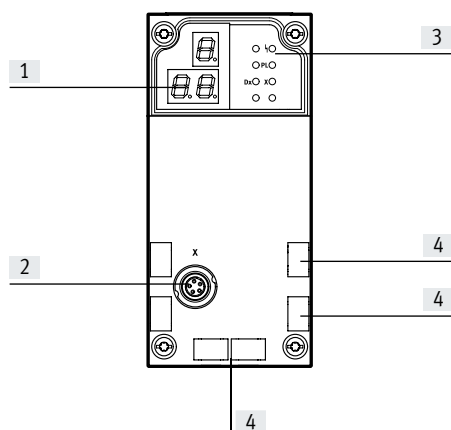

- [1] 3-digit display
- [2] Control interface
- [3] Status LEDs
- [4] Inscription labels

Pin allocation – Control interface

	Pin	Signal	Designation
	1	+24 V	Nominal operating voltage
	2	+24 V	Load voltage
	3	0 V	Ground
	4	CAN_H	CAN high
	5	CAN_L	CAN low
	Housing	Shielding	Cable shielding



Permitted bus nodes/CEC

Bus node/CEC	Protocol	Max. number of CMIX modules
CPX-CEC...	-	9
CPX-FB11	DeviceNet ¹⁾	9
CPX-FB13	PROFIBUS ²⁾	9
CPX-FB14	CANopen	5
CPX-FB23-24	CC-Link	5 (as function module F23)
		9 (as function module F24)
CPX-FB36	EtherNet/IP	9
CPX-FB37	EtherCAT	9
CPX-FB39	Sercos III	9
CPX-FB40	POWERLINK	9
CPX-FB43	PROFINET RT, M12	9
CPX-M-FB44	PROFINET RT, RJ45	9
CPX-M-FB45	PROFINET RT, SCRJ	9

1) As of revision 20 (R20)

2) As of revision 23 (R23)

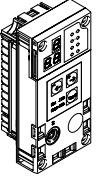
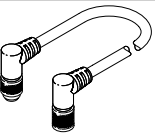
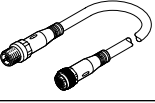
Data sheet – Measuring module for displacement encoder

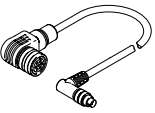
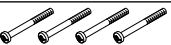
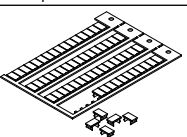
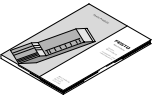
Ordering data		Brief description	Part no.	Type
Measuring module				
	Order code in the CPX configurator: T23		567417	CPX-CMIX-M1-1
Connecting cables				
	Connecting cable with angled plug and angled socket	0.25 m	540327	KVI-CP-3-WS-WD-0.25
		0.5 m	540328	KVI-CP-3-WS-WD-0.5
		2 m	540329	KVI-CP-3-WS-WD-2
		5 m	540330	KVI-CP-3-WS-WD-5
		8 m	540331	KVI-CP-3-WS-WD-8
	Connecting cable with straight plug and straight socket	2 m	540332	KVI-CP-3-GS-GD-2
		5 m	540333	KVI-CP-3-GS-GD-5
		8 m	540334	KVI-CP-3-GS-GD-8
	Connecting component for cabinet through feed		543252	KVI-CP-3-SSD
	For displacement encoder MME: Connection between displacement encoder MME and measuring module CPX-CMIX	2 m	575898	NEBP-M16W6-K-2-M9W5
Screws				
	For mounting on the metal interlinking block		550219	CPX-M-M3X22-4X
Inscription labels				
	Inscription labels 6x10, in frames	64 pieces	18576	IBS-6x10
User documentation				
	Manual – Measuring module CPX-CMIX ¹⁾	German	567053	P.BE-CPX-CMIX-DE
		English	567054	P.BE-CPX-CMIX-EN
		Spanish	567055	P.BE-CPX-CMIX-ES
		French	567056	P.BE-CPX-CMIX-FR
		Italian	567057	P.BE-CPX-CMIX-IT

1) User documentation in paper form is not included in the scope of delivery.

Data sheet – Input module, digital

Function

Digital input modules enable the connection of two-wire and three-wire sensors (proximity switches, inductive or capacitive sensors, etc.).

Depending on the connection block selected, the module supports various connection concepts with different numbers of sockets (single or double allocation).

Area of application

- Input modules for 24 V DC sensor supply voltage
- PNP or NPN logic
- Supports connection blocks with M12, M8, Sub-D and terminal connection
- Module features can be parameterised
- The input module receives the supply voltage for the electronics and the sensors from the interlinking block
- Module protection and diagnostics through integrated electronic protection

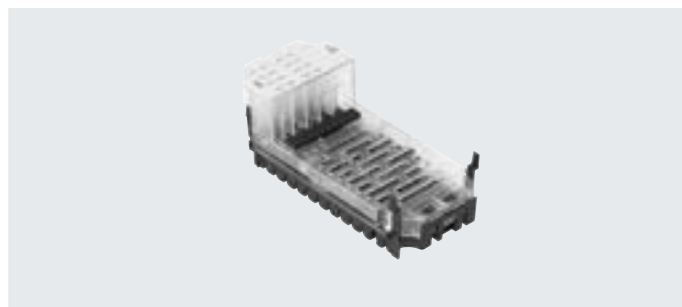

General technical data			CPX-4DE	CPX-8DE	CPX-8DE-D	CPX-8NDE
Type						
Number of inputs			4	8	8	8
Max. residual current of inputs per module		[A]	0.7	1	0.7	0.7
Fuse protection			Internal electronic fuse per module	Internal electronic fuse per module	Internal electronic fuse per channel	Internal electronic fuse per module
Intrinsic current consumption at operating voltage		[mA]	Typically 15			
Operating voltage	Nominal value	[V DC]	24			
	Permissible range	[V DC]	18 ... 30			
Galvanic isolation	Channel – channel		No			
	Channel – internal bus		No			
Switching level	Signal 0	[V DC]	≤ 5			≥ 11
	Signal 1	[V DC]	≥ 11			≤ 5
Input debounce time		[ms]	3 (0.1, 10, 20 parameterisable)			
Input characteristic			IEC 1131-T2			
Switching logic			Positive logic (PNP)			Negative logic (NPN)
LED displays	Group diagnostics		1	1	1	1
	Channel diagnostics		–	–	8	–
	Channel status		4	8	8	8
Diagnostics			Short circuit/overload per channel			
Parameterisation			<ul style="list-style-type: none"> • Module monitoring • Behaviour after short circuit • Input debounce time • Signal extension time 			
Degree of protection to EN 60529			Depending on connection block			
Temperature range	Operation	[°C]	–5 ... +50			
	Storage/transport	[°C]	–20 ... +70			
Materials			Reinforced PA, PC			
PWIS conformity			VDMA24364-B2-L			
Grid dimension		[mm]	50			
Dimensions (including interlinking block and connection block) W x L x H		[mm]	50 x 107 x 50			
Product weight		[g]	39	39	45	40

Data sheet – Input module, digital

Connection and display components

CPX-4DE

CPX-8DE

CPX-8DE-D

CPX-8NDE

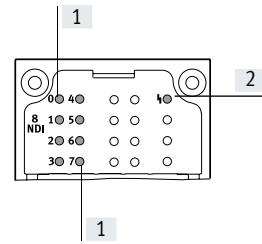
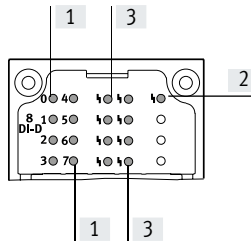
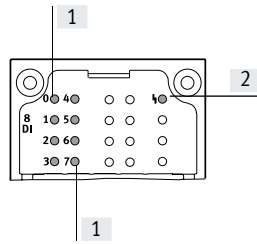
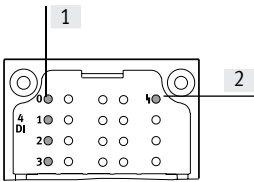

[1] Status LEDs (green)

[2] Error LED (red, module error)

[3] Channel-related error LEDs (red)

For allocation to inputs
→ Pin allocation for module

Combinations of connection blocks and digital input modules

Connection blocks	Part no.	Digital input modules			
		CPX-4DE	CPX-8DE	CPX-8DE-D	CPX-8NDE
CPX-AB-8-M8-3POL	195706	■	■	■	■
CPX-AB-4-M12X2-5POL	195704	■	■	■	■
CPX-AB-4-M12X2-5POL-R	541254	■	■	■	■
CPX-AB-8-KL-4POL	195708	■	■	■	■
CPX-AB-1-SUB-BU-25POL	525676	■	■	■	■
CPX-M-AB-4-M12X2-5POL	549367	■	■	■	■

Pin allocation



Connection block inputs	CPX-4DE	CPX-8DE, CPX-8DE-D and CPX-8NDE		
CPX-AB-8-M8-3POL				
	X1.1: 24 V _{SEN} X1.3: 0 V _{SEN} X1.4: Input x X2.1: 24 V _{SEN} X2.3: 0 V _{SEN} X2.4: Input x+1 X3.1: 24 V _{SEN} X3.3: 0 V _{SEN} X3.4: Input x+1 X4.1: 24 V _{SEN} X4.3: 0 V _{SEN} X4.4: n.c.	X5.1: 24 V _{SEN} X5.3: 0 V _{SEN} X5.4: Input x+2 X6.1: 24 V _{SEN} X6.3: 0 V _{SEN} X6.4: Input x+3 X7.1: 24 V _{SEN} X7.3: 0 V _{SEN} X7.4: Input x+3 X8.1: 24 V _{SEN} X8.3: 0 V _{SEN} X8.4: n.c.	X1.1: 24 V _{SEN x} X1.3: 0 V _{SEN x} X1.4: Input x X2.1: 24 V _{SEN x+1} X2.3: 0 V _{SEN x+1} X2.4: Input x+1 X3.1: 24 V _{SEN x+2} X3.3: 0 V _{SEN x+2} X3.4: Input x+2 X4.1: 24 V _{SEN x+3} X4.3: 0 V _{SEN x+3} X4.4: Input x+3	X5.1: 24 V _{SEN x+4} X5.3: 0 V _{SEN x+4} X5.4: Input x+4 X6.1: 24 V _{SEN x+5} X6.3: 0 V _{SEN x+5} X6.4: Input x+5 X7.1: 24 V _{SEN x+6} X7.3: 0 V _{SEN x+6} X7.4: Input x+6 X8.1: 24 V _{SEN x+7} X8.3: 0 V _{SEN x+7} X8.4: Input x+7
CPX-AB-4-M12X2-5POL, CPX-AB-4-M12X2-5POL-R¹⁾ and CPX-M-AB-4-M12X2-5POL				
	X1.1: 24 V _{SEN} X1.2: Input x+1 X1.3: 0 V _{SEN} X1.4: Input x X1.5: FE X2.1: 24 V _{SEN} X2.2: n.c. X2.3: 0 V _{SEN} X2.4: Input x+1 X2.5: FE	X3.1: 24 V _{SEN} X3.2: Input x+3 X3.3: 0 V _{SEN} X3.4: Input x+2 X3.5: FE X4.1: 24 V _{SEN} X4.2: n.c. X4.3: 0 V _{SEN} X4.4: Input x+3 X4.5: FE	X1.1: 24 V _{SEN x} X1.2: Input x+1 X1.3: 0 V _{SEN x} X1.4: Input x X1.5: FE X2.1: 24 V _{SEN x+2} X2.2: Input x+3 X2.3: 0 V _{SEN x+2} X2.4: Input x+2 X2.5: FE	X3.1: 24 V _{SEN x+4} X3.2: Input x+5 X3.3: 0 V _{SEN x+4} X3.4: Input x+4 X3.5: FE X4.1: 24 V _{SEN x+6} X4.2: Input x+7 X4.3: 0 V _{SEN x+6} X4.4: Input x+6 X4.5: FE

1) Speedcon quick lock, additional shielding on metal thread

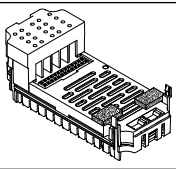
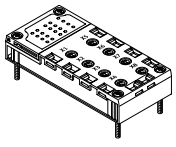
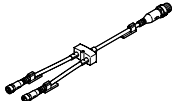

Data sheet – Input module, digital

Pin allocation		CPX-4DE		CPX-8DE, CPX-8DE-D and CPX-8NDE	
CPX-AB-8-KL-4POL					
	X1.0: 24 V _{SEN}	X5.0: 24 V _{SEN}	X1.0: 24 V _{SEN x}	X5.0: 24 V _{SEN x+4}	
	X1.1: 0 V _{SEN}	X5.1: 0 V _{SEN}	X1.1: 0 V _{SEN x}	X5.1: 0 V _{SEN x+4}	
	X1.2: Input x	X5.2: Input x+2	X1.2: Input x	X5.2: Input x+4	
	X1.3: FE	X5.3: FE	X1.3: FE	X5.3: FE	
	X2.0: 24 V _{SEN}	X6.0: 24 V _{SEN}	X2.0: 24 V _{SEN x+1}	X6.0: 24 V _{SEN x+5}	
	X2.1: 0 V _{SEN}	X6.1: 0 V _{SEN}	X2.1: 0 V _{SEN x+1}	X6.1: 0 V _{SEN x+5}	
	X2.2: Input x+1	X6.2: Input x+3	X2.2: Input x+1	X6.2: Input x+5	
	X2.3: FE	X6.3: FE	X2.3: FE	X6.3: FE	
	X3.0: 24 V _{SEN}	X7.0: 24 V _{SEN}	X3.0: 24 V _{SEN x+2}	X7.0: 24 V _{SEN x+6}	
	X3.1: 0 V _{SEN}	X7.1: 0 V _{SEN}	X3.1: 0 V _{SEN x+2}	X7.1: 0 V _{SEN x+6}	
	X3.2: Input x+1	X7.2: Input x+3	X3.2: Input x+2	X7.2: Input x+6	
	X3.3: FE	X7.3: FE	X3.3: FE	X7.3: FE	
	X4.0: 24 V _{SEN}	X8.0: 24 V _{SEN}	X4.0: 24 V _{SEN x+3}	X8.0: 24 V _{SEN x+7}	
	X4.1: 0 V _{SEN}	X8.1: 0 V _{SEN}	X4.1: 0 V _{SEN x+3}	X8.1: 0 V _{SEN x+7}	
X4.2: n.c.	X8.2: n.c.	X4.2: Input x+3	X8.2: Input x+7		
X4.3: FE	X8.3: FE	X4.3: FE	X8.3: FE		
CPX-AB-1-SUB-BU-25POL					
	1: Input x	14: Input x+2	1: Input x	14: Input x+4	
	2: Input x+1	15: Input x+3	2: Input x+1	15: Input x+5	
	3: Input x+1	16: Input x+3	3: Input x+2	16: Input x+6	
	4: n.c.	17: n.c.	4: Input x+3	17: Input x+7	
	5: 24 V _{SEN}	18: 24 V _{SEN}	5: 24 V _{SEN x+1}	18: 24 V _{SEN x+4}	
	6: 0 V _{SEN}	19: 24 V _{SEN}	6: 0 V _{SEN x+1}	19: 24 V _{SEN x+5}	
	7: 24 V _{SEN}	20: 24 V _{SEN}	7: 24 V _{SEN x+3}	20: 24 V _{SEN x+6}	
	8: 0 V _{SEN}	21: 24 V _{SEN}	8: 0 V _{SEN x+3}	21: 24 V _{SEN x+7}	
	9: 24 V _{SEN}	22: 0 V _{SEN}	9: 24 V _{SEN x}	22: 0 V _{SEN x+2 u. 3}	
	10: 24 V _{SEN}	23: 0 V _{SEN}	10: 24 V _{SEN x+2}	23: 0 V _{SEN x+2 u. 3}	
	11: 0 V _{SEN}	24: 0 V _{SEN}	11: 0 V _{SEN x}	24: 0 V _{SEN x+2 u. 3}	
	12: 0 V _{SEN}	25: FE	12: 0 V _{SEN x+2}	25: FE	
	13: FE	Housing: FE	13: FE	Housing: FE	

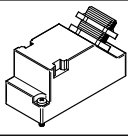
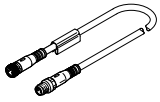
Data sheet – Input module, digital

Ordering data				Part no.	Type
Designation					
Input module, digital					
	4 digital inputs, positive logic (PNP)			195752	CPX-4DE
	8 digital inputs, positive logic (PNP)			195750	CPX-8DE
	8 digital inputs, positive logic (PNP), enhanced diagnostic function			541480	CPX-8DE-D
	8 digital inputs, negative logic (NPN)			543813	CPX-8NDE
Connection block					
	Plastic	8x socket M8, 3-pin		195706	CPX-AB-8-M8-3POL
		4x socket M12, 5-pin		195704	CPX-AB-4-M12X2-5POL
		4x socket, M12 with quick-lock technology, 5-pin		541254	CPX-AB-4-M12X2-5POL-R
		Spring-loaded terminal, 32-pin		195708	CPX-AB-8-KL-4POL
	Metal	4x socket M12, 5-pin		549367	CPX-M-AB-4-M12X2-5POL
Distributor					
	Modular system for all types of sensor/actuator distributor			–	NEDY-... → Internet: nedy
	1x plug M12, 4-pin	2x socket M8, 3-pin		8005311	NEDY-L2R1-V1-M8G3-N-M12G4
		2x socket M12, 5-pin		8005310	NEDY-L2R1-V1-M12G5-N-M12G4
Plug					
	Plug	M8, 3-pin	Solderable	18696	SEA-GS-M8
			Screw-in	192009	SEA-3GS-M8-S
		M12, 4-pin, PG7		18666	SEA-GS-7
		M12, PG7, 4-pin for cable Ø 2.5 mm		192008	SEA-4GS-7-2.5
		M12, 4-pin, PG9		18778	SEA-GS-9
		M12, 4 pin for 2 cables		18779	SEA-GS-11-DUO
		M12 for 2 cables, 5-pin		192010	SEA-5GS-11-DUO
	Sub-D plug, 25-pin			175487	SEA-M12-5GS-PG7
				527522	SD-SUB-D-ST25
Connecting cable					
	Connecting cable M8-M8	0.5 m		541346	NEBU-M8G3-K-0.5-M8G3
		1.0 m		541347	NEBU-M8G3-K-1-M8G3
		2.5 m		541348	NEBU-M8G3-K-2.5-M8G3
		5.0 m		541349	NEBU-M8G3-K-5-M8G3
	Modular system for a choice of connecting cables			–	NEBU-... → Internet: nebu

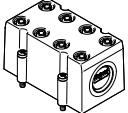
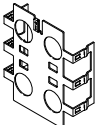
Data sheet – Input module, digital

Ordering data		Part no.	Type	
Designation				
Cover				
	Cover for CPX-AB-8-KL-4POL (IP65, IP67) • 8 cable through feeds M9 • 1 cable through feed for multi-pin plug	538219	AK-8KL	
	Fittings kit	538220	VG-K-M9	
Screening plate				
	Screening plate for M12 connections	526184	CPX-AB-S-4-M12	
User documentation				
	User documentation	German	526439	P.BE-CPX-EA-DE
		English	526440	P.BE-CPX-EA-EN
		Spanish	526441	P.BE-CPX-EA-ES
		French	526442	P.BE-CPX-EA-FR
		Italian	526443	P.BE-CPX-EA-IT

Data sheet – Input module, digital, NAMUR

Function

Digital input modules enable the connection of up to 8 NAMUR sensors (or wired mechanical contacts). In addition, the first 4 channels can alternatively be used as counters or for frequency measurement.

M12 and terminal strip connection technology can be used.

Area of application

- Input modules for 24 V DC sensor supply voltage
- Module features can be parameterised
- The input module receives the supply voltage for the electronics and the sensors from the interlinking block
- Module protection and diagnostics through integrated electronic protection in each channel



General technical data		CPX-P-8DE-N
Type		CPX-P-8DE-N
Number of inputs		8
Maximum cable length	[m]	200
Input debounce time	[ms]	3 (0, 10, 20 parameterisable)
Fuse protection (short circuit)		Internal electronic fuse per channel
Module current consumption (power supply for electronics)	[mA]	Typically 75
Nominal operating voltage	[V DC]	24 (reverse polarity protected)
Permissible voltage fluctuations	[%]	±25
Power failure buffering	[ms]	20
Residual ripple	[Vss]	0.4
Galvanic isolation	Channel – channel	No
	Channel – internal bus	Yes
Input characteristics		To EN 60947-5-6
Switching level		To EN 60947-5-6
LED displays	Group diagnostics	1
	Channel diagnostics	8
	Channel status	8
Diagnostics	Wire break per channel	
	Limit value violation per channel	
	Parameterisation error	
	Overload per channel	
Parameterisation	Data format	
	Input debounce time per channel	
	Input function per channel	
	Replacement value in diagnostic case per channel	
	Upper limit value per channel	
	Signal extension time per channel	
	Gate time per channel	
	Monitoring of limit values per channel	
	Monitoring of short circuit per channel	
	Monitoring of wire break per channel	
	Monitoring of parameters	
	Lower limit value per channel	
	Upper limit value per channel	
	Counter configuration per channel	
Control elements		DIL switch
Additional functions	Frequency measurement	
	Counter function	
Degree of protection to EN 60529		Depending on the connection block

Data sheet – Input module, digital, NAMUR

General technical data		
Grid dimension	[mm]	50
Dimensions (including interlinking block and connection block) W x L x H	[mm]	50 x 107 x 70
Product weight	[g]	100

Materials	
Housing	PA-reinforced PC
Note on materials	RoHS-compliant
PWIS conformity	VDMA24364 zone III

Operating and environmental conditions		
Ambient temperature	[°C]	-5 ... +50
Storage temperature	[°C]	-20 ... +70
Relative humidity	[%]	95, non-condensing

Connection and display components

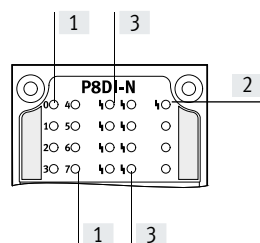

- [1] Status LEDs (green): for allocation to the inputs → pin allocation of the module
- [2] Error LED (red, module error)
- [3] Channel-related error LEDs (red)

Combinations of bus nodes/control blocks with digital input module

Bus node/control block	Part no.	Digital input module
		CPX-P-8DE-N
CPX-CEC-C1-V3	3473128	■
CPX-CEC-M1-V3	3472765	■
CPX-CEC-S1-V3	3472425	■
CPX-FB11	526172	■
CPX-FB13	195740	■
CPX-FB14	526174	■
CPX-FB36	1912451	■
CPX-FB37	2735960	■
CPX-FB43	8110369	■
CPX-M-FB44	8110370	■
CPX-M-FB45	8110371	■





Combinations of connection block and digital input module

Connection blocks	Part no.	Digital input module
		CPX-P-8DE-N
CPX-P-AB-4XM12-4POL	565706	■
CPX-P-AB-2XKL-8POL	565704	■

Data sheet – Input module, digital, NAMUR

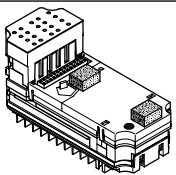
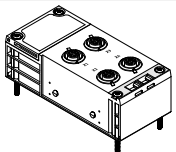
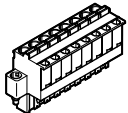
Pin allocation		CPX-P-8DE-N	
Connection block inputs		CPX-P-8DE-N	
CPX-P-AB-4XM12-4POL			
		X1.1: BN+ [0] X1.2: BU- [0] X1.3: BN+ [1] X1.4: BU- [1] X2.1: BN+ [2] X2.2: BU- [2] X2.3: BN+ [3] X2.4: BU- [3]	X3.1: BN+ [4] X3.2: BU- [4] X3.3: BN+ [5] X3.4: BU- [5] X4.1: BN+ [6] X4.2: BU- [6] X4.3: BN+ [7] X4.4: BU- [7]
CPX-P-AB-2XKL-8POL			
		X1.1: BN+ [0] X1.2: BU- [0] X1.3: BN+ [1] X1.4: BU- [1] X1.5: BN+ [2] X1.6: BU- [2] X1.7: BN+ [3] X1.8: BU- [3]	X2.1: BN+ [4] X2.2: BU- [4] X2.3: BN+ [5] X2.4: BU- [5] X2.5: BN+ [6] X2.6: BU- [6] X2.7: BN+ [7] X2.8: BU- [7]
Combinations of interlinking block/digital input module			
Interlinking blocks	Part no.	Digital input module CPX-P-8DE-N	
CPX-GE-EV-S	195746	-	
CPX-GE-EV-S-VL	8022170	-	
CPX-GE-EV-S-7/8-4POL	541248	-	
CPX-M-GE-EV-S-7/8-CIP-4P	568956	-	
CPX-GE-EV-S-7/8-5POL	541244	-	
CPX-GE-EV-S-7/8-5POL-VL	8022172	-	
CPX-M-GE-EV-S-7/8-5POL	550208	■	
CPX-M-GE-EV-S-7/8-5POL-VL	8022165	■	
CPX-M-GE-EV-S-M12-5POL	8098392	-	
CPX-M-GE-EV-S-PP-5POL	563057	-	
CPX-GE-EV	195742	-	
CPX-M-GE-EV	550206	■	
CPX-GE-EV-Z	195744	-	
CPX-GE-EV-Z-VL	8022166	-	
CPX-GE-EV-Z-7/8-4POL	541250	-	
CPX-GE-EV-Z-7/8-5POL	541246	-	
CPX-GE-EV-Z-7/8-5POL-VL	8022173	-	
CPX-M-GE-EV-Z-7/8-5POL	550210	■	
CPX-M-GE-EV-Z-7/8-5POL-VL	8022158	■	
CPX-M-GE-EV-Z-PP-5POL	563058	-	
CPX-GE-EV-V	533577	-	
CPX-GE-EV-V-VL	8022171	-	
CPX-GE-EV-V-7/8-4POL	541252	-	
CPX-M-GE-EV-W-M12-5POL	8098391	-	

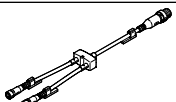
Data sheet – Input module, digital, NAMUR

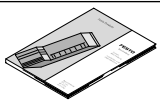
Ordering data					
Designation				Part no.	Type
Input module, digital, NAMUR					
	8 digital inputs			565933	CPX-P-8DE-N
Connection block					
	Plastic	4x socket, M12, 4-pin		565706	CPX-P-AB-4XM12-4POL
		2x plug, 8-pin		565704	CPX-P-AB-2XKL-8POL
Plug					
	Socket	8-pin	Spring-loaded terminal	565712	NECU-L3G8-C1
			Screw terminal	565710	NECU-L3G8-C2
	Plug M12x1, 4-pin, straight, A-coded	Screw terminal	Connection cross section 0.14 ... 0.5 mm ²	192008	SEA-4GS-7-2.5
			Nominal conductor cross section 0.14 ... 0.75 mm ²	18666	SEA-GS-7
			Permissible cable \varnothing 4 ... 6 mm		
			Connection cross section 0.75 mm ²	18778	SEA-GS-9
			Permissible cable \varnothing 6 ... 8 mm		
Distributor					
	Modular system for all types of sensor/actuator distributor			–	NEDY-... → Internet: nedy
Cover					
	Cover cap for closing off unused connections (10 pieces)		For M12 connections	165592	ISK-M12
Coding element					
	To ensure that a coded socket NECU-L3G8 can only be inserted in the matching coded connection block CPX-P-AB-2XKL (96 of each)		For NECU-L3G8	565713	CPX-P-KDS-AB-2XKL
User documentation					
	User documentation		German	575378	P.BE-CPX-P-EA-DE
			English	575379	P.BE-CPX-P-EA-EN
			Spanish	575380	P.BE-CPX-P-EA-ES
			French	575381	P.BE-CPX-P-EA-FR
			Italian	575382	P.BE-CPX-P-EA-IT
			Swedish	575383	P.BE-CPX-P-EA-SV

Data sheet – Input module, digital, PROFI-safe

Function

The PROFI-safe input module has 8 input channels whose signal status is detected for safety reasons, with the information transmitted to a suitable safety controller using the PROFI-safe safety protocol in combination with the appropriate fieldbus (PROFINET or PROFIBUS). This function is exclusively available for safety controllers using the PROFI-safe protocol, profile version 2.4.

Area of application

- Input module for 24 V DC sensor supply voltage
- Supports connection blocks with M12 and terminal connection
- Module features can be parameterised
- The input module receives the supply voltage for the electronics and the sensors from the interlinking block
- Module protection and diagnostics through integrated electronic protection

**Description**

Module-based passivation

While channel-based passivation is disabled, the input module, in accordance with PROFI-safe specification, switches all information in the input image to the safe status, even when there is only one channel error.

Channel-based passivation

In the case of channel-based passivation, when a channel error occurs, the input module switches the input information of the affected channel pair to 0, depending on the function mode.

- The input information for unaffected channel pairs does not change
- The input module remains integrated.
- The input module indicates the current channel error status to the control unit via the input image.

Applications

The inputs on the PROFI-safe input module can be combined for multi-channel sensor applications. Every two inputs form a channel pair, which is set separately with one of 11 function modes.

The function mode has an influence on the evaluation of the input signals, and optionally on the generation of clock signals.

There are 5 independent clock outputs available for safe operation of passive sensors; the pulse patterns are used in some operating modes to detect crossovers in the signal paths.

The entire input module is designed to ensure that the input channels provide either secure data or no data at all, even when an error is present in the system

Range of applications

- Use as an input module for a higher-order safety controller. Several input modules can be used together and these monitor mutually independent sensors
- Use of multi-channel sensor applications with up to 8 secure inputs, which can be grouped and are suitable for configuration with the help of 11 different function modes
- Connection of various switches and sensors within the safety chain
- Output of an identifier coded by DIL switch in the connection block CPX-AB-ID-P

**Note**

The safety integrity level, Performance Level and category for the system as a whole correspond to that of the component in the safety chain with the lowest characteristic value.

Application examples

- Two-hand control device for starting a function
- Emergency stop switch for incidents
- Operating mode selector switch with four positions
- Rotary indexing table
- Light curtain
- Acknowledge button with request
- End-position switch
- Protective door with two NO switches

Data sheet – Input module, digital, PROFIsafe

General technical data			
Type	CPX-F8DE-P		
Number of inputs	8		
Safety function	Reliable detection and evaluation of input statuses		
Max. address capacity	Inputs	[byte]	6
	Outputs	[byte]	7
Maximum cable length			[m] 200
Max. power supply	Per module	[A]	3
Current consumption of module			[mA] Typically 35 (power supply for electronics)
Operating voltage	Nominal value	[V DC]	24
	Permissible range	[V DC]	20.4 ... 28.8
Voltage drop per channel			[V] 0.6
Residual ripple			[Vss] 2 within voltage range
Galvanic isolation	Channel – channel	No	
Input characteristics	To IEC 61131-2, type 2		
Switching logic	Inputs	PNP (positive switching)	
Safety integrity level	As per EN 62061	Reliable detection and evaluation of input statuses up to SIL CL3	
	As per EN 61508	Reliable detection and evaluation of input statuses up to SIL3	
Performance Level	As per ISO 13849	Reliable detection and evaluation of input statuses up to Cat 4 and PL e	
Failure rate per hour (PFH)	1.0x 10 ⁻⁹		
Certificate issuing authority	01/205/5444.01/21		
LED displays	Group diagnostics	1	
	Channel diagnostics	8	
	Channel status	8	
	Failsafe protocol active	1	
Diagnostics	<ul style="list-style-type: none"> • Short circuit per channel • Undervoltage • Overvoltage • Excessive temperature • Crossover per channel • Wire break per channel • Communication • Process data error • Self-test 		
Control elements	DIL switch		
Degree of protection to EN 60529	Depending on connection block		
Grid dimension	[mm]	50	
Dimensions (including interlinking block and connection block) W x L x H	[mm]	50 x 107 x 55	
Product weight	[g]	46	

Data sheet – Input module, digital, PROFIsafe

Materials		
Note on materials		RoHS-compliant
PWIS conformity		VDMA24364-B2-L
Operating and environmental conditions		
Ambient temperature	[°C]	-5 ... +50
Storage temperature	[°C]	-20 ... +70
CE marking (see declaration of conformity) ¹⁾		To EU Machinery Directive
		To EU EMC Directive
		To EU RoHS Directive
UKCA marking (see declaration of conformity) ¹⁾		To UK instructions for machines
		To UK instructions for EMC
		To UK RoHS instructions
Certification		c UL us - Recognized (OL)

1) Additional information at: www.festo.com/catalogue/... → Support/Downloads.

Connection and display components

CPX-F8DE-P

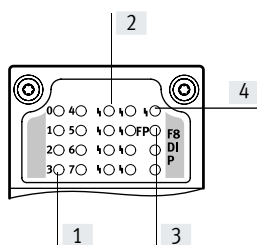

- [1] Channel-related status LEDs (green)
- [2] Channel-related error LEDs (red)
- [3] Fail-safe protocol active (green)
- [4] Error LED (red, module error)

Combinations of bus nodes/control blocks with PROFIsafe input module

Bus node/control block	Part no.	PROFIsafe input module
		CPX-F8DE-P
CPX-FB13	195740	■
CPX-FB43	8110369	■
CPX-M-FB44	8110370	■
CPX-M-FB45	8110371	■

Note
 The PROFIsafe input module CPX-F8DE-P can only be integrated as of software release 21 or release 30 (in the case of CPX-FB13).

Data sheet – Input module, digital, PROFIsafe

Combinations of connection blocks and PROFIsafe input module		
Connection blocks	Part no.	PROFIsafe input module
		CPX-F8DE-P
CPX-M-AB-4-M12X2-5POL	549367	■
CPX-M-AB-4-M12X2-5POL-T	2639560	■
CPX-AB-8-KL-4POL	195708	■
CPX-AB-ID-P	2639571	■

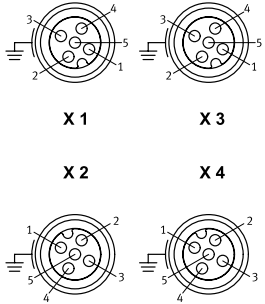
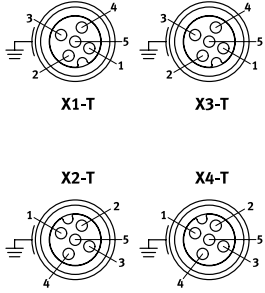
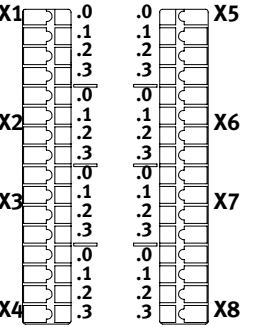
Pin allocation	
Connection block inputs	CPX-F8DE-P
CPX-M-AB-4-M12X2-5POL	
 <p>X 1 X 3 X 2 X 4</p>	<p>X1.1: 24 V_{SEN} X1.2: Input x+1 X1.3: 0 V_{SEN} X1.4: Input x X1.5: FE X2.1: 24 V_{SEN} X2.2: Input x+3 X2.3: 0 V_{SEN} X2.4: Input x+2 X2.5: FE X3.1: 24 V_{SEN} X3.2: Input x+5 X3.3: 0 V_{SEN} X3.4: Input x+4 X3.5: FE X4.1: 24 V_{SEN} X4.2: Input x+7 X4.3: 0 V_{SEN} X4.4: Input x+6 X4.5: FE</p>
CPX-M-AB-4-M12X2-5POL-T	
 <p>X1-T X3-T X2-T X4-T</p>	<p>X1-T.1: 24 V_{SEN x} X1-T.2: Input x+1 X1-T.3: 0 V_{SEN} X1-T.4: Input x X1-T.5: 24 V_{SEN x+1} X2-T.1: 24 V_{SEN x+2} X2-T.2: Input x+3 X2-T.3: 0 V_{SEN} X2-T.4: Input x+2 X2-T.5: 24 V_{SEN x+3} X3-T.1: 24 V_{SEN x+4} X3-T.2: Input x+5 X3-T.3: 0 V_{SEN} X3-T.4: Input x+4 X3-T.5: 24 V_{SEN x+5} X4-T.1: 24 V_{SEN x+6} X4-T.2: Input x+7 X4-T.3: 0 V_{SEN} X4-T.4: Input x+6 X4-T.5: 24 V_{SEN x+7}</p>
CPX-AB-8-KL-4POL	
 <p>X1 X5 X2 X6 X3 X7 X4 X8</p>	<p>X1.0: 24 V_{SEN} X1.1: 0 V_{SEN} X1.2: Input x X1.3: FE X2.0: 24 V_{SEN x} X2.1: 24 V_{SEN x+1} X2.2: Input x+1 X2.3: FE X3.0: 24 V_{SEN} X3.1: 0 V_{SEN} X3.2: Input x+2 X3.3: FE X4.0: 24 V_{SEN x+2} X4.1: 24 V_{SEN x+3} X4.2: Input x+3 X4.3: FE X5.0: 24 V_{SEN} X5.1: 0 V_{SEN} X5.2: Input x+4 X5.3: FE X6.0: 24 V_{SEN x+4} X6.1: 24 V_{SEN x+5} X6.2: Input x+5 X6.3: FE X7.0: 24 V_{SEN} X7.1: 0 V_{SEN} X7.2: Input x+6 X7.3: FE X8.0: 24 V_{SEN x+6} X8.1: 24 V_{SEN x+7} X8.2: Input x+7 X8.3: FE</p>

Data sheet – Input module, digital, PROFIsafe

General technical data	
Type	CPX-AB-ID-P
Certificate issuing authority	01/205/5444.00/15 German Technical Control Board (TÜV) Rh. UK 01/205U/5444.00/22
Degree of protection to EN 60529	IP65
Housing material	PA PC
Note on materials	RoHS-compliant
PWIS conformity	VDMA24364-B2-L
Corrosion resistance class CRC ¹⁾	1
Product weight [g]	57

1) Additional information: www.festo.com/x/topic/kbk

Combinations of interlinking blocks and PROFIsafe input module		
Interlinking blocks	Part no.	PROFIsafe input module
		CPX-F8DE-P
CPX-GE-EV-S	195746	–
CPX-GE-EV-S-VL	8022170	–
CPX-GE-EV-S-7/8-4POL	541248	–
CPX-GE-EV-S-7/8-5POL	541244	–
CPX-GE-EV-S-7/8-5POL-VL	8022172	–
CPX-M-GE-EV-S-7/8-CIP-4P	568956	■
CPX-M-GE-EV-S-7/8-5POL	550208	■
CPX-M-GE-EV-S-7/8-5POL-VL	8022165	■
CPX-M-GE-EV-S-M12-5POL	8098392	■
CPX-M-GE-EV-S-PP-5POL	563057	■
CPX-GE-EV	195742	–
CPX-M-GE-EV	550206	■
CPX-M-GE-EV-FVO	567806	–
CPX-GE-EV-Z	195744	–
CPX-GE-EV-Z-VL	8022166	–
CPX-GE-EV-Z-7/8-4POL	541250	–
CPX-GE-EV-Z-7/8-5POL	541246	–
CPX-GE-EV-Z-7/8-5POL-VL	8022173	–
CPX-M-GE-EV-Z-7/8-5POL	550210	■
CPX-M-GE-EV-Z-7/8-5POL-VL	8022158	■
CPX-M-GE-EV-Z-PP-5POL	563058	■
CPX-GE-EV-V	533577	–
CPX-GE-EV-V-VL	8022171	–
CPX-GE-EV-V-7/8-4POL	541252	–
CPX-M-GE-EV-W-M12-5POL	8098391	■

Data sheet – Input module, digital, PROFI-safe

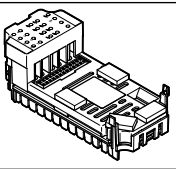
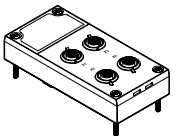
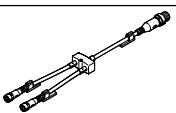
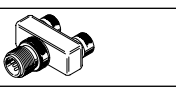
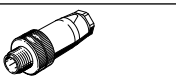
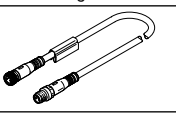
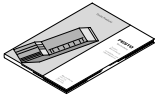
Ordering data		Description	Part no.	Type	
PROFI-safe input module					
	8 digital inputs, positive logic (PNP), for reliable detection and evaluation of input statuses		2597424	CPX-F8DE-P	
Connection block					
	Plastic	Spring-loaded terminal, 32-pin	195708	CPX-AB-8-KL-4POL	
		8-way DIL switch	2639571	CPX-AB-ID-P	
	Metal	4x socket M12, 5-pin	Unpulsed sensor supply	549367	CPX-M-AB-4-M12X2-5POL
			Pulsed sensor supply	2639560	CPX-M-AB-4-M12X2-5POL-T
Distributor					
	Modular system for all types of sensor/actuator distributor		–	NEDY-... → Internet: nedy	
	1x plug M12, 4-pin	2x socket M12, 5-pin	8005310	NEDY-L2R1-V1-M12G5-N-M12G4	
Plug					
	Plug	M12, PG7	18666	SEA-GS-7	
		M12, PG7, 4-pin for cable \varnothing 2.5 mm	192008	SEA-4GS-7-2.5	
		M12, PG9	18778	SEA-GS-9	
		M12 for 2 cables	18779	SEA-GS-11-DUO	
		M12 for 2 cables, 5-pin	192010	SEA-5GS-11-DUO	
		M12, 5-pin	175487	SEA-M12-5GS-PG7	
Connecting cable					
	Modular system for a choice of connecting cables		–	NEBU-... → Internet: nebu	
User documentation					
	User documentation for PROFI-safe input module	German	8035496	CPX-F8DE-P-DE	
		English	8035497	CPX-F8DE-P-EN	
		Spanish	8035498	CPX-F8DE-P-ES	
		French	8035499	CPX-F8DE-P-FR	
		Italian	8035500	CPX-F8DE-P-IT	
		Chinese	8035501	CPX-F8DE-P-ZH	

Data sheet – Input module, digital, 16 inputs

Function

Digital input modules enable the connection of two-wire and three-wire sensors (proximity switches, inductive or capacitive sensors, etc.).

Depending on the connection block selected, the module supports various connection concepts with different numbers of sockets (single or double allocation).

Area of application

- Input modules for 24 V DC sensor supply voltage
- PNP logic
- Module features can be parameterised
- The input module receives the supply voltage for the electronics and the sensors from the interlinking block
- Module protection and diagnostics through integrated electronic protection

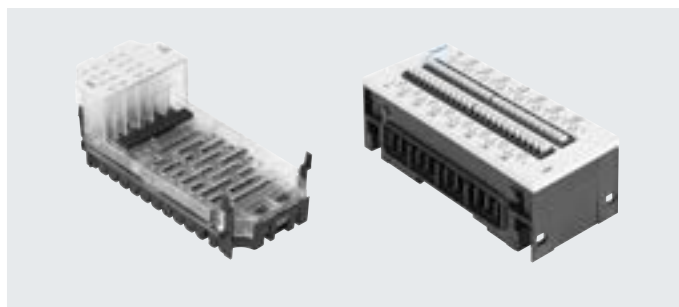

General technical data		CPX-16DE	CPX-M-16DE-D	CPX-L-16DE
Type				
Number of inputs		16	16	16
Max. residual current of inputs per module	[A]	1.8	1.8	1.8
Intrinsic current consumption at operating voltage	[mA]	Typically 15	Typically 34	Typically 15
Fuse protection		Internal electronic fuse per module	Internal electronic fuse per channel pair, additional safety fuse	Internal electronic fuse per module
Nominal operating voltage	[V DC]	24	24	24
Operating voltage range	[V DC]	18 ... 30	18 ... 30	18 ... 30
Galvanic isolation	Channel – channel	No	No	No
	Channel – internal bus	No	No	No
Switching level	Signal 0	[V DC] ≤ 5	≤ 5	≤ 5
	Signal 1	[V DC] ≥ 11	≥ 11	≥ 15
Input debounce time	[ms]	3 (0.1 ms, 10 ms, 20 ms parameterisable)		
Input characteristic		IEC 1131-T2	IEC 1131-T2	IEC 1131-T2, type 01
Switching logic		Positive logic (PNP)	Positive logic (PNP)	Positive logic (PNP)
LED displays	Group diagnostics	1	1	1
	Channel diagnostics	–	16	–
	Channel status	16	16	16
Diagnostics		Short circuit/overload per channel		
Parameterisation		<ul style="list-style-type: none"> • Module monitoring • Behaviour after short circuit • Input debounce time • Signal extension time 		
Degree of protection to EN 60529		Depending on connection block	Depending on connection block	IP20
Temperature range	Operation	[°C] –5 ... +50	–5 ... +50	–5 ... +50
	Storage/transport	[°C] –20 ... +70	–20 ... +70	–20 ... +70
Certification		–	–	c UL us - Listed (OL)
Materials		Reinforced PA, PC	Reinforced PA, PC	PA-reinforced
Note on materials		–	–	RoHS-compliant
PWIS conformity		VDMA24364-B2-L	VDMA24364-B2-L	VDMA24364-B2-L
Grid dimension	[mm]	50	50	50
Dimensions (including interlinking block and connection block) W x L x H	[mm]	50 x 107 x 50	50 x 107 x 50	50 x 107 x 41
Product weight	[g]	41	46	167

Data sheet – Input module, digital, 16 inputs

Connection and display components

CPX-16DE

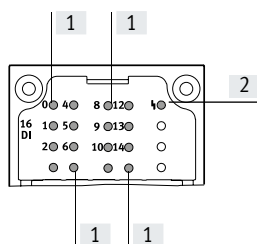

- [1] Status LEDs (green): for allocation to the inputs → pin allocation of the module
- [2] Error LED (red, module error)

CPX-M-16DE-D

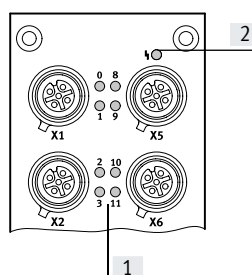

- [1] Common status LEDs (green)/error LEDs (red) for each input signal
- [2] Error LED (red, module error)

CPX-L-16DE

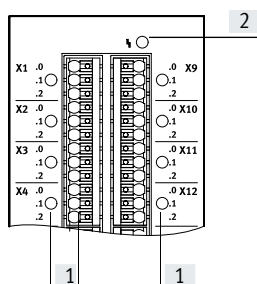

- [1] Status LEDs (green) for each input signal
- [2] Error LED (red, module error)









Combinations of connection blocks and digital input modules

Connection blocks	Part no.	Digital input modules		
		CPX-16DE	CPX-M-16DE-D	CPX-L-16DE
CPX-AB-8-M8X2-4POL	541256	■	–	–
CPX-AB-8-M12X2-5POL	3606900	–	■	–
CPX-AB-8-KL-4POL	195708	■	–	–
CPX-AB-1-SUB-BU-25POL	525676	■	–	–
CPX-M-AB-8-M12X2-5POL	549335	–	■	–

Data sheet – Input module, digital, 16 inputs

Pin allocation		CPX-16DE
Connection block inputs		
CPX-AB-8-M8x2-4POL		
	<p>X1.1: 24 V_{SEN} X1.2: Input x+1 X1.3: 0 V_{SEN} X1.4: Input x X2.1: 24 V_{SEN} X2.2: Input x+3 X2.3: 0 V_{SEN} X2.4: Input x+2 X3.1: 24 V_{SEN} X3.2: Input x+5 X3.3: 0 V_{SEN} X3.4: Input x+4 X4.1: 24 V_{SEN} X4.2: Input x+7 X4.3: 0 V_{SEN} X4.4: Input x+6</p>	<p>X5.1: 24 V_{SEN} X5.2: Input x+9 X5.3: 0 V_{SEN} X5.4: Input x+8 X6.1: 24 V_{SEN} X6.2: Input x+11 X6.3: 0 V_{SEN} X6.4: Input x+10 X7.1: 24 V_{SEN} X7.2: Input x+13 X7.3: 0 V_{SEN} X7.4: Input x+12 X8.1: 24 V_{SEN} X8.1: Input x+15 X8.3: 0 V_{SEN} X8.4: Input x+14</p>
CPX-AB-8-KL-4POL		
	<p>X1.0: Input x+8 X1.1: 24 V_{SEN} X1.2: Input x X1.3: FE X2.0: Input x+9 X2.1: 24 V_{SEN} X2.2: Input x+1 X2.3: FE X3.0: Input x+10 X3.1: 24 V_{SEN} X3.2: Input x+2 X3.3: FE X4.0: Input x+11 X4.1: 24 V_{SEN} X4.2: Input x+3 X4.3: FE</p>	<p>X5.0: Input x+12 X5.1: 0 V_{SEN} X5.2: Input x+4 X5.3: FE X6.0: Input x+13 X6.1: 0 V_{SEN} X6.2: Input x+5 X6.3: FE X7.0: Input x+14 X7.1: 0 V_{SEN} X7.2: Input x+6 X7.3: FE X8.0: Input x+15 X8.1: 0 V_{SEN} X8.2: Input x+7 X8.3: FE</p>
CPX-AB-1-SUB-BU-25POL		
	<p>1: Input x 2: Input x+1 3: Input x+2 4: Input x+3 5: Input x+9 6: 24 V_{SEN} 7: Input x+11 8: 24 V_{SEN} 9: Input x+8 10: Input x+10 11: 24 V_{SEN} 12: 24 V_{SEN} 13: FE</p>	<p>14: Input x+4 15: Input x+5 16: Input x+6 17: Input x+7 18: Input x+12 19: Input x+13 20: Input x+14 21: Input x+15 22: 0 V_{SEN} 23: 0 V_{SEN} 24: 0 V_{SEN} 25: FE Housing: FE</p>



Data sheet – Input module, digital, 16 inputs

Pin allocation		CPX-M-16DE-D
Connection block inputs		
CPX-M-AB-8-M12X2-5POL and CPX-AB-8-M12X2-5POL		
 <p>X 1</p>	 <p>X 5</p>	<p>X1.1: $24 V_{Sx}$</p> <p>X1.2: Input x+1</p> <p>X1.3: $0 V_{Sx}$</p> <p>X1.4: Input x</p> <p>X1.5: FE</p>
 <p>X 2</p>	 <p>X 6</p>	<p>X2.1: $24 V_{Sx+2}$</p> <p>X2.2: Input x+3</p> <p>X2.3: $0 V_{Sx+2}$</p> <p>X2.4: Input x+2</p> <p>X2.5: FE</p>
 <p>X 3</p>	 <p>X 7</p>	<p>X3.1: $24 V_{Sx+4}$</p> <p>X3.2: Input x+5</p> <p>X3.3: $0 V_{Sx+4}$</p> <p>X3.4: Input x+4</p> <p>X3.5: FE</p>
 <p>X 4</p>	 <p>X 8</p>	<p>X4.1: $24 V_{Sx+6}$</p> <p>X4.2: Input x+7</p> <p>X4.3: $0 V_{Sx+6}$</p> <p>X4.4: Input x+6</p> <p>X4.5: FE</p>
		<p>X5.1: $24 V_{Sx+8}$</p> <p>X5.2: Input x+9</p> <p>X5.3: $0 V_{Sx+8}$</p> <p>X5.4: Input x+8</p> <p>X5.5: FE</p>
		<p>X6.1: $24 V_{Sx+10}$</p> <p>X6.2: Input x+11</p> <p>X6.3: $0 V_{Sx+10}$</p> <p>X6.4: Input x+10</p> <p>X6.5: FE</p>
		<p>X7.1: $24 V_{Sx+12}$</p> <p>X7.2: Input x+13</p> <p>X7.3: $0 V_{Sx+12}$</p> <p>X7.4: Input x+12</p> <p>X7.5: FE</p>
		<p>X8.1: $24 V_{Sx+14}$</p> <p>X8.2: Input x+15</p> <p>X8.3: $0 V_{Sx+14}$</p> <p>X8.4: Input x+14</p> <p>X8.5: FE</p>

Data sheet – Input module, digital, 16 inputs

Pin allocation		CPX-L-16DE	
Connection block inputs			
		X1.0: 24 V _{SEN}	X9.0: 24 V _{SEN}
		X1.1: Input x	X9.1: Input x+8
		X1.2: 0 V _{SEN}	X9.2: 0 V _{SEN}
		X2.0: 24 V _{SEN}	X10.0: 24 V _{SEN}
		X2.1: Input x+1	X10.1: Input x+9
		X2.2: 0 V _{SEN}	X10.2: 0 V _{SEN}
		X3.0: 24 V _{SEN}	X11.0: 24 V _{SEN}
		X3.1: Input x+2	X11.1: Input x+10
		X3.2: 0 V _{SEN}	X11.2: 0 V _{SEN}
		X4.0: 24 V _{SEN}	X12.0: 24 V _{SEN}
		X4.1: Input x+3	X12.1: Input x+11
		X4.2: 0 V _{SEN}	X12.2: 0 V _{SEN}
		X5.0: 24 V _{SEN}	X13.0: 24 V _{SEN}
		X5.1: Input x+4	X13.1: Input x+12
		X5.2: 0 V _{SEN}	X13.2: 0 V _{SEN}
		X6.0: 24 V _{SEN}	X14.0: 24 V _{SEN}
		X6.1: Input x+5	X14.1: Input x+13
		X6.2: 0 V _{SEN}	X14.2: 0 V _{SEN}
		X7.0: 24 V _{SEN}	X15.0: 24 V _{SEN}
		X7.1: Input x+6	X15.1: Input x+14
		X7.2: 0 V _{SEN}	X15.2: 0 V _{SEN}
		X8.0: 24 V _{SEN}	X16.0: 24 V _{SEN}
		X8.1: Input x+7	X16.1: Input x+15
		X8.2: 0 V _{SEN}	X16.2: 0 V _{SEN}

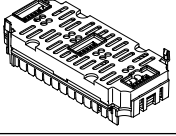
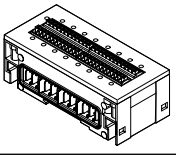
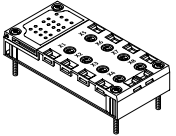
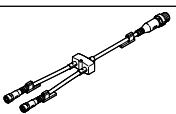
Data sheet – Input module, digital, 16 inputs

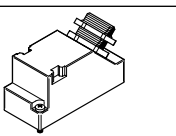
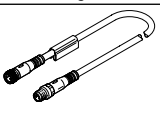
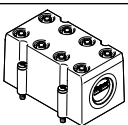
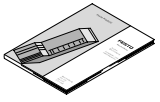
Ordering data		Part no.	Type	
Designation				
Input module, digital				
	16 digital inputs, internal electronic fuse per module	543815	CPX-16DE	
	16 digital inputs, internal electronic fuse per channel pair, for CPX in metal	550202	CPX-M-16DE-D	
	16 digital inputs, internal electronic fuse per module, for CPX in plastic, including interlinking block and connection block with spring-loaded terminals	572606	CPX-L-16DE-16-KL-3POL	
Connection block				
	Plastic	8x socket M8, 4-pin	541256	CPX-AB-8-M8X2-4POL
		8x socket M12, 5-pin	3606900	CPX-AB-8-M12X2-5POL
		Spring-loaded terminal, 32-pin	195708	CPX-AB-8-KL-4POL
		1x socket, Sub-D, 25-pin	525676	CPX-AB-1-SUB-BU-25POL
	Metal	8x socket M12, 5-pin	549335	CPX-M-AB-8-M12X2-5POL
Distributor				
	Modular system for all types of sensor/actuator distributor		–	NEDY-... → Internet: nedy
	1x plug M8, 4-pin	2x socket M8, 3-pin	8005312	NEDY-L2R1-V1-M8G3-N-M8G4
Plug				
	Plug M8, 3-pin	Solderable	18696	SEA-GS-M8
		Screw-in	192009	SEA-3GS-M8-S
	Sub-D plug, 25-pin		527522	SD-SUB-D-ST25
Connecting cable				
	Connecting cable M8-M8	0.5 m	541346	NEBU-M8G3-K-0.5-M8G3
		1.0 m	541347	NEBU-M8G3-K-1-M8G3
		2.5 m	541348	NEBU-M8G3-K-2.5-M8G3
		5.0 m	541349	NEBU-M8G3-K-5-M8G3
	Modular system for a choice of connecting cables		–	NEBU-... → Internet: nebu
Cover				
	Cover for CPX-AB-8-KL-4POL (IP65, IP67) • 8 cable through feeds M9 • 1 cable through feed for multi-pin plug		538219	AK-8KL
	Fittings kit		538220	VG-K-M9
User documentation				
	User documentation	German	526439	P.BE-CPX-EA-DE
		English	526440	P.BE-CPX-EA-EN
		Spanish	526441	P.BE-CPX-EA-ES
		French	526442	P.BE-CPX-EA-FR
		Italian	526443	P.BE-CPX-EA-IT

Data sheet – Output module, digital

Function

Digital outputs control actuators such as individual valves, hydraulic valves, heating controllers and many more. Separate circuits are created using an additional supply. Parallel connection of the outputs of a module enables consuming devices to be controlled with up to 4 A.

Area of application

- Output module for 24 V DC supply voltage
- PNP logic
- Module features can be parameterised
- The output module receives the voltage supply for the electronics and the outputs from the interlinking block
- Module protection and diagnostics through integrated electronic protection in each channel



General technical data			CPX-4DA	CPX-8DA	CPX-8DA-H
Type					
Number of outputs			4	8	8
Max. power supply	Per module	[A]	4		8.4
	Per channel	[A]	1 (24 W lamp load, 4 channels can be connected in parallel)	0.5 (12 W lamp load, 8 channels can be connected in parallel)	2.1 (50 W lamp load), per channel pair
Fuse protection (short circuit)			Internal electronic fuse per channel		
Module current consumption (power supply for electronics)		[mA]	Typically 16		Typically 34
Operating voltage	Nominal value	[V DC]	24		
	Permissible range	[V DC]	18 ... 30		
Galvanic isolation	Channel – channel		No		
	Channel – internal bus		Yes, with intermediate supply		
Output characteristic			Based on IEC 1131-2		
Switching logic			Positive logic (PNP)		
LED displays	Group diagnostics		1	1	1
	Channel diagnostics		4	8	8
	Channel status		4	8	8
Diagnostics			<ul style="list-style-type: none"> • Short circuit/overload, channel x • Undervoltage of outputs 		
Parameterisation			<ul style="list-style-type: none"> • Module monitoring • Behaviour after short circuit • Fail-safe channel x • Forcing channel x • Idle mode channel x 		
Degree of protection to EN 60529			Depending on connection block		
Temperature range	Operation	[°C]	–5 ... +50		
	Storage/transport	[°C]	–20 ... +70		
Materials			Reinforced PA, PC		
PWIS conformity			VDMA24364-B2-L		
Grid dimension		[mm]	50		
Dimensions (including interlinking block and connection block) W x L x H		[mm]	50 x 107 x 50		
Product weight		[g]	42	49	48

Data sheet – Output module, digital

Connection and display components

CPX-4DA

CPX-8DA

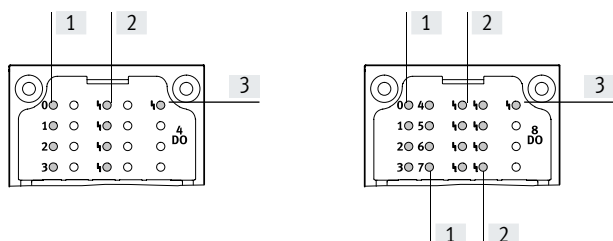

- [1] Status LEDs (yellow): for allocation to outputs → pin allocation of the module
 [2] Channel-related error LEDs (red)
 [3] Error LED (red, module error)

Combinations of connection block and digital output module

Connection blocks	Part no.	Digital output module		
		CPX-4DA	CPX-8DA	CPX-8DA-H
CPX-AB-8-M8-3POL	195706	■	■	–
CPX-AB-8-M8X2-4POL	541256	■	■	■
CPX-AB-4-M12X2-5POL	195704	■	■	–
CPX-AB-4-M12X2-5POL-R	541254	■	■	■
CPX-AB-8-KL-4POL	195708	■	■	■
CPX-AB-1-SUB-BU-25POL	525676	■	■	■
CPX-M-AB-4-M12X2-5POL	549367	■	■	■

Pin allocation

Connection block outputs	CPX-4DA	CPX-8DA
CPX-AB-8-M8-3POL		
	X1.1: n.c. X1.3: 0 V _{OUT} X1.4: Output x	X5.1: n.c. X5.3: 0 V _{OUT} X5.4: Output x+2
	X2.1: n.c. X2.3: 0 V _{OUT} X2.4: Output x+1	X6.1: n.c. X6.3: 0 V _{OUT} X6.4: Output x+3
	X3.1: n.c. X3.3: 0 V _{OUT} X3.4: Output x+1	X7.1: n.c. X7.3: 0 V _{OUT} X7.4: Output x+3
	X4.1: n.c. X4.3: 0 V _{OUT} X4.4: n.c.	X8.1: n.c. X8.3: 0 V _{OUT} X8.4: n.c.
		X1.1: n.c. X1.3: 0 V _{OUT} X1.4: Output x
		X5.1: n.c. X5.3: 0 V _{OUT} X5.4: Output x+4
		X2.1: n.c. X2.3: 0 V _{OUT} X2.4: Output x+1
		X6.1: n.c. X6.3: 0 V _{OUT} X6.4: Output x+5
		X3.1: n.c. X3.3: 0 V _{OUT} X3.4: Output x+2
		X7.1: n.c. X7.3: 0 V _{OUT} X7.4: Output x+6
		X4.1: n.c. X4.3: 0 V _{OUT} X4.4: Output x+3
		X8.1: n.c. X8.3: 0 V _{OUT} X8.4: Output x+7

Data sheet – Output module, digital

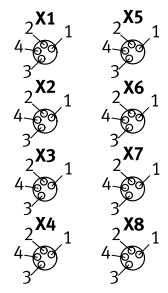
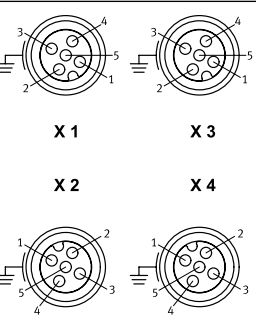
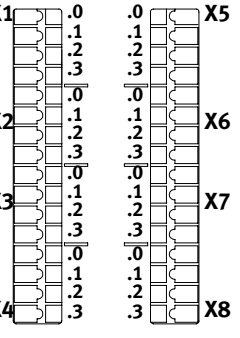

Pin allocation		CPX-4DA		CPX-8DA and CPX-8DA-H	
Connection block outputs		CPX-4DA		CPX-8DA and CPX-8DA-H	
CPX-AB-8-M8X2-4POL					
		X1.1: 0 V _{OUT} X1.2: Output x+1 X1.3: 0 V _{OUT} X1.4: Output x X2.1: 0 V _{OUT} X2.2: n.c. X2.3: 0 V _{OUT} X2.4: Output x+1 X3.1: 0 V _{OUT} X3.2: Output x+3 X3.3: 0 V _{OUT} X3.4: Output x+2 X4.1: 0 V _{OUT} X4.2: n.c. X4.3: 0 V _{OUT} X4.4: Output x+3	X5.1: 0 V _{OUT} X5.2: n.c. X5.3: 0 V _{OUT} X5.4: n.c. X6.1: 0 V _{OUT} X6.2: n.c. X6.3: 0 V _{OUT} X6.4: n.c. X7.1: 0 V _{OUT} X7.2: n.c. X7.3: 0 V _{OUT} X7.4: n.c. X8.1: 0 V _{OUT} x+1 X8.2: n.c. X8.3: 0 V _{OUT} x+3 X8.4: n.c.	X1.1: 0 V _{OUT} X1.2: Output x+1 X1.3: 0 V _{OUT} X1.4: Output x X2.1: 0 V _{OUT} X2.2: Output x+3 X2.3: 0 V _{OUT} X2.4: Output x+2 X3.1: 0 V _{OUT} X3.2: Output x+5 X3.3: 0 V _{OUT} X3.4: Output x+4 X4.1: 0 V _{OUT} X4.2: Output x+7 X4.3: 0 V _{OUT} X4.4: Output x+6	X5.1: 0 V _{OUT} X5.2: n.c. X5.3: 0 V _{OUT} X5.4: n.c. X6.1: 0 V _{OUT} X6.2: n.c. X6.3: 0 V _{OUT} X6.4: n.c. X7.1: 0 V _{OUT} X7.2: n.c. X7.3: 0 V _{OUT} X7.4: n.c. X8.1: 0 V _{OUT} X8.2: n.c. X8.3: 0 V _{OUT} X8.4: n.c.
CPX-AB-4-M12X2-5POL¹⁾ and CPX-AB-4-M12X2-5POL-R²⁾					
		X1.1: n.c. X1.2: Output x+1 X1.3: 0 V _{OUT} X1.4: Output x X1.5: FE X2.1: n.c. X2.2: n.c. X2.3: 0 V _{OUT} X2.4: Output x+1 X2.5: FE	X3.1: n.c. X3.2: Output x+3 X3.3: 0 V _{OUT} X3.4: Output x+2 X3.5: FE X4.1: n.c. X4.2: n.c. X4.3: 0 V _{OUT} X4.4: Output x+3 X4.5: FE	X1.1: n.c. X1.2: Output x+1 X1.3: 0 V _{OUT} X1.4: Output x X1.5: FE X2.1: n.c. X2.2: Output x+3 X2.3: 0 V _{OUT} X2.4: Output x+2 X2.5: FE	X3.1: n.c. X3.2: Output x+5 X3.3: 0 V _{OUT} X3.4: Output x+4 X3.5: FE X4.1: n.c. X4.2: Output x+7 X4.3: 0 V _{OUT} X4.4: Output x+6 X4.5: FE
CPX-AB-8-KL-4POL					
		X1.0: n.c. X1.1: 0 V _{OUT} X1.2: Output x X1.3: FE X2.0: n.c. X2.1: 0 V _{OUT} X2.2: Output x+1 X2.3: FE X3.0: n.c. X3.1: 0 V _{OUT} X3.2: Output x+1 X3.3: FE X4.0: n.c. X4.1: 0 V _{OUT} X4.2: n.c. X4.3: FE	X5.0: n.c. X5.1: 0 V _{OUT} X5.2: Output x+2 X5.3: FE X6.0: n.c. X6.1: 0 V _{OUT} X6.2: Output x+3 X6.3: FE X7.0: n.c. X7.1: 0 V _{OUT} X7.2: Output x+3 X7.3: FE X8.0: n.c. X8.1: 0 V _{OUT} X8.2: n.c. X8.3: FE	X1.0: n.c. X1.1: 0 V _{OUT} X1.2: Output x X1.3: FE X2.0: n.c. X2.1: 0 V _{OUT} X2.2: Output x+1 X2.3: FE X3.0: n.c. X3.1: 0 V _{OUT} X3.2: Output x+2 X3.3: FE X4.0: n.c. X4.1: 0 V _{OUT} X4.2: Output x+3 X4.3: FE	X5.0: n.c. X5.1: 0 V _{OUT} X5.2: Output x+4 X5.3: FE X6.0: n.c. X6.1: 0 V _{OUT} X6.2: Output x+5 X6.3: FE X7.0: n.c. X7.1: 0 V _{OUT} X7.2: Output x+6 X7.3: FE X8.0: n.c. X8.1: 0 V _{OUT} X8.2: Output x+7 X8.3: FE

1) Not suitable for CPX-8DA-H.
 2) Speedcon quick lock, additional shielding on metal thread

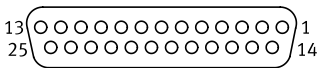

Data sheet – Output module, digital

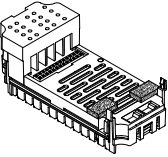
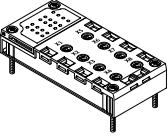
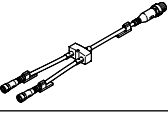
Pin allocation		CPX-4DA		CPX-8DA and CPX-8DA-H				
Connection block outputs		CPX-4DA		CPX-8DA and CPX-8DA-H				
CPX-AB-1-SUB-BU-25POL								
	1:	Output x	14:	Output x+2	1:	Output x	14:	Output x+4
	2:	Output x+1	15:	Output x+3	2:	Output x+1	15:	Output x+5
	3:	Output x+1	16:	Output x+3	3:	Output x+2	16:	Output x+6
	4:	n.c.	17:	n.c.	4:	Output x+3	17:	Output x+7
	5:	n.c.	18:	n.c.	5:	n.c.	18:	n.c.
	6:	0 V _{OUT}	19:	n.c.	6:	0 V _{OUT}	19:	n.c.
	7:	n.c.	20:	n.c.	7:	n.c.	20:	n.c.
	8:	0 V _{OUT}	21:	n.c.	8:	0 V _{OUT}	21:	n.c.
	9:	n.c.	22:	0 V _{OUT}	9:	n.c.	22:	0 V _{OUT}
	10:	n.c.	23:	0 V _{OUT}	10:	n.c.	23:	0 V _{OUT}
	11:	0 V _{OUT}	24:	0 V _{OUT}	11:	0 V _{OUT}	24:	0 V _{OUT}
	12:	0 V _{OUT}	25:	FE	12:	0 V _{OUT}	25:	FE
	13:	FE	Housing: FE		13:	FE	Housing: FE	

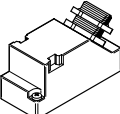
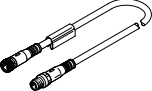
Data sheet – Output module, digital

Ordering data		Part no.	Type		
Designation					
Output module, digital					
	4 digital outputs, power supply 1 A per channel	195754	CPX-4DA		
	8 digital outputs, power supply 0.5 A per channel	541482	CPX-8DA		
	8 digital outputs, power supply 2.1 A per channel pair	550204	CPX-8DA-H		
Connection block					
	Plastic	8x socket M8, 3-pin	195706	CPX-AB-8-M8-3POL	
		8x socket M8, 4-pin	541256	CPX-AB-8-M8X2-4POL	
		4x socket M12, 5-pin	195704	CPX-AB-4-M12X2-5POL	
		4x socket, M12 with quick-lock technology, 5-pin	541254	CPX-AB-4-M12X2-5POL-R	
		Spring-loaded terminal, 32-pin	195708	CPX-AB-8-KL-4POL	
	1x socket, Sub-D, 25-pin	525676	CPX-AB-1-SUB-BU-25POL		
Metal	4x socket M12, 5-pin	549367	CPX-M-AB-4-M12X2-5POL		
Distributor					
	Modular system for all types of sensor/actuator distributor		–	NEDY-... → Internet: nedy	
	1x plug M8, 4-pin	2x socket M8, 3-pin	8005312	NEDY-L2R1-V1-M8G3-N-M8G4	
	1x plug M12, 4-pin	2x socket M8, 3-pin	8005311	NEDY-L2R1-V1-M8G3-N-M12G4	
		2x socket M12, 5-pin	8005310	NEDY-L2R1-V1-M12G5-N-M12G4	
Plug					
	Plug	M8 3-pin	Solderable	18696	SEA-GS-M8
			Screw-in	192009	SEA-3GS-M8-S
		M12, PG7		18666	SEA-GS-7
		M12, PG7, 4-pin for cable ø 2.5 mm		192008	SEA-4GS-7-2.5
		M12, PG9		18778	SEA-GS-9
		M12 for 2 cables		18779	SEA-GS-11-DUO
M12 for 2 cables, 5-pin		192010	SEA-5GS-11-DUO		
M12, 5-pin		175487	SEA-M12-5GS-PG7		
	Sub-D plug, 25-pin		527522	SD-SUB-D-ST25	
Connecting cable					
	Connecting cable M8-M8	0.5 m	541346	NEBU-M8G3-K-0.5-M8G3	
		1.0 m	541347	NEBU-M8G3-K-1-M8G3	
		2.5 m	541348	NEBU-M8G3-K-2.5-M8G3	
		5.0 m	541349	NEBU-M8G3-K-5-M8G3	
	Modular system for a choice of connecting cables		–	NEBU-... → Internet: nebu	

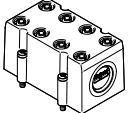
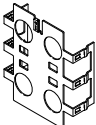
Data sheet – Output module, digital

Ordering data		Part no.	Type	
Designation				
Cover				
	Cover for CPX-AB-8-KL-4POL (IP65, IP67) • 8 cable through feeds M9 • 1 cable through feed for multi-pin plug	538219	AK-8KL	
	Fittings kit	538220	VG-K-M9	
Screening plate				
	Screening plate for M12 connections	526184	CPX-AB-S-4-M12	
User documentation				
	User documentation	German	526439	P.BE-CPX-EA-DE
		English	526440	P.BE-CPX-EA-EN
		Spanish	526441	P.BE-CPX-EA-ES
		French	526442	P.BE-CPX-EA-FR
		Italian	526443	P.BE-CPX-EA-IT

Data sheet – Input/output module, digital

Area of application

- Digital multi I/O module for 24 V DC supply voltage
- Supports connection blocks with Sub-D, terminal connection and M12 connection (8-pin)
- As CPX-L with connection via spring-loaded terminals
- Module features can be parameterised
- The inputs receive the voltage supply for the electronics and the sensors from the interlinking block
- The outputs receive the voltage supply for the electronics and the outputs from the interlinking block
- Module protection and diagnostics through integrated electronic fuse protection for the sensor power supply and integrated electronic fuse protection in each output channel

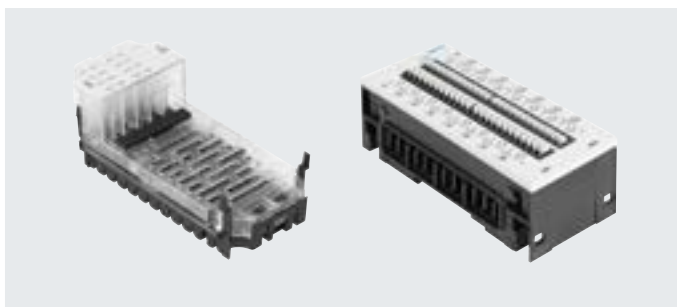

General technical data			CPX-8DE-8DA	CPX-L-8DE-8DA
Type				
Number	Inputs		8	8
	Outputs		8	8
Max. power supply Per module	Sensor supply	[A]	0.7	1.8
	Outputs	[A]	4	2
Max. power supply per channel		[A]	0.5 (12 W lamp load, channels A0 ... A03 can be connected in parallel to A4 ... A7)	0.25 (6 W lamp load)
Fuse protection (short circuit)			Internal electronic fuse per channel	
Intrinsic current consumption at nominal operating voltage		[mA]	Typically 22	Typically 15
Operating voltage	Nominal value	[V DC]	24	24
	Permissible range	[V DC]	18 ... 30	18 ... 30
Galvanic isolation, inputs	Channel – channel		No	No
	Channel – internal bus		No	No
Galvanic isolation, outputs	Channel – channel		No	No
	Channel – internal bus		Yes, with intermediate supply	No
Characteristic curve	Inputs		IEC 1131-T2	IEC 1131-T2, type 01
	Outputs		IEC 1131-T2	IEC 1131-T2
Switching level, inputs	Signal 0	[V DC]	≤ 5	≤ 5
	Signal 1	[V DC]	≥ 11	≥ 15
Input debounce time		[ms]	3 (0.1 ms, 10 ms, 20 ms parameterisable)	
Switching logic			Positive logic (PNP)	Positive logic (PNP)
LED displays	Group diagnostics		1	1
	Channel diagnostics		–	–
	Channel status		16	16
Diagnostics			<ul style="list-style-type: none"> • Short circuit/overload per channel • Undervoltage of outputs 	
Parameterisation			<ul style="list-style-type: none"> • Input debounce time • Failsafe per channel • Forcing per channel • Idle mode per channel • Signal extension time • Module monitoring • Behaviour after short circuit 	
Degree of protection to EN 60529			Depending on connection block	IP20
Temperature range	Operation	[°C]	–5 ... +50	–5 ... +50
	Storage/transport	[°C]	–20 ... +70	–20 ... +70
Certification			–	c UL - Recognized (OL)
Materials			Reinforced PA, PC	PA-reinforced
Note on materials			–	RoHS-compliant
PWIS conformity			VDMA24364-B2-L	VDMA24364-B2-L
Grid dimension		[mm]	50	50
Dimensions (including interlinking block and connection block) W x L x H		[mm]	50 x 107 x 50	50 x 107 x 41
Product weight		[g]	48	171

Data sheet – Input/output module, digital

Connection and display components

CPX-8DE-8DA

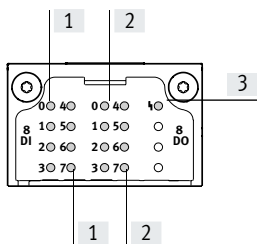

- [1] Status LEDs (green): for allocation to the inputs → pin allocation of the module
- [2] Status LEDs (yellow): for allocation to the inputs → pin allocation of the module
- [3] Error LED (red) (module error)

CPX-L-8DE-8DA

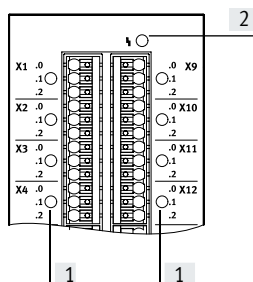

- [1] Status LEDs (green) for each input signal
- [2] Error LED (red, module error)

Connection block/digital I/O module combinations

Connection blocks	Part no.	Digital I/O module	
		CPX-8DE-8DA	CPX-L-8DE-8DA
CPX-AB-4-M12-8POL	526178	■	-
CPX-AB-8-KL-4POL	195708	■	-
CPX-AB-1-SUB-BU-25POL	525676	■	-

Pin allocation

Connection block inputs/outputs

CPX-8DE-8DA

CPX-AB-4-M12-8POL

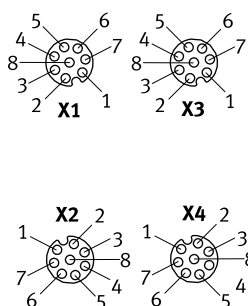

- X1.1: 24 V_{SEN}
- X1.2: Input x
- X1.3: Input x+1
- X1.4: 0 V_{SEN}
- X1.5: Output x
- X1.6: Output x+1
- X1.7: Input x+4
- X1.8: 0 V_{OUT}
- X2.1: 24 V_{SEN}
- X2.2: Input x+2
- X2.3: Input x+3
- X2.4: 0 V_{SEN}
- X2.5: Output x+2
- X2.6: Output x+3
- X2.7: Input x+6
- X2.8: 0 V_{OUT}

- X3.1: 24 V_{SEN}
- X3.2: Input x+4
- X3.3: Input x+5
- X3.4: 0 V_{SEN}
- X3.5: Output x+4
- X3.6: Output x+5
- X3.7: n.c.
- X3.8: 0 V_{OUT}
- X4.1: 24 V_{SEN}
- X4.2: Input x+6
- X4.3: Input x+7
- X4.4: 0 V_{SEN}
- X4.5: Output x+6
- X4.6: Output x+7
- X4.7: n.c.
- X4.8: 0 V_{OUT}

Data sheet – Input/output module, digital

Pin allocation		CPX-8DE-8DA
CPX-AB-8-KL-4POL		
	<p>X1.0: 24 V_{SEN} X1.1: 0 V_{SEN} X1.2: Input x X1.3: FE</p> <p>X2.0: Input x+4 X2.1: Input x+5 X2.2: Input x+1 X2.3: FE</p> <p>X3.0: 24 V_{SEN} X3.1: 0 V_{SEN} X3.2: Input x+2 X3.3: FE</p> <p>X4.0: Input x+6 X4.1: Input x+7 X4.2: Input x+3 X4.3: FE</p>	<p>X5.0: Output x+4 X5.1: 0 V_{OUT} X5.2: Output x X5.3: FE</p> <p>X6.0: Output x+5 X6.1: 0 V_{OUT} X6.2: Output x+1 X6.3: FE</p> <p>X7.0: Output x+6 X7.1: 0 V_{OUT} X7.2: Output x+2 X7.3: FE</p> <p>X8.0: Output x+7 X8.1: 0 V_{OUT} X8.2: Output x+3 X8.3: FE</p>
CPX-AB-1-SUB-BU-25POL		
	<p>1: Input x 2: Input x+1 3: Input x+2 4: Input x+3 5: Input x+4 6: Input x+5 7: Input x+6 8: Input x+7 9: 24 V_{SEN} 10: 24 V_{SEN} 11: 0 V_{SEN} 12: 0 V_{SEN} 13: FE</p>	<p>14: Output x 15: Output x+1 16: Output x+2 17: Output x+3 18: Output x+4 19: Output x+5 20: Output x+6 21: Output x+7 22: 0 V_{OUT} 23: 0 V_{OUT} 24: 0 V_{OUT} 25: FE Housing: FE</p>

Data sheet – Input/output module, digital

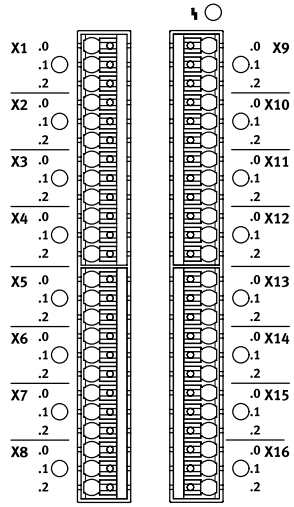
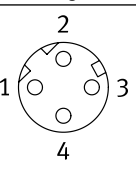
Pin allocation		CPX-L-8DE-8DA	
Connection block inputs			
	<p>X1.0: 24 V_{SEN}</p> <p>X1.1: Input x</p> <p>X1.2: 0 V_{SEN}+out</p> <p>X2.0: 24 V_{SEN}</p> <p>X2.1: Input x+1</p> <p>X2.2: 0 V_{SEN}+out</p> <p>X3.0: 24 V_{SEN}</p> <p>X3.1: Input x+2</p> <p>X3.2: 0 V_{SEN}+out</p> <p>X4.0: 24 V_{SEN}</p> <p>X4.1: Input x+3</p> <p>X4.2: 0 V_{SEN}+out</p> <p>X5.0: 24 V_{SEN}</p> <p>X5.1: Input x+4</p> <p>X5.2: 0 V_{SEN}+out</p> <p>X6.0: 24 V_{SEN}</p> <p>X6.1: Input x+5</p> <p>X6.2: 0 V_{SEN}+out</p> <p>X7.0: 24 V_{SEN}</p> <p>X7.1: Input x+6</p> <p>X7.2: 0 V_{SEN}+out</p> <p>X8.0: 24 V_{SEN}</p> <p>X8.1: Input x+7</p> <p>X8.2: 0 V_{SEN}+out</p>	<p>X9.0: 24 V_{SEN}</p> <p>X9.1: Output x</p> <p>X9.2: 0 V_{SEN}+out</p> <p>X10.0: 24 V_{SEN}</p> <p>X10.1: Output x+1</p> <p>X10.2: 0 V_{SEN}+out</p> <p>X11.0: 24 V_{SEN}</p> <p>X11.1: Output x+2</p> <p>X11.2: 0 V_{SEN}+out</p> <p>X12.0: 24 V_{SEN}</p> <p>X12.1: Output x+3</p> <p>X12.2: 0 V_{SEN}+out</p> <p>X13.0: 24 V_{SEN}</p> <p>X13.1: Output x+4</p> <p>X13.2: 0 V_{SEN}+out</p> <p>X14.0: 24 V_{SEN}</p> <p>X14.1: Output x+5</p> <p>X14.2: 0 V_{SEN}+out</p> <p>X15.0: 24 V_{SEN}</p> <p>X15.1: Output x+6</p> <p>X15.2: 0 V_{SEN}+out</p> <p>X16.0: 24 V_{SEN}</p> <p>X16.1: Output x+7</p> <p>X16.2: 0 V_{SEN}+out</p>	
Interlinking block		CPX-L-8DE-8DA	
		<p>The module combines the 0 V potential of the power supply for electronics and sensors with the 0 V potential of the power supply for outputs in the CPX interlinking module.</p> <p>If all pins of the outputs of an output module connected to the right of the input/output module are to be switched off, an appropriate interlinking block with additional supply for outputs must be used to the right of the input/output module.</p>	

Data sheet – Input/output module, digital

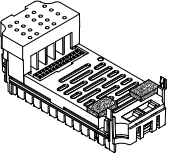
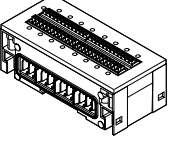
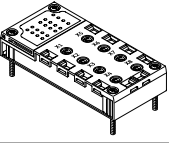
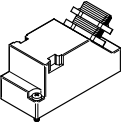
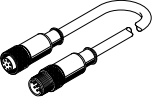
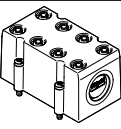
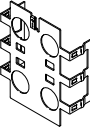
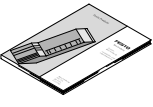
Ordering data		Part no.	Type
Designation			
Input/output module, digital			
	8 digital inputs, 8 digital outputs	526257	CPX-8DE-8DA
	8 digital inputs, 8 digital outputs, for CPX in plastic, including interlinking block and connection block with spring-loaded terminals	572607	CPX-L-8DE-8DA-16-KL-3POL
Connection block			
	Plastic	4x socket M12, 8-pin	526178 CPX-AB-4-M12-8POL
		Spring-loaded terminal, 32-pin	195708 CPX-AB-8-KL-4POL
		1x socket, Sub-D, 25-pin	525676 CPX-AB-1-SUB-BU-25POL
Plug			
	Sub-D plug, 25-pin	527522	SD-SUB-D-ST25
Connecting cable			
	Connecting cable M12	525617	KM12-8GD8GS-2-PU
Cover			
	Cover for CPX-AB-8-KL-4POL (IP65, IP67)	538219	AK-8KL
	<ul style="list-style-type: none"> • 8 cable through feeds M9 • 1 cable through feed for multi-pin plug Fittings kit	538220	VG-K-M9
Screening plate			
	Screening plate for M12 connections	526184	CPX-AB-S-4-M12
User documentation			
	User documentation	German	526439 P.BE-CPX-EA-DE
		English	526440 P.BE-CPX-EA-EN
		Spanish	526441 P.BE-CPX-EA-ES
		French	526442 P.BE-CPX-EA-FR
		Italian	526443 P.BE-CPX-EA-IT

Data sheet – Counter module, digital

Function

The counter module has two channels. Depending on the parameterisation, these can independently be used as counter inputs or as incremental value encoder inputs or SSI. The counter module additionally has one output per channel. The outputs can either be controlled by a counter channel or an incremental value encoder channel, i.e. through an event such as "Comparative value reached". Alternatively, outputs can also be controlled via process data.

Area of application

- Continuous counting
- One-off counting to count limit
- One-off counting to count limit, return to load value
- Periodic counting
- Measurement of frequencies
- Measurement of rotational speeds
- Measurement of duty cycle
- Measurement of position
- Measurement of speed
- Measuring with pulse generators
- Measurement with pulse generators and direction encoders
- Measurement with incremental encoders
- Measurement with SSI absolute encoders

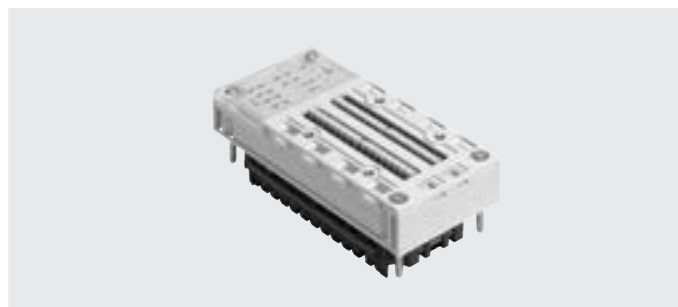

Description

Applications

- | | | | |
|---|--|---|---|
| <ul style="list-style-type: none"> • Recording travel and speed of a conveyor • Position and speed synchronisation of conveyors and pick & place applications • Counting goods e.g. in packaging installations | <ul style="list-style-type: none"> • Systems for filling by weight and volume • Monitoring motor speeds • Measuring equipment for determining the position of axis systems (linear, rotational) | <ul style="list-style-type: none"> • Controlling fast-switching valves • Controlling the opening time of a valve • Activating semiconductor relays | <ul style="list-style-type: none"> • Temperature monitoring and rotational speed control for drives • Change of direction in fast drives • Control of motors with pulse-width modulation (PWM) |
|---|--|---|---|

Supported devices

- | | | | |
|---|--|--|--|
| <ul style="list-style-type: none"> • 5 V incremental encoder, single-ended or differential, with two 90° phase offset tracks | <ul style="list-style-type: none"> • 24 V incremental encoder, single-ended, with two 90° phase offset tracks | <ul style="list-style-type: none"> • 24 V pulse generator with or without direction level • 24 V direct current motors | <ul style="list-style-type: none"> • Absolute encoder with SSI interface (13 bits to 25 bits) |
|---|--|--|--|

Data sheet – Counter module, digital

General technical data			CPX-2ZE2DA
Type			CPX-2ZE2DA
Number	Inputs		2
	Outputs		2
Max. power supply Per module	Inputs	[A]	2
	Outputs	[A]	10
Max. power supply per channel		[A]	5 (adjustable, 20 W lamp load)
Max. cable length		[m]	30
Fuse protection (short circuit)			Internal electronic fuse per channel
Intrinsic current consumption at nominal operating voltage		[mA]	Typically 35
Operating voltage	Nominal value	[V DC]	24
	Permissible range	[V DC]	18 ... 30
Galvanic isolation, inputs	Channel – channel		No
	Channel – internal bus		No
Galvanic isolation, outputs	Channel – channel		No
	Channel – internal bus		Yes, with intermediate supply
Characteristic curve	Inputs		To IEC 1131-2, type O2
	Outputs		IEC 1131-T2
Switching level	Signal 0	[V DC]	≤ 5
	Signal 1	[V DC]	≥ 11
Input debounce time		[μs]	0.1 (0.2 μs, 0.4 μs, 0.8 μs, 1 μs, 2 μs, 4 μs, 8 μs, 10 μs, 50 μs, 100 μs, 500 μs, 1 ms, 3 ms, 10 ms, 20 ms parameterisable)
Switching logic	Inputs		Positive logic (PNP)
	Outputs		<ul style="list-style-type: none"> • Negative logic (NPN) • Positive logic (PNP) • Push-pull driver
LED displays	Group diagnostics		1
	Channel diagnostics		2
	Channel status		10
	Module diagnostics		2
Diagnostics			Operating mode-dependent diagnostics
Parameterisation			<ul style="list-style-type: none"> • Switch-on/off delay • Frequency output • Speed measurement • Impulse output • Pulse train • Rotational speed measurement • Frequency measurement • Period duration measurement • Motor operating mode • Determine position • Pulse width modulation • One-off counting • Continuous counting • Periodic counting
Degree of protection to EN 60529			IP65, IP67
Temperature range	Operation	[°C]	-5 ... +50
	Storage/transport	[°C]	-20 ... +70
Certification			UL – Recognized (OL)
Information on materials: Housing			Plastic
Note on materials			RoHS-compliant
PWIS conformity			VDMA24364-B2-L
Grid dimension		[mm]	50
Dimensions (including interlinking block and connection block) W x L x H		[mm]	50 x 107 x 50
Product weight		[g]	130

Data sheet – Counter module, digital

Connection and display components

CPX-2ZE2DA

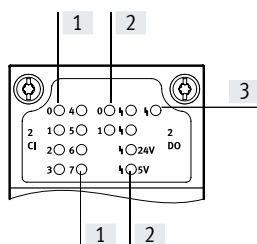

- [1] Status LEDs (green): for allocation to the inputs → pin allocation of the module
- [2] Status LEDs (yellow, red): for allocation to the inputs a pin allocation of the module
- [3] Error LED (red) (module error)

Pin allocation

Inputs/outputs



CPX-2ZE2DA

Inputs/outputs		CPX-2ZE2DA	
		Channel 0	Channel 1
X1 .0 .1 .2 .3 X2 .0 .1 .2 .3 X3 .0 .1 .2 .3 X4 .0 .1 .2 .3	X5 .0 .1 .2 .3 X6 .0 .1 .2 .3 X7 .0 .1 .2 .3 X8 .0 .1 .2 .3	X1.0: Input	X5.0: Input
		X1.1: Input	X5.1: Input
		X1.2: Input	X5.2: Input
		X1.3: Input	X5.3: Input
		X2.0: Input	X6.0: Input
		X2.1: Input	X6.1: Input
		X2.2: 5 V DC	X6.2: 5 V DC
		X2.3: 0 V	X6.3: 0 V
		X3.0: 24 V DC	X7.0: 24 V DC
		X3.1: 0 V	X7.1: 0 V
		X3.2: 24 V DC for digital input DI	X7.2: 24 V DC for digital input DI
		X3.3: Digital input DI	X7.3: Digital input DI
X4.0: 0 V for digital input DI	X8.0: 0 V for digital input DI		
X4.1: Digital output DO	X8.1: Digital output DO		
X4.2: Reference potential for DO	X8.2: Reference potential for DO		
X4.3: FE	X8.3: FE		

 Note

The allocation and designation of inputs differs fundamentally depending on which type of encoder is connected. Appropriate allocation diagrams can be found in the user documentation for the counter module.

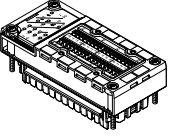
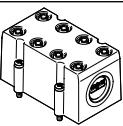
Data sheet – Counter module, digital

Ordering data		Part no.	Type
Designation			
Counter module, digital			
	2 digital inputs, 2 digital outputs	576046	CPX-2ZE2DA
Cover			
	Cover for CPX-2ZE2DA (IP65, IP67) • 8 cable through feeds M9 • 1 cable through feed for multi-pin plug	538219	AK-8KL
	Fittings kit	538220	VG-K-M9
User documentation			
	User documentation for counter module CPX-2ZE2DA	German	8035733 P.BE-CPX-2ZE2DA-DE
		English	8035734 P.BE-CPX-2ZE2DA-EN
		Spanish	8035735 P.BE-CPX-2ZE2DA-ES
		French	8035736 P.BE-CPX-2ZE2DA-FR
		Italian	8035737 P.BE-CPX-2ZE2DA-IT
		Chinese	8035738 P.BE-CPX-2ZE2DA-ZH

Data sheet – HART input/output module

Function

The HART input/output module allows the connection of up to 4 sensors or actuators. The corresponding communication channel is made available for sensors or actuators that communicate using the HART protocol.

With the HART protocol, a conventional analogue 4 ... 20 mA current signal is modulated by a second frequency-modulated signal.

Each of the 4 connections of the module can be configured as inputs or outputs.

Area of application

- Multi I/O module for 24 V DC supply voltage
- Supports connection blocks with M12 and terminal connection
- Module features can be parameterised
- The module receives the voltage supply for the electronics, outputs and the sensors from the interlinking block
- Module protection and diagnostics through integrated electronic protection

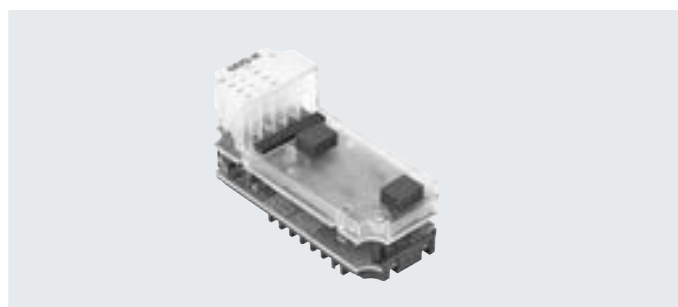

General technical data		CPX-4AE-4AA-H		
Type		CPX-4AE-4AA-H		
Protocol		HART		
Number of selectable analogue inputs/outputs		4		
Type of sensor		0 ... 20 mA	4 ... 20 mA	4 ... 20 mA with HART
Operating voltage	Nominal value	[V DC]	24	
	Permissible range	[V DC]	18 ... 30	
Power failure buffering		[ms]	10	
Intrinsic current consumption at nominal operating voltage		[mA]	Typically 170	
Maximum short circuit current		[mA]	22	
Maximum open circuit voltage		[V]	28.8	
Minimum available sensor voltage		20.7 V DC at 20 mA		
Fuse protection (short circuit)		Internal electronic fuse per channel		
Reverse polarity protection		For all electrical connections		
Galvanic isolation	Channel – channel	No		
	Channel – internal bus	Yes		
Signal range		0 ... 20 mA	4 ... 20 mA	4 ... 20 mA with HART
Data format		15 bits + prefix		
		Scalable to 15 bits		
Maximum load		[Ω]	750	
Maximum input resistance		[Ω]	300	
Maximum cable length		[m]	500	
Basic error limit at 25°C		[%]	±0.1	
Operating error limit related to the ambient temperature range		[%]	±0.3	
Repetition accuracy		0.05% at 20°C		
LED displays	Group diagnostics	1		
	Channel diagnostics	4		
	Channel status	4		
Control elements		DIL switch		
Diagnostics		<ul style="list-style-type: none"> • Wire break per channel • Limit value violation per channel • Short circuit/overload per channel • Parameterisation error • Overflow/underflow • Limit value violation to NE43 per channel 		

Data sheet – HART input/output module

General technical data	
Parameterisation	<ul style="list-style-type: none"> • Data format • Failsafe per channel • Forcing per channel • Limit value monitoring per channel • Idle mode per channel • Measured value smoothing • Signal range per channel • Monitoring overflow/underflow • Monitoring to NE43, inputs • Monitoring of wire break per channel • Wire break per channel • Limit value violation per channel • Short circuit/overload per channel • Parameterisation error • Overflow/underflow • Limit value violation to NE43 per channel • Number of HART repetitions • Hysteresis for limit values • HART variables (4 pieces) • Behaviour after short circuit/overload
Degree of protection to EN 60529	Depending on connection block

Technical data – Mechanical components	
Type of mounting	On interlinking block
Product weight [g]	77.4
Grid dimension [mm]	50
Dimensions (including interlinking block and connection block) W x L x H [mm]	50 x 107 x 70

Materials	
Housing	Reinforced PA, PC
Note on materials	RoHS-compliant
PWIS conformity	VDMA24364-B2-L

Operating and environmental conditions	
Ambient temperature [°C]	-5 ... +50
Storage temperature [°C]	-20 ... +70
Relative humidity [%]	95, non-condensing
Corrosion resistance class CRC ¹⁾	1 (when installed)
CE marking (see declaration of conformity) ³⁾	To EU EMC Directive ²⁾

1) Additional information: www.festo.com/x/topic/kbk

2) For information about the area of use, see the EC declaration of conformity at: www.festo.com/catalogue/... → Support/Downloads.

If the devices are subject to usage restrictions in residential, commercial or light-industrial environments, further measures for the reduction of the emitted interference may be necessary.

3) Additional information: www.festo.com/catalogue/... → Support/Downloads.

Safety characteristics	
Shock resistance	Shock test with severity level 2 to FN 942017-5 and EN 60068-2-27
Vibration resistance	Transport application test with severity level 2 to FN 942017-4 and EN 60068-2-6

Data sheet – HART input/output module

Connection and display components

CPX-4EA-4AA-H

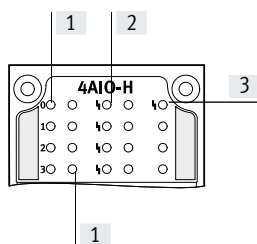

- [1] Status LEDs:
 – Inputs (green)
 – Outputs (yellow)
 → Pin allocation for module
- [2] Error LEDs (red): for allocation to the inputs → pin allocation of the module
- [3] Error LED (red)
 (module error)

Combinations of bus nodes/control blocks with HART input/output module

Bus node/control block	Part no.	Protocol	Can be combined as of release	HART variables in process image only	Full HART functionality
CPX-CEC-C1-V3	3473128	CODESYS Level 2	3.5.12.174	–	■
CPX-CEC-M1-V3	3472765	CODESYS Level 2	3.5.12.174	–	■
CPX-CEC-S1-V3	3472425	CODESYS Level 2	3.5.12.174	–	■
CPX-FB11	526172	DeviceNet	25	■	–
CPX-FB13	195740	PROFIBUS	34	–	■
CPX-FB14	526174	CANopen	30	■	–
CPX-FB36	1912451	EtherNet/IP	15	–	■
CPX-FB37	2735960	EtherCAT	7	■	–
CPX-FB43	8110369	PROFINET RT, M12	45	–	■
CPX-M-FB44	8110370	PROFINET RT, RJ45	45	–	■
CPX-M-FB45	8110371	PROFINET RT, SCRJ	45	–	■

Combinations of connection blocks with HART input/output module

Connection blocks	Part no.	HART input/output module CPX-4EA-4AA-H
CPX-P-AB-4XM12-4POL	565706	■
CPX-P-AB-2XKL-8POL	565704	■

Combinations of connection blocks with interlinking block





Connection blocks	Part no.	Plastic interlinking block CPX-GE...	Metal interlinking block CPX-M-GE...
CPX-P-AB-4XM12-4POL	565706	–	■
CPX-P-AB-2XKL-8POL	565704	■	■

Data sheet – HART input/output module

Pin allocation		CPX-4AE-4AA-H			
Connection block inputs/outputs		Inputs		Outputs	
CPX-P-AB-4XM12-4POL					
		X1.1: $24 V_{SEN\ x}$ X1.2: 0 V X1.3: Input x X1.4: 0 V X2.1: $24 V_{SEN\ x+1}$ X2.2: 0 V X2.3: Input x+1 X2.4: 0 V	X3.1: $24 V_{SEN\ x+2}$ X3.2: 0 V X3.3: Input x+2 X3.4: 0 V X4.1: $24 V_{SEN\ x+3}$ X4.2: 0 V X4.3: Input x+3 X4.4: 0 V	X1.1: Output I0+ X1.2: 0 V X1.3: – X1.4: 0 V X2.1: Output I1+ X2.2: 0 V X2.3: – X2.4: 0 V	X3.1: Output I2+ X3.2: 0 V X3.3: – X3.4: 0 V X4.1: Output I3+ X4.2: 0 V X4.3: – X4.4: 0 V
CPX-P-AB-2XKL-8POL					
		X1.1: $24 V_{SEN\ x}$ X1.2: 0 V X1.3: Input x X1.4: 0 V X1.5: $24 V_{SEN\ x+1}$ X1.6: 0 V X1.7: Input x+1 X1.8: 0 V	X2.1: $24 V_{SEN\ x+2}$ X2.2: 0 V X2.3: Input x+2 X2.4: 0 V X2.5: $24 V_{SEN\ x+3}$ X2.6: 0 V X2.7: Input x+3 X2.8: 0 V	X1.1: Output I0+ X1.2: 0 V X1.3: – X1.4: 0 V X1.5: Output I1+ X1.6: 0 V X1.7: – X1.8: 0 V	X2.1: Output I2+ X2.2: 0 V X2.3: – X2.4: 0 V X2.5: Output I3+ X2.6: 0 V X2.7: – X2.8: 0 V

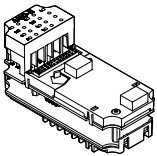
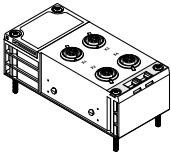
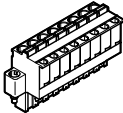
Note
 In the case of mixed operation of inputs and outputs in one module, the connections are first assigned input signals and then output signals, in ascending order.

Data sheet – HART input/output module

Ordering data				Part no.	Type
Designation					
HART input/output module					
	4 analogue inputs/outputs			8059847	CPX-4AE-4AA-H
Connection block					
	Plastic	4x socket, M12, 4-pin		565706	CPX-P-AB-4XM12-4POL
		2x plug, 8-pin		565704	CPX-P-AB-2XKL-8POL
Plug					
	8-pin socket	Spring-loaded terminal	Connection cross section 0.2 ... 2.5 mm ²	565712	NECU-L3G8-C1
		Screw terminal	Connection cross section 0.2 ... 2.5 mm ²	565710	NECU-L3G8-C2
	Plug M12x1, 4-pin, straight, A-coded	Screw terminal	Connection cross section 0.14 ... 0.5 mm ²	192008	SEA-4GS-7-2.5
			Nominal conductor cross section 14 ... 0.75 mm ²	18666	SEA-GS-7
			Permissible cable \varnothing 4 ... 6 mm		
			Connection cross section 0.75 mm ²	18778	SEA-GS-9
			Permissible cable \varnothing 6 ... 8 mm		
Cover					
	Cover cap for sealing unused connections M12x1 (10 pieces)			165592	ISK-M12
Coding element					
	To ensure that a coded socket NECU-L3G8 can only be inserted in the matching coded connection block CPX-P-AB-2XKL (96 of each)		For NECU-L3G8	565713	CPX-P-KDS-AB-2XKL

Data sheet – Input module, analogue

Function

Analogue modules control devices with a standardised analogue interface such as pressure switches, temperature, flow rate, filling level, etc.

Depending on the connection block selected, the analogue module supports various connection concepts with different numbers of sockets or terminals.

Area of application

- Analogue module for 0 ... 10 V, 0 ... 20 mA or 4 ... 20 mA
- Supports connection blocks with Sub-D, terminal connection and M12 connection
- Analogue module features can be parameterised
- Different data formats available
- Operation with and without galvanic isolation possible
- The analogue module receives the voltage supply for the electronics and the sensors from the interlinking block
- Analogue module protection and diagnostics through integrated electronic fuse protection



General technical data		CPX-2AE-U-I		CPX-4AE-U-I		CPX-4AE-I
		Voltage input	Current input	Voltage input	Current input	Current input
Type						
Number of analogue inputs		2		4		4
Max. power supply per module	[A]	0.7				
Fuse protection		Internal electronic fuse				
Current consumption from 24 V sensor supply (quiescent current)	[mA]	Typically 50				
Current consumption from 24 V sensor supply (at full load)	[A]	Max. 0.7				
Nominal operating voltage for load voltage	[V DC]	24 ±2%				
Nominal operating voltage	[V DC]	24				
Operating voltage range	[V DC]	18 ... 30				
Signal range (parameterisable for each channel with DIL switch or software)		0 ... 10 V	0 ... 20 mA 4 ... 20 mA	1 ... 5 V 0 ... 10 V -5 ... +5 V -10 ... +10 V	0 ... 20 mA 4 ... 20 mA -20 ... +20 mA	0 ... 20 mA 4 ... 20 mA
Operational error limit	[%]	±0.5	–	±0.3	±0.3	±0.6
Basic error limit (at 25°C)	[%]	±0.3	–	±0.2	±0.2	±0.5
Repetition accuracy (at 25°C)	[%]	0.15	0.15	0.1	0.1	0.15
Input resistance		100 kΩ	≤ 100 Ω	100 kΩ	≤ 100 Ω	≤ 100 Ω
Max. permissible input voltage	[V DC]	30	–	-30 ... +30	–	–
Max. permissible input current	[mA]	–	40	–	Internally limited to 60	40
Conversion time per channel	[μs]	Typically 150				
Cycle time (module)	[ms]	≤ 4		≤ 0.5		≤ 10
Data format		12 bits + prefix Scalable to 15 bits		15 bits + prefix Scalable to 15 bits		12 bits + prefix Scalable to 15 bits
Cable length	[m]	Max. 30 (shielded)				

Data sheet – Input module, analogue

General technical data		CPX-2AE-U-I	CPX-4AE-U-I	CPX-4AE-I	
Type					
Galvanic isolation	Channel – channel	No			
	Channel – internal bus	Yes, with external sensor supply			
LED displays	Group diagnostics	1			
	Channel diagnostics	Via flashing frequency of group diagnostics	4	Via flashing frequency of group diagnostics	
Diagnostics	Wire break per channel				
	Limit value violation per channel				
	Parameterisation error				
	Short circuit, input signal		Overload at input	Short circuit, input signal	
	–		Overflow/underflow	–	
	–		Short circuit in sensor supply	–	
Parameterisation	Data format				
	Forcing per channel				
	Limit value monitoring per channel				
	Measured value smoothing				
	Signal range per channel				
	Monitoring of wire break per channel				
	Behaviour after short circuit				
	–		Behaviour after overload at input	–	
	–		Sensor supply active	–	
	Degree of protection to EN 60529		Depending on connection block		
Temperature range	Operation	[°C]	–5 ... +50		
	Storage/transport	[°C]	–20 ... +70		
Materials	Reinforced PA, PC				
Note on materials	–		RoHS-compliant	–	
PWIS conformity	VDMA24364-B2-L		VDMA24364-B2-L	VDMA24364-B2-L	
Grid dimension	[mm]	50			
Dimensions (including interlinking block and connection block) W x L x H	[mm]	50 x 107 x 50			
Product weight	[g]	48	46	47	

Data sheet – Input module, analogue

Connection and display components

CPX-2AE-U-I and CPX-4AE-I

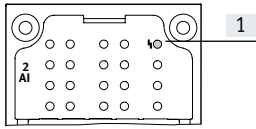

[1] Error LED (red; module error)

CPX-4AE-U-I

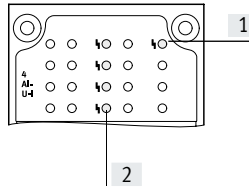

[1] Error LED (red; module error)

[2] Channel-related error LEDs (red)

Combinations of connection blocks and analogue module

Connection blocks	Part no.	Analogue module		
		CPX-2AE-U-I	CPX-4AE-U-I	CPX-4AE-I
CPX-AB-4-M12X2-5POL	195704	■	■	■
CPX-AB-4-M12X2-5POL-R	541254	■	■	■
CPX-AB-8-KL-4POL	195708	■	■	■
CPX-AB-1-SUB-BU-25POL	525676	■	■	■
CPX-M-AB-4-M12X2-5POL	549367	■	■	■

Pin allocation

Connection block inputs	CPX-2AE-U-I	CPX-4AE-U-I	CPX-4AE-I
-------------------------	-------------	-------------	-----------

CPX-AB-4-M12X2-5POL, CPX-AB-4-M12X2-5POL-R¹⁾ and CPX-M-AB-4-M12X2-5POL

	X1.1: 24 V _{SEN}	X3.1: 24 V _{SEN}	X1.1: 24 V _{SEN}	X3.1: 24 V _{SEN}	X1.1: 24 V _{SEN}	X3.1: 24 V _{SEN}
	X1.2: Input U0+	X3.2: Input U1+	X1.2: Input 0+	X3.2: Input 2+	X1.2: Input I0+	X3.2: Input I2+
	X1.3: 0 V _{SEN}	X3.3: 0 V _{SEN}	X1.3: 0 V _{SEN}	X3.3: 0 V _{SEN}	X1.3: 0 V _{SEN}	X3.3: 0 V _{SEN}
	X1.4: Input U0-	X3.4: Input U1-	X1.4: Input 0-	X3.4: Input 2-	X1.4: Input I0-	X3.4: Input I2-
	X1.5: FE ²⁾	X3.5: FE ²⁾	X1.5: FE ²⁾	X3.5: FE ²⁾	X1.5: FE ²⁾	X3.5: FE ²⁾
	X2.1: 24 V _{SEN}	X4.1: 24 V _{SEN}	X2.1: 24 V _{SEN}	X4.1: 24 V _{SEN}	X2.1: 24 V _{SEN}	X4.1: 24 V _{SEN}
	X2.2: Input I0+	X4.2: Input I1+	X2.2: Input 1+	X4.2: Input 3+	X2.2: Input I1+	X4.2: Input I3+
	X2.3: 0 V _{SEN}	X4.3: 0 V _{SEN}	X2.3: 0 V _{SEN}	X4.3: 0 V _{SEN}	X2.3: 0 V _{SEN}	X4.3: 0 V _{SEN}
	X2.4: Input I0-	X4.4: Input I1-	X2.4: Input 1-	X4.4: Input 3-	X2.4: Input I1-	X4.4: Input I3-
	X2.5: FE ²⁾	X4.5: FE ²⁾	X2.5: FE ²⁾	X4.5: FE ²⁾	X2.5: FE ²⁾	X4.5: FE ²⁾

CPX-AB-8-KL-4POL

	X1.0: 24 V _{SEN}	X5.0: 24 V _{SEN}	X1.0: 24 V _{SEN}	X5.0: 24 V _{SEN}	X1.0: 24 V _{SEN}	X5.0: 24 V _{SEN}
	X1.1: 0 V _{SEN}	X5.1: 0 V _{SEN}	X1.1: 0 V _{SEN}	X5.1: 0 V _{SEN}	X1.1: 0 V _{SEN}	X5.1: 0 V _{SEN}
	X1.2: Input U0-	X5.2: Input U1-	X1.2: Input 0-	X5.2: Input 2-	X1.2: Input I0-	X5.2: Input I2-
	X1.3: FE	X5.3: FE	X1.3: FE	X5.3: FE	X1.3: FE	X5.3: FE
	X2.0: n.c.	X6.0: n.c.	X2.0: n.c.	X6.0: n.c.	X2.0: n.c.	X6.0: n.c.
	X2.1: n.c.	X6.1: n.c.	X2.1: n.c.	X6.1: n.c.	X2.1: n.c.	X6.1: n.c.
	X2.2: Input U0+	X6.2: Input U1+	X2.2: Input 0+	X6.2: Input 2+	X2.2: Input I0+	X6.2: Input I2+
	X2.3: FE	X6.3: FE	X2.3: FE	X6.3: FE	X2.3: FE	X6.3: FE
	X3.0: 24 V _{SEN}	X7.0: 24 V _{SEN}	X3.0: 24 V _{SEN}	X7.0: 24 V _{SEN}	X3.0: 24 V _{SEN}	X7.0: 24 V _{SEN}
	X3.1: 0 V _{SEN}	X7.1: 0 V _{SEN}	X3.1: 0 V _{SEN}	X7.1: 0 V _{SEN}	X3.1: 0 V _{SEN}	X7.1: 0 V _{SEN}
	X3.2: Input I0-	X7.2: Input I1-	X3.2: Input 1-	X7.2: Input 3-	X3.2: Input I1-	X7.2: Input I3-
	X3.3: FE	X7.3: FE	X3.3: FE	X7.3: FE	X3.3: FE	X7.3: FE
	X4.0: n.c.	X8.0: n.c.	X4.0: n.c.	X8.0: n.c.	X4.0: n.c.	X8.0: n.c.
	X4.1: n.c.	X8.1: n.c.	X4.1: n.c.	X8.1: n.c.	X4.1: n.c.	X8.1: n.c.
	X4.2: Input I0+	X8.2: Input I1+	X4.2: Input 1+	X8.2: Input 3+	X4.2: Input I1+	X8.2: Input I3+
	X4.3: FE	X8.3: FE	X4.3: FE	X8.3: FE	X4.3: FE	X8.3: FE

1) Speedcon quick lock, additional shielding on metal thread

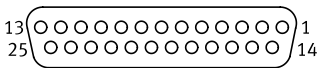

2) FE/shield additionally on metal thread

Data sheet – Input module, analogue

Pin allocation		CPX-2AE-U-I		CPX-4AE-U-I		CPX-4AE-I	
Connection block inputs		CPX-2AE-U-I		CPX-4AE-U-I		CPX-4AE-I	
CPX-AB-1-SUB-BU-25POL							
		1: Input U0-	14: Input U1-	1: Input 0-	14: Input 2-	1: Input I0-	14: Input I2-
		2: Input U0+	15: Input U1+	2: Input 0+	15: Input 2+	2: Input I0+	15: Input I2+
		3: Input I0-	16: Input I1-	3: Input 1-	16: Input 3-	3: Input I1-	16: Input I3-
		4: Input I1+	17: Input I1+	4: Input 1+	17: Input 3+	4: Input I1+	17: Input I3+
		5: n.c.	18: 24 V _{SEN}	5: n.c.	18: 24 V _{SEN}	5: n.c.	18: 24 V _{SEN}
		6: n.c.	19: n.c.	6: n.c.	19: n.c.	6: n.c.	19: n.c.
		7: n.c.	20: 24 V _{SEN}	7: n.c.	20: 24 V _{SEN}	7: n.c.	20: 24 V _{SEN}
		8: n.c.	21: n.c.	8: n.c.	21: n.c.	8: n.c.	21: n.c.
		9: 24 V _{SEN}	22: 0 V _{SEN}	9: 24 V _{SEN}	22: 0 V _{SEN}	9: 24 V _{SEN}	22: 0 V _{SEN}
		10: 24 V _{SEN}	23: 0 V _{SEN}	10: 24 V _{SEN}	23: 0 V _{SEN}	10: 24 V _{SEN}	23: 0 V _{SEN}
		11: 0 V _{SEN}	24: 0 V _{SEN}	11: 0 V _{SEN}	24: 0 V _{SEN}	11: 0 V _{SEN}	24: 0 V _{SEN}
		12: 0 V _{SEN}	25: FE	12: 0 V _{SEN}	25: FE	12: 0 V _{SEN}	25: FE
		13: Shielding ¹⁾	Housing: FE	13: Shielding ¹⁾	Housing: FE	13: Shielding ¹⁾	Housing: FE

1) Connect shield to functional earth FE

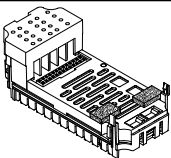
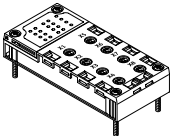
Data sheet – Input module, analogue

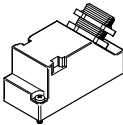
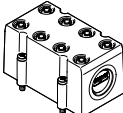
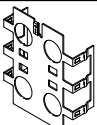
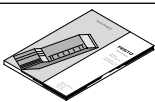
Ordering data		Part no.	Type	
Input module, analogue				
	2 analogue current or voltage inputs	526168	CPX-2AE-U-I	
	4 analogue current or voltage inputs	573710	CPX-4AE-U-I	
	4 analogue current inputs	541484	CPX-4AE-I	
Connection block				
	Plastic	4x socket M12, 5-pin	195704	CPX-AB-4-M12X2-5POL
		4x socket, M12 with quick-lock technology, 5-pin	541254	CPX-AB-4-M12X2-5POL-R
		Spring-loaded terminal, 32-pin	195708	CPX-AB-8-KL-4POL
	Metal	1x socket, Sub-D, 25-pin	525676	CPX-AB-1-SUB-BU-25POL
		4x socket M12, 5-pin	549367	CPX-M-AB-4-M12X2-5POL
Plug				
	Plug M12, 5-pin	175487	SEA-M12-5GS-PG7	
	Sub-D plug, 25-pin	527522	SD-SUB-D-ST25	
Cover				
	Cover for CPX-AB-8-KL-4POL (IP65, IP67)	538219	AK-8KL	
	<ul style="list-style-type: none"> • 8 cable through feeds M9 • 1 cable through feed for multi-pin plug Fittings kit	538220	VG-K-M9	
Screening plate				
	Screening plate for M12 connections	526184	CPX-AB-S-4-M12	
User documentation				
	User documentation	German	526415	P.BE-CPX-AX-DE
		English	526416	P.BE-CPX-AX-EN
		Spanish	526417	P.BE-CPX-AX-ES
		French	526418	P.BE-CPX-AX-FR
		Italian	526419	P.BE-CPX-AX-IT

Data sheet – Input module, analogue, with pressure sensors

Function

The pressure input modules make it possible to process a maximum of 4 pressures. The internal measured value of the sensor (analogue value with 10-bit resolution) is converted into an internal numerical format as appropriate to the parameterisation and made available to the bus node as a process image. It is additionally also possible to combine 2 channels in each case to form a differential pressure channel.

Area of application

- Measuring range: 0 ... 10 bar or –1 ... +1 bar
- Choice of units of measurement
- Processing a maximum of 4 pressures per module
- Pressure indication via LCD display
- Direct connection via QS4 push-in connectors
- Error message via CPX
- Channel-oriented diagnostics



General technical data			CPX-4AE-P-B2	CPX-4AE-P-D10
Type				
Number of analogue inputs			4	
Pneumatic connection			QS-4	
Nominal operating voltage	[V DC]		24	
Operating voltage range	[V DC]		18 ... 30	
Intrinsic current consumption	[mA]		Typically 50	
Measured variable			4 x relative or 2 x differential pressure measurement	
Displayable units			<ul style="list-style-type: none"> • kPa • mbar • psi 	
Pressure measuring range	Start value	[bar]	–1	0
	Final value	[bar]	1	10
Internal cycle time	[ms]		5	
Data format			<ul style="list-style-type: none"> • 15 bits + prefix • Binary notation in mbar, kPa, psi 	
LED displays			Group diagnostics	
Diagnostics			<ul style="list-style-type: none"> • Limit value violation per channel • Parameterisation error • Sensor limit per channel 	
Parameterisation			<ul style="list-style-type: none"> • Diagnostic delay per channel • Hysteresis per module • Unit of measurement • Measured value smoothing per channel • Limit value monitoring per channel • Sensor limit per channel • Measurement of relative/differential pressure 	
Degree of protection to EN 60529			IP65, IP67	
Operating medium			Compressed air to ISO 8573-1:2010 [7:4:4]	
Note on the operating/pilot medium			Lubricated operation possible (in which case lubricated operation will always be required)	
Ambient temperature	[°C]		–5 ... 50	
Storage temperature	[°C]		–20 ... 70	
Temperature of medium	[°C]		0 ... 50	
Note on materials			RoHS-compliant	
Materials			Reinforced PA, PC	
PWIS conformity			VDMA24364-B2-L	
Grid dimension	[mm]		50	
Dimensions (including interlinking block) W x L x H	[mm]		50 x 107 x 55	
Product weight	[g]		115	

 **Note**

Extreme pneumatic conditions, e.g. high cycle rate with high pressure amplitudes, can damage the sensors.

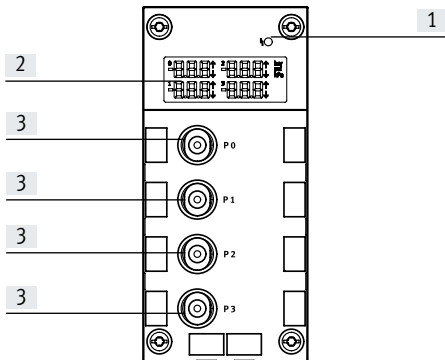

Data sheet – Input module, analogue, with pressure sensors

Connection and display components

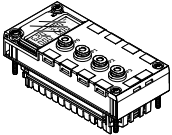
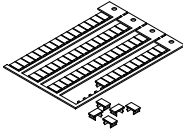

- [1] Error LED (red; module error)
- [2] LCD display with permanent display of the four measured pressures, unit of measurement and if applicable limit value violation
- [3] QS connections

Ordering data

Designation		Part no.	Type	
	4 analogue pressure inputs, pressure range -1 ... +1 bar	560361	CPX-4AE-P-B2	
	4 analogue pressure inputs, pressure range 0 ... 10 bar	560362	CPX-4AE-P-D10	
Inscription labels				
	Inscription labels 6x10 mm, 64 pieces, in frame	18576	IBS-6x10	
User documentation				
	User documentation	German	526415	P.BE-CPX-AX-DE
		English	526416	P.BE-CPX-AX-EN
		Spanish	526417	P.BE-CPX-AX-ES
		French	526418	P.BE-CPX-AX-FR
		Italian	526419	P.BE-CPX-AX-IT

Data sheet – Input module, analogue, for temperature inputs

Function

The CPX-PT100 analogue input module with 4 channels for temperature measurement enables the connection of up to 4 temperature sensors of the type PT100-PT1000, Ni100-Ni1000, etc. The temperature module supports various connection concepts with different numbers of sockets or terminals as appropriate to the connection block selected.

Area of application

- Temperature module for temperature sensors PT100, PT200, PT500, PT1000, Ni100, Ni120, Ni500, Ni1000
- Supports connection blocks with M12 and terminal connection
- Temperature module features can be parameterised
- 2-wire, 3-wire and 4-wire connection
- The temperature module is provided with voltage supply for the electronics and the sensors via the interlinking block
- Temperature module protection and diagnostics through integrated electronic fuse protection

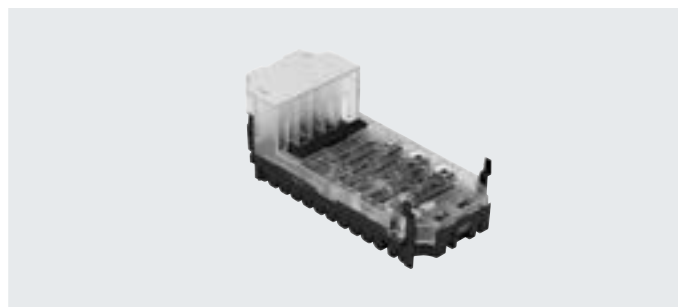

General technical data			
Type			CPX-4AE-T Temperature input
Number of analogue inputs			Choice of 2 or 4
Max. power supply per module	[A]		0.7
Fuse protection			Internal electronic fuse for sensor supply
Current consumption from 24 V sensor supply (quiescent current)	[mA]		Typically 50
Sensor supply voltage	[V DC]		24 ±25%
Sensor type (parameterisable for each channel with DIL switch)			PT100, PT200, PT500, PT1000 Ni100, Ni120, Ni500, Ni1000
Temperature range	Pt standard	[°C]	-200 ... +850
	Pt climatic	[°C]	-120 ... +130
	Ni	[°C]	-60 ... +180
Sensor connection technology			2-wire, 3-wire and 4-wire technology
Resolution			15 bits + prefix
Operating error limit relative to input range		[%]	±0.06
Basic error limit (25°C)	Standard	[K]	±0.6
	Pt climatic	[K]	±0.2
Temperature errors relative to input range		[%]	±0.001
Linearity errors (no software scaling)		[%]	±0.02
Repetition accuracy (at 25°C)		[%]	±0.05
Max. line resistance per conductor		[Ω]	10
Max. permissible input voltage		[V]	±30
Cycle time (module)		[ms]	≤ 250

Data sheet – Input module, analogue, for temperature inputs

General technical data		
Data format		15 bits + prefix, complement of two, binary notation in tenths of a degree
Cable length	[m]	Max. 200 (shielded)
Galvanic isolation	Channel – channel	No
	Channel – internal bus	Yes
LED displays	Group diagnostics	1
	Channel diagnostics	4
Diagnostics		<ul style="list-style-type: none"> • Short circuit/overload, channel • Parameterisation error • Value falling below nominal range/full-scale value • Value exceeding nominal range/full-scale value • Wire break
Parameterisation		<ul style="list-style-type: none"> • Unit of measurement and interference frequency suppression • Diagnostic message in the event of a wire break or short circuit • Limit monitoring per channel • Sensor connection technology • Sensor type/temperature coefficient, temperature range • Limit value per channel • Measured value smoothing
Degree of protection to EN 60529		Depending on connection block
Temperature range	Operation	[°C] -5 ... +50
	Storage/transport	[°C] -20 ... +70
Materials		Reinforced PA, PC
PWIS conformity		VDMA24364-B2-L
Grid dimension	[mm]	50
Dimensions (including interlinking block and connection block) W x L x H	[mm]	50 x 107 x 50
Product weight	[g]	47

Connection and display components

CPX-4AE-T

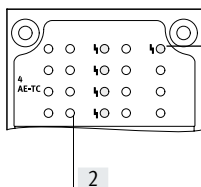

- [1] Error LED (red; module error)
- [2] Channel-related error LEDs (red)

Combinations of connection blocks and analogue module

Connection blocks	Part no.	Temperature module
		CPX-4AE-T
CPX-AB-4-M12X2-5POL	195704	■
CPX-AB-4-M12X2-5POL-R	541254	■
CPX-AB-8-KL-4POL	195708	■
CPX-M-AB-4-M12X2-5POL	549367	■



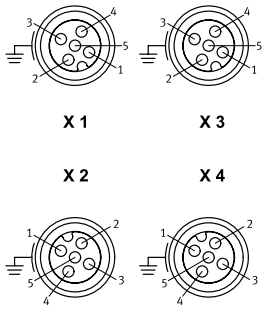
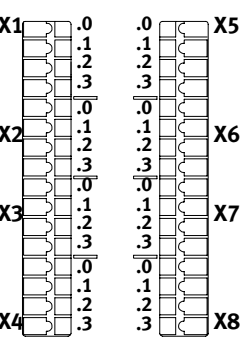

Data sheet – Input module, analogue, for temperature inputs

Pin allocation		CPX-4AE-T	
Connection block inputs		CPX-4AE-T	
CPX-AB-4-M12X2-5POL, CPX-AB-4-M12X2-5POL-R¹⁾ and CPX-M-AB-4-M12X2-5POL			
		X1.1: Input I0+ X1.2: Input U0+ X1.3: Input I0- X1.4: Input U0- X1.5: FE ²⁾ X2.1: Input I1+ X2.2: Input U1+ X2.3: Input I1- X2.4: Input U1- X2.5: FE ²⁾	X3.1: Input I2+ X3.2: Input U2+ X3.3: Input I2- X3.4: Input U2- X3.5: FE ²⁾ X4.1: Input I3+ X4.2: Input U3+ X4.3: Input I3- X4.4: Input U3- X4.5: FE ²⁾
CPX-AB-8-KL-4POL			
		X1.0: Input I0+ X1.1: Input I0- X1.2: Input U0- X1.3: FE X2.0: n.c. X2.1: n.c. X2.2: Input U0+ X2.3: FE X3.0: Input I1+ X3.1: Input I1- X3.2: Input U1- X3.3: FE X4.0: n.c. X4.1: n.c. X4.2: Input U1+ X4.3: FE	X5.0: Input I2+ X5.1: Input I2- X5.2: Input U2- X5.3: FE X6.0: n.c. X6.1: n.c. X6.2: Input U12+ X6.3: FE X7.0: Input I3+ X7.1: Input I3- X7.2: Input U3- X7.3: FE X8.0: n.c. X8.1: n.c. X8.2: Input U3+ X8.3: FE

1) Speedcon quick lock, additional shielding on metal thread

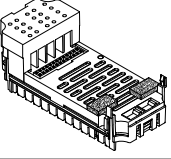
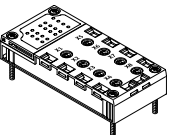
2) FE/shield additionally on metal thread

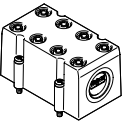
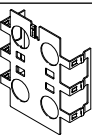
Data sheet – Input module, analogue, for temperature inputs

Ordering data		Part no.	Type	
Designation				
Input module, analogue				
	2 or 4 analogue temperature inputs	541486	CPX-4AE-T	
Connection block				
	Plastic	4x socket M12, 5-pin	195704	CPX-AB-4-M12X2-5POL
		4x socket, M12 with quick-lock technology, 5-pin	541254	CPX-AB-4-M12X2-5POL-R
		Spring-loaded terminal, 32-pin	195708	CPX-AB-8-KL-4POL
	Metal	4x socket M12, 5-pin	549367	CPX-M-AB-4-M12X2-5POL
Plug				
	Plug M12, 5-pin	175487	SEA-M12-5GS-PG7	
Cover				
	Cover for CPX-AB-8-KL-4POL (IP65, IP67)	538219	AK-8KL	
	<ul style="list-style-type: none"> • 8 cable through feeds M9 • 1 cable through feed for multi-pin plug Fittings kit	538220	VG-K-M9	
Screening plate				
	Screening plate for M12 connections	526184	CPX-AB-S-4-M12	
User documentation				
	User documentation	German	526415	P.BE-CPX-AX-DE
		English	526416	P.BE-CPX-AX-EN
		Spanish	526417	P.BE-CPX-AX-ES
		French	526418	P.BE-CPX-AX-FR
		Italian	526419	P.BE-CPX-AX-IT

Data sheet – Input module, analogue, for thermocouple

Function

The CPX-4AE-TC analogue input module with 4 channels for temperature measurement enables up to 4 thermocouple sensors to be connected.

The channels feature wire break and short circuit detection.

If no cold junction compensation sensor is being used, an internal theoretical value of 25°C can be used (accuracy is impaired).

Area of application

- Supports connection blocks with M12 and terminal connection
- Temperature module features can be parameterised
- 2-wire connection
- 2-wire connection for a PT1000 sensor for cold junction compensation
- The temperature module is provided with voltage supply for the electronics and the sensors via the interlinking block
- Temperature module protection and diagnostics through integrated electronic fuse protection

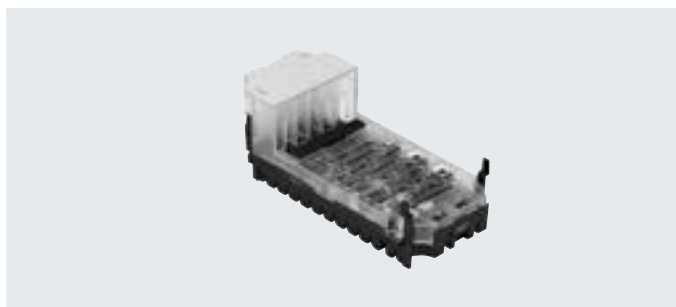

General technical data		CPX-4AE-TC
Type		Temperature input
Number of analogue inputs		4
Fuse protection (short circuit)		Internal electronic fuse per channel
Nominal operating voltage	[V DC]	24
Operating voltage range	[V DC]	18 ... 30
Sensor type (parameterisable for each channel with software)		<ul style="list-style-type: none"> • Type B +400 ... +1820°C, 8 iV/°C • Type E -270 ... +900°C, 60 iV/°C • Type J -200 ... +1200°C, 51 iV/°C • Type K -200 ... +1370°C, 40 iV/°C • Type N -200 ... +1300°C, 38 iV/°C • Type R 0 ... +1760°C, 12 iV/°C • Type S 0 ... +1760°C, 11 iV/°C • Type T -200 ... +400°C, 40 iV/°C
Sensor connection technology		2-wire technology
Operating error limit relative to ambient temperature	[%]	Max. ±0.6
Basic error limit (at 25°C)	[%]	Max. ±0.4
Repetition accuracy (at 25°C)	[%]	±0.05
Max. line resistance per conductor	[Ω]	10
Max. residual current per module	[mA]	30
Max. permissible input voltage	[V]	±30
Internal cycle time (module)	[ms]	250

Data sheet – Input module, analogue, for thermocouple

General technical data		
Data format		<ul style="list-style-type: none"> • 15 bits + prefix, complement of two • Binary notation in tenths of a degree
Cable length	[m]	Max. 50 (shielded)
Galvanic isolation	Channel – channel	No
	Channel – internal bus	Yes
LED displays	Group diagnostics	1
	Channel diagnostics	4
Diagnostics		<ul style="list-style-type: none"> • Parameterisation error • Wire break per channel • Limit value violation per channel
Parameterisation		<ul style="list-style-type: none"> • Monitoring of wire break per channel • Unit of measurement • Cold-junction compensation • Sensor type per channel • Limit value monitoring per channel • Measured value smoothing
Degree of protection to EN 60529		Depending on connection block
Temperature range	Operation	[°C] -5 ... +50
	Storage/transport	[°C] -20 ... +70
Materials		Reinforced PA, PC
PWIS conformity		VDMA24364-B2-L
Grid dimension	[mm]	50
Dimensions (including interlinking block and connection block) W x L x H	[mm]	50 x 107 x 50
Product weight	[g]	46

Connection and display components

CPX-4AE-TC

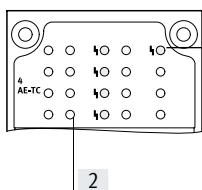

- [1] Error LED (red; module error)
- [2] Channel-related error LEDs (red)

Combinations of connection blocks and analogue module

Connection blocks	Part no.	Temperature module
		CPX-4AE-TC
CPX-AB-4-M12X2-5POL	195704	■
CPX-AB-4-M12X2-5POL-R	541254	■
CPX-AB-8-KL-4POL	195708	■
CPX-M-AB-4-M12X2-5POL	549367	■



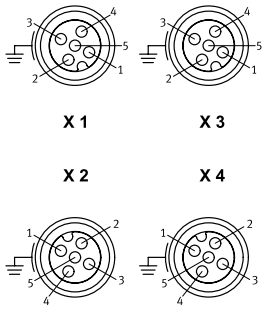
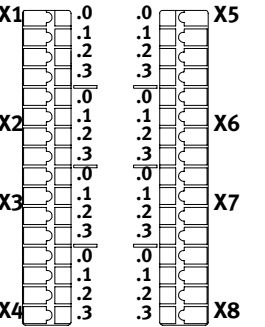

Data sheet – Input module, analogue, for thermocouple

Pin allocation		CPX-4AE-TC	
Connection block inputs			
CPX-AB-4-M12X2-5POL, CPX-AB-4-M12X2-5POL-R¹⁾ and CPX-M-AB-4-M12X2-5POL			
		X1.1: Cold junction compensation 0+ X1.2: Input signal U0+ X1.3: Cold junction compensation 0- X1.4: Input signal U0- X1.5: FE ²⁾ X2.1: Cold junction compensation 1+ X2.2: Input signal U1+ X2.3: Cold junction compensation 1- X2.4: Input signal U1- X2.5: FE ²⁾	X3.1: Cold junction compensation 2+ X3.2: Input signal U2+ X3.3: Cold junction compensation 2- X3.4: Input signal U2- X3.5: FE ²⁾ X4.1: Cold junction compensation 3+ X4.2: Input signal U3+ X4.3: Cold junction compensation 3- X4.4: Input signal U3- X4.5: FE ²⁾
CPX-AB-8-KL-4POL			
		X1.0: Cold junction compensation 0+ X1.1: Cold junction compensation 0- X1.2: Input signal U0- X1.3: FE X2.0: n.c. X2.1: n.c. X2.2: Input signal U0+ X2.3: FE X3.0: Cold junction compensation 1+ X3.1: Cold junction compensation 1- X3.2: Input signal U1- X3.3: FE X4.0: n.c. X4.1: n.c. X4.2: Input signal U1+ X4.3: FE	X5.0: Cold junction compensation 2+ X5.1: Cold junction compensation 2- X5.2: Input signal U2- X5.3: FE X6.0: n.c. X6.1: n.c. X6.2: Input signal U2+ X6.3: FE X7.0: Cold junction compensation 3+ X7.1: Cold junction compensation 3- X7.2: Input signal U3- X7.3: FE X8.0: n.c. X8.1: n.c. X8.2: Input signal U3+ X8.3: FE

1) Speedcon quick lock, additional shielding on metal thread

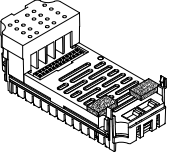
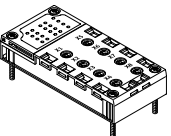
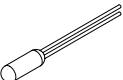
2) FE/shield additionally on metal thread

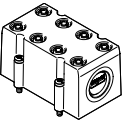
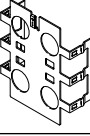
Data sheet – Input module, analogue, for thermocouple

Ordering data		Part no.	Type	
Designation				
Input module, analogue				
	4 analogue temperature inputs, with 2-wire connection for a PT1000 sensor for cold junction compensation	553594	CPX-4AE-TC	
Connection block				
	Plastic	4x socket M12, 5-pin	195704	CPX-AB-4-M12X2-5POL
		4x socket, M12 with quick-lock technology, 5-pin	541254	CPX-AB-4-M12X2-5POL-R
		Spring-loaded terminal, 32-pin	195708	CPX-AB-8-KL-4POL
	Metal	4x socket M12, 5-pin	549367	CPX-M-AB-4-M12X2-5POL
Cold junction compensation				
	PT1000 temperature sensor for cold junction compensation	553596	CPX-W-PT1000	
Plug				
	Plug M12, 5-pin	175487	SEA-M12-5GS-PG7	
Cover				
	Cover for CPX-AB-8-KL-4POL (IP65, IP67)	538219	AK-8KL	
	<ul style="list-style-type: none"> • 8 cable through feeds M9 • 1 cable through feed for multi-pin plug Fittings kit	538220	VG-K-M9	
Screening plate				
	Screening plate for M12 connections	526184	CPX-AB-S-4-M12	
User documentation				
	User documentation	German	526415	P.BE-CPX-AX-DE
		English	526416	P.BE-CPX-AX-EN
		Spanish	526417	P.BE-CPX-AX-ES
		French	526418	P.BE-CPX-AX-FR
		Italian	526419	P.BE-CPX-AX-IT

Data sheet – Output module, analogue

Function

Analogue modules control devices with a standard analogue interface such as proportional valves, etc.

Depending on the connection block selected, the analogue module supports various connection concepts with different numbers of sockets or terminals.

Area of application

- Analogue module for 0 ... 10 V, 0 ... 20 mA or 4 ... 20 mA
- Supports connection blocks with Sub-D, terminal connection and M12 connection
- Analogue module features can be parameterised
- Different data formats available
- Operation with and without galvanic isolation possible
- The analogue module receives the voltage supply for the electronics and the actuators from the interlinking block
- Analogue module protection and diagnostics through integrated electronic fuse protection



General technical data			CPX-2AA-U-I	
Type			Voltage output	Current output
Number of analogue outputs			2	
Max. actuator supply per module [A]			2.8	
Fuse protection			Internal electronic fuse for actuator supply	
Current consumption from 24 V sensor supply (at full load) [mA]			Max. 150	
Current consumption from 24 V actuator supply (at full load) [A]			4 ... 10	
Supply voltage for actuators [V DC]			24 ±25%	
Signal range (parameterisable for each channel with DIL switch or software)			0 ... 10 V DC	0 ... 20 mA 4 ... 20 mA
Resolution [bit]			12	
Number of units			4096	
Absolute accuracy [%]			±0.6	
Linearity errors (no software scaling) [%]			±0.1	
Repetition accuracy (at 25°C) [%]			0.05	
Encoder selection	Load resistance for ohmic load [kΩ]		Min. 1	Max. 0.5
	Load resistance for capacitive load [μF]		Max. 1	–
	Load resistance for inductive load [mH]		–	Max. 1
	Short circuit protection for analogue output		Yes	–
	Short circuit current of analogue output [mA]		Approx. 20	–
	Open circuit voltage [V DC]		–	18
	Destruction limit against externally applied voltage [V DC]		15	
Actuator connection			2 wires	
Cycle time (module) [ms]			≤ 4	

Data sheet – Output module, analogue

General technical data			CPX-2AA-U-I	
Type			Voltage output	Current output
Response time	For ohmic load	[ms]	0.1	0.1
	For capacitive load	[ms]	0.7	–
	For inductive load	[ms]	–	0.5
Data format	15 bits + prefix, linear scaling 12 bits right-justified 12 bits left-justified, S7 compatible 12 bits left-justified, S5 compatible			
Cable length	[m]	Max. 30 (shielded)		
LED displays	Group diagnostics	1		
	Channel diagnostics	Yes, via flashing frequency of group diagnostics		
Diagnostics	<ul style="list-style-type: none"> • Short circuit/overload, actuator supply • Parameterisation error • Value falling below nominal range/full-scale value • Value exceeding nominal range/full-scale value • Wire break 			
Parameterisation	<ul style="list-style-type: none"> • Short circuit monitoring, actuator supply • Short circuit monitoring, analogue output • Behaviour after short circuit, actuator supply • Data format • Lower limit value/full-scale value • Upper limit value/full-scale value • Monitoring value falling below nominal range/full-scale value • Monitoring value exceeding nominal range/full-scale value • Monitoring wire break • Signal range 			
Degree of protection to EN 60529	Depending on connection block			
Temperature range	Operation	[°C]	–5 ... +50	
	Storage/transport	[°C]	–20 ... +70	
Materials	Reinforced PA, PC			
PWIS conformity	VDMA24364-B2-L			
Grid dimension	[mm]	50		
Dimensions (including interlinking block and connection block) W x L x H	[mm]	50 x 107 x 50		
Product weight	[g]	49		

Connection and display components

CPX-2AA-U-I

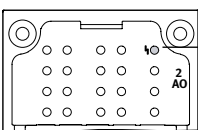

[1] Error LED (red; module error)

Combinations of connection blocks and analogue module

Connection blocks	Part no.	Analogue module
		CPX-2AA-U-I
CPX-AB-4-M12X2-5POL	195704	■
CPX-AB-4-M12X2-5POL-R	541254	■
CPX-AB-8-KL-4POL	195708	■
CPX-AB-1-SUB-BU-25POL	525676	■
CPX-M-AB-4-M12X2-5POL	549367	■

Data sheet – Output module, analogue

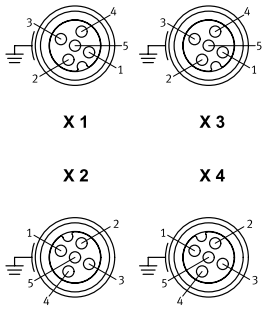
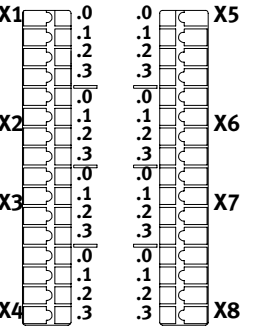
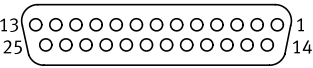



Pin allocation		CPX-2AA-U-I
Connection block outputs		
CPX-AB-4-M12X2-5POL, CPX-AB-4-M12X2-5POL-R¹⁾, CPX-M-AB-4-M12X2-5POL		
 <p>X 1 X 3</p> <p>X 2 X 4</p>	<p>X1.1: 24 V_{OUT}</p> <p>X1.2: Output U0+</p> <p>X1.3: 0 V_{OUT}</p> <p>X1.4: Output GND</p> <p>X1.5: FE²⁾</p> <p>X2.1: 24 V_{OUT}</p> <p>X2.2: Output I0+</p> <p>X2.3: 0 V_{OUT}</p> <p>X2.4: Output GND</p> <p>X2.5: FE²⁾</p>	<p>X3.1: 24 V_{OUT}</p> <p>X3.2: Output U1+</p> <p>X3.3: 0 V_{OUT}</p> <p>X3.4: Output GND</p> <p>X3.5: FE²⁾</p> <p>X4.1: 24 V_{OUT}</p> <p>X4.2: Output I1+</p> <p>X4.3: 0 V_{OUT}</p> <p>X4.4: Output GND</p> <p>X4.5: FE²⁾</p>
CPX-AB-8-KL-4POL		
 <p>X1 .0 .0 X5</p> <p> .1 .1</p> <p> .2 .2</p> <p> .3 .3</p> <p>X2 .0 .0 X6</p> <p> .1 .1</p> <p> .2 .2</p> <p> .3 .3</p> <p>X3 .0 .0 X7</p> <p> .1 .1</p> <p> .2 .2</p> <p> .3 .3</p> <p>X4 .0 .0 X8</p> <p> .1 .1</p> <p> .2 .2</p> <p> .3 .3</p>	<p>X1.0: 24 V_{OUT}</p> <p>X1.1: 0 V_{OUT}</p> <p>X1.2: Output GND</p> <p>X1.3: FE</p> <p>X2.0: n.c.</p> <p>X2.1: n.c.</p> <p>X2.2: Output U0+</p> <p>X2.3: FE</p> <p>X3.0: 24 V_{OUT}</p> <p>X3.1: 0 V_{OUT}</p> <p>X3.2: Output GDN</p> <p>X3.3: FE</p> <p>X4.0: n.c.</p> <p>X4.1: n.c.</p> <p>X4.2: Output I0+</p> <p>X4.3: FE</p>	<p>X5.0: 24 V_{OUT}</p> <p>X5.1: 0 V_{OUT}</p> <p>X5.2: Output GND</p> <p>X5.3: FE</p> <p>X6.0: n.c.</p> <p>X6.1: n.c.</p> <p>X6.2: Output U1+</p> <p>X6.3: FE</p> <p>X7.0: 24 V_{OUT}</p> <p>X7.1: 0 V_{OUT}</p> <p>X7.2: Output GND</p> <p>X7.3: FE</p> <p>X8.0: n.c.</p> <p>X8.1: n.c.</p> <p>X8.2: Output I1+</p> <p>X8.3: FE</p>
CPX-AB-1-SUB-BU-25POL		
	<p>1: Output GND</p> <p>2: Output U0+</p> <p>3: Output GND</p> <p>4: Output I0+</p> <p>5: n.c.</p> <p>6: n.c.</p> <p>7: n.c.</p> <p>8: n.c.</p> <p>9: 24 V_{OUT}</p> <p>10: 24 V_{OUT}</p> <p>11: 0 V_{OUT}</p> <p>12: 0 V_{OUT}</p> <p>13: Shielding³⁾</p>	<p>14: Output GND</p> <p>15: Output U1+</p> <p>16: Output GND</p> <p>17: Output I1+</p> <p>18: 24 V_{OUT}</p> <p>19: n.c.</p> <p>20: 24 V_{OUT}</p> <p>21: n.c.</p> <p>22: 0 V_{OUT}</p> <p>23: 0 V_{OUT}</p> <p>24: 0 V_{OUT}</p> <p>25: FE</p> <p>Housing: FE</p>

1) Speedcon quick lock, additional shielding on metal thread

2) FE/shield additionally on metal thread

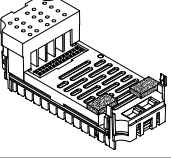
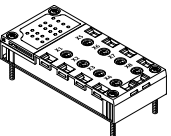
3) Connect shield to functional earth FE

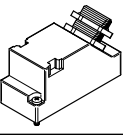
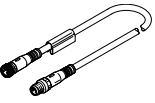
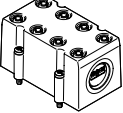
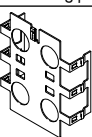
Data sheet – Output module, analogue

Ordering data		Part no.	Type
Designation			
Output module, analogue			
	2 analogue current or voltage outputs	526170	CPX-2AA-U-I
Connection block			
	Plastic	4x socket M12, 5-pin	195704 CPX-AB-4-M12X2-5POL
		4x socket, M12 with quick-lock technology, 5-pin	541254 CPX-AB-4-M12X2-5POL-R
		Spring-loaded terminal, 32-pin	195708 CPX-AB-8-KL-4POL
	Metal	1x socket, Sub-D, 25-pin	525676 CPX-AB-1-SUB-BU-25POL
		4x socket M12, 5-pin	549367 CPX-M-AB-4-M12X2-5POL
Plug			
	Plug M12, 5-pin	175487	SEA-M12-5GS-PG7
	Sub-D plug, 25-pin	527522	SD-SUB-D-ST25
Connecting cable			
	Modular system for a choice of connecting cables	–	NEBU-... → Internet: nebu
Cover			
	Cover for CPX-AB-8-KL-4POL (IP65, IP67)	538219	AK-8KL
	<ul style="list-style-type: none"> • 8 cable through feeds M9 • 1 cable through feed for multi-pin plug Fittings kit	538220	VG-K-M9
Screening plate			
	Screening plate for M12 connections	526184	CPX-AB-S-4-M12
User documentation			
	User documentation	German	526415 P.BE-CPX-AX-DE
		English	526416 P.BE-CPX-AX-EN
		Spanish	526417 P.BE-CPX-AX-ES
		French	526418 P.BE-CPX-AX-FR
		Italian	526419 P.BE-CPX-AX-IT

Data sheet – PROFIsafe shut-off module

Function

The PROFIsafe shut-off module interrupts the contact rails of the interlinking block for valves and outputs. The supply voltage for valves can be switched by the module within the CPX terminal and via a connection block to two consuming devices. Actuation takes place via the bus node (PROFINET) of the CPX terminal.

Area of application

- Output module for 24 V DC supply voltage
- Shut-off module for supply voltage for valves
- Can only be used with PROFINET or PROFIBUS bus nodes
- The shut-off module is supplied with voltage for the electronics and the outputs by the interlinking block
- The outputs are supplied from the power supply for valves (V_{Valves})

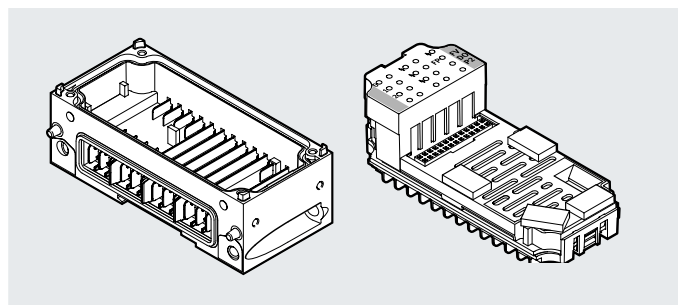

General technical data			CPX-FVDA-P2
Type			CPX-FVDA-P2
Number of outputs			2
Note on outputs			1 internal channel for switching off the supply voltage for valves 2 external outputs
Max. address capacity	Inputs	[B]	6
	Outputs	[B]	6
Maximum cable length			200
Max. power supply	Per module	[A]	5
	Per channel	[A]	1.5
Fuse protection (short circuit)			Internal electronic fuse per channel
Current consumption of module			Typically 65 (power supply for valves)
			Typically 25 (power supply for electronics)
Operating voltage	Nominal value	[V DC]	24
	Permissible range	[V DC]	20.4 ... 28.8
Voltage drop per channel			0.6
Residual ripple			2 within voltage range
Load capacity to FE			400
Max. response time to shut-off command			23
Galvanic isolation	Channel – channel		No
	Channel – internal bus		Yes, with intermediate supply
Switching logic	Outputs		P-M switching
Safety integrity level			Safe switch-off, SIL3
Performance Level			Safe switch-off/category 3, Performance Level e
Failure rate per hour (PFH)			1.0×10^{-9}
Certificate issuing authority			TÜV Rhld 01/205/5294.02/23
			TÜV Rhld 01/205U/5294.01/23
LED displays	Group diagnostics		1
	Channel diagnostics		3
	Channel status		3
	Failsafe protocol active		1
Diagnostics			<ul style="list-style-type: none"> • Short circuit/overload per channel • Undervoltage of valves • Cross circuit • Wire break per channel
Parameterisation			<ul style="list-style-type: none"> • Monitoring of wire break per channel • Diagnostic behaviour
Degree of protection to EN 60529			Depending on connection block
Grid dimension	[mm]		50
Dimensions (including interlinking block and connection block) W x L x H	[mm]		50 x 107 x 55
Product weight	[g]		50

Data sheet – PROFIsafe shut-off module

Materials	
Housing	Reinforced PA, PC
Note on materials	RoHS-compliant
PWIS conformity	VDMA24364-B2-L

Operating and environmental conditions	
Ambient temperature	[°C] -5 ... +50
Storage temperature	[°C] -20 ... +70
CE marking (see declaration of conformity) ¹⁾	To EU Machinery Directive
	To EU EMC Directive
	To EU RoHS Directive
UKCA marking (see declaration of conformity) ¹⁾	To UK instructions for machines
	To UK instructions for EMC
	To UK RoHS instructions
Certification	c UL us - Recognized (OL)

1) Additional information at: www.festo.com/catalogue/... → Support/Downloads.

Connection and display components

CPX-FVDA-P2

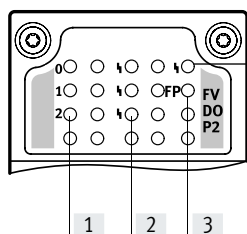

- [1] Status LEDs (yellow):
 - 0: Supply voltage for valves
 - 1: X1
 - 2: X2
- [2] Channel-related error LEDs (red)
- [3] Fail-safe protocol active (green)
- [4] Error LED (red, module error)

Combinations of bus nodes/control blocks and PROFIsafe shut-off module

Bus node/control block	Part no.	PROFIsafe shut-off module
		CPX-FVDA-P2
CPX-FB13	195740	■
CPX-FB43	8110369	■
CPX-M-FB44	8110370	■
CPX-M-FB45	8110371	■

Note
 The PROFIsafe shut-off module CPX-FVDA-P2 can only be integrated as of software release 21 or release 30 (in the case of CPX-FB13).

Data sheet – PROFIsafe shut-off module

Combinations of connection blocks and PROFIsafe shut-off module		
Connection blocks	Part no.	PROFIsafe shut-off module
		CPX-FVDA-P2
CPX-M-AB-4-M12X2-5POL	549367	■
CPX-AB-8-KL-4POL	195708	■

Pin allocation	
Connection block outputs	CPX-FVDA-P2

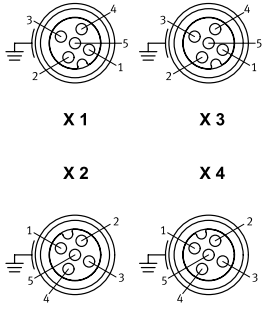
CPX-M-AB-4-M12X2-5POL		
	<p>X1.1: 0 V_{OUT} 1 (cannot be switched off)</p> <p>X1.2: 24 V_{OUT} 1 (cannot be switched off)</p> <p>X1.3: 0 V_{OUT} 1 (can be switched off via fieldbus)</p> <p>X1.4: 24 V_{OUT} 1 (can be switched off via fieldbus)</p> <p>X1.5: FE</p> <p>X2.1: 0 V_{OUT} 2 (cannot be switched off)</p> <p>X2.2: 24 V_{OUT} 2 (cannot be switched off)</p> <p>X2.3: 0 V_{OUT} 2 (can be switched off via fieldbus)</p> <p>X2.4: 24 V_{OUT} 2 (can be switched off via fieldbus)</p> <p>X2.5: FE</p>	<p>X3.1: n.c.</p> <p>X3.2: n.c.</p> <p>X3.3: n.c.</p> <p>X3.4: n.c.</p> <p>X3.5: FE</p> <p>X4.1: n.c.</p> <p>X4.2: n.c.</p> <p>X4.3: n.c.</p> <p>X4.4: n.c.</p> <p>X4.5: FE</p>

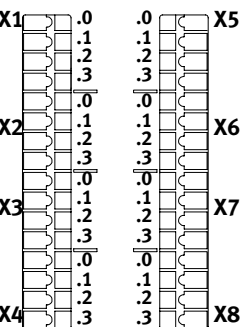
CPX-AB-8-KL-4POL		
	<p>X1.0: 0 V_{OUT} 1 (cannot be switched off)</p> <p>X1.1: 0 V_{OUT} 1 (can be switched off via fieldbus)</p> <p>X1.2: 24 V_{OUT} 1 (can be switched off via fieldbus)</p> <p>X1.3: FE</p> <p>X2.0: n.c.</p> <p>X2.1: n.c.</p> <p>X2.2: 24 V_{OUT} 1 (cannot be switched off)</p> <p>X2.3: FE</p> <p>X3.0: 0 V_{OUT} 2 (cannot be switched off)</p> <p>X3.1: 0 V_{OUT} 2 (can be switched off via fieldbus)</p> <p>X3.2: 24 V_{OUT} 2 (can be switched off via fieldbus)</p> <p>X3.3: FE</p> <p>X4.0: n.c.</p> <p>X4.1: n.c.</p> <p>X4.2: 24 V_{OUT} 2 (cannot be switched off)</p> <p>X4.3: FE</p>	<p>X5.0: n.c.</p> <p>X5.1: n.c.</p> <p>X5.2: n.c.</p> <p>X5.3: n.c.</p> <p>X6.0: n.c.</p> <p>X6.1: n.c.</p> <p>X6.2: n.c.</p> <p>X6.3: n.c.</p> <p>X7.0: n.c.</p> <p>X7.1: n.c.</p> <p>X7.2: n.c.</p> <p>X7.3: n.c.</p> <p>X8.0: n.c.</p> <p>X8.1: n.c.</p> <p>X8.2: n.c.</p> <p>X8.3: n.c.</p>



Data sheet – PROFIsafe shut-off module

Combinations of interlinking blocks and PROFIsafe shut-off module		
Interlinking blocks	Part no.	PROFIsafe shut-off module
		CPX-FVDA-P2
CPX-GE-EV-S	195746	-
CPX-GE-EV-S-VL	8022170	-
CPX-GE-EV-S-7/8-4POL	541248	-
CPX-GE-EV-S-7/8-5POL	541244	-
CPX-GE-EV-S-7/8-5POL-VL	8022172	-
CPX-M-GE-EV-S-7/8-CIP-4P	568956	-
CPX-M-GE-EV-S-7/8-5POL	550208	-
CPX-M-GE-EV-S-7/8-5POL-VL	8022165	-
CPX-M-GE-EV-S-M12-5POL	8098392	-
CPX-M-GE-EV-S-PP-5POL	563057	-
CPX-GE-EV	195742	-
CPX-M-GE-EV	550206	-
CPX-M-GE-EV-FVO	567806	■
CPX-GE-EV-Z	195744	-
CPX-GE-EV-Z-VL	8022166	-
CPX-GE-EV-Z-7/8-4POL	541250	-
CPX-GE-EV-Z-7/8-5POL	541246	-
CPX-GE-EV-Z-7/8-5POL-VL	8022173	-
CPX-M-GE-EV-Z-7/8-5POL	550210	-
CPX-M-GE-EV-Z-7/8-5POL-VL	8022158	-
CPX-M-GE-EV-Z-PP-5POL	563058	-
CPX-GE-EV-V	533577	-
CPX-GE-EV-V-VL	8022171	-
CPX-GE-EV-V-7/8-4POL	541252	-
CPX-M-GE-EV-W-M12-5POL	8098391	-

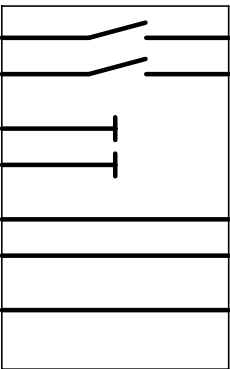
General technical data		
Type		CPX-M-GE-EV-FVO
Nominal operating voltage	[V DC]	24
Acceptable current load (per contact/contact rail)	[A]	16
Degree of protection to EN 60529		Depending on connection block
Ambient temperature	[°C]	-5 ... +50
Certification		c UL us - Recognized (OL)
Note on materials		RoHS-compliant
Materials		Die-cast aluminium
PWIS conformity		VDMA24364-B2-L
Type of mounting		Angled fitting
Grid dimension	[mm]	50
Dimensions W x L x H	[mm]	50 x 107 x 35
Product weight	[g]	170

Pin allocation			
Circuitry		Pin	Allocation
 <p>0V Valves 24V Valves 0V Output 24V Output 0V El./Sen. 24V El./Sen. FE</p>		-	-
		-	-
		-	-
		-	-

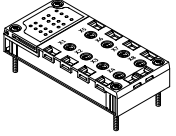
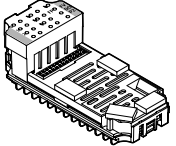
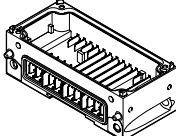
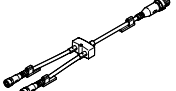
Data sheet – PROFIsafe shut-off module

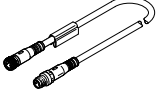
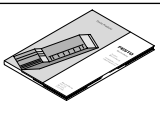
Ordering data		Description	Part no.	Type
PROFIsafe shut-off module				
	Metal connection block	4x socket, M12, 5-pin	549367	CPX-M-AB-4-M12X2-5POL
	Plastic connection block	Spring-loaded terminal, 32-pin	195708	CPX-AB-8-KL-4POL
	Electronics module (can only be used with CPX-M-GE-EV-FVO)	PROFINET, PROFIBUS	1971599	CPX-FVDA-P2
	Metal interlinking block (for CPX-FVDA-P2 only)		567806	CPX-M-GE-EV-FVO
Distributor				
	Modular system for all types of sensor/actuator distributor		–	NEDY... → Internet: nedy
	1x plug M12, 4-pin	2x socket M12, 5-pin	8005310	NEDY-L2R1-V1-M12G5-N-M12G4
Plug				
	Plug	M12, PG7	18666	SEA-GS-7
		M12, PG7, 4-pin for cable \varnothing 2.5 mm	192008	SEA-4GS-7-2.5
		M12, PG9	18778	SEA-GS-9
		M12 for 2 cables	18779	SEA-GS-11-DUO
		M12 for 2 cables, 5-pin	192010	SEA-5GS-11-DUO
		M12, 5-pin	175487	SEA-M12-5GS-PG7
Connecting cable				
	Modular system for a choice of connecting cables		–	NEBU... → Internet: nebu
User documentation				
	User documentation for PROFIsafe shut-off module	German	8022606	CPX-FVDA-P2-DE
		English	8022607	CPX-FVDA-P2-EN
		Spanish	8022608	CPX-FVDA-P2-ES
		French	8022609	CPX-FVDA-P2-FR
		Italian	8022610	CPX-FVDA-P2-IT
		Chinese	8022611	CPX-FVDA-P2-ZH

Data sheet – End plate with system supply

Function

End plates form the outer edge of the CPX terminal.

The earth connection and mounting holes for wall or H-rail mounting are located on the left-hand end plate.

The end plate with system supply has contact rails from which the other CPX components on the interlinking modules are supplied with power.

Area of application

- 24 V DC supply voltage for the electronics of the CPX terminal
- 24 V DC supply voltage for inputs
- 24 V DC supply voltage for valves
- 24 V DC supply voltage for outputs

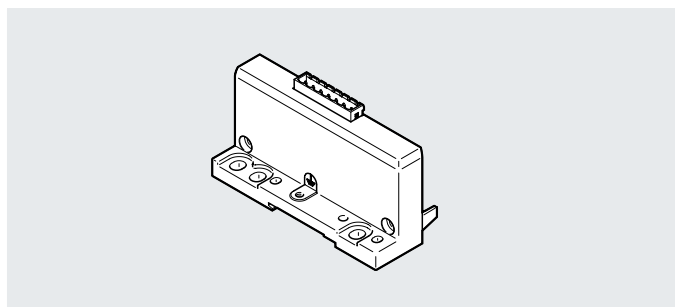

General technical data		
Electrical connection		Plug, 7-pin
Type of mounting		Tie rods
Power supply		System supply
Maximum power supply	[A]	12
Product weight	[g]	145

Materials	
Housing	Die-cast aluminium, painted
Note on materials	RoHS-compliant
PWIS conformity	VDMA24364-B2-L

Operating and environmental conditions	
Certification	c UL us - Recognized (OL)

Pin allocation		
Circuitry	Pin	Allocation
Plug, 7-pin		
	[1]	0 V power supply for valves
	[2]	24 V DC load voltage supply for valves
	[3]	0 V power supply for outputs
	[4]	24 V DC load voltage supply for outputs
	[5]	0 V power supply for electronics and sensors
	[6]	24 V DC power supply for electronics and sensors
	[7]	FE

Data sheet – End plate with system supply

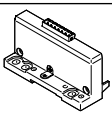
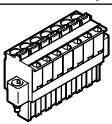
Ordering data		Part no.	Type
End plate with system supply			
	End plate for CPX terminal in plastic design	576315	CPX-EPL-EV-S
Terminal strip			
	Plug, 7-pin, straight	Spring-loaded terminal 576319	NECU-L3G7-C1

Data sheet – End plate with extension

Function

End plates form the outer edge of the CPX terminal.
 The earth connection and mounting holes for wall or H-rail mounting are located on the left-hand end plates.
 The end plates with extension enable the CPX terminal to be separated into two interconnected terminals. Control is provided via a common bus node or control block.

Area of application

- Separation of long CPX terminals into two shorter units
- Adaptation for installation in a control cabinet

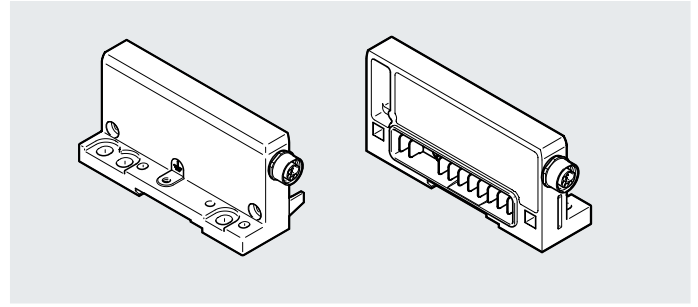

General technical data		
Type	CPX-EP..	CPX-M-EP..
Type of mounting	Tie rods	Angled fitting
Maximum power supply	[A] 6	6
Materials		
Type	CPX-EP..	CPX-M-EP..
Housing	Die-cast aluminium, painted	Die-cast aluminium
Note on materials	RoHS-compliant	RoHS-compliant
PWIS conformity	VDMA24364-B2-L	VDMA24364-B2-L
Operating and environmental conditions		
Certification	c UL us - Recognized (OL)	

Data sheet – End plate with extension

Pin allocation – End plate with extension				
Circuitry	Pin	Allocation	Pin	Circuitry
Right-hand end plate (first row)	Round plug, 8-pin			Left-hand end plate (second row)
	M12			
	1	0 V DC supply voltage for electronics and sensors	1	
	2	0 V DC load voltage supply for valves	2	
	3	24 V DC load voltage supply for valves	3	
	4	24 V DC power supply for electronics and sensors	4	
	5	Bus signal	5	
	6	Bus signal	6	
	7	Bus signal	7	
	8	Bus signal	8	
	Housing	FE	Housing	

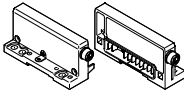
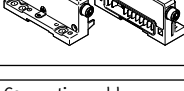
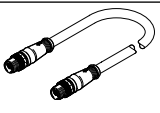
Ordering data					
			Weight [g]	Part no.	Type
End plate with extension					
	For CPX terminal in plastic design	First row, right-hand end plate	190	576313	CPX-EPR-EV-X
		Second row, left-hand end plate	175	576314	CPX-EPL-EV-X
	For CPX terminal in metal design	First row, right-hand end plate	190	576316	CPX-M-EPR-EV-X
		Second row, left-hand end plate	175	576317	CPX-M-EPL-EV-X
Connecting cable					
	8-pin	0.25 m	47	564189	NEBC-F12G8-KH-0.25-N-S-F12G8
		0.5 m	69	564190	NEBC-F12G8-KH-0.5-N-S-F12G8
		1 m	113	564191	NEBC-F12G8-KH-1-N-S-F12G8
		1.5 m	154	564192	NEBC-F12G8-KH-1.5-N-S-F12G8
		2 m	200	576015	NEBC-F12G8-KH-2-N-S-F12G8
		3 m	280	576636	NEBC-F12G8-KH-3-N-S-F12G8

Data sheet – Interlinking block with system supply

Function

Interlinking blocks ensure the electrical supply of all other CPX modules. They have contact rails, from which the other CPX components on the interlinking modules are supplied with power. Internal division of the power supply makes it possible to switch off specific areas of the sensors and actuators individually.

Area of application

- 24 V DC supply voltage for the electronics of the CPX terminal
- 24 V DC supply voltage for inputs
- 24 V DC supply voltage for valves
- 24 V DC supply voltage for outputs



General technical data		
Nominal operating voltage	[V DC]	24
Degree of protection to EN 60529		Depending on connection block
Ambient temperature	[°C]	-5 ... +50
Note on materials		RoHS-compliant
PWIS conformity		VDMA24364-B2-L
Grid dimension	[mm]	50
Dimensions W x L x H	[mm]	50 x 107 x 35

Technical data – Plastic interlinking blocks			CPX-GE-EV-S				
Type				-VL	-7/8-4POL	-7/8-5POL	-7/8-5POL-VL
Electrical connection			M18	M18	7/8", 4-pin	7/8", 5-pin	7/8", 5-pin
Power supply	Sensors and electronics	[A]	Max. 16	Max. 8	Max. 10	Max. 8	Max. 8
	Valves and outputs	[A]	Max. 16	Max. 8	Max. 10	Max. 8	Max. 8
Corrosion resistance class CRC ¹⁾			1				
Type of mounting			Tie rods				
Materials			PA-reinforced				
Product weight	[g]		125				

1) Additional information: www.festo.com/x/topic/kbk

Data sheet – Interlinking block with system supply

Technical data – Metal interlinking blocks		CPX-M-GE-EV-S				
		-7/8-CIP-4P	-7/8-5POL	-M12-5POL	-7/8-5POL-VL	-PP-5POL
Type						
Electrical connection		7/8", 4-pin	7/8", 5-pin	Plug	7/8", 5-pin	AIDA push-pull, 5-pin
				M12x1		
				5-pin		
				L-coded		
Power supply	Sensors and electronics [A]	Max. 10	Max. 8	Max. 16	Max. 8	Max. 16
	Valves and outputs [A]	Max. 10	Max. 8	Max. 16	Max. 8	Max. 16
Corrosion resistance class CRC ¹⁾		0				
Type of mounting		Angled fitting				
Materials		Die-cast aluminium				
Certification		–	–	c UL - Recognized (OL)	–	–
Product weight [g]		187	187	266	187	279

1) Additional information: www.festo.com/x/topic/kbk

**Note**

Points to note about the interlinking block CPX-M-GE-EV-S-7/8-CIP-4P:

- Must be mounted as the first module to the right of the left-hand end plate
- The functional earth (FE) must be connected via the left-hand end plate
- Only permitted as an interlinking block to a bus node

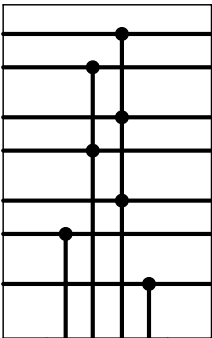
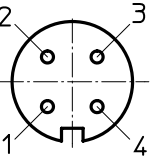
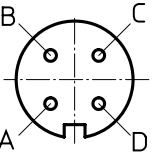

Data sheet – Interlinking block with system supply

Pin allocation – Plastic interlinking blocks

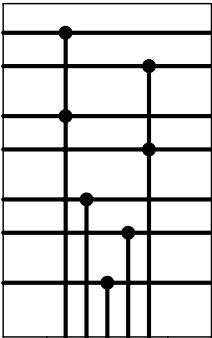
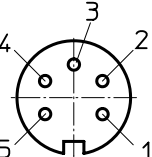
Circuitry	Pin	Allocation																							
Round plug, 4-pin																									
 <p>0V Valves 24V Valves 0V Output 24V Output 0V El./Sen. 24V El./Sen. FE</p>	<p>M18</p> 	<table border="1"> <tr><td>1</td><td>24 V DC power supply for electronics and sensors</td></tr> <tr><td>2</td><td>24 V DC load voltage supply for valves and outputs</td></tr> <tr><td>3</td><td>0 V</td></tr> <tr><td>4</td><td>FE</td></tr> </table>	1	24 V DC power supply for electronics and sensors	2	24 V DC load voltage supply for valves and outputs	3	0 V	4	FE															
	1	24 V DC power supply for electronics and sensors																							
2	24 V DC load voltage supply for valves and outputs																								
3	0 V																								
4	FE																								
<table border="1"> <tr><td>M18</td><td>1</td><td>2</td><td>3</td><td>4</td></tr> <tr><td>7/8"</td><td>A</td><td>B</td><td>D</td><td>C</td></tr> <tr><td></td><td>24V</td><td>24V</td><td>0V</td><td>FE</td></tr> </table>	M18	1	2	3	4	7/8"	A	B	D	C		24V	24V	0V	FE	<p>7/8"</p> 	<table border="1"> <tr><td>A</td><td>24 V DC supply voltage for electronics and sensors</td></tr> <tr><td>B</td><td>24 V DC load voltage supply for valves and outputs</td></tr> <tr><td>C</td><td>FE</td></tr> <tr><td>D</td><td>0V</td></tr> </table>	A	24 V DC supply voltage for electronics and sensors	B	24 V DC load voltage supply for valves and outputs	C	FE	D	0V
M18	1	2	3	4																					
7/8"	A	B	D	C																					
	24V	24V	0V	FE																					
A	24 V DC supply voltage for electronics and sensors																								
B	24 V DC load voltage supply for valves and outputs																								
C	FE																								
D	0V																								

Round plug, 5-pin														
 <p>0V Valves 24V Valves 0V Output 24V Output 0V El./Sen. 24V El./Sen. FE</p>	<p>7/8"</p> 	<table border="1"> <tr><td>1</td><td>0 V valves and outputs</td></tr> <tr><td>2</td><td>0 V electronics and sensors</td></tr> <tr><td>3</td><td>FE</td></tr> <tr><td>4</td><td>24 V DC power supply for electronics and sensors</td></tr> <tr><td>5</td><td>24 V DC load voltage supply for valves and outputs</td></tr> </table>	1	0 V valves and outputs	2	0 V electronics and sensors	3	FE	4	24 V DC power supply for electronics and sensors	5	24 V DC load voltage supply for valves and outputs		
	1	0 V valves and outputs												
2	0 V electronics and sensors													
3	FE													
4	24 V DC power supply for electronics and sensors													
5	24 V DC load voltage supply for valves and outputs													
<table border="1"> <tr><td>7/8"</td><td>1</td><td>2</td><td>3</td><td>4</td><td>5</td></tr> <tr><td></td><td>0V</td><td>0V</td><td>FE</td><td>24V</td><td>24V</td></tr> </table>	7/8"	1	2	3	4	5		0V	0V	FE	24V	24V		
7/8"	1	2	3	4	5									
	0V	0V	FE	24V	24V									

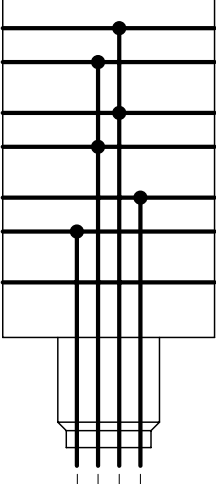
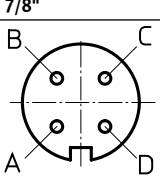

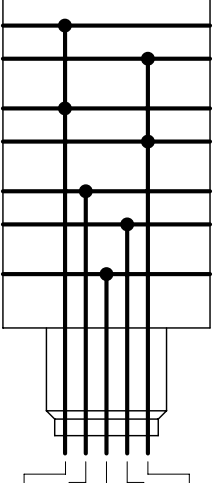
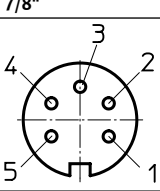
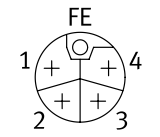
Data sheet – Interlinking block with system supply

Pin allocation – Metal interlinking blocks		Pin	Allocation																		
Circuitry																					
Round plug, 4-pin																					
 <p>0V Valves 24V Valves 0V Output 24V Output 0V El./Sen. 24V El./Sen. FE</p>	 <p>7/8"</p>	A	24 V DC supply voltage for electronics and sensors																		
		B	24 V DC load voltage supply for valves and outputs																		
		C	0 V DC supply voltage for electronics and sensors																		
		D	0 V DC load voltage supply for valves and outputs																		
		 Note The functional earth (FE) must be connected via the left-hand end plate.																			
<table border="1" data-bbox="151 884 391 940"> <tr> <td>7/8"</td> <td>A</td> <td>B</td> <td>D</td> <td>C</td> </tr> <tr> <td></td> <td>24V</td> <td>24V</td> <td>0V</td> <td>0V</td> </tr> </table>	7/8"	A	B	D	C		24V	24V	0V	0V											
7/8"	A	B	D	C																	
	24V	24V	0V	0V																	
Round plug, 5-pin																					
 <p>0V Valves 24V Valves 0V Output 24V Output 0V El./Sen. 24V El./Sen. FE</p>	 <p>7/8"</p>	1	0 V valves and outputs																		
		2	0 V electronics and sensors																		
		3	FE																		
		4	24 V DC power supply for electronics and sensors																		
		5	24 V DC load voltage supply for valves and outputs																		
		M12																			
		1	24 V DC power supply for electronics and sensors																		
		2	0 V valves and outputs																		
		3	0 V electronics and sensors																		
		4	24 V DC load voltage supply for valves and outputs																		
		FE	FE																		
<table border="1" data-bbox="127 1512 406 1590"> <tr> <td>7/8"</td> <td>1</td> <td>2</td> <td>3</td> <td>4</td> <td>5</td> </tr> <tr> <td>M12</td> <td>2</td> <td>3</td> <td>5</td> <td>1</td> <td>4</td> </tr> <tr> <td></td> <td>0V</td> <td>0V</td> <td>FE</td> <td>24V</td> <td>24V</td> </tr> </table>	7/8"	1	2	3	4	5	M12	2	3	5	1	4		0V	0V	FE	24V	24V			
7/8"	1	2	3	4	5																
M12	2	3	5	1	4																
	0V	0V	FE	24V	24V																

Data sheet – Interlinking block with system supply

Pin allocation – Metal interlinking blocks		Pin	Allocation																					
Circuitry																								
5-pin push-pull plug																								
	Plug pattern to PROFINET specification																							
	<table border="1"> <tr> <td>PP</td> <td>1</td> <td>2</td> <td>3</td> <td>4</td> <td>5</td> </tr> <tr> <td></td> <td>24V</td> <td>0V</td> <td>24V</td> <td>0V</td> <td>FE</td> </tr> </table>	PP	1	2	3	4	5		24V	0V	24V	0V	FE		<table border="1"> <tr> <td>1</td> <td>24 V DC power supply for electronics and sensors</td> </tr> <tr> <td>2</td> <td>0 V electronics and sensors</td> </tr> <tr> <td>3</td> <td>24 V DC load voltage supply for valves and outputs</td> </tr> <tr> <td>4</td> <td>0 V valves and outputs</td> </tr> <tr> <td>5</td> <td>FE</td> </tr> </table>	1	24 V DC power supply for electronics and sensors	2	0 V electronics and sensors	3	24 V DC load voltage supply for valves and outputs	4	0 V valves and outputs	5
PP	1	2	3	4	5																			
	24V	0V	24V	0V	FE																			
1	24 V DC power supply for electronics and sensors																							
2	0 V electronics and sensors																							
3	24 V DC load voltage supply for valves and outputs																							
4	0 V valves and outputs																							
5	FE																							

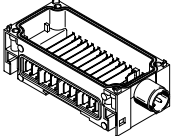
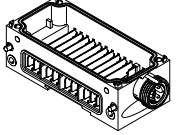
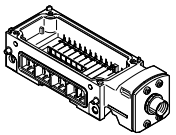
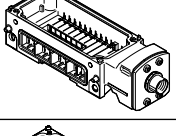
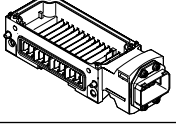
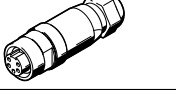
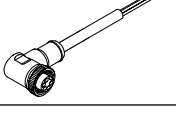
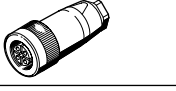
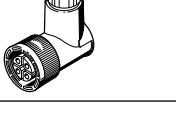
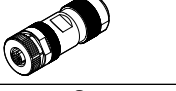
Data sheet – Interlinking block with system supply

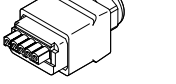
Ordering data				Part no.	Type
Designation					
Interlinking block with system supply					
	M18 connection, plastic interlinking block	4-pin	–	195746	CPX-GE-EV-S
			For ATEX environment	8022170	CPX-GE-EV-S-VL
	7/8" connection, plastic interlinking block	4-pin	–	541248	CPX-GE-EV-S-7/8-4POL
			5-pin	–	541244
	7/8" connection, metal interlinking block	4-pin	–	8022172	CPX-GE-EV-S-7/8-5POL-VL
			5-pin	–	568956
	7/8" connection, metal interlinking block	5-pin	–	550208	CPX-M-GE-EV-S-7/8-5POL
			For ATEX environment	8022165	CPX-M-GE-EV-S-7/8-5POL-VL
	M12x1 L-coded connection, metal interlinking block	5-pin	–	8098392	CPX-M-GE-EV-S-M12-5POL
	Push-pull plug connection (AIDA), metal interlinking block	5-pin	–	563057	CPX-M-GE-EV-S-PP-5POL
Connection sockets 7/8"					
	Power supply socket	5-pin		543107	NECU-G78G5-C2
		4-pin		543108	NECU-G78G4-C2
	Angled socket, 5-pin – open cable end, 5-wire	2 m		573855	NEBU-G78W5-K-2-N-LE5
M18 connection sockets					
	Straight socket, screw terminal	4-pin	PG9	18493	NTSD-GD-9
			PG13.5	18526	NTSD-GD-13.5
	Angled socket, screw terminal	4-pin	PG9	18527	NTSD-WD-9
			PG11	533119	NTSD-WD-11
Power supply sockets M12					
	Straight socket, screw terminal	5-pin		8166793	NECL-L12G5-C2-Q10
	Angled socket, screw terminal	5-pin		8166794	NECL-L12W5-C2-Q10
Push-pull power supply socket					
	Socket, spring-loaded terminal, plug pattern PP, fulfils requirements to AIDA	5-pin		5195383	NECU-M-PPG5PP-C1-PN

Data sheet – Interlinking block with system supply

Ordering data		Part no.	Type
Designation			
Mounting accessories			
	Screws for mounting the bus node/connection block on the plastic interlinking block	Bus node/metal connection block	550218 CPX-DPT-30X32-S-4X
	Screws for mounting the bus node/connection block on the metal interlinking block	Bus node/plastic connection block	550219 CPX-M-M3x22-4x
		Bus node/metal connection block	550216 CPX-M-M3x22-S-4x

Data sheet – Interlinking block without power supply

Function

Interlinking blocks ensure the electrical supply of all other CPX modules. They have contact rails, from which the other CPX components on the interlinking modules are supplied with power. Internal division of the power supply makes it possible to switch off specific areas of the sensors and actuators individually.

Area of application

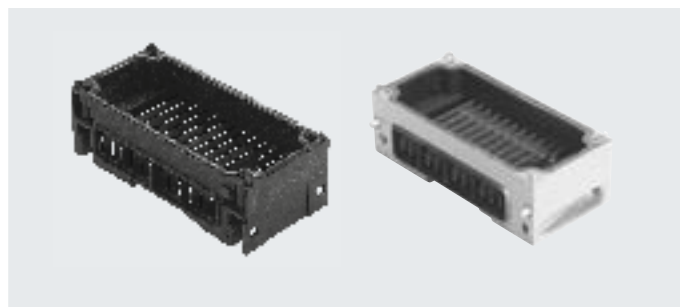

- All voltages are fed through to the next module by means of the interlinking blocks without supply.
- The connected electronics module for inputs/outputs or bus node taps off the required voltage.



General technical data		CPX-GE-EV	CPX-M-GE-EV
Type			
Electrical connection		–	–
Nominal operating voltage	[V DC]	24	24
Acceptable current load (per contact/contact rail)	[A]	16	16
Degree of protection to EN 60529		Depending on connection block	
Ambient temperature	[°C]	–5 ... +50	
Note on materials		RoHS-compliant	
Materials		PA-reinforced	Aluminium
PWIS conformity		VDMA24364-B2-L	
Grid dimension	[mm]	50	
Dimensions W x L x H	[mm]	50 x 107 x 35	
Product weight	[g]	108	169

Pin allocation		Pin	Allocation
Circuitry		–	–
	0V Valves	–	–
	24V Valves	–	–
	0V Output	–	–
	24V Output	–	–
	0V EL./Sen.		
	24V EL./Sen.		
	FE		

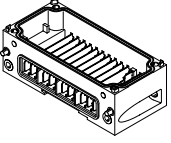
Data sheet – Interlinking block without power supply

Ordering data				
Designation		Part no.	Type	
Interlinking block without power supply				
	Plastic interlinking block	195742	CPX-GE-EV	
	Metal interlinking block	550206	CPX-M-GE-EV	
Mounting accessories				
	Screws for mounting the bus node/connection block on the plastic interlinking block	Bus node/metal connection block	550218	CPX-DPT-30X32-S-4X
		Bus node/plastic connection block	550219	CPX-M-M3x22-4x
	Screws for mounting the bus node/connection block on the metal interlinking block	Bus node/metal connection block	550216	CPX-M-M3x22-S-4x

Data sheet – Interlinking block with additional supply for outputs

Function

Interlinking blocks ensure the electrical supply of all other CPX modules. They have contact rails, from which the other CPX components on the interlinking modules are supplied with power. Internal division of the power supply makes it possible to switch off specific areas of the sensors and actuators individually.

Area of application

- 24 V DC supply voltage for outputs

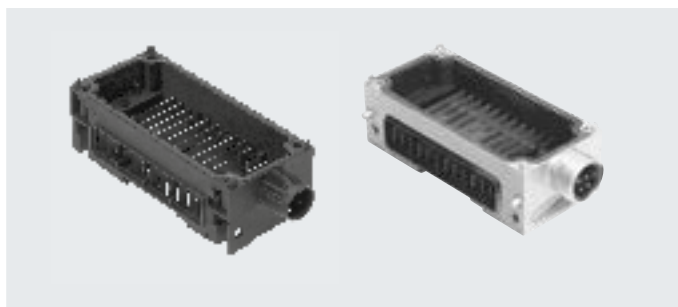

General technical data		
Nominal operating voltage	[V DC]	24
Degree of protection to EN 60529		Depending on connection block
Ambient temperature	[°C]	-5 ... +50
Note on materials		RoHS-compliant
PWIS conformity		VDMA24364-B2-L
Grid dimension	[mm]	50
Dimensions W x L x H	[mm]	50 x 107 x 35

Technical data – Plastic interlinking blocks					
Type		CPX-GE-EV-Z			
		-VL	-7/8-4POL	-7/8-5POL	-7/8-5POL-VL
Electrical connection		M18	M18	7/8", 4-pin	7/8", 5-pin
Power supply	Outputs	[A]	Max. 16	Max. 8	Max. 10
Materials		PA-reinforced			
Product weight		[g]	125		

Technical data – Metal interlinking blocks			
Type		CPX-M-GE-EV-Z	
		-7/8-5POL	-7/8-5POL-VL
Electrical connection		7/8", 5-pin	7/8", 5-pin
Power supply	Outputs	[A]	Max. 8
Materials		Die-cast aluminium	
Product weight		[g]	187
			187
			279

Data sheet – Interlinking block with additional supply for outputs

Pin allocation – Plastic interlinking blocks



Circuitry		Pin	Allocation																
Round plug, 4-pin																			
	0V Valves		1	n.c.															
	24V Valves		2	24 V DC load voltage supply for outputs															
0V Output	0V Output	3	0 V																
24V Output	24V Output	4	FE																
0V EL./Sen.	0V EL./Sen.	7/8"																	
24V EL./Sen.	24V EL./Sen.		A	n.c.															
FE	FE		B	24 V DC load voltage supply for outputs															
		C	FE																
		D	0V																
<table border="1"> <tr> <td>M18</td> <td>1</td> <td>2</td> <td>3</td> <td>4</td> </tr> <tr> <td>7/8"</td> <td>A</td> <td>B</td> <td>D</td> <td>C</td> </tr> <tr> <td></td> <td>n.c.</td> <td>24V</td> <td>0V</td> <td>FE</td> </tr> </table>	M18	1	2	3	4	7/8"	A	B	D	C		n.c.	24V	0V	FE				
M18	1	2	3	4															
7/8"	A	B	D	C															
	n.c.	24V	0V	FE															

Round plug, 5-pin																
	0V Valves		1	0 V outputs												
	24V Valves		2	n.c.												
0V Output	0V Output	3	FE													
24V Output	24V Output	4	n.c.													
0V EL./Sen.	0V EL./Sen.	5	24 V DC load voltage supply for outputs													
24V EL./Sen.	24V EL./Sen.															
FE	FE															
<table border="1"> <tr> <td>7/8"</td> <td>1</td> <td>2</td> <td>3</td> <td>4</td> <td>5</td> </tr> <tr> <td></td> <td>0V</td> <td>n.c.</td> <td>FE</td> <td>n.c.</td> <td>24V</td> </tr> </table>	7/8"	1	2	3	4	5		0V	n.c.	FE	n.c.	24V				
7/8"	1	2	3	4	5											
	0V	n.c.	FE	n.c.	24V											

Data sheet – Interlinking block with additional supply for outputs

Pin allocation – Metal interlinking blocks		Pin	Allocation												
Circuitry															
Round plug, 5-pin															
	<p>0V Valves</p> <p>24V Valves</p> <p>0V Output</p> <p>24V Output</p> <p>0V EL./Sen.</p> <p>24V EL./Sen.</p> <p>FE</p>		<table border="1"> <tr><td>1</td><td>0 V outputs</td></tr> <tr><td>2</td><td>n.c.</td></tr> <tr><td>3</td><td>FE</td></tr> <tr><td>4</td><td>n.c.</td></tr> <tr><td>5</td><td>24 V DC load voltage supply for outputs</td></tr> </table>	1	0 V outputs	2	n.c.	3	FE	4	n.c.	5	24 V DC load voltage supply for outputs		
	1	0 V outputs													
2	n.c.														
3	FE														
4	n.c.														
5	24 V DC load voltage supply for outputs														
<table border="1"> <tr><td>7/8"</td><td>1</td><td>2</td><td>3</td><td>4</td><td>5</td></tr> <tr><td></td><td>0V</td><td>n.c.</td><td>FE</td><td>n.c.</td><td>24V</td></tr> </table>	7/8"	1	2	3	4	5		0V	n.c.	FE	n.c.	24V			
7/8"	1	2	3	4	5										
	0V	n.c.	FE	n.c.	24V										
5-pin push-pull plug															
	<p>0V Valves</p> <p>24V Valves</p> <p>0V Output</p> <p>24V Output</p> <p>0V EL./Sen.</p> <p>24V EL./Sen.</p> <p>FE</p>		<table border="1"> <tr><td>1</td><td>n.c.</td></tr> <tr><td>2</td><td>n.c.</td></tr> <tr><td>3</td><td>24 V DC load voltage supply for outputs</td></tr> <tr><td>4</td><td>0 V outputs</td></tr> <tr><td>5</td><td>FE</td></tr> </table>	1	n.c.	2	n.c.	3	24 V DC load voltage supply for outputs	4	0 V outputs	5	FE		
	1	n.c.													
2	n.c.														
3	24 V DC load voltage supply for outputs														
4	0 V outputs														
5	FE														
<table border="1"> <tr><td>PP</td><td>1</td><td>2</td><td>3</td><td>4</td><td>5</td></tr> <tr><td></td><td>n.c.</td><td>n.c.</td><td>24V</td><td>0V</td><td>FE</td></tr> </table>	PP	1	2	3	4	5		n.c.	n.c.	24V	0V	FE			
PP	1	2	3	4	5										
	n.c.	n.c.	24V	0V	FE										

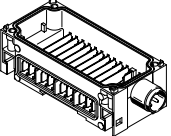
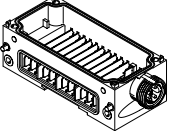
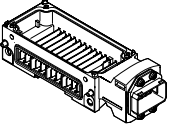
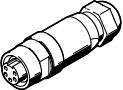
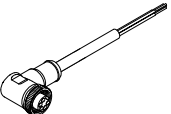
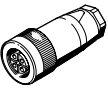
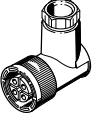
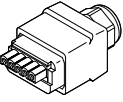
Data sheet – Interlinking block with additional supply for outputs

Ordering data				Part no.	Type
Designation					
Interlinking block with additional supply for outputs					
	M18 connection, plastic interlinking block	4-pin	–	195744	CPX-GE-EV-Z
	M18 connection, plastic interlinking block	4-pin	For ATEX environment	8022166	CPX-GE-EV-Z-VL
	7/8" connection, plastic interlinking block	4-pin	–	541250	CPX-GE-EV-Z-7/8-4POL
		5-pin	–	541246	CPX-GE-EV-Z-7/8-5POL
		5-pin	For ATEX environment	8022173	CPX-GE-EV-Z-7/8-5POL-VL
	7/8" connection, metal interlinking block	5-pin	–	550210	CPX-M-GE-EV-Z-7/8-5POL
5-pin		For ATEX environment	8022158	CPX-M-GE-EV-Z-7/8-5POL-VL	
	Push-pull plug connection (AIDA), metal interlinking block	5-pin	–	563058	CPX-M-GE-EV-Z-PP-5POL
Connection sockets 7/8"					
	Power supply socket	5-pin		543107	NECU-G78G5-C2
		4-pin		543108	NECU-G78G4-C2
	Angled socket, 5-pin – open cable end, 5-wire	2 m		573855	NEBU-G78W5-K-2-N-LE5
M18 connection sockets					
	Straight socket, screw terminal	4-pin	PG9	18493	NTSD-GD-9
			PG13.5	18526	NTSD-GD-13.5
	Angled socket, screw terminal	4-pin	PG9	18527	NTSD-WD-9
	Angled socket, screw terminal	4-pin	PG11	533119	NTSD-WD-11
Push-pull power supply socket					
	Socket, spring-loaded terminal, plug pattern PP, fulfils requirements to AIDA	5-pin		5195383	NECU-M-PPG5PP-C1-PN
Mounting accessories					
	Screws for mounting the bus node/connection block on the plastic interlinking block	Bus node/metal connection block		550218	CPX-DPT-30X32-S-4X
		Bus node/plastic connection block		550219	CPX-M-M3x22-4x
		Bus node/metal connection block		550216	CPX-M-M3x22-S-4x

Data sheet – Interlinking block with additional supply for valves

Function

Interlinking blocks ensure the electrical supply of all other CPX modules. They have contact rails, from which the other CPX components on the interlinking modules are supplied with power. Internal division of the power supply makes it possible to switch off specific areas of the sensors and actuators individually.

Area of application



- 24 V DC supply voltage for valves



General technical data		CPX-GE-EV-V	CPX-GE-EV-VL	CPX-GE-EV-V-7/8-4POL
Type		M18		7/8", 4-pin
Electrical connection		M18		
Nominal operating voltage	[V DC]	24		
Acceptable current load (per contact/contact rail)	[A]	16	8	10
Degree of protection to EN 60529		Depending on connection block		
Ambient temperature	[°C]	-5 ... +50		
Note on materials		RoHS-compliant		
Materials		PA-reinforced		
PWIS conformity		VDMA24364-B2-L		
Grid dimension	[mm]	50		
Dimensions W x L x H	[mm]	50 x 107 x 35		
Product weight	[g]	125		

Pin allocation – Plastic interlinking blocks		Pin	Allocation															
Round plug, 4-pin																		
	M18 	1	n.c.															
		2	24 V DC load voltage supply for valves															
	3	0 V																
	4	FE																
	7/8" 	A	n.c.															
		B	24 V DC load voltage supply for valves															
		C	FE															
		D	0 V															
<table border="1"> <tr> <td>M18</td> <td>1</td> <td>2</td> <td>3</td> <td>4</td> </tr> <tr> <td>7/8"</td> <td>A</td> <td>B</td> <td>D</td> <td>C</td> </tr> <tr> <td></td> <td>n.c.</td> <td>24V</td> <td>0V</td> <td>FE</td> </tr> </table>	M18	1	2	3	4	7/8"	A	B	D	C		n.c.	24V	0V	FE			
M18	1	2	3	4														
7/8"	A	B	D	C														
	n.c.	24V	0V	FE														

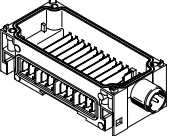
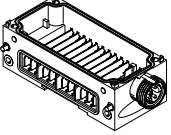
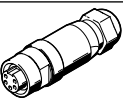
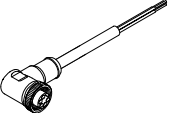
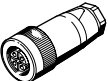
Data sheet – Interlinking block with additional supply for valves

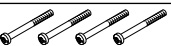
Ordering data				Part no.	Type
Designation					
Interlinking block with additional supply for valves					
	M18 connection, plastic interlinking block	4-pin	–	533577	CPX-GE-EV-V
			For ATEX environment	8022171	CPX-GE-EV-V-VL
	7/8" connection, plastic interlinking block	4-pin	–	541252	CPX-GE-EV-V-7/8-4POL
Connection sockets 7/8"					
	Power supply socket	4-pin		543108	NECU-G78G4-C2
	Angled socket, 5-pin – open cable end, 5-wire	2 m		573855	NEBU-G78W5-K-2-N-LE5
M18 connection sockets					
	Straight socket, screw terminal	4-pin	PG9	18493	NTSD-GD-9
		4-pin	PG13.5	18526	NTSD-GD-13.5
	Angled socket, screw terminal	4-pin	PG9	18527	NTSD-WD-9
	Angled socket, screw terminal	4-pin	PG11	533119	NTSD-WD-11
Mounting accessories					
	Screws for mounting the bus node/connection block on the plastic interlinking block	Bus node/metal connection block		550218	CPX-DPT-30X32-S-4X

Data sheet – Interlinking block with system forwarding

Function

Interlinking blocks ensure the electrical supply of all other CPX modules. They have contact rails, from which the other CPX components on the interlinking modules are supplied with power. Internal division of the power supply makes it possible to switch off specific areas of the sensors and actuators individually.

Area of application

- Forwarding of 24 V DC supply voltage for the electronics of the CPX terminal
- Forwarding of 24 V DC supply voltage for inputs
- Forwarding of 24 V DC supply voltage for valves
- Forwarding of 24 V DC supply voltage for outputs



General technical data		
Nominal operating voltage	[V DC]	24
Degree of protection to EN 60529		Depending on connection block
Ambient temperature	[°C]	-5 ... +50
Note on materials		RoHS-compliant
PWIS conformity		VDMA24364-B2-L
Grid dimension	[mm]	50
Dimensions W x L x H	[mm]	50 x 107 x 35

Technical data – Metal interlinking blocks			
Type	CPX-M-GE-EV-W-M12-5POL		
Electrical connection	Socket		
	M12x1		
	5-pin		
	L-coded		
Power supply	Sensors and electronics	[A]	Max. 16
	Valves and outputs	[A]	Max. 16
Corrosion resistance class CRC ¹⁾	0		
Type of mounting	Angled fitting		
Materials	Die-cast aluminium		
Certification	c UL - Recognized (OL)		
Product weight	[g]	266	

1) Additional information: www.festo.com/x/topic/kbk



Note

Points to note about the interlinking block CPX-M-GE-EV-W-M12-5POL:

- Must be mounted as the first module to the right or to the left of the system supply
- Only one interlinking block permitted per CPX terminal

Data sheet – Interlinking block with system forwarding

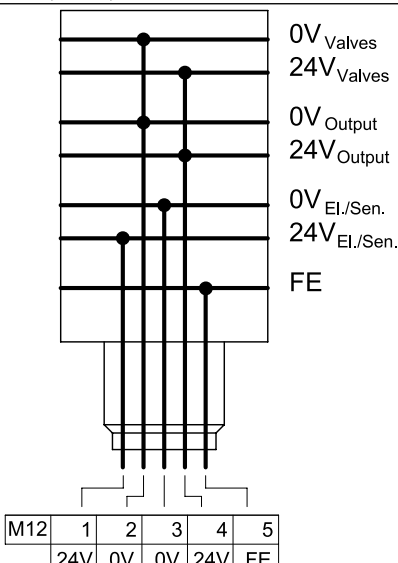
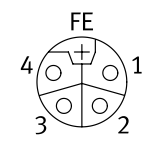
Pin allocation – Metal interlinking blocks		Pin	Allocation												
Circuitry															
Round plug, 5-pin															
 <table border="1" data-bbox="95 862 375 929"> <tr> <td>M12</td> <td>1</td> <td>2</td> <td>3</td> <td>4</td> <td>5</td> </tr> <tr> <td></td> <td>24V</td> <td>0V</td> <td>0V</td> <td>24V</td> <td>FE</td> </tr> </table>	M12	1	2	3	4	5		24V	0V	0V	24V	FE	M12 	1	24 V DC power supply for electronics and sensors
	M12	1	2	3	4	5									
	24V	0V	0V	24V	FE										
		2	0 V valves and outputs												
		3	0 V electronics and sensors												
		4	24 V DC load voltage supply for valves and outputs												
		FE	FE												

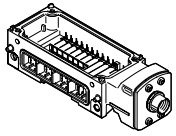
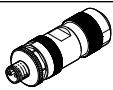
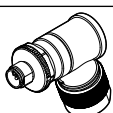
Ordering data				
Designation		Part no.	Type	
Interlinking block with system forwarding				
	M12x1 L-coded connection, metal interlinking block	5-pin	8098391	CPX-M-GE-EV-W-M12-5POL
Power supply plugs M12				
	Straight plug, screw terminal	5-pin	8166791	NECL-S-L12G5-C2-Q10
	Angled plug, screw terminal	5-pin	8166792	NECL-S-L12W5-C2-Q10

Data sheet – Pneumatic interface for valve terminal MPA-S

Function

The pneumatic interface VMFA-FB establishes the electromechanical connection between the CPX terminal and the valve terminal MPA-S.

The signals from the bus node are forwarded to the control electronics in the electrical modules of the valve terminal MPA-S via the integrated CPX bus. The bus signal for activating the solenoid coils is converted in the electronics module for max. 8 coils.

From a technical point of view, the individual MPA pneumatic modules each represent a separate electrical module with digital outputs. Valves, which are galvanically isolated, can be supplied with power via the interlinking block CPX-GE-EV-V.

Area of application

- Interface to the valve terminal MPA-S
- Max. 128 solenoid coils
- Characteristics of the electronics module of the valve terminal MPA-S can be parameterised; for example, status of the solenoid coils in the event of fieldbus communication being interrupted (fail-safe), individual channel diagnostics can be activated, condition monitoring can be activated individually for each valve
- The pneumatic interface receives the voltage for the electronics and the supply voltage for the valves from the left-hand interlinking block and feeds them through to the electronics modules of the valve terminal MPA-S
- Electronics modules of the valve terminal MPA-S:
 - Undervoltage of valves
 - Short circuit of valves
 - Open load of valves
 - Counter preset reached in condition monitoring



General technical data		VMFA-FB-EPL-G	VMFA-FB-EPL-E
Type			
Valve terminal design		Modular, valve sizes can be mixed	
Maximum number of valve positions		64	
Maximum number of pressure zones		17	
Signal status indication		LED	
Pilot air supply		Internal	External
Operating pressure	[MPa]	0.3 ... 0.8	-0.09 ... 1
	[bar]	3 ... 8	-0.9 ... 10
Pilot pressure	[MPa]	0.3 ... 0.8	0.3 ... 0.8
	[bar]	3 ... 8	3 ... 8
Product weight	[g]	320	
Degree of protection		IP67	

Technical data – Electrics		
Nominal operating voltage	[V DC]	24
Permissible voltage fluctuations	[%]	±25

Materials	
Note on materials	RoHS-compliant
LABS (PWIS) conformity	VDMA24364-B1/B2-L

Accessories – Pneumatic interface for valve terminal MPA-S

Operating and environmental conditions	
Operating medium	Compressed air to ISO 8573-1:2010 [7:4:4]
Note on the operating/pilot medium	Lubricated operation possible (in which case lubricated operation will always be required)
Ambient temperature	[°C] -5 ... +50
Temperature of medium	[°C] -5 ... +50
Storage temperature	[°C] -20 ... +40
Relative humidity	Max. 90% at 40°C
Corrosion resistance class CRC ¹⁾	1
CE marking (see declaration of conformity)	To EU EMC Directive ²⁾
	To EU RoHS Directive
	To EU Explosion Protection Directive (ATEX)
UKCA marking (see declaration of conformity)	To UK EMC regulations
	To UK RoHS regulations
	To UK regulations for explosions
KC marking	KC EMC
Certification	RCM compliance mark
	c UL us - Recognized (OL)
Certificate-issuing authority	DNV 15.0193 X

1) More information www.festo.com/x/topic/crc

2) For information about the area of use, see the EC declaration of conformity at: www.festo.com/catalogue/... → Support/Downloads.

If the devices are subject to usage restrictions in residential, commercial or light-industrial environments, further measures for the reduction of the emitted interference may be necessary.

ATEX	
ATEX category for gas	II 3G
Type of (ignition) protection for gas	Ex ec IIC T4 Gc X
Explosion ambient temperature	[°C] -5 ≤ Ta ≤ +50
Explosion protection certification outside the EU	EPL Db (GB)
	EPL Gb (GB)

Overview – Pneumatic interface VMPA-FB

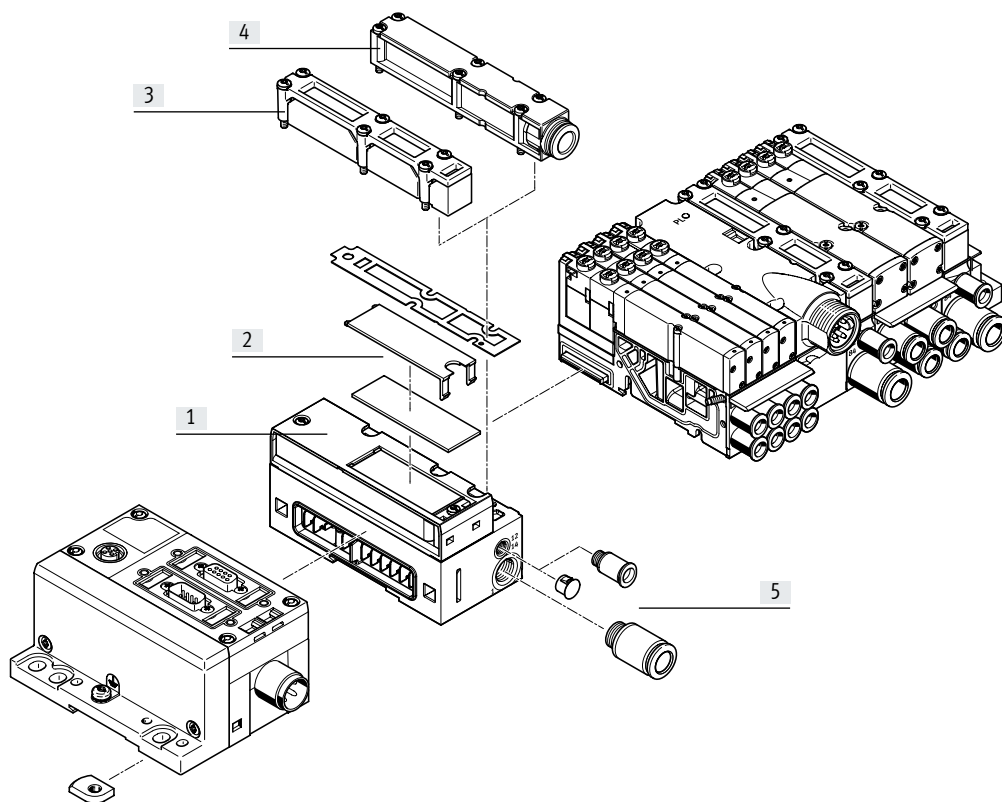

- [1] Pneumatic interface VMPA-FB
- [2] Inscription label
- [3] Flat plate silencer
- [4] Exhaust plate for ducted exhaust air
- [5] Fittings

Accessories – Pneumatic interface for valve terminal MPA-S

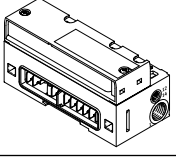
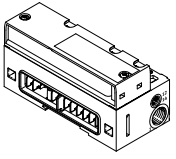
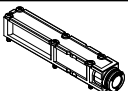
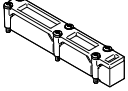
Ordering data		Part no.	Type
Designation			
Pneumatic interface for CPX plastic interlinking module			
	Ducted exhaust air, internal pilot air	533370	VMPA-FB-EPL-G
	Ducted exhaust air, external pilot air	533369	VMPA-FB-EPL-E
	Flat plate silencer, internal pilot air	533372	VMPA-FB-EPL-GU
	Flat plate silencer, external pilot air	533371	VMPA-FB-EPL-EU
Pneumatic interface for CPX metal interlinking module			
	Ducted exhaust air, internal pilot air	552286	VMPA-FB-EPLM-G
	Ducted exhaust air, external pilot air	552285	VMPA-FB-EPLM-E
	Flat plate silencer, internal pilot air	552288	VMPA-FB-EPLM-GU
	Flat plate silencer, external pilot air	552287	VMPA-FB-EPLM-EU
Exhaust plate			
	For ducted exhaust air, with 10 mm push-in connector	533375	VMPA-AP
	For ducted exhaust air, with QS-3/8 connector	541629	VMPA-AP-3/8
	Flat plate silencer	533374	VMPA-APU

Data sheet – Pneumatic interface for valve terminal MPA-L

Function

The pneumatic interface VMPAL establishes the electromechanical connection between the terminal CPX and the valve terminal MPA-L.

The bus signal for actuating the solenoid coils is converted in the pneumatic interface for the entire valve terminal.

The interlinking within the valve terminal is identical with the interlinking with multi-pin plug connections.

Area of application

- Actuation of the valve terminal MPA-L
- Max. 32 solenoid coils
- The pneumatic interface receives the voltage for the electronics and the supply voltage for the valves from the left-hand interlinking block and feeds them through to the electrical modules of the valve terminal MPA-L



General technical data		
Type		VMPAL-EPL-CPX
Number of solenoid coils		32
Operating pressure	[bar]	-0.9 ... 10
Pilot pressure	[bar]	3 ... 8
Nominal operating voltage	[V DC]	24
Degree of protection to EN 60529		IP67
Ambient temperature	[°C]	-5 ... +50
Note on materials		RoHS-compliant
PWIS conformity		VDMA24364-B1/B2-L

Data sheet – Pneumatic interface for valve terminal MPA-L

Overview – Pneumatic interface VMPAL

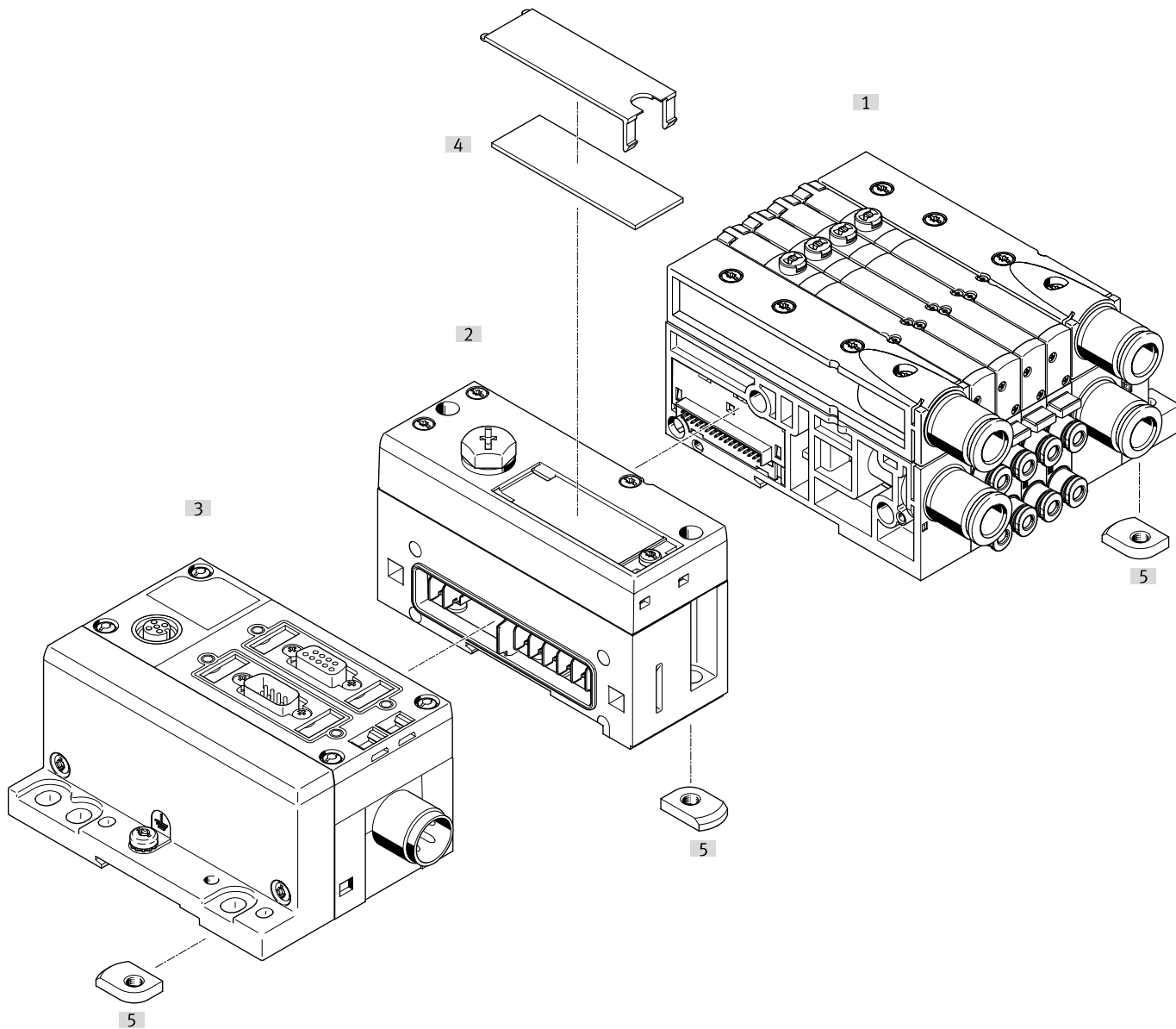

[1] Valve terminal MPA-L
[2] Pneumatic interface VMPAL

[3] Terminal CPX

[4] Inscription label

[5] Mounting for H-rail

Ordering data

Designation

Part no.

Type

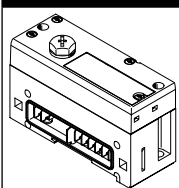

Pneumatic interface for CPX plastic interlinking module

570783

VMPAL-EPL-CPX

Data sheet – Pneumatic interface for valve terminal VTSA/VTSA-F

Function

The pneumatic interface VTSA provides the electromechanical connection between the terminal CPX and valve terminal VTSA/VTSA-F.

A complete pneumatic control loop system (FB-valve-drive-sensor-FB) can therefore be connected to the fieldbus using the input modules of the CPX terminal.

Different circuits for valves and electrical outputs are implemented using an additional supply. The integrated valve diagnostics enable the causes of errors to be found quickly, increasing system availability.

Area of application

- Interface to the valve terminal VTSA and VTSA-F
- Max. 32 solenoid coils
- Address space allocation (configuration) of valve terminals can be set using integrated DIL switches
- Properties of the pneumatic interface can be parameterised, e.g. status of the solenoid coil in the event of fieldbus communication being interrupted (fail-safe)
- The pneumatic interface receives the voltage for the electronics and the supply voltage for the valves from the left-hand interlinking block
- Detection of missing solenoid coils and short circuit monitoring for the valves



General technical data			
Max. no. of valve positions			16 with double solenoid valves 32 with single solenoid valves
Valve terminal interface			Type 44, VTSA
Electrical control			Fieldbus
Electrical connection			Via CPX
Diagnostics			Undervoltage of valves
Parameterisation			Failsafe per channel
			Forcing per channel
			Idle mode per channel
			Module monitoring
LED displays			1 group diagnostics
			Channel status on valves
Fuse protection (short circuit)			Internal electronic fuse per valve output
Galvanic isolation channel – internal bus			Yes, when using an additional supply for the valves
Nominal operating voltage		[V DC]	24
Operating voltage range		[V DC]	21.6 ... 26.4
Intrinsic current consumption at nominal operating voltage	Electronics	[mA]	Typically 15
	Valves	[mA]	Typically 50
Max. power supply per channel		[A]	0.2
Max. residual current per module		[A]	4
Degree of protection			IP65
			NEMA 4
Product weight		[g]	590

Data sheet – Pneumatic interface for valve terminal VTSA/VTSA-F

Materials	
Housing	Die-cast aluminium
Cover	PA
Note on materials	RoHS-compliant
PWIS conformity	VDMA24364-B1/B2-L

Operating and environmental conditions		
Ambient temperature	[°C]	-5 ... +50
Corrosion resistance class CRC ¹⁾		0

1) Additional information: www.festo.com/x/topic/kbk

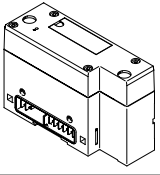
Ordering data				
Designation		Part no.	Type	
	For plastic interlinking block	543416	VABA-S6-1-X1	
	For metal interlinking block	Diagnostics via fieldbus	550663	VABA-S6-1-X2
		Diagnostics via process data image	573613	VABA-S6-1-X2-D

Data sheet – Pneumatic interface for valve terminal VTSA-F-CB

Function

The pneumatic interface provides the electromechanical connection between the terminal CPX and valve terminal VTSA-F-CB.

A complete pneumatic control loop system (FB-valve-drive-sensor-FB) can therefore be connected to the fieldbus using the input modules of the CPX terminal.

Different circuits for valves and electrical outputs are implemented using an additional supply. The integrated valve diagnostics enable the causes of errors to be found quickly, increasing system availability.

Area of application

- Interface to valve terminal VTSA-F-CB
- Max. 24 solenoid coils
- Properties of the pneumatic interface can be parameterised, e.g. status of the solenoid coil in the event of fieldbus communication being interrupted (fail-safe)
- The pneumatic interface receives the voltage for the electronics and the supply voltage for the valves from the left-hand interlinking block
- The supply voltage for the valves is provided from the left-hand interlinking block or externally
- Detection of missing solenoid coils and short circuit monitoring for the valves



General technical data		Pneumatic interface		
		Without voltage zones	With safe voltage zones	With external power supply to the valves
Max. no. of valve positions		12 with double solenoid valves		
		24 with single solenoid valves		
Valve terminal interface		Type 44, VTSA		
Electrical control		Fieldbus		
Electrical connection		Via CPX		
Electrical connection output	Function	–	Safe digital output	–
	Connection type	–	Socket	–
	Connection technology	–	M12x1, A-coded to EN 61076-2-101	–
	Number of pins/wires	–	5	–
Electrical connection, power supply to valves	Function	–	–	–
	Connection type	–	–	Plug
	Connection technology	–	–	3x M12x1, A-coded
	Number of pins/wires	–	–	5
Diagnostics		Wire break per valve coil		
		Short circuit of valves		
		Undervoltage of valves		
Parameterisation		Failsafe per channel		
		Forcing per channel		
		Idle mode per channel		
		Module monitoring		
LED displays		1 group diagnostics	1 group diagnostics	1 group diagnostics
		Channel status on valves	–	Channel status on valves
		–	–	3 load supply

Data sheet – Pneumatic interface for valve terminal VTSA-F-CB

Technical data – Electrics		Pneumatic interface			
		Without voltage zones	With safe voltage zones	With external power supply to the valves	
Nominal operating voltage	[V DC]	24			
Operating voltage range	[V DC]	21.6 ... 26.4			
Intrinsic current consumption at nominal operating voltage	Electronics	[mA]	Typically 11	<ul style="list-style-type: none"> Typically 45 for electronics without CPX-FVDA-P2 Typically 110 for electronics with CPX-FVDA-P2 	Typically 11
	Valves	[mA]	Typically 45	<ul style="list-style-type: none"> Typically 25 for valves without CPX-FVDA-P2 Typically 90 for valves with CPX-FVDA-P2 	Typically 45
Max. power supply per channel	[A]	0.2	0.2	0.2	
Max. residual current per module	[A]	6	4.5	6	
Fuse protection (short circuit)		Internal electronic fuse per valve output	Internal electronic fuse per valve output	Internal electronic fuse per valve output	
Galvanic isolation channel – internal bus		Yes, when using an additional supply for the valves	Yes, when using an additional supply for the valves	Yes	

Materials		Pneumatic interface		
		Without voltage zones	With safe voltage zones	With external power supply to the valves
Housing		Die-cast aluminium	–	Die-cast aluminium
Cover		PA	PA	PA
Sub-base		–	Die-cast aluminium	–
Seals		–	NBR	–
Screws		–	Steel	–
Note on materials		RoHS-compliant	RoHS-compliant	RoHS-compliant
PWIS conformity		VDMA24364-B1/B2-L	VDMA24364-B1/B2-L	VDMA24364-B1/B2-L

Operating and environmental conditions		Pneumatic interface		
		Without voltage zones	With safe voltage zones	With external power supply to the valves
Ambient temperature	[°C]	–5 ... +50	–5 ... +50	–5 ... +50
Storage temperature	[°C]	–	–20 ... +60	–
Corrosion resistance class CRC ¹⁾		0	0	0
Shock resistance		–	Shock test with severity level 2 to FN 942017-5 and EN 60068-2-27	–
Vibration resistance		–	Transport application test with severity level 2 to FN 942017-4 and EN 60068-2-6	–
CE marking (see declaration of conformity) ³⁾		–	To EU EMC Directive ²⁾	–
		–	To EU RoHS Directive	–
UKCA marking (see declaration of conformity) ³⁾		–	To UK instructions for EMC	–
		–	To UK RoHS instructions	–
Degree of protection		IP65	IP65	IP65
		NEMA 4	–	NEMA 4

1) Additional information: www.festo.com/x/topic/kbk

2) For information about the area of use, see the EC declaration of conformity at: www.festo.com/catalogue/... → Support/Downloads.

If the devices are subject to usage restrictions in residential, commercial or light-industrial environments, further measures for the reduction of the emitted interference may be necessary.

3) Additional information: www.festo.com/catalogue/... → Support/Downloads.

Data sheet – Pneumatic interface for valve terminal VTSA-F-CB

Combinations of bus nodes/control blocks with pneumatic interface					
Bus node/control block	Part no.	Pneumatic interface			
		VABA-...-X1-CB	VABA-...-X2-CB	VABA-...-X2-F1-CB	VABA-...-X2-F2-CB
CPX-FB13	195740	■	■	■	■
CPX-FB36	1912451	■	■	–	–
CPX-FB37	2735960	■	■	–	–
CPX-FB43	8110369	■	■	■	■
CPX-M-FB44	8110370	■	■	■	■

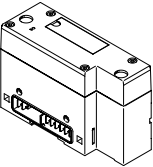
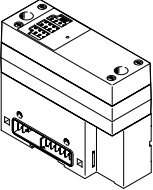
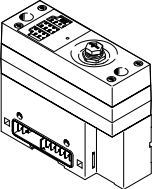
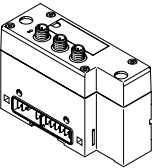
Ordering data					
	Description		Product weight [g]	Part no.	Type
Pneumatic interface without voltage zones					
	For plastic interlinking block		560	8082877	VABA-S6-1-X1-CB
	For metal interlinking block		560	8082876	VABA-S6-1-X2-CB
Pneumatic interface with voltage zones					
	For metal interlinking block	Division of the connected valves into up to 3 safe voltage zones	734	8068240	VABA-S6-1-X2-F1-CB
	For metal interlinking block	<ul style="list-style-type: none"> • Division of the connected valves into up to 2 safe voltage zones • 1 external safe voltage zone 	754	8068241	VABA-S6-1-X2-F2-CB
	For plastic interlinking block	<ul style="list-style-type: none"> • Division of the connected valves into up to 3 voltage zones • External power supply for each voltage zone 	580	8082879	VABA-S6-1-X1-3V-CB
	For metal interlinking block	<ul style="list-style-type: none"> • Division of the connected valves into up to 3 voltage zones • External power supply for each voltage zone 	580	8082878	VABA-S6-1-X2-3V-CB

Data sheet

Dimensions – Plastic interlinking module

Download CAD data → www.festo.com

With bus nodes and connection blocks

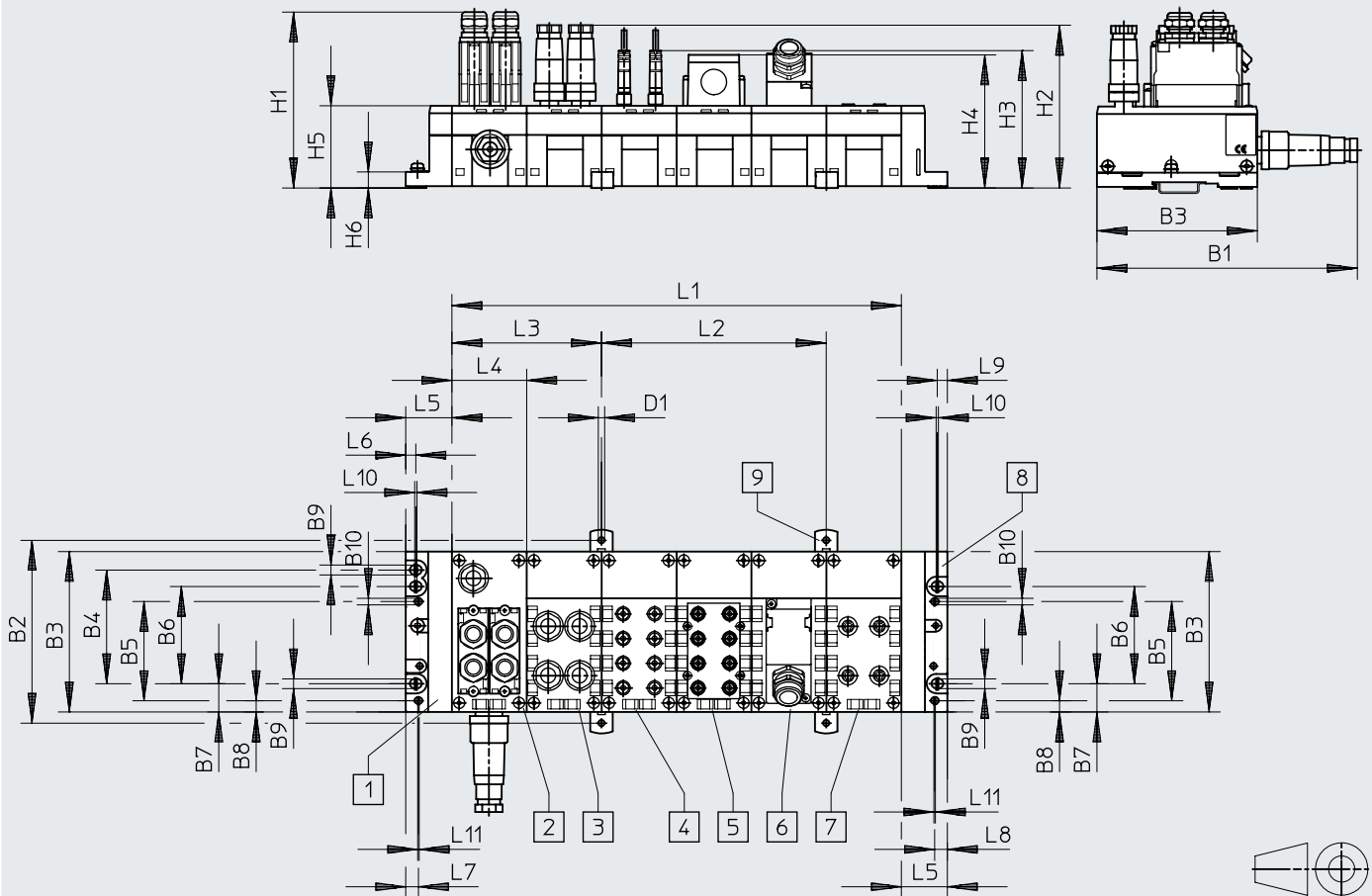

- [1] Left-hand end plate (earthing plate optional)
 - [2] Bus node
 - [3] Connection block CPX-AB-4-M12-8POL
 - [4] Connection block CPX-AB-8-M8-3POL
 - [5] Connection block CPX-AB-8-KL-4POL
 - [6] Connection block CPX-AB-1-SUB-BU-25POL
 - [7] Connection block CPX-AB-4-M12-8POL
 - [8] Right-hand end plate
 - [9] Mounting clip for wall mounting (required every 2 ... 3 connection blocks)
- n Number of CPX modules

Type	B1	B2	B3	B4	B5	B6	B7	B8	B9	B10	D1
CPX-M	175	122.3	107.3	78	66.3	65	18.9	7.5	6.6	4.4	∅ 4.3

Type	H1	H2	H3	H4	H5	H6
CPX-M	118	110	92	89.1	55.1	10.8

Type	L1 ¹⁾	L2	L3 ²⁾	L4	L5 ³⁾	L6	L7	L8	L9	L10	L11
CPX-M	nx50.1	150.3	100.2	50.1	30.8	7.1	8.8	8.5	6.8	1.5	1

1) n = Number of CPX modules

Data sheet

Dimensions – Metal interlinking block

Download CAD data → www.festo.com

With bus nodes and connection blocks

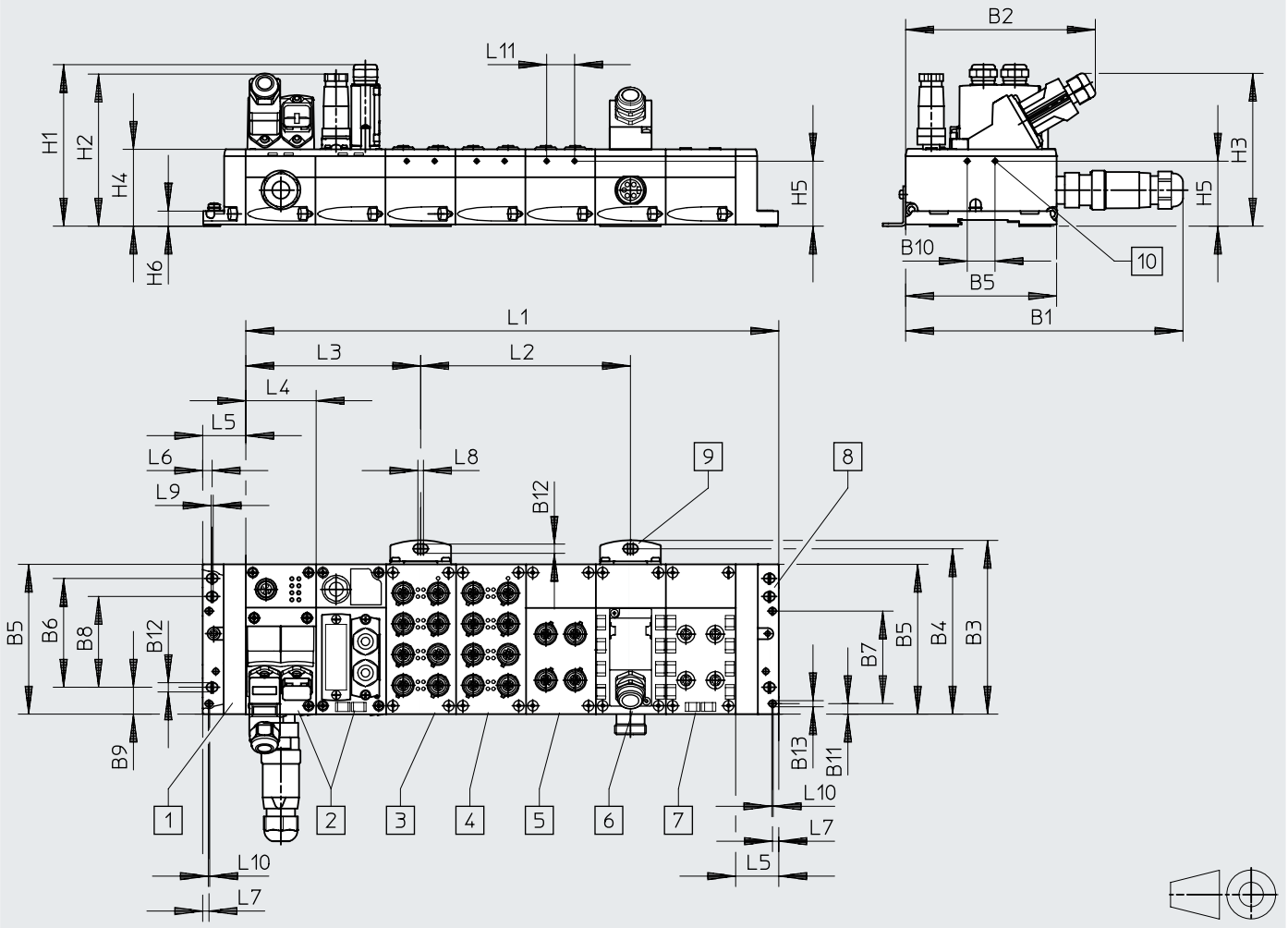

- [1] Left-hand end plate
- [2] Bus node
- [3] Connection block
CPX-M-AB-8-M12X2-5POL
- [4] Connection block
CPX-M-AB-8-M12X2-5POL
- [5] Connection block
CPX-M-AB-4-M12X2-5POL
- [6] Connection block
CPX-AB-1-SUB-BU-25POL
- [7] Connection block
CPX-AB-4-M12-8POL
- [8] Right-hand end plate
- [9] Mounting bracket for wall mounting
- [10] Hole for self-tapping screw
M2.5

Type	B1	B2	B3	B4	B5	B6	B7	B8	B9	B10	B11	B12	B13
CPX-M	199	136	124.9	118.85	108.1	77.95	66.3	65	19.25	20	7.9	6.6	4.4

Type	H1	H2	H3	H4	H5	H6
CPX-M	116	109	109.5	55.1	46.55	10.8

Type	L1 ¹⁾	L2	L3 ²⁾	L4	L5 ³⁾	L6	L7	L8	L9	L10	L11
CPX-M	$n \times 50.1 + 30.4$	150.3	125.25	50.1	30.4	6.75	4.5	4	1.5	1	20

1) n = Number of CPX modules

Data sheet

Dimensions

Download CAD data → www.festo.com

With bus node and valve terminal VTSA/VTSA-F/VTSA-F-CB

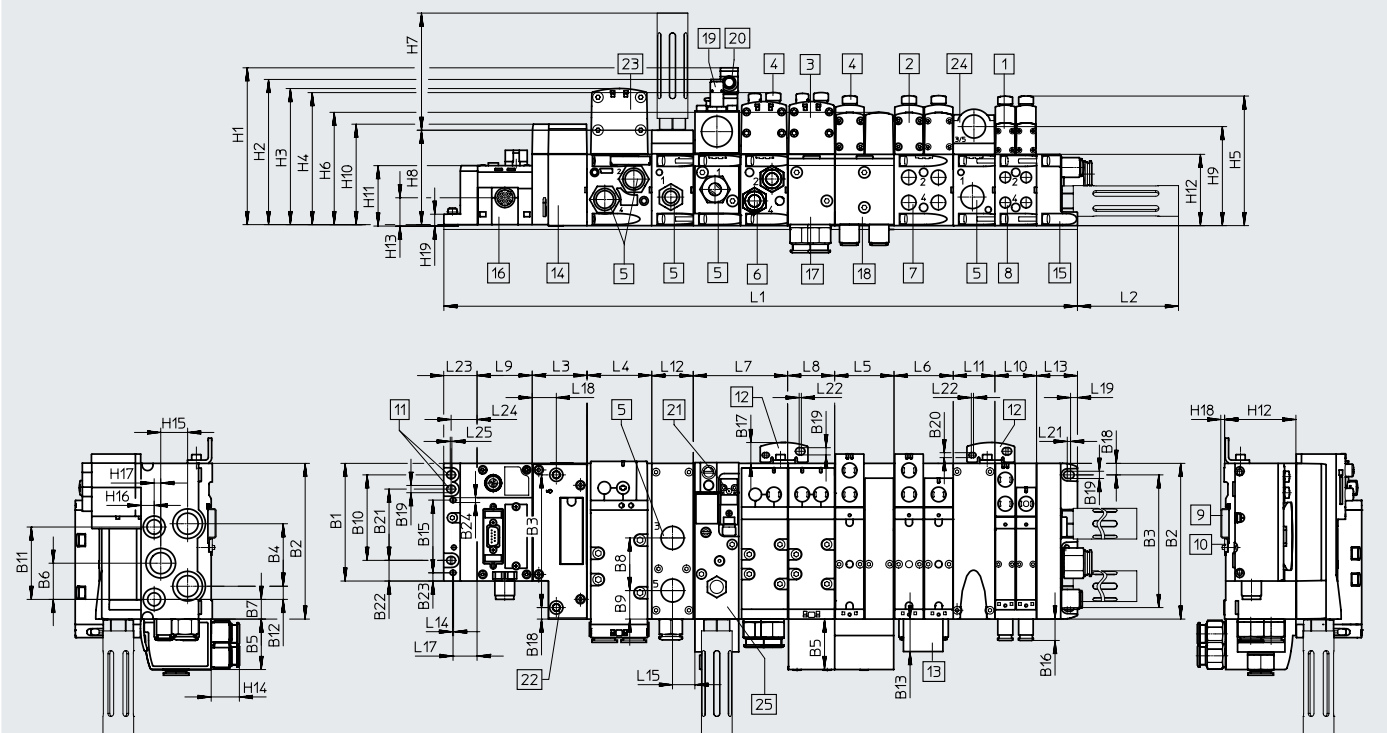

- [1] Solenoid valve, width 18 mm
- [2] Solenoid valve, width 26 mm
- [3] Solenoid valve, width 42 mm
- [4] Cover cap/manual override
- [5] Threaded connection G1/2
- [6] Threaded connection G3/8
- [7] Threaded connection G1/4
- [8] Threaded connection G1/8
- [9] H-rail
- [10] H-rail mounting
- [11] Mounting hole
- [12] Additional mounting bracket
- [13] Inscription label holder
- [14] Pneumatic interface CPX
- [15] End plate
- [16] CPX module/bus node
- [17] 90°-connection plate 43 mm, G3/8
- [18] 90°-connection plate 54 mm, G1/4
- [19] Proximity switch M12x1
- [20] Plug socket M12x1
- [21] Electrical connection to EN 175301-803, type C
- [22] Additional mounting bracket
- [23] Hole for additional mounting, diameter 6.4 2x
- [24] Solenoid valve, width 52 mm
- [25] Supply plate
- [26] Soft-start valve

Dim.	B1	B2	B3	B4	B5	B6	B7	B8	B9	B10	B11	B12	B13	B14	B16	B18	B19	B20	B21	B22	B23	B24
[mm]	107.3	142	121	57	46	33	18	48	26	78	66	12	29.6	23	19.5	10.5	6.6	4.5	65	18.9	7.5	4.4

Dim.	L2	L3	L4	L5	L6	L7	L8	L9	L10	L11	L12	L13	L14	L15	L17	L18	L19	L20	L21	L22
[mm]	92.4	50	n2x59	n01x54	54	n1x43	43	m x 50.1	n02x38	n x 38	38	37.3	1	20.5	22	22	6.3	5.5	3	2

Dim.	L23	L24	L25	H1	H2	H3	H4	H5	H6	H7	H8	H9	H10	H11	H12	H13	H14	H15	H16	H17	H18	H19
[mm]	30.4	23.7	1.5	143.9	133.3	125	121.3	118.2	103	106.8	87	90.3	92.9	55.1	65	25.8	25.7	24.5	12	6	3.5	10.8

Width	L1 ¹⁾
40 mm	30.4 + m x 50.1 + 50 + n02 x 38 + n x 38 + 37.3
26 mm	30.4 + m x 50.1 + 50 + n01 x 54 + n x 38 + 37.3
42 mm	30.4 + m x 50.1 + 50 + n1 x 43 + n x 38 + 37.3
52 mm	30.4 + m x 50.1 + 50 + n2 x 59 + n x 38 + 37.3
Mixture of 18 mm, 26 mm, 42 mm and 52 mm	30.4 + m x 50.1 + 50 + n02 x 38 + n01 x 54 + n1 x 43 + n2 x 59 + n x 38 + 37.3

1) n02 Number of manifold sub-bases 38 mm
 n01 Number of manifold sub-bases 54 mm
 n1 Number of manifold sub-bases 43 mm
 n2 Number of manifold sub-bases 59 mm
 n Number of supply plates (only with end plate with pilot air selector)
 m Number of CPX modules

† Note: This product conforms to ISO 1179-1 and ISO 228-1.

Data sheet

Dimensions

Download CAD data → www.festo.com

With bus node and valve terminal MPA-S

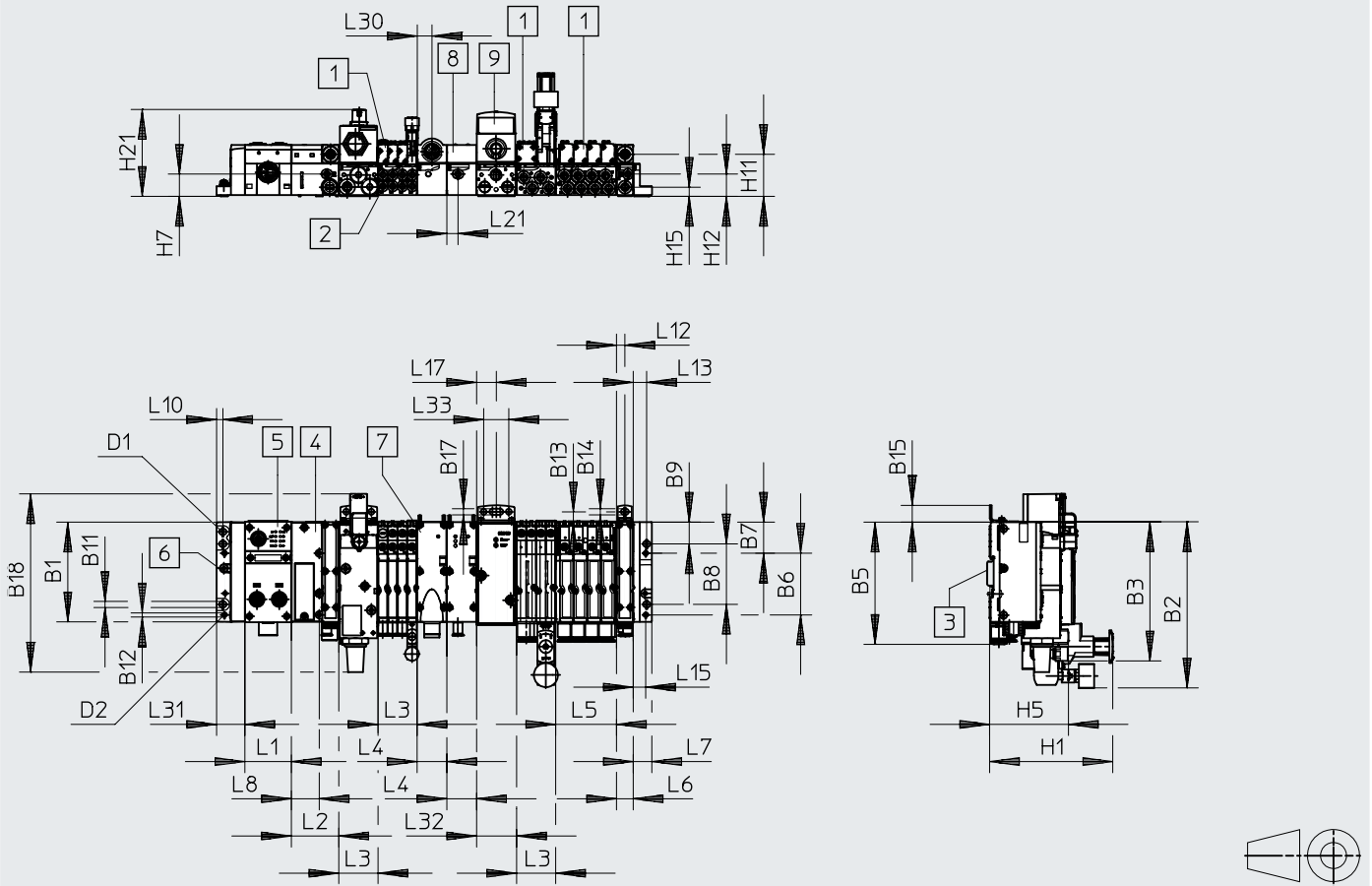

- [1] Solenoid valve
- [2] Working ports
- [3] H-rail
- [4] Pneumatic interface VMPA-FB
- [5] CPX module
- [6] Earthing screw
- [7] Electrical supply plate
- [8] Pressure sensor
- [9] Proportional pressure regulator

Type	B1	B2	B3	B5	B6	B7	B8	B9	B11	B12	B13	B14	B15	B17
MPA-S	107.3	178	149.2	129	66.4	33.5	65	23.5	6.6	4.4	11	6.6	18	6.6

Type	D2	H1	H5	H7	H11	H12	H15	H21	L1 ¹⁾	L2	L3 ²⁾	L4	L5 ³⁾	L6
MPA-S	M4	132.3	84.9	23.9	45.1	23.9	9.8	93.4	m x 50.1	51.3	n x 42	32	o x 65.5	17.9

Type	L7	L8	L10	L12	L13	L14	L15	L17	L21	L30	L31	L32	L33
MPA-S	20	30	6.8	9	14.5	1.5	13.5	21	11.9	15.8	30.4	42	27

1) m = Number of CPX modules
 2) n = number of sub-bases with 4 valve positions (width 10 mm) or 2 valve positions (width 20 mm)
 3) o = number of sub-bases with 4 valve positions (width 14 mm)

Data sheet

Dimensions

Download CAD data → www.festo.com

With bus node and valve terminal MPA-L

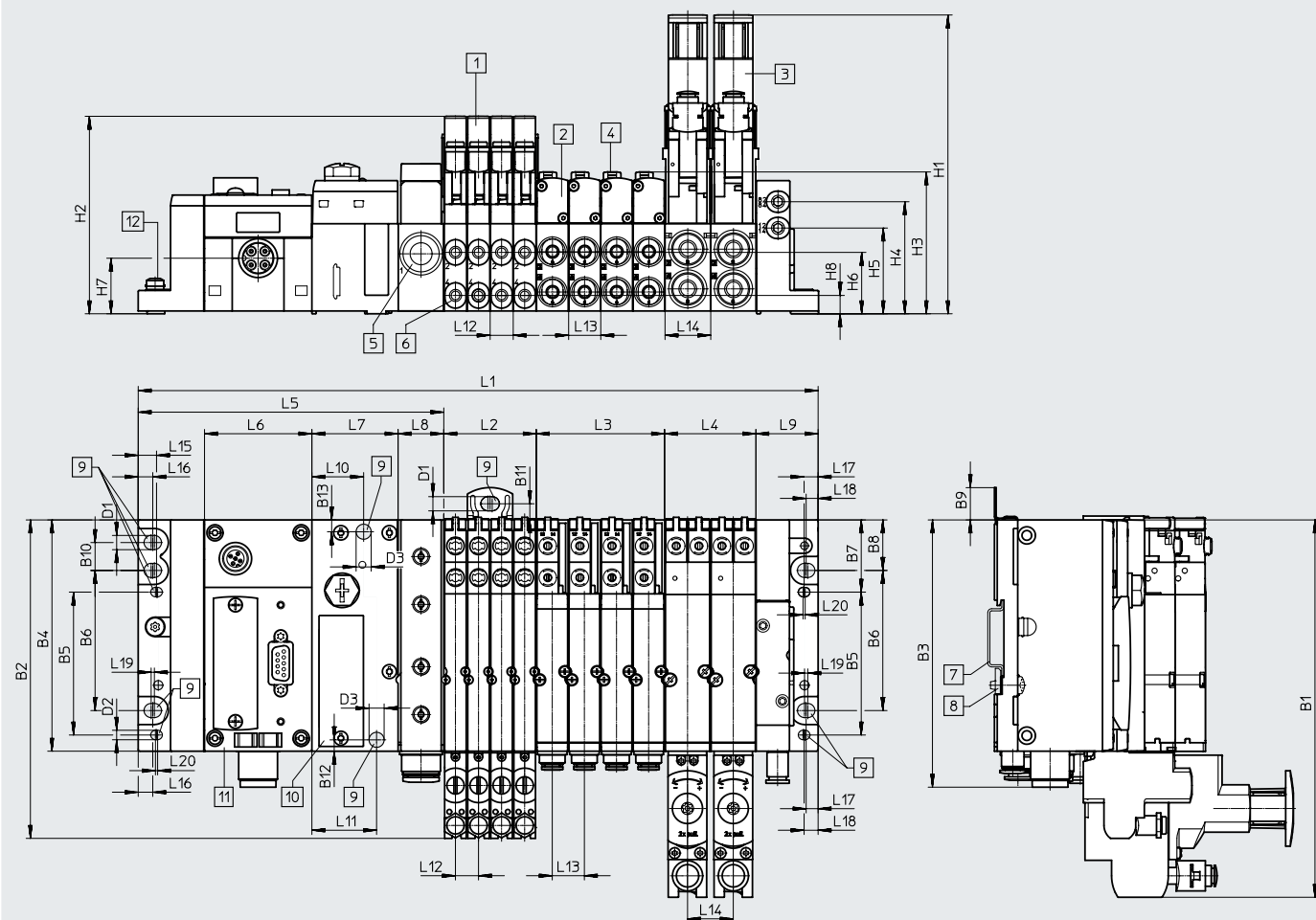

- | | | | |
|---------------------------|---------------------|--|---------------------|
| [1] Solenoid valve VMPA1 | [5] Supply module | [9] Mounting holes | [11] CPX module |
| [2] Solenoid valve VMPA14 | [6] Working ports | [10] Pneumatic interface, CPX terminal | [12] Earthing screw |
| [3] Solenoid valve VMPA2 | [7] H-rail | | |
| [4] Manual override | [8] H-rail mounting | | |

Type	L1 ¹⁾	L2 ¹⁾	L3 ¹⁾	L4 ¹⁾	L5	L6	L7	L8	L9
MPA-L	170.65 + L2 + L3 + L4	m x 10.7	n x 14.9	o x 21.2	142	50	40.1	21.2	28.8



Type	L10	L11	L12	L13	L14	L15	L16	L17	L18	L19	L20
MPA-L	24	30	10.7	14.9	21.2	8.5	6.75	5.55	6.5	1.5	1

Type	B1	B2	B3	B4	B5	B6	B7	B8	B9	B10	B11	B12	B13
MPA-L	175.1	147.8	124	107.3	66.3	65	33.5	23.45	15	12.95	7.5	5.25	5.5

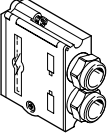

Type	D1	D2	D3	H1	H2	H3	H4	H5	H6	H7	H8
MPA-L	6.6	4.4	7	138.7	92.6	65.7	52	39.8	28.5	25.8	8.5

1) m, n, o = number of sub-bases/valve positions (m = width 10 mm, n = width 14 mm, o = width 20 mm)

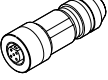
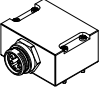
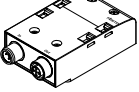
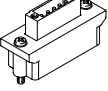
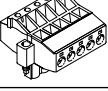
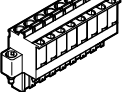
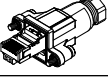
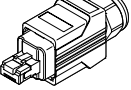
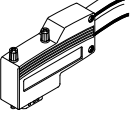
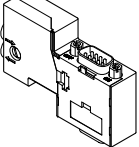



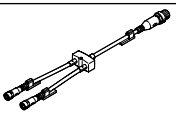

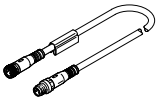
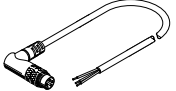
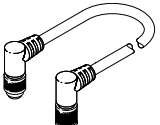
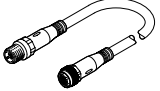
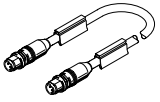
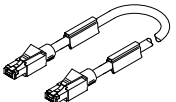
Accessories

Ordering data – Accessories				Part no.	Type
Designation					
Connectors and accessories					
	Sub-D plug for INTERBUS		Incoming	532218	FBS-SUB-9-BU-IB-B
			Outgoing	532217	FBS-SUB-9-GS-IB-B
	Sub-D plug for DeviceNet/CANopen			532219	FBS-SUB-9-BU-2x5POL-B
	Sub-D plug for PROFIBUS DP			532216	FBS-SUB-9-GS-DP-B
	Sub-D plug for CC-Link			532220	FBS-SUB-9-GS-2x4POL-B
	Sub-D plug			534497	FBS-SUB-9-GS-1x9POL-B
	Bus connection M12 adapter (B-coded) for PROFIBUS DP			533118	FBA-2-M12-5POL-RK
	Micro style bus connection, 2xM12 for DeviceNet/CANopen			525632	FBA-2-M12-5POL
	For micro style connection, M12		Socket	18324	FBSD-GD-9-5POL
			Plug	175380	FBS-M12-5GS-PG9
	M12x1 bus connection, 4-pin (D-coded) for Ethernet			543109	NECU-M-S-D12G4-C2-ET
	For FBA-2-M12-5POL-RK and CPX-AB-2-M12-RK-DP, M12x1, 5-pin, straight		Socket	1067905	NECU-M-B12G5-C2-PB
			Plug	1066354	NECU-M-S-B12G5-C2-PB
	Plug M12x1, 4-pin, straight, A-coded	Screw terminal	Connection cross section 0.14 ... 0.5 mm ²		192008
Permissible cable ø 4 ... 6 mm			18666	SEA-GS-7	
Permissible cable ø 6 ... 8 mm			18778	SEA-GS-9	
	Connection block, 9-pin Sub-D socket, 5-pin 7/8" plug for DeviceNet			571052	CPX-AB-1-7/8-DN
	Connection block M12 adapter (B-coded)		For PROFIBUS DP	541519	CPX-AB-2-M12-RK-DP
	Open style bus connection for 5-pin terminal strip for DeviceNet/CANopen			525634	FBA-1-SL-5POL
	Terminal strip for open style connection, 5-pin			525635	FBSD-KL-2x5POL
	8-pin socket		Spring-loaded terminal	565712	NECU-L3G8-C1
			Screw terminal	565710	NECU-L3G8-C2
	RJ45/plug			534494	FBS-RJ45-8-GS
	RJ45 plug, 8-pin, push-pull			552000	FBS-RJ45-PP-GS
	Plug SCRJ, 2-pin, push-pull, for CPX-M-FB45			571017	FBS-SCRJ-PP-GS
	Plug for CAN bus interface, electric axes Sub-D, 9-pin, without terminating resistor			533783	FBS-SUB-9-WS-CO-K
	Sub-D socket with terminating resistor and programming interface		For CANopen	574588	NECU-S1W9-C2-ACO
	Sub-D plug, straight, with terminating resistor and programming interface		For PROFIBUS	574589	NECU-S1W9-C2-APB

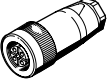
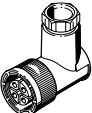
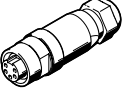
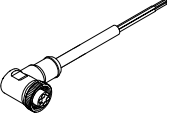

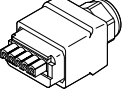

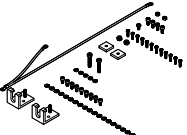
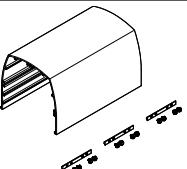
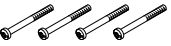

Accessories

Ordering data – Accessories				Part no.	Type	
Designation						
Distributor						
	Modular system for all types of sensor/actuator distributor			–	NEDY-... → Internet: nedy	
	Push-in T-connector	1x plug M8, 4-pin	2x socket M8, 3-pin	8005312	NEDY-L2R1-V1-M8G3-N-M8G4	
		1x plug M12, 4-pin	2x socket M8, 3-pin	8005311	NEDY-L2R1-V1-M8G3-N-M12G4	
			2x socket M12, 5-pin	8005310	NEDY-L2R1-V1-M12G5-N-M12G4	
Connecting cables						
	Modular system for a choice of connecting cables			–	NEBU-... → Internet: nebu	
	Connecting cable M8-M8, straight plug/straight socket		0.5 m	541346	NEBU-M8G3-K-0.5-M8G3	
			1.0 m	541347	NEBU-M8G3-K-1-M8G3	
			2.5 m	541348	NEBU-M8G3-K-2.5-M8G3	
			5.0 m	541349	NEBU-M8G3-K-5-M8G3	
	Connecting cable M12-M12, 5-pin, straight plug/straight socket		1.5 m	529044	KV-M12-M12-1.5	
			3.5 m	530901	KV-M12-M12-3.5	
	Connecting cable for CPX-CTEL, M12-M12, 5-pin, straight plug/straight socket		5 m	574321	NEBU-M12G5-E-5-Q8N-M12G5	
			7.5 m	574322	NEBU-M12G5-E-7.5-Q8N-M12G5	
			10 m	574323	NEBU-M12G5-E-10-Q8N-M12G5	
	Connecting cable M12-M12, 8-pin, straight plug/straight socket		2.0 m	525617	KM12-8GD8G5-2-PU	
	Connecting cable M9, 5-pin, angled plug/open cable end 3-pin		2 m	563711	NEBC-M9W5-K-2-N-LE3	
			5 m	563712	NEBC-M9W5-K-5-N-LE3	
	Connecting cable M9, angled plug/angled socket		0.25 m	540327	KVI-CP-3-WS-WD-0.25	
			0.5 m	540328	KVI-CP-3-WS-WD-0.5	
			2 m	540329	KVI-CP-3-WS-WD-2	
			5 m	540330	KVI-CP-3-WS-WD-5	
			8 m	540331	KVI-CP-3-WS-WD-8	
	Connecting cable M9, Straight plug/straight socket		2 m	540332	KVI-CP-3-GS-GD-2	
			5 m	540333	KVI-CP-3-GS-GD-5	
			8 m	540334	KVI-CP-3-GS-GD-8	
	Connecting cable, straight plug, M12x1, 4-pin, D-coded	Straight plug, M12x1, 4-pin, D-coded	0.5 m	8040446	NEBC-D12G4-ES-0.5-S-D12G4-ET	
				1 m	8040447	NEBC-D12G4-ES-1-S-D12G4-ET
				3 m	8040448	NEBC-D12G4-ES-3-S-D12G4-ET
				5 m	8040449	NEBC-D12G4-ES-5-S-D12G4-ET
				10 m	8040450	NEBC-D12G4-ES-10-S-D12G4-ET
			Straight plug, RJ45, 8-pin	1 m	8040451	NEBC-D12G4-ES-1-S-R3G4-ET
			3 m	8040452	NEBC-D12G4-ES-3-S-R3G4-ET	
			5 m	8040453	NEBC-D12G4-ES-5-S-R3G4-ET	
			10 m	8040454	NEBC-D12G4-ES-10-S-R3G4-ET	
		Open end, 4-wire	5 m	8040456	NEBC-LE4-ES-5-D12G4-ET	
	Connecting cable, Straight plug, RJ45, 8-pin		1 m	8040455	NEBC-R3G4-ES-1-S-R3G4-ET	

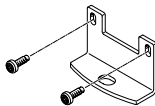
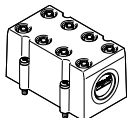
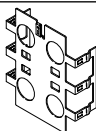
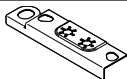
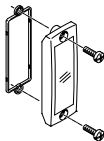
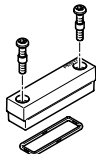
Accessories

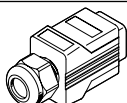
Ordering data – Accessories		Part no.	Type
Designation			
Connectors and accessories – Power supply			
	Plug socket for mains connection M18, straight	For 1.5 mm ²	18493 NTSD-GD-9
		For 2.5 mm ²	18526 NTSD-GD-13.5
	Plug socket for mains connection M18, angled	For 1.5 mm ²	18527 NTSD-WD-9
		For 2.5 mm ²	533119 NTSD-WD-11
	Power supply socket, straight	7/8" connection, 5-pin	543107 NECU-G78G5-C2
		7/8" connection, 4-pin	543108 NECU-G78G4-C2
	7/8" power supply socket, 5-pin, angled socket/open cable end, 5-wire	2 m	573855 NEBU-G78W5-K-2-N-LE5
	Power supply socket M12x1, L-coded, straight	5-pin	8166793 NECL-L12G5-C2-Q10
	Power supply plug M12x1, L-coded, straight	5-pin	8166791 NECL-S-L12G5-C2-Q10
	Power supply socket M12x1, L-coded, angled	5-pin	8166794 NECL-L12W5-C2-Q10
	Power supply plug M12x1, L-coded, angled	5-pin	8166792 NECL-S-L12W5-C2-Q10
	Push-pull power supply socket, plug pattern PP, fulfils requirements to AIDA	5-pin	5195383 NECU-M-PPG5PP-C1-PN
	Straight plug, spring-loaded terminal, for left-hand end plate with system supply	7-pin	576319 NECU-L3G7-C1
Hood			
	Mounting rail for attaching the hood	1000 mm	572256 CAFC-X1-S
	Mounting kit for CPX hood		572257 CAFC-X1-BE
	Hood section for CPX terminal including mounting attachments for connecting several hood sections in series	200 mm	572258 CAFC-X1-GAL-200
		300 mm	572259 CAFC-X1-GAL-300
Screws			
	Screws for mounting the bus node/connection block on the plastic interlinking block	Bus node/metal connection block	550218 CPX-DPT-30X32-S-4X
	Screws for mounting the bus node/connection block on the metal interlinking block	Bus node/plastic connection block	550219 CPX-M-M3x22-4x
		Bus node/metal connection block	550216 CPX-M-M3x22-S-4x
	Screws for mounting an inscription label on the bus node CPX-M-FB45	12 pieces	550222 CPX-M-M2.5X8-12X

Accessories

Ordering data – Accessories		Part no.	Type
Designation			
Mounting			
	Attachment for wall mounting (for long valve terminals, 10 pieces)	Version for manifold sub-bases 529040	CPX-BG-RW-10x
	Attachment for wall mounting, version for metal manifold sub-bases	2 mounting brackets, 4 screws 550217	CPX-M-BG-RW-2X
		1 mounting bracket, 2 screws 2721419	CPX-M-BG-VT-2X
Covers and attachments			
	Cover for CPX-AB-8-KL-4POL (IP65, IP67)	538219	AK-8KL
	<ul style="list-style-type: none"> • 8 cable through feeds M9 • 1 cable through feed for multi-pin plug Fittings kit	538220	VG-K-M9
	Screening plate for M12 connections	526184	CPX-AB-S-4-M12
	Earthing element (5 pieces), for right-hand/left-hand end plate (plastic interlinking blocks)	538892	CPX-EPFE-EV
	Inspection cover, transparent	533334	AK-SUB-9/15-B
	Transparent cover for DIL switch	548757	CPX-AK-P
	Cover for DIL switch	548754	CPX-M-AK-M
	Cover for RJ45 connection	534496	AK-RJ45
	Cover cap for RJ45 push-pull connection	548753	CPX-M-AK-C
	Cover cap for bus connection	2873540	CPX-M-AK-D
	Cover cap for closing off unused connections (10 pieces)	For M8 connections 177672	ISK-M8
		For M12 connections 165592	ISK-M12
	Coding element, so that a coded socket NECU-L3G8 can only be inserted in the matching coded connection block CPX-P-AB-2XKL (96 of each)	For NECU-L3G8 565713	CPX-P-KDS-AB-2XKL

Accessories

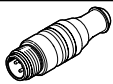
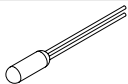
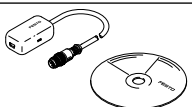
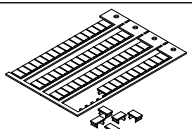
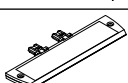
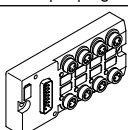
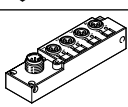
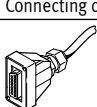
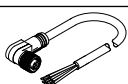
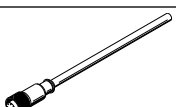
Ordering data – Accessories				
Designation			Part no.	Type
Function blocks				
	Terminating resistor, M12, B-coded for PROFIBUS		1072128	CACR-S-B12G5-220-PB
	PT1000 temperature sensor for cold junction compensation		553596	CPX-W-PT1000
	5-pin M12 to mini USB socket adapter and controller software		547432	NEFC-M12G5-0.3-U1G5
Inscription labels				
	Inscription labels 6x10 mm, 64 pieces, in frame		18576	IBS-6x10
	Inscription label holder for connection block		536593	CPX-ST-1
Multi-pin plug distributor				
	Sub-D plug, 15-pin	8x socket M8, 3-pin	177669	MPV-E/A08-M8
		12x socket M8, 3-pin	177670	MPV-E/A12-M8
	Plug M12, 8 pin	4x socket M8, 3-pin	574586	NEDU-L4R1-M8G3L-M12G8
		6x socket, M8, 3-pin	574587	NEDU-L6R1-M8G3L-M12G8
Connecting cable for multi-pin plug distributor				
	Sub-D socket, 15-pin Open cable end, 15-wire	5 m	177673	KMPV-SUB-D-15-5
		10 m	177674	KMPV-SUB-D-15-10
	Angled socket, M12, 8-pin, Open cable end, 8-wire	Length: 2 m	542256	NEBU-M12W8-K-2-N-LE8
		Length: 5 m	542257	NEBU-M12W8-K-5-N-LE8
		Length: 10 m	570007	NEBU-M12W8-K-10-N-LE8
	Straight socket, M12, 8-pin, Open cable end, 8-wire	Length: 2 m	525616	SIM-M12-8GD-2-PU
		Length: 5 m	525618	SIM-M12-8GD-5-PU
		Length: 10 m	570008	SIM-M12-8GD-10-PU