

Valve terminals VTOC

FESTO



Valve terminals VTOC

Overview – Valve terminals

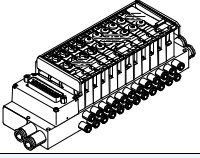
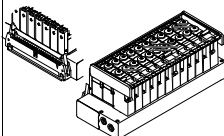
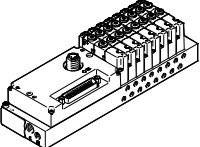
Design	Type code	Description	→ Page/ Internet
Valve terminal VTOC with multi-pin plug connection, Sub-D			
	SD	<ul style="list-style-type: none"> • Sub-D, 25-pin • Sub-D, 44-pin 	25
Valve terminal VTOC with multi-pin plug connection, flat cable			
	RC	<ul style="list-style-type: none"> • Flat cable, 26-pin • Flat cable, 40-pin • Flat cable, 50-pin 	25
Valve terminal with I-Port interface, interlock/IO-Link			
	LK/PT	<ul style="list-style-type: none"> • I-Port interface: plug M12, 5-pin • Sub-D, 44-pin • IO-Link 	27

Valve terminals VTOC

Key features

FESTO

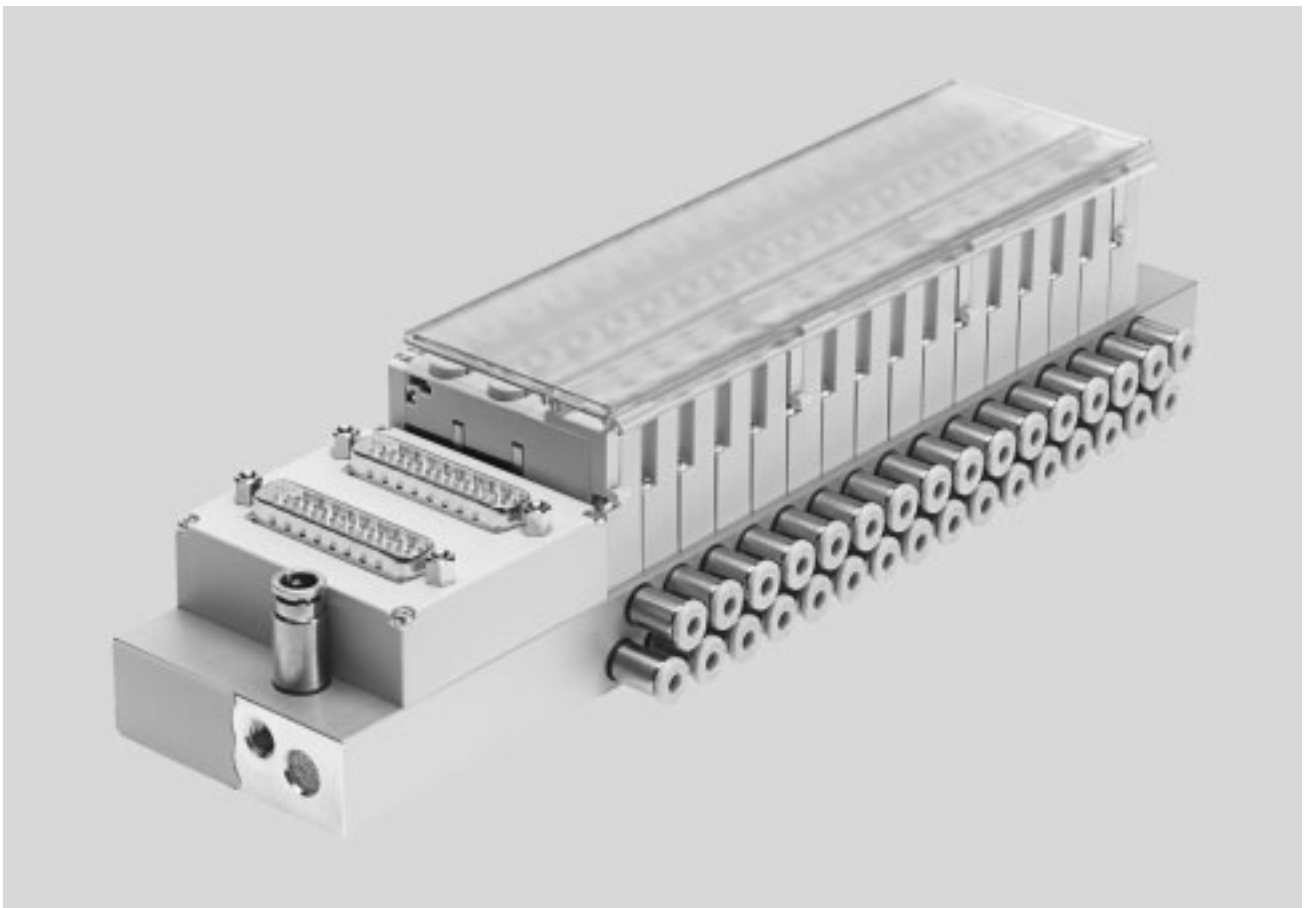

Innovative

- Valve terminal for a wide range of pneumatic applications
- Weight-optimised metal manifold rail
- Space-saving thanks to 2x3/2-way valves at one valve position
- Great flexibility during planning, assembly and operation
- Configurable manifold rails (pneumatic and electric connections)

Versatile

- Provides 2 ... 24 valve positions on one terminal
- Flexibility of the pneumatic working ports provides a practical solution to different requirements
- Wide range of electrical outlet directions
- Multi-pin plug connection with Sub-D plug or flat cable
- I-Port interface with interlock for fieldbus node (CTEU)
- IO-Link mode for direct connection to a higher-level IO-Link master

Reliable

- Manual override
- Durable
- Sturdy thanks to simple structure

Easy to mount

- Ready-to-install and tested unit
- Lower ordering, installation and commissioning costs
- Easy valve assembly



Note

Ordering system for valve terminal VTOC

→ Internet: vtoc

Valve terminals VTOC

Key features – Valve terminals

FESTO

Valve terminal with multi-pin plug connection

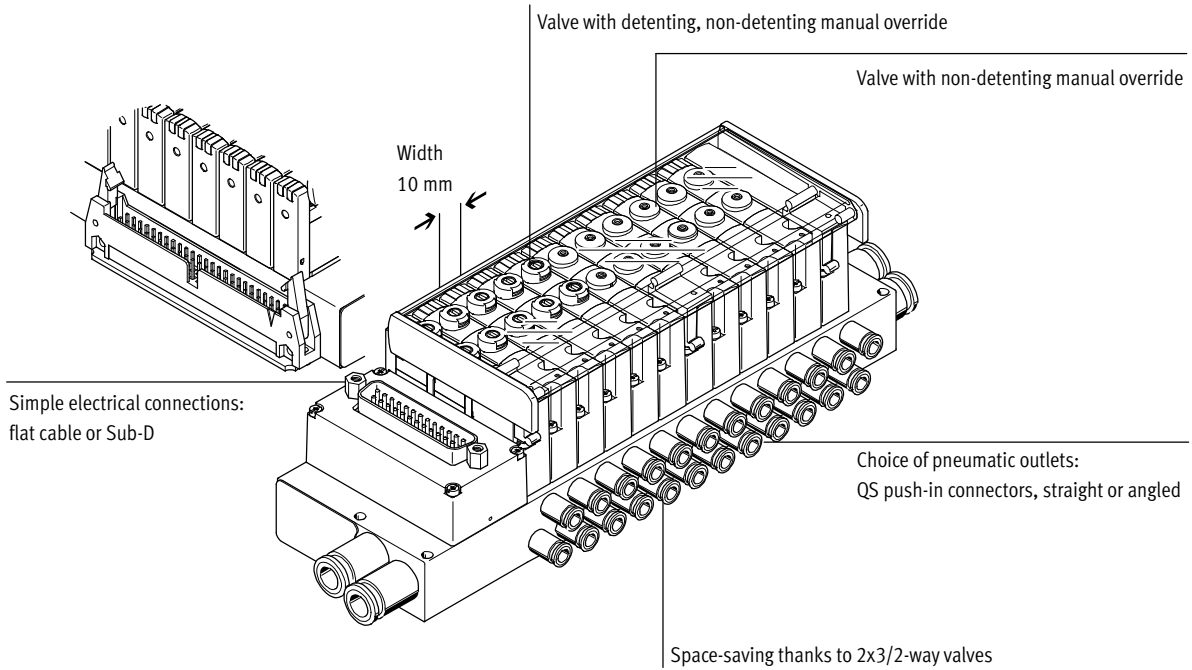

Valve terminal with I-Port interface, interlock/IO-Link

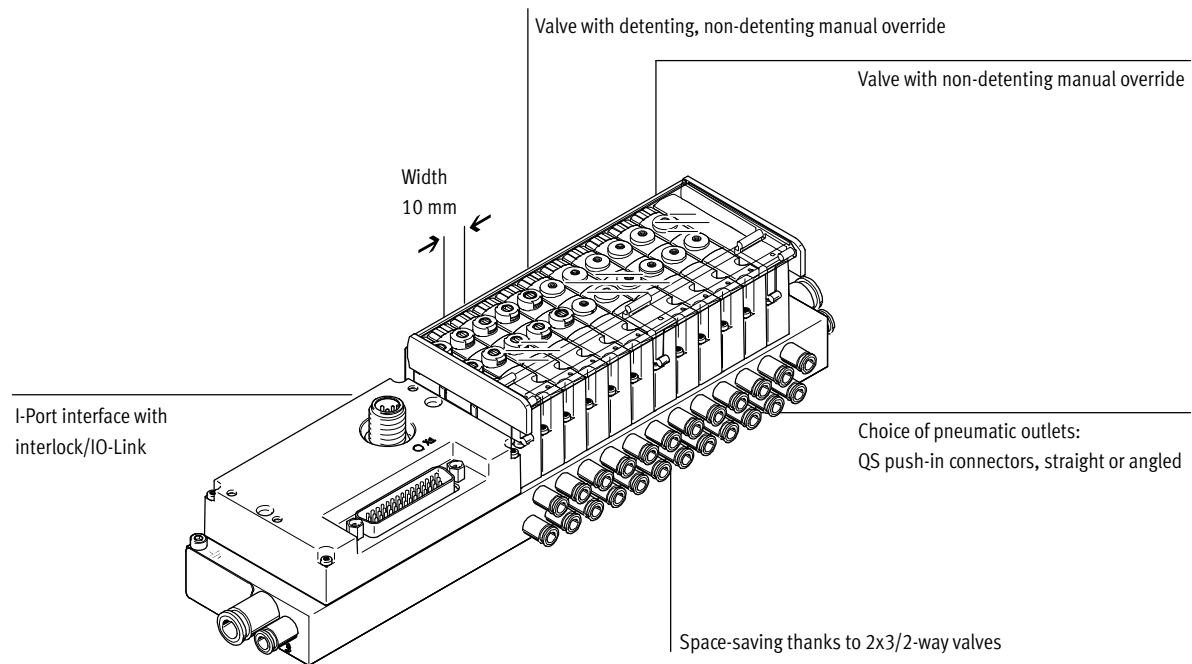

Equipment options

Valve functions

- 2x3/2-way valve, single solenoid, normally closed
- Valve with non-detenting manual override
- Valve with detenting, non-detenting manual override
- 2 ... 24 valve positions/
max. 48 solenoid coils

Electrical connection options

- Variable multi-pin plug connection: Sub-D or flat cable
- I-Port interface with interlock for fieldbus node (CTEU)
- IO-Link mode for direct connection to a higher-level IO-Link master

Valve terminals VTOC

Key features

Integration of the I-Port interface/IO-Link

Different fieldbus nodes are used for integration into the control systems of various manufacturers.

The following protocols are supported with the compatible fieldbus node

- CTEU:
- CANopen
 - DeviceNet

- EtherCAT
- CC-Link
- PROFIBUS

Use of the electrical sub-base CAPC permits decentralised installation of fieldbus nodes CTEU on a further valve terminal or input modules with I-Port interfaces (→ installation system CTEU/CTEL)

System overview, example

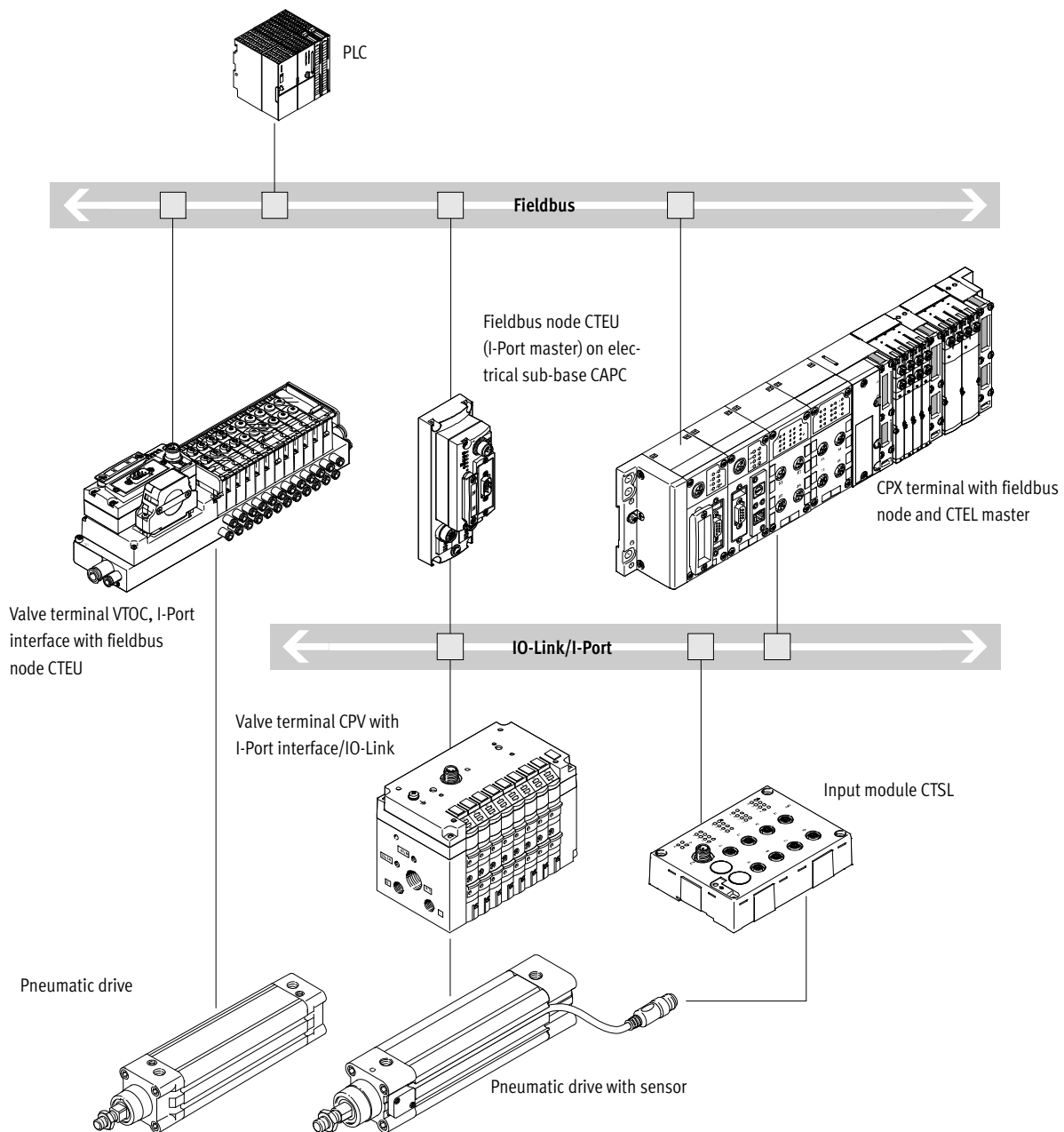

- Communication with the higher-order controller via fieldbus

- Use the fieldbus node CTEU compatible with the fieldbus protocol

- Up to 64 inputs/outputs (solenoid coils), depending on the valve terminal

Valve terminals VTOC

Peripherals overview

Overview – Valve terminal VTOC with multi-pin plug connection, Sub-D

- Up to 24 valve positions/
48 solenoid coils
- Flat cable connection type, code: RC
- Sub-D plug connection type,
code: SD

Valve terminals with electrical multi-pin plug connection are available with 2 to max. 24 valve positions. Each valve position can either be equipped with a valve body or a blanking plate.

Only valve bodies containing two 3/2-way single solenoid valves are available.

A maximum of 48 solenoid coils can be actuated via the electrical multi-pin plug connection.

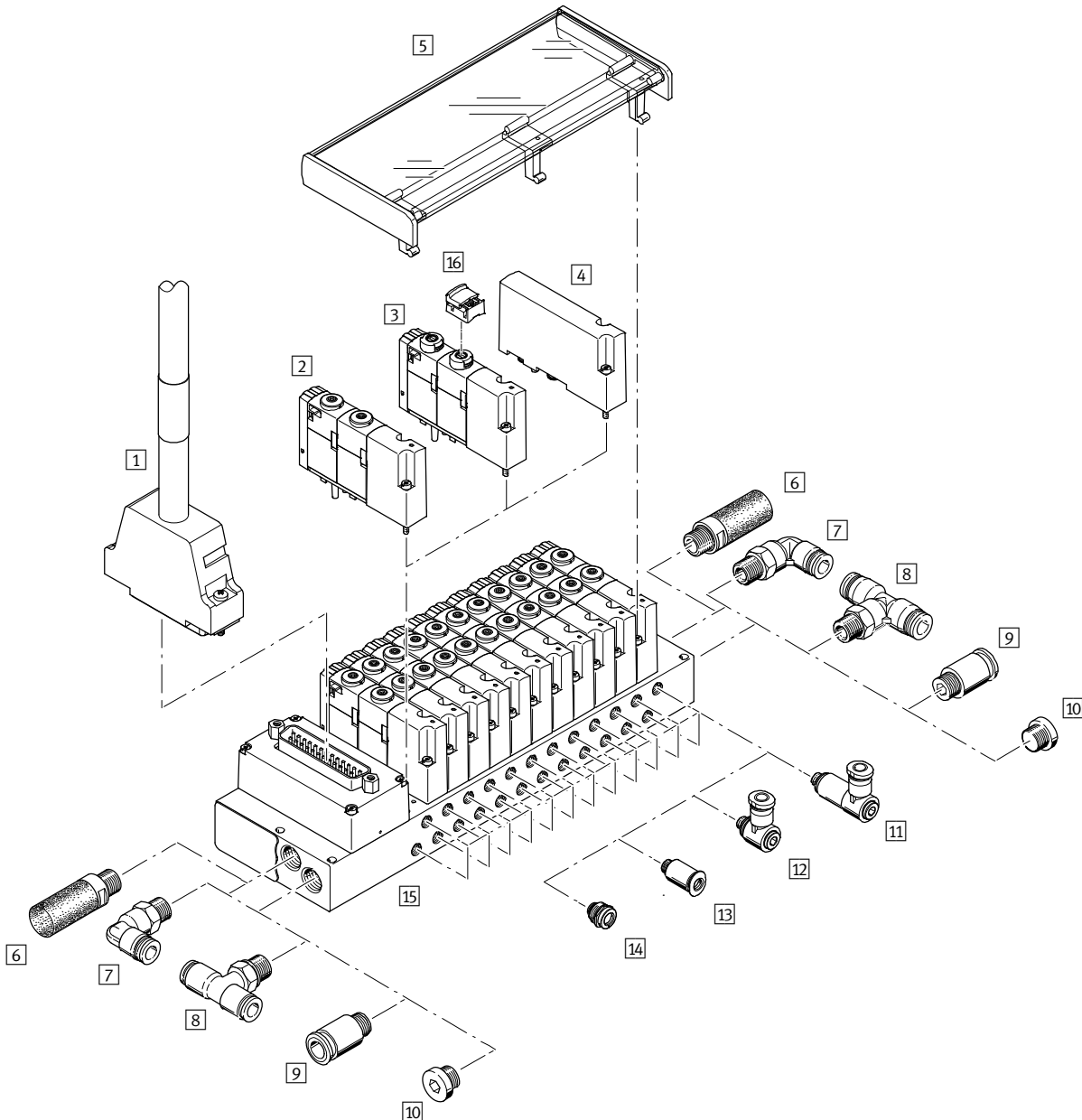

Valve terminals VTOC

Peripherals overview

FESTO

Accessories				
	Type	Brief description	→ Page/ Internet	
1	Connecting cable	KMP6/ NEBV	For multi-pin plug connection, with Sub-D plug, 25-pin or 44-pin	37
2	Solenoid valve, single solenoid	VOVC	With non-detenting manual override	37
3	Solenoid valve, single solenoid	VOVC	With detenting, non-detenting manual override	37
4	Blanking plate	VABB	For vacant position	37
5	Inscription label holder	ASCF	For labelling the valves/manual override cover	38
6	Silencer	U	For fitting in exhaust ports	38
7	Elbow connector	QSL	For connecting to the air supply or exhaust	38
8	T-fitting	QST	For connecting to the air supply or exhaust	38
9	Straight fitting	OS	For connecting to the air supply or exhaust	38
10	Blanking plug	B	For sealing the air supply or exhaust port	37
11	Push-in L-fitting, long	QSMLLV	Long elbow connector for working ports	38
12	Push-in L-fitting	QSMLV	Elbow connector for working ports	38
13	Push-in fitting	QS	Straight push-in fitting for working ports	38
14	Push-in fitting	QSIMG	Straight countersunk push-in fitting for working ports (compact)	–
15	Manifold rail	VABB	With multi-pin plug connection for max. 24 valve positions	–
16	Cover	VAMC	For manual override, detenting (without accessories)	37

Valve terminals VTOC

Peripherals overview

Overview – Valve terminal VTOC with I-Port interface, interlock/IO-Link

- Up to 24 valve positions/
48 solenoid coils
- I-Port interface with interlock
connection type, code: PT
- IO-Link connection type, code: LK

The electrical supply/transmission of communication data takes place via an M12 plug.
The valve terminal can be equipped with 2 ... 24 valves.

Only valve bodies containing two 3/2-way single solenoid valves are available.

The following protocols are supported in connection with the associated CTEU fieldbus node:

- DeviceNet
- CANopen
- PROFIBUS DP
- EtherCat
- CC-Link

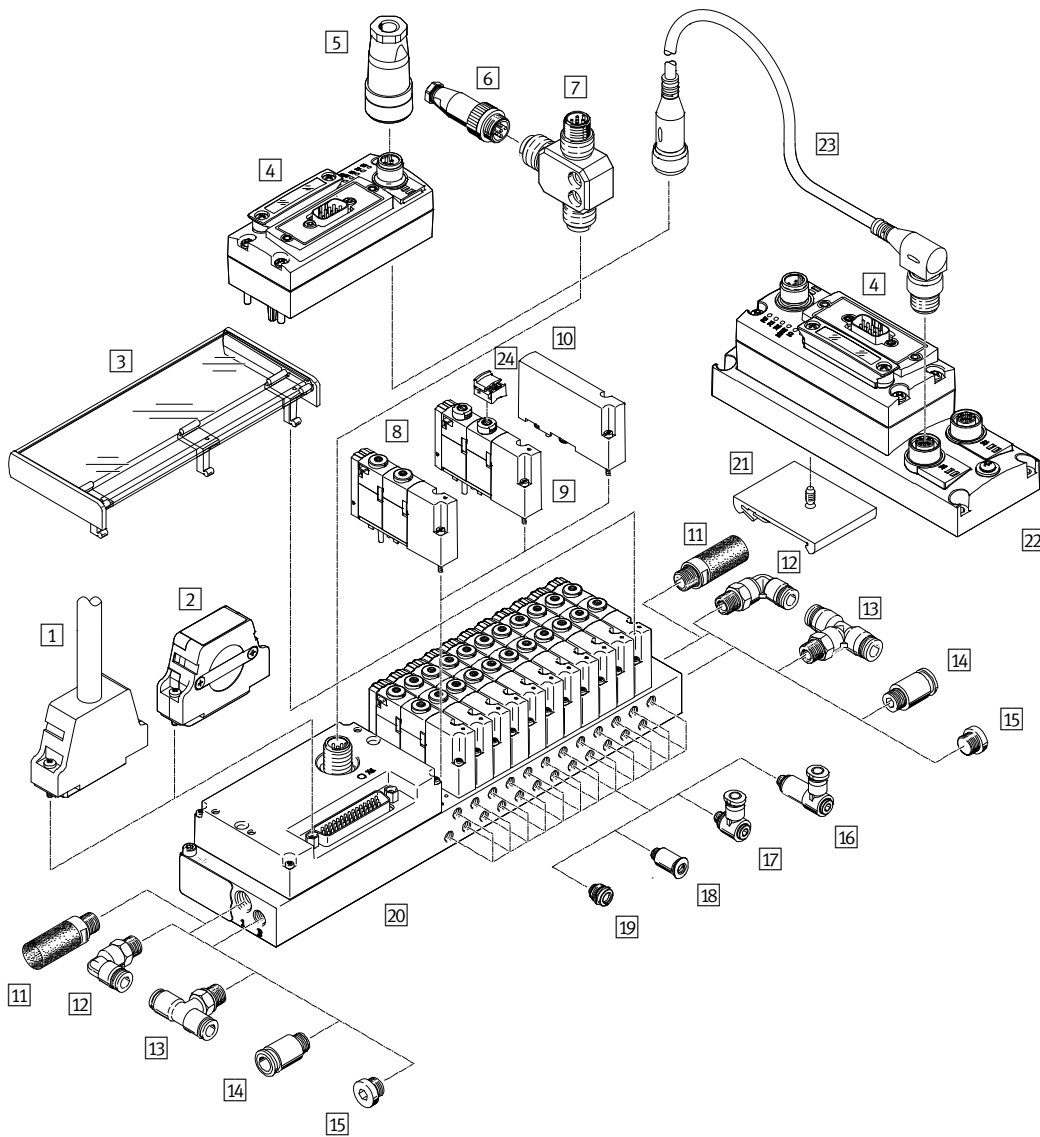

Valve terminals VTOC

Peripherals overview

FESTO

Accessories				
	Type	Brief description	→ Page/ Internet	
1	Connecting cable	KMP6/ NEBV	For multi-pin plug connection, with Sub-D plug, 44-pin	37
2	Plug socket	NEFF	For bypassing the interlock function	40
3	Inscription label holder	ASCF	For labelling the valves/manual override cover	38
4	Fieldbus	CTEU	Fieldbus node	39
5	Plug socket	FBSD/ NTSD	For fieldbus node CTEU	40
6	Plug	SEA	Straight, for T-adapter FB-TA	40
7	T-adapter	FB-TA	For IO-Link and load supply	40
8	Solenoid valve, single solenoid	VOVC	With non-detenting manual override	37
9	Solenoid valve, single solenoid	VOVC	With detenting, non-detenting manual override	37
10	Blanking plate	VABB	For vacant position	37
11	Silencer	U	For fitting in exhaust ports	38
12	Elbow connector	QSL	For connecting to the air supply or exhaust	38
13	T-fitting	QST	For connecting to the air supply or exhaust	38
14	Straight fitting	OS	For connecting to the air supply or exhaust	38
15	Blanking plug	B	For sealing the air supply or exhaust port	37
16	Push-in L-fitting, long	QSMLLV	Long elbow connector for working ports	38
17	Push-in L-fitting	QSMLV	Elbow connector for working ports	38
18	Push-in fitting	QS	Straight, for working ports	38
19	Push-in fitting	QSIMG	Straight countersunk push-in fitting for working ports (compact)	–
20	Manifold rail	VABB	With I-Port interface/IO-Link, interlock	–
21	H-rail mounting	CAFM	For electrical connecting plate CAPC	38
22	Electrical connecting plate	CAPC	For connecting a second device with I-Port interface	40
23	Connecting cable	NEBU	–	40
24	Cover	VAMC	For manual override, detenting (without accessories)	37

Valve terminals VTOC

Peripherals overview

Pin allocation variants											
Flat cable	Number of valve positions	Top left (LT)				Bottom left (LB)		Top right (RT)			
		26 pins 1-way	26 pins 2-way	50 pins 1-way	50 pins 2-way	26 pins 1-way	26 pins 2-way	40 pins 1-way	40 pins 2-way	50 pins 1-way	50 pins 2-way
	4-12	V14	-	-	-	V8	-	-	-	-	-
	8-12	-	-	V11 ¹⁾	-	-	-	-	-	V10 ¹⁾	-
	6-10	-	-	-	-	-	-	V9 ¹⁾²⁾	-	-	-
	13-24	-	V15	-	-	-	V17	-	-	-	-
	16-24	-	-	-	V16 ¹⁾	-	-	-	-	-	-
	16-20	-	-	-	-	-	-	-	V18 ¹⁾²⁾	-	-
	18-24	-	-	-	-	-	-	-	-	-	V19 ¹⁾

- 1) Individual ground
- 2) Not bi-directional

Overview of electrical connections

Valve terminal with flat cable connection on top

- Flat cable connection type, code: RC
 - Connection direction:
 - Top left (code LT)
 - Top right (code RT)
- A total of 10 pin allocation variants are available. Detailed pin allocation → p. 20

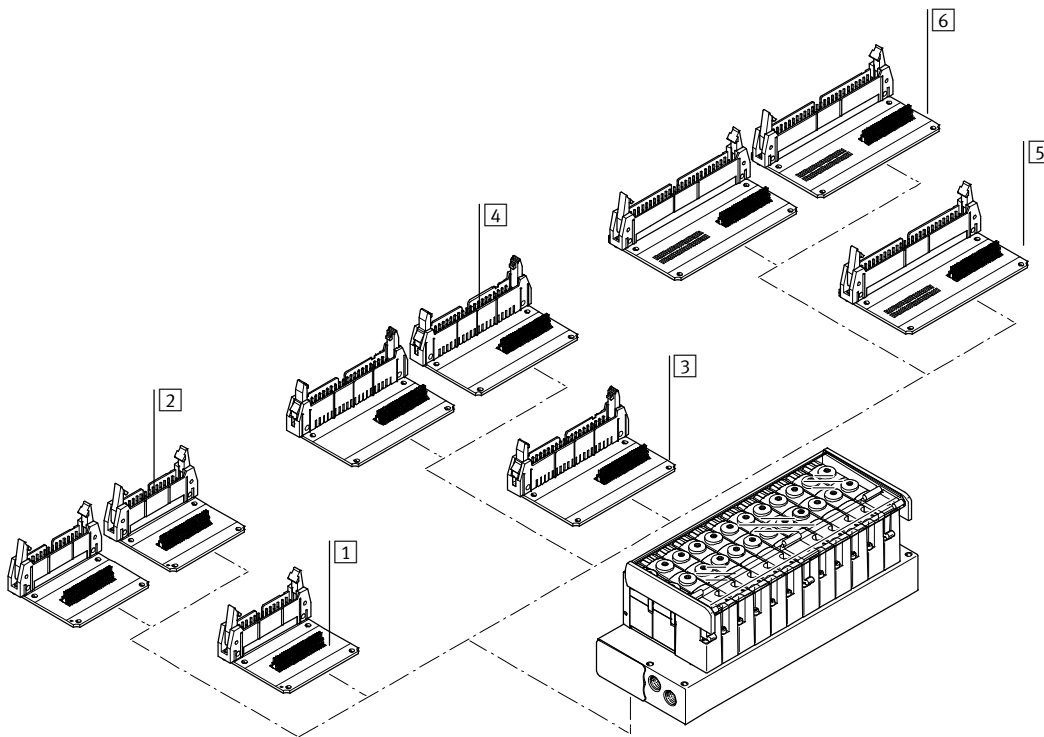

Accessories				
	Code	Brief description	Number of valve positions	Variants
1	LT	1-way, top left	4-12	V14
2		2-way, top left	13-24	V15
3	RT	1-way, top right	6-10	V9
4		2-way, top right	16-20	V18
5	RT	1-way, top right	8-12	V10
6		2-way, top right	18-24	V19
5	LT	1-way, top left	8-12	V11
6		2-way, top left	16-24	V16

Valve terminals VTOC

Peripherals overview

Overview of electrical connections

Valve terminal with flat cable connection underneath

- Flat cable connection type, code: RC
 - Connection direction:
 - Bottom left (code LB)
- A total of 10 pin allocation variants are available.
- Detailed pin allocation → p. 20

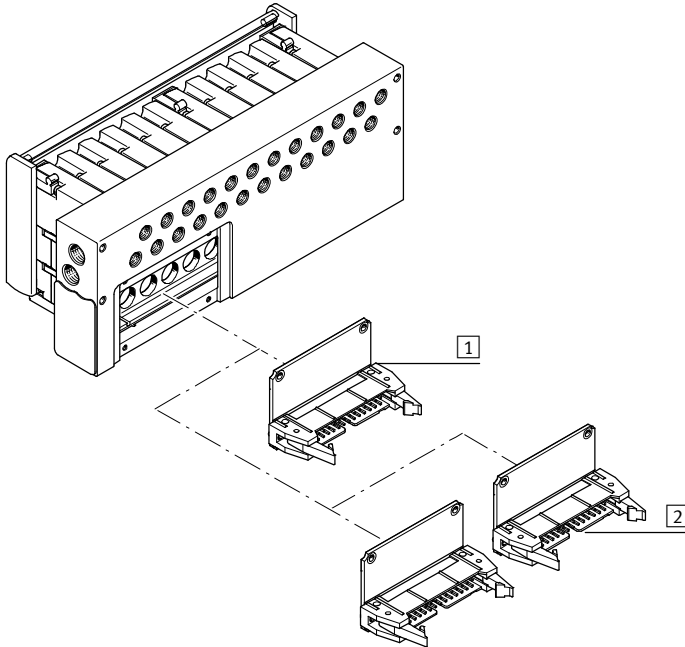

Accessories				
	Code	Brief description	Number of valve positions	Variants
1	LB	1-way, bottom left	4–12	V8
2		2-way, bottom left	13–24	V17

Valve terminals VTOC

Peripherals overview

Pin allocation variants										
Sub-D	Number of valve positions	Top left (LT)								Top right (RT)
		25 pins 1-way			25 pins 2-way	25 pins 2-way	44 pins 1-way	44 pins 2-way		44 pins 1-way
	2-12	V2	V3 ²⁾	V1	-	-	-	-	-	-
	4-12	-	-	-	-	V12 ¹⁾	-	-	-	-
	13-21	-	-	-	-	-	V5	-	-	V13
	13-22	-	-	-	-	-	-	V7 ¹⁾	V6 ¹⁾²⁾	-
	13-24	-	-	-	V4	-	-	-	-	-

- 1) Individual ground
- 2) Not bi-directional

Overview of electrical connections

Valve terminal with Sub-D connection on top

- Sub-D connection type, code: SD
- Connection direction:
 - Top left (code LT)
 - Top right (code RT)
- A total of 9 pin allocation variants are available.
- Detailed pin allocation → p. 18

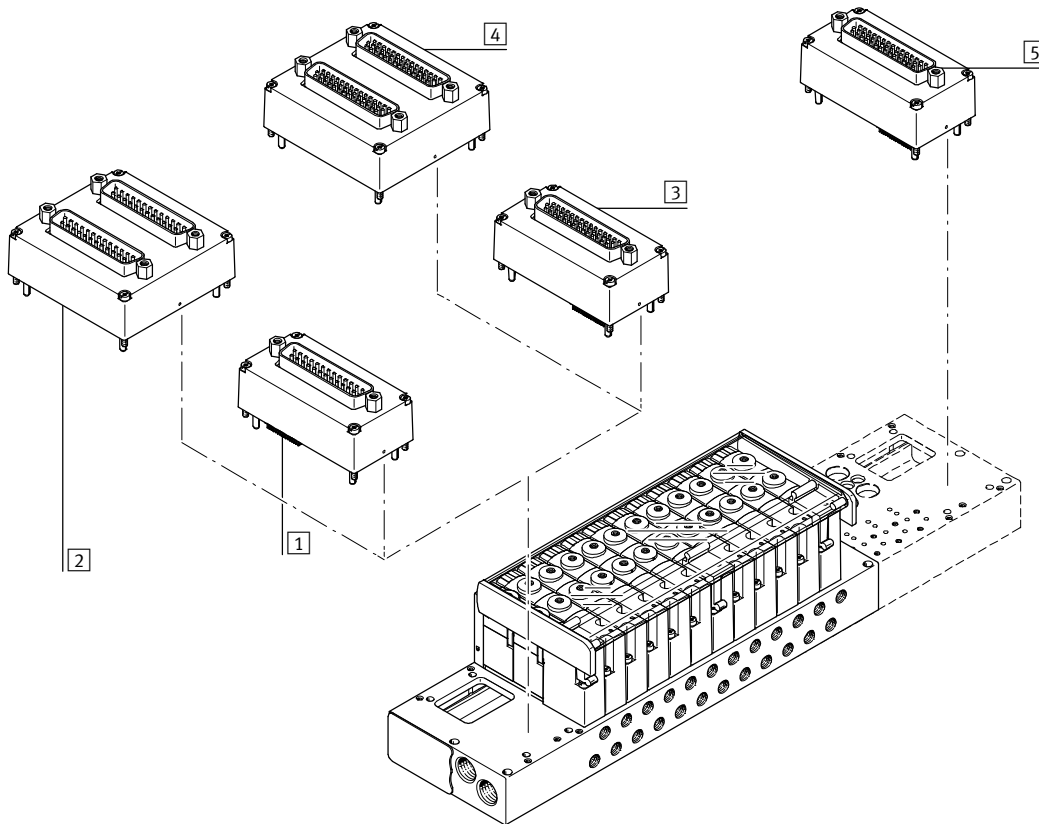

Accessories					
	Code	Brief description	Number of valve positions	Variants	
1	Sub-D, 25-pin	LT	1-way, top left	2...12	V1, V2, V3
2	Sub-D, 25-pin		2-way, top left	13...24	V4
				4...12	V12
3	Sub-D, 44-pin	LT	1-way, top left	13...21	V5
4	Sub-D, 44-pin		2-way, top left	13...22	V6, V7
5	Sub-D, 44-pin	RT	1-way, top right	13...20	V13

Valve terminals VTOC

Key features – Pneumatic components

Design

The valves are mounted on the metal manifold rail using two screws. The use of 2x3/2 directional control valves per valve position guarantees optimum use of space with maximum performance. The valves only differ in

the type of manual override. The assembled and tested units or individual components as modules enable a custom configuration.

Blanking plates can be replaced by valves at a later date. The existing dimensions, mounting points and the

pneumatic and electrical installation do not change.

Valve function

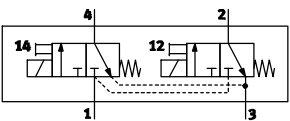
Code	Circuit symbol	Width	Description
		10 mm	
K		■	2x3/2-way valve, single solenoid <ul style="list-style-type: none"> • Mechanical spring return • Non-reversible

Valve terminals VTOC

Key features – Pneumatic components

Fittings

Ports 1/3

Wide range of connection sizes:

- Threaded connection M7, G $\frac{1}{8}$, $\frac{1}{8}$ NPT
- Push-in connector QS6, QS8, QS $\frac{3}{8}$ or QS $\frac{1}{4}$ (compressed air supply)
- Push-in connector QS6, QS $\frac{1}{4}$ or silencer (exhaust air)

Choice of connection types for port 1, compressed air supply and port 3, exhaust air:

- Straight
- Elbow connector
- T-fitting

Flexible connection positions for the compressed air supply and exhaust:

- At both ends
- To the left
- To the right

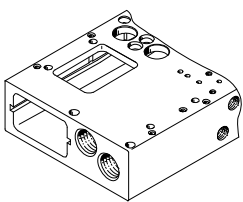
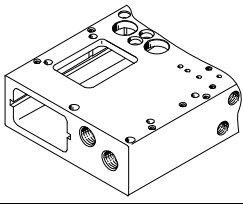
Ports 1/3		
Connection direction: front	Code	Description
	-G18	Manifold block G $\frac{1}{8}$ (diagram shows example of Sub-D electrical connection on left) Basis for design: <ul style="list-style-type: none"> • Push-in connector QS8 • Push-in connector QS$\frac{3}{8}$"
	-M7	Manifold block M7 (diagram shows example of Sub-D electrical connection on left) Basis for design: <ul style="list-style-type: none"> • Push-in connector QS6 • Push-in connector QS$\frac{1}{4}$ • Exhaust port via push-in fitting or silencer

Valve terminals VTOC

Key features – Pneumatic components

Fittings

Ports 2/4

Wide range of connection sizes:

- Threaded connection M5
- 10-32 UNF
- Push-in connector QS3, QS4 or 1/8"

Outlet direction:

- To the front
- Underneath

Connection on the valve (port 2/4)

Outlet direction to the front

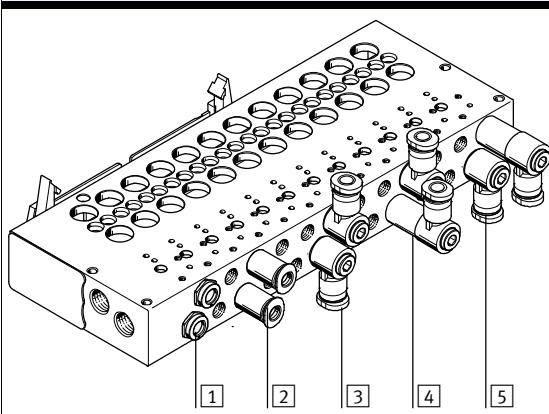

	Code	Description
1	X	Straight countersunk outlet (compact)
2	-	Straight outlet
3	FB	Angled outlet, upwards/downwards
4	FA	Angled outlet, upwards
5	FC	Angled outlet, downwards

Outlet direction underneath

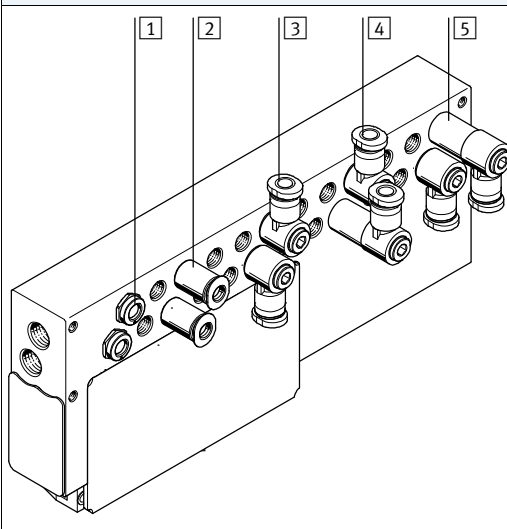

1	X	Straight countersunk outlet (compact)
2	U	Straight outlet
3	UB	Angled outlet, to the front/rear
4	UA	Angled outlet, to the front
5	UC	Angled outlet, to the rear

Valve terminals VTOC

Key features – Display and operation

Manual override (MO)

Manual override with automatic return (non-detenting)

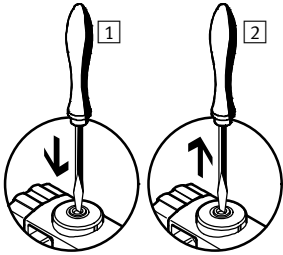

1 Press in the stem of the manual override with a pointed object or screwdriver. The valve switches.

2 Remove the pointed object or screwdriver. Spring force pushes the manual override back. The valve returns to its normal position.

Manual override with lock (non-detenting/detenting)

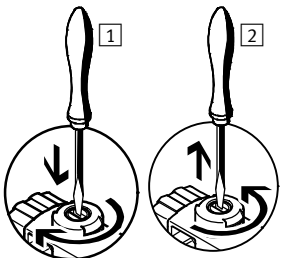

1 Press in the stem of the manual override with a screwdriver until the valve switches and then turn the stem clockwise by 90° until the stop is reached. The valve remains switched.

2 Turn the stem anti-clockwise by 90° until the stop is reached and then remove the screwdriver. Spring force pushes the manual override back. The valve returns to its normal position.



Note

VTOC provides two valves with the same valve function but different types of manual override. There is no provision for subsequent modification of the type of manual override (e.g. by attaching a cover).

Identification system

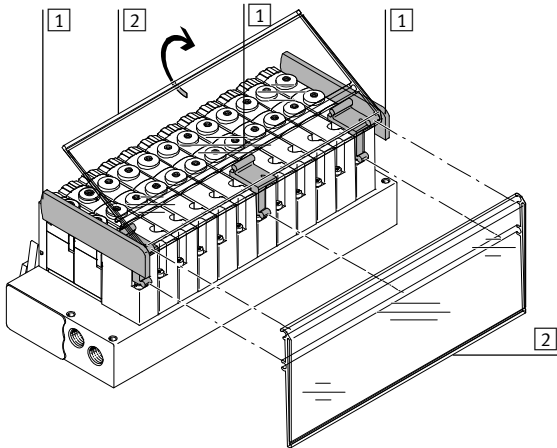

1 Retainer for inscription label holder
The retainer for the inscription label holder is fastened to the valves with one screw and enables the inscription label holder to be mounted in two different directions. The retainers at the side are flanged to prevent the inscription label sliding out.

2 Inscription label holder
A transparent inscription label holder ASCF-H-L2 (code F/T in the order code) can be mounted for labelling the valves. Inscription labels can be inserted in the holders for labelling purposes. Templates for printing the inscription label are available on request.

Mounting – Valve terminal

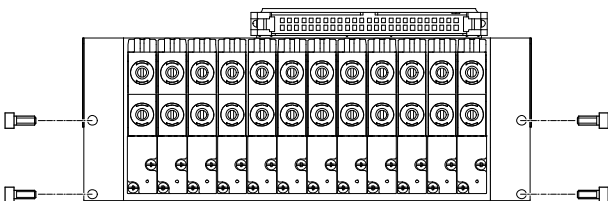

Sturdy terminal assembly thanks to:

- Four through-holes for wall mounting (hole \varnothing : 3.3 mm)
- Four holes with thread on the reverse side:
 - Thread M3
 - Thread M4

- Thread 8-32 UNC
- Thread 10-32 UNC-2B

Valve terminals VTOC

Key features – Electrical components

Electrical connection

Multi-pin plug

The following multi-pin plug connections are available for the valve terminal VTOC:

- Sub-D multi-pin plug connection (25-pin, 1-way or 2-way)
- Sub-D multi-pin plug connection (44-pin, 1-way or 2-way)
- Flat cable plug (26-pin, 1-way or 2-way)
- Flat cable plug (40-pin, 1-way or 2-way)
- Flat cable plug (50-pin, 1-way or 2-way)

The multi-pin plug connection is available with 19 different pin allocation variants.

Other variants on request.

Connection directions:

- Sub-D connection (top left/right)
- Flat cable (top/bottom left, top/bottom right)

Control signals from the controller to the valve terminal are transmitted via the multi-core pre-assembled cable, which substantially reduces installation time.

The valves are switched by means of positive or negative logic (positive switching or negative switching).

Mixed operation is not permitted.

Each pin on the multi-pin plug can actuate exactly one solenoid coil. If the maximum configurable number of valve positions is 24, this means that 48 valves can be addressed.

Explanation of pin allocation (V12)

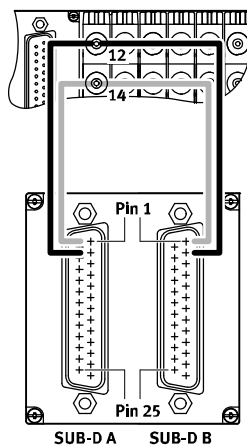

The example shows the pin allocation code V12. The solenoid coils are wired in ascending order of the valves so that solenoid coil 14 occupies the low-value pin and solenoid coil 12 the next pin of both Sub-D connections:

- Pin 1 of Sub-D A and Sub-D B at valve position 1, coil 14.
 - Pin 2 of Sub-D A and Sub-D B at valve position 1, coil 12.
- The following tables show the different pin allocation variants.

The circuitry may differ from the example depending on the multi-pin plug connection chosen.

Valve terminals VTOC

Key features – Electrical components



Pin allocation – Sub-D plug, 25-pin

Pin	-V1		-V2		-V3		-V4				-V12			
	Sub-D A ¹⁾		Sub-D B ²⁾		Sub-D A ¹⁾		Sub-D B ²⁾		Sub-D A ¹⁾		Sub-D B ²⁾			
1	VP1	12	VP1	14	VP1	14-	VP1	14	VP13	14	VP1	14	VP1	14
2	VP1	14	VP2	14	VP2	14-	VP1	12	VP13	12	VP1	12	VP1	12
3	VP2	12	VP3	14	VP3	14-	VP2	14	VP14	14	VP2	14	VP2	14
4	VP2	14	VP4	14	VP4	14-	VP2	12	VP14	12	VP2	12	VP2	12
5	VP3	12	VP5	14	VP5	14-	VP3	14	VP15	14	VP3	14	VP3	14
6	VP3	14	VP6	14	VP6	14-	VP3	12	VP15	12	VP3	12	VP3	12
7	VP4	12	VP7	14	VP7	14-	VP4	14	VP16	14	VP4	14	VP4	14
8	VP4	14	VP8	14	VP8	14-	VP4	12	VP16	12	VP4	12	VP4	12
9	VP5	12	VP9	14	VP9	14-	VP5	14	VP17	14	VP5	14	VP5	14
10	VP5	14	VP10	14	VP10	14-	VP5	12	VP17	12	VP5	12	VP5	12
11	VP6	12	VP11	14	VP11	14-	VP6	14	VP18	14	VP6	14	VP6	14
12	VP6	14	VP12	14	VP12	14-	VP6	12	VP18	12	VP6	12	VP6	12
13	VP7	12	Com		Com+		VP7	14	VP19	14	VP7	14	VP7	14
14	VP7	14	VP1	12	VP1	12-	VP7	12	VP19	12	VP7	12	VP7	12
15	VP8	12	VP2	12	VP2	12-	VP8	14	VP20	14	VP8	14	VP8	14
16	VP8	14	VP3	12	VP3	12-	VP8	12	VP20	12	VP8	12	VP8	12
17	VP9	12	VP4	12	VP4	12-	VP9	14	VP21	14	VP9	14	VP9	14
18	VP9	14	VP5	12	VP5	12-	VP9	12	VP21	12	VP9	12	VP9	12
19	VP10	12	VP6	12	VP6	12-	VP10	14	VP22	14	VP10	14	VP10	14
20	VP10	14	VP7	12	VP7	12-	VP10	12	VP22	12	VP10	12	VP10	12
21	VP11	12	VP8	12	VP8	12-	VP11	14	VP23	14	VP11	14	VP11	14
22	VP11	14	VP9	12	VP9	12-	VP11	12	VP23	12	VP11	12	VP11	12
23	VP12	12	VP10	12	VP10	12-	VP12	14	VP24	14	VP12	14	VP12	14
24	VP12	14	VP11	12	VP11	12-	VP12	12	VP24	12	VP12	12	VP12	12
25	Com		VP12	12	VP12	12-	Com 1-12		Com 13-24		-	-	-	-

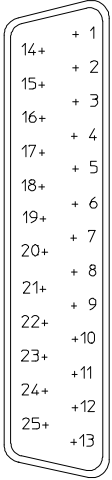

Note
The drawing shows the view onto the Sub-D plug on the valve terminal.

- VP Valve position
- 1) Sub D-A, first Sub-D plug
- 2) Sub-D B, second Sub-D plug

Example of pin allocation V12

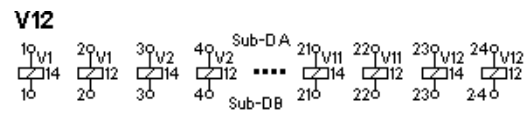



Valve terminals VTOC

Key features – Electrical components

Pin allocation – Sub-D plug, 44-pin

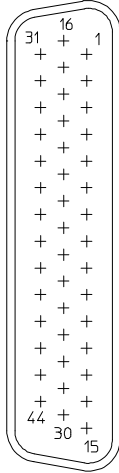
Pin	-V5		-V6				-V7				-V13	
			Sub-D A ¹⁾		Sub-D B ²⁾		Sub-D A ¹⁾		Sub-D B ²⁾			
1	VP1	14	VP1	14+	VP1	14-	VP1	14	VP1	14	VP1	12
2	VP1	12	VP1	12+	VP1	12-	VP1	12	VP1	12	VP1	14
3	VP2	14	VP2	14+	VP2	14-	VP2	14	VP2	14	VP2	12
4	VP2	12	VP2	12+	VP2	12-	VP2	12	VP2	12	VP2	14
5	VP3	14	VP3	14+	VP3	14-	VP3	14	VP3	14	VP3	12
6	VP3	12	VP3	12+	VP3	12-	VP3	12	VP3	12	VP3	14
7	VP4	14	VP4	14+	VP4	14-	VP4	14	VP4	14	VP4	12
8	VP4	12	VP4	12+	VP4	12-	VP4	12	VP4	12	VP4	14
9	VP5	14	VP5	14+	VP5	14-	VP5	14	VP5	14	VP5	12
10	VP5	12	VP5	12+	VP5	12-	VP5	12	VP5	12	VP5	14
11	VP6	14	VP6	14+	VP6	14-	VP6	14	VP6	14	VP6	12
12	VP6	12	VP6	12+	VP6	12-	VP6	12	VP6	12	VP6	14
13	VP7	14	VP7	14+	VP7	14-	VP7	14	VP7	14	VP7	12
14	VP7	12	VP7	12+	VP7	12-	VP7	12	VP7	12	VP7	14
15	VP8	14	VP8	14+	VP8	14-	VP8	14	VP8	14	VP8	12
16	VP8	12	VP8	12+	VP8	12-	VP8	12	VP8	12	VP8	14
17	VP9	14	VP9	14+	VP9	14-	VP9	14	VP9	14	VP9	12
18	VP9	12	VP9	12+	VP9	12-	VP9	12	VP9	12	VP9	14
19	VP10	14	VP10	14+	VP10	14-	VP10	14	VP10	14	VP10	12
20	VP10	12	VP10	12+	VP10	12-	VP10	12	VP10	12	VP10	14
21	VP11	14	VP11	14+	VP11	14-	VP11	14	VP11	14	VP11	12
22	VP11	12	VP11	12+	VP11	12-	VP11	12	VP11	12	VP11	14
23	VP12	14	VP12	14+	VP12	14-	VP12	14	VP12	14	VP12	12
24	VP12	12	VP12	12+	VP12	12-	VP12	12	VP12	12	VP12	14
25	VP13	14	VP13	14+	VP13	14-	VP13	14	VP13	14	VP13	12
26	VP13	12	VP13	12+	VP13	12-	VP13	12	VP13	12	VP13	14
27	VP14	14	VP14	14+	VP14	14-	VP14	14	VP14	14	VP14	12
28	VP14	12	VP14	12+	VP14	12-	VP14	12	VP14	12	VP14	14
29	VP15	14	VP15	14+	VP15	14-	VP15	14	VP15	14	VP15	12
30	VP15	12	VP15	12+	VP15	12-	VP15	12	VP15	12	VP15	14
31	VP16	14	VP16	14+	VP16	14-	VP16	14	VP16	14	VP16	12
32	VP16	12	VP16	12+	VP16	12-	VP16	12	VP16	12	VP16	14
33	VP17	14	VP17	14+	VP17	14-	VP17	14	VP17	14	VP17	12
34	VP17	12	VP17	12+	VP17	12-	VP17	12	VP17	12	VP17	14
35	VP18	14	VP18	14+	VP18	14-	VP18	14	VP18	14	VP18	12
36	VP18	12	VP18	12+	VP18	12-	VP18	12	VP18	12	VP18	14
37	VP19	14	VP19	14+	VP19	14-	VP19	14	VP19	14	VP19	12
38	VP19	12	VP19	12+	VP19	12-	VP19	12	VP19	12	VP19	14
39	VP20	14	VP20	14+	VP20	14-	VP20	14	VP20	14	VP20	12
40	VP20	12	VP20	12+	VP20	12-	VP20	12	VP20	12	VP20	14
41	VP21	14	VP21	14+	VP21	14-	VP21	14	VP21	14	Com	
42	VP21	12	VP21	12+	VP21	12-	VP21	12	VP21	12	Com	
43	Com		VP22	14+	VP22	14-	VP22	14	VP22	14	Com	
44	Com		VP22	12+	VP22	12-	VP22	12	VP22	12	Com	



 Note
The drawing shows the view onto the Sub-D plug on the valve terminal.

VP Valve position
1) Sub-D-A, first Sub-D plug
2) Sub-D-B, second Sub-D plug

Valve terminals VTOC

Key features – Electrical components



Pin allocation – Flat cable, 26-pin													
	Pin	-V8		-V14		-V15				-V17			
						Plug 1		Plug 2		Plug 1		Plug 2	
	1	VP1	14	VP1	14	VP1	14	VP13	14	VP12	14	VP24	14
	2	VP1	12	VP1	12	VP1	12	VP13	12	VP12	12	VP24	12
	3	VP2	14	VP2	14	VP2	14	VP14	14	VP11	14	VP23	14
	4	VP2	12	VP2	12	VP2	12	VP14	12	VP11	12	VP23	12
	5	VP3	14	VP3	14	VP3	14	VP15	14	VP10	14	VP22	14
	6	VP3	12	VP3	12	VP3	12	VP15	12	VP10	12	VP22	12
	7	VP4	14	VP4	14	VP4	14	VP16	14	VP9	14	VP21	14
	8	VP4	12	VP4	12	VP4	12	VP16	12	VP9	12	VP21	12
	9	VP5	14	VP5	14	VP5	14	VP17	14	VP8	14	VP20	14
	10	VP5	12	VP5	12	VP5	12	VP17	12	VP8	12	VP20	12
	11	VP6	14	VP6	14	VP6	14	VP18	14	VP7	14	VP19	14
	12	VP6	12	VP6	12	VP6	12	VP18	12	VP7	12	VP19	12
	13	VP7	14	VP7	14	VP7	14	VP19	14	VP6	14	VP18	14
	14	VP7	12	VP7	12	VP7	12	VP19	12	VP6	12	VP18	12
	15	VP8	14	VP8	14	VP8	14	VP20	14	VP5	14	VP17	14
	16	VP8	12	VP8	12	VP8	12	VP20	12	VP5	12	VP17	12
	17	VP9	14	VP9	14	VP9	14	VP21	14	VP4	14	VP16	14
	18	VP9	12	VP9	12	VP9	12	VP21	12	VP4	12	VP16	12
	19	VP10	14	VP10	14	VP10	14	VP22	14	VP3	14	VP15	14
	20	VP10	14	VP10	14	VP10	14	VP22	12	VP3	12	VP15	12
	21	VP11	14	VP11	14	VP11	14	VP23	14	VP2	14	VP14	14
	22	VP11	12	VP11	12	VP11	12	VP23	12	VP2	12	VP14	12
	23	VP12	14	VP12	14	VP12	14	VP24	14	VP1	14	VP13	14
	24	VP12	12	VP12	12	VP12	12	VP24	12	VP1	12	VP13	12
25	Com		Com		Com		Com		Com		Com		
26	Com		Com		Com		Com		Com		Com		

VP Valve position

Valve terminals VTOC

Key features – Electrical components



Pin allocation – Flat cable, 40-pin

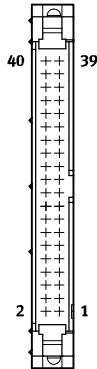

Pin	-V9		-V18			
			Plug 1		Plug 2	
1	VP10	12+	VP10	12+	VP11	14+
2	VP10	12-	VP10	12-	VP11	14-
3	VP10	14+	VP10	14+	VP11	12+
4	VP10	14-	VP10	14-	VP11	12-
5	VP9	12+	VP9	12+	VP12	14+
6	VP9	12-	VP9	12-	VP12	14-
7	VP9	14+	VP9	14+	VP12	12+
8	VP9	14-	VP9	14-	VP12	12-
9	VP8	12+	VP8	12+	VP13	14+
10	VP8	12-	VP8	12-	VP13	14-
11	VP8	14+	VP8	14+	VP13	12+
12	VP8	14-	VP8	14-	VP13	12-
13	VP7	12+	VP7	12+	VP14	14+
14	VP7	12-	VP7	12-	VP14	14-
15	VP7	14+	VP7	14+	VP14	12+
16	VP7	14-	VP7	14-	VP14	12-
17	VP6	12+	VP6	12+	VP15	14+
18	VP6	12-	VP6	12-	VP15	14-
19	VP6	14+	VP6	14+	VP15	12+
20	VP6	14-	VP6	14-	VP15	12-
21	VP5	12+	VP5	12+	VP16	14+
22	VP5	12-	VP5	12-	VP16	14-
23	VP5	14+	VP5	14+	VP16	12+
24	VP5	14-	VP5	14-	VP16	12-
25	VP4	12+	VP4	12+	VP17	14+
26	VP4	12-	VP4	12-	VP17	14-
27	VP4	14+	VP4	14+	VP17	12+
28	VP4	14-	VP4	14-	VP17	12-
29	VP3	12+	VP3	12+	VP18	14+
30	VP3	12-	VP3	12-	VP18	14-
31	VP3	14+	VP3	14+	VP18	12+
32	VP3	14-	VP3	14-	VP18	12-
33	VP2	12+	VP2	12+	VP19	14+
34	VP2	12-	VP2	12-	VP19	14-
35	VP2	14+	VP2	14+	VP19	12+
36	VP2	14-	VP2	14-	VP19	12-
37	VP1	12+	VP1	12+	VP20	14+
38	VP1	12-	VP1	12-	VP20	14-
39	VP1	14+	VP1	14+	VP20	12+
40	VP1	14-	VP1	14-	VP20	12-

Note

The drawing shows the view onto the flat cable plug on the valve terminal.

VP Valve position

Example of pin allocation V18

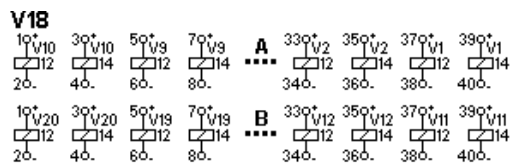

Valve terminals VTOC

Key features – Electrical components

I-Port interface with interlock/IO-Link			
IO-Link	I-Port	Interlock	
<p>IO-Link is an interface that supplies data for communication in addition to the power supply.</p> <p>An IO-Link system consists of an IO-Link master and IO-Link devices. The IO-Link master offers the interface to the higher-order controller (PLC) and controls communication with the connected IO-Link devices. One device with IO-Link (e.g. an IO-Link valve terminal from Festo) can be connected to each port on an IO-Link master.</p>	<p>The Festo-specific I-Port interface based on IO-Link offers the following connection options:</p> <ul style="list-style-type: none"> • Directly at the fieldbus, by mounting a fieldbus node CTEU • Connection to a higher-order I-Port master from Festo 	<p>The interlock function enables the first 16 solenoid coils to be individually supplied externally. This guarantees safety-related release of these valves.</p> <p>The interlock interface is established via external contacts for a single-pin connection or via safety output terminals for a double-pin connection.</p>	<p>For applications that do not require actuation of the solenoid coils via interlock, the Sub-D connection can be bypassed using a special Sub-D socket (NEFF...).</p> <p>The solenoid coils are then supplied with load voltage via the I-Port interface.</p>

Overview

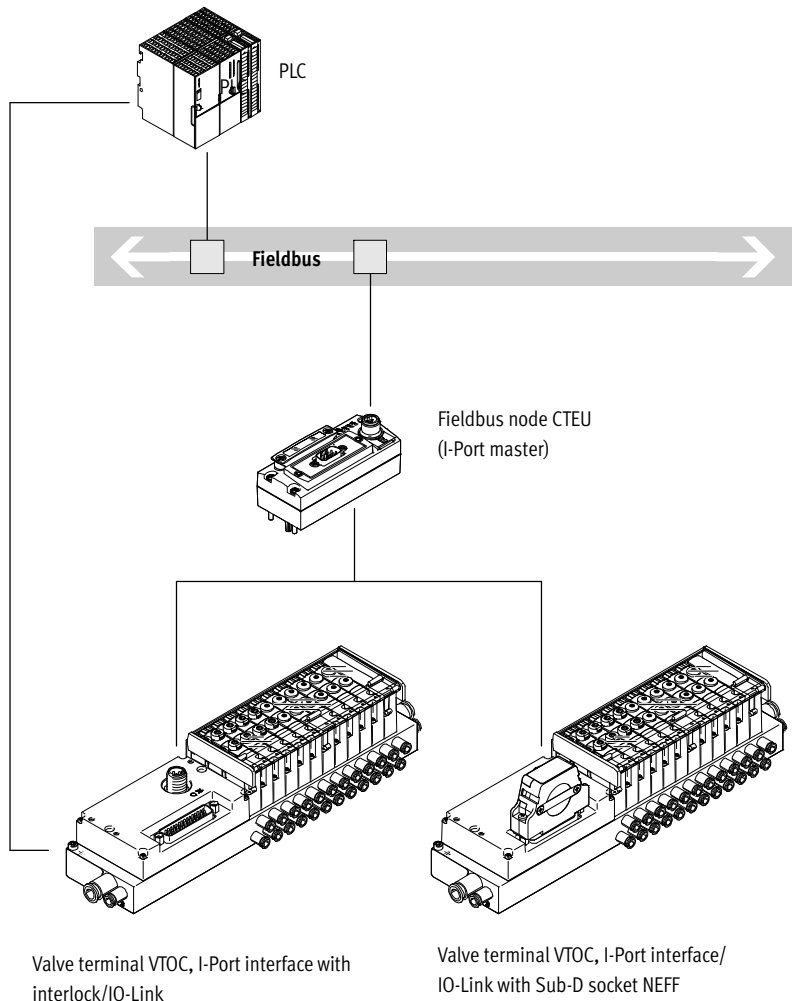

Valve terminal VTOC, I-Port interface with interlock/IO-Link

Valve terminal VTOC, I-Port interface/IO-Link with Sub-D socket NEFF

Valve terminals VTOC

Key features – Electrical components

Interlock interface

Single-pin interlock interface

- The interlock interface is established via external positive switching contacts or single-pin switching safety terminals
- 16 solenoid coils can be actuated via the interlock (Vn+)
- Solenoid coils that do not require interlock actuation can be supplied directly with 24 V from pins 1 ... 3
- Application of the respective input voltage is reported via the fieldbus as an image table

Double-pin interlock interface

- The interlock interface is established via external positive-negative switching safety terminals
- The solenoid coils of the interlock valves are actuated via the corresponding pins in the sub-D plug (pins 7 ... 38)
- Solenoid coils that do not require interlock actuation can be supplied directly with 24 V (e.g. from pins 1 ... 3)
- Any difference in potential between Vn- and 0 VVAL/OUT must be below 5 V

Sample circuit diagram for a single-pin interlock interface

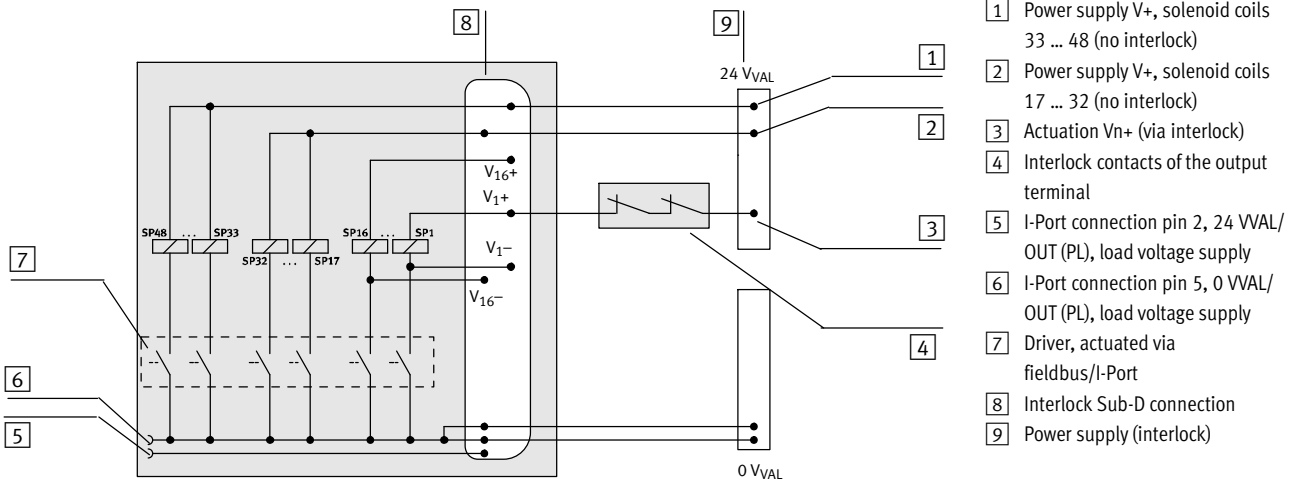

Sample circuit diagram for a double-pin interlock interface

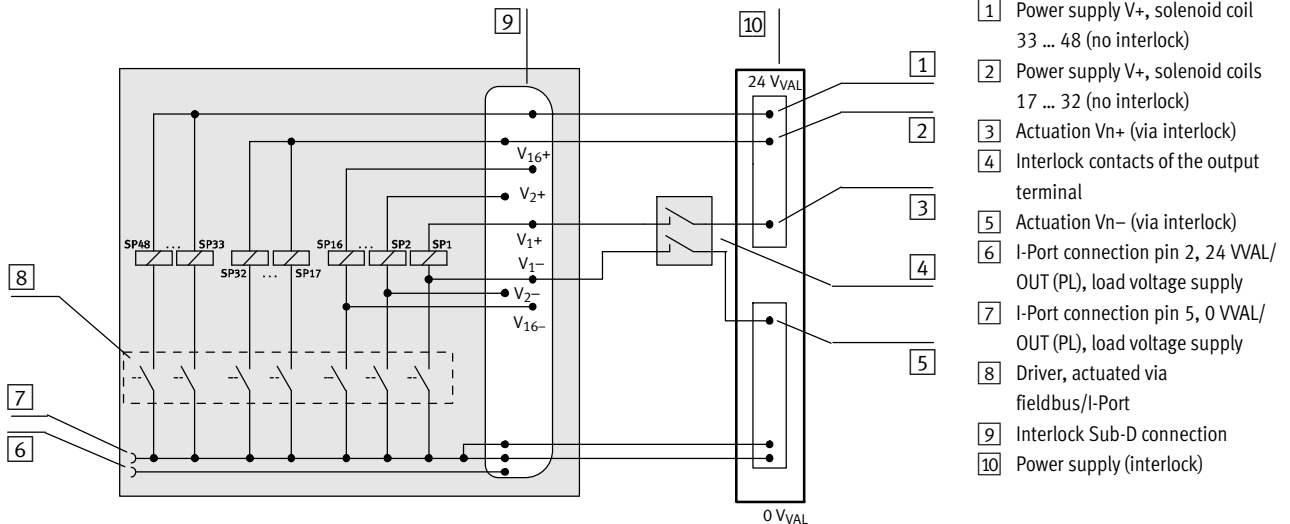

Valve terminals VTOC

Key features – Electrical components





Pin allocation – Interlock									
	Pin	Coil	Signal	Pin	Coil	Signal	Pin	Coil	Signal
	1	–	24 V _{VAL/OUT}	16	5	V5-	31	13	V13+
	2	–	24 V _{VAL/OUT}	17	6	V6+	32	13	V13-
	3	–	24 V _{VAL/OUT}	18	6	V6-	33	14	V14+
	4	1 ... 48	0 V _{VAL/OUT}	19	7	V7+	34	14	V14-
	5	1 ... 48	0 V _{VAL/OUT}	20	7	V7-	35	15	V15+
	6	1 ... 48	0 V _{VAL/OUT}	21	8	V8+	36	15	V15-
	7	1	V1+	22	8	V8-	37	16	V16+
	8	1	V1-	23	9	V9+	38	16	V16-
	9	2	V2+	24	9	V9-	39	17 ... 32	V17...32+
	10	2	V2-	25	10	V10+	40	33 ... 48	V33...48+
	11	3	V3+	26	10	V10-	41	1 ... 48	0 V _{VAL/OUT}
	12	3	V3-	27	11	V11+	42	1 ... 48	0 V _{VAL/OUT}
	13	4	V4+	28	11	V11-	43	1 ... 48	0 V _{VAL/OUT}
	14	4	V4-	29	12	V12+	44	–	n.c.
	15	5	V5+	30	12	V12-	Housing		FE

Pin allocation – I-Port interface/IO-Link			
	Pin	Allocation	Function
	1	24V _{EL/SEN} (PS)	Operating voltage supply (electronics, sensors/inputs)
	2	24V _{VAL/OUT} (PL)	Load voltage supply (valves/outputs)
	3	0V _{EL/SEN} (PS)	Operating voltage supply (electronics, sensors/inputs)
	4	C/Q	Data communication
	5	0V _{VAL/OUT} (PL)	Load voltage supply (valves/outputs)
	Housing, FE		Functional earth

Valve terminals VTOC

FESTO

Technical data – Valve terminal VTOC with multi-pin plug connection

-  Voltage
24 V DC
-  Pressure
0 ... +8 bar
-  Temperature range
-5 ... +50 °C

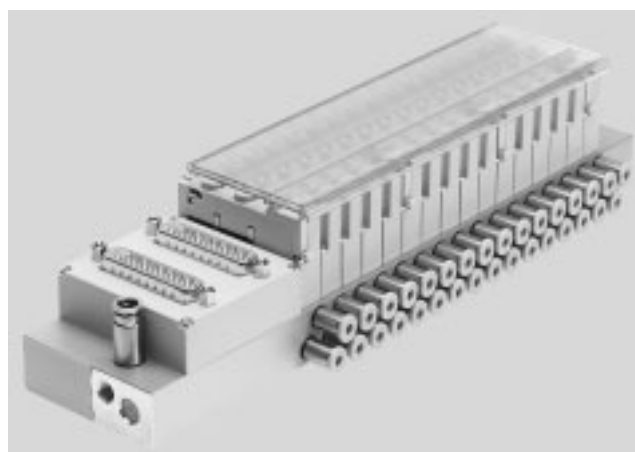

General technical data			
Valve function			2x3/2-way valve, closed, single solenoid
Design			Poppet valve with spring return
Sealing principle			Soft
Actuation type			Electric
Reset method			Mechanical spring
Type of control			Direct
Direction of flow			Non-reversible
Exhaust function			No flow control
Manual override			Non-detenting, detenting and non-detenting, detenting (without accessories)
Type of mounting			Via through-hole or thread
Width	[mm]		10
Nominal size	[mm]		0.65
Max. number of valve positions			24
Standard nominal flow rate	q _{nN}	[l/min]	10

Operating and environmental conditions			
Operating medium			Compressed air according to ISO 8573-1:2010 [7:4:4]
Note on operating/pilot medium			Lubricated operation possible (in which case lubricated operation will always be required)
Operating pressure	[bar]		0 ... +8
Ambient temperature	[°C]		-5 ... +50
Temperature of medium	[°C]		-5 ... +50
Note on materials			RoHS-compliant
CE marking (see declaration of conformity)			To EU EMC Directive
Certification			cULus recognized (OL)

Valve terminals VTOC

Technical data – Valve terminal VTOC with multi-pin plug connection

Product weight		
Valve	[g]	30
Blanking plate for vacant position	[g]	20



Electrical data		
Electrical actuation		Multi-pin plug (Sub-D/flat cable)
Nominal operating voltage	[V DC]	24
Permissible voltage fluctuations	[%]	±10
Protection class to EN 60529		IP40
Duty cycle	[%]	100

Valve switching times		
On	[ms]	4.7
Off	[ms]	5.2

Safety characteristics	
Note on forced checking procedure	Min. 1/week
Resistance to shocks	Shock test at severity level 2, to FN 942017-5 and EN 60068-2-27
Vibration resistance	Transport application test at severity level 2, to FN942017-4 and EN 60068-2-6

Valve terminals VTOC

Technical data – Valve terminal VTOC with I-Port interface, interlock/IO-Link

-  Voltage
24 V DC
-  Pressure
0 ... +8 bar
-  Temperature range
-5 ... +50 °C

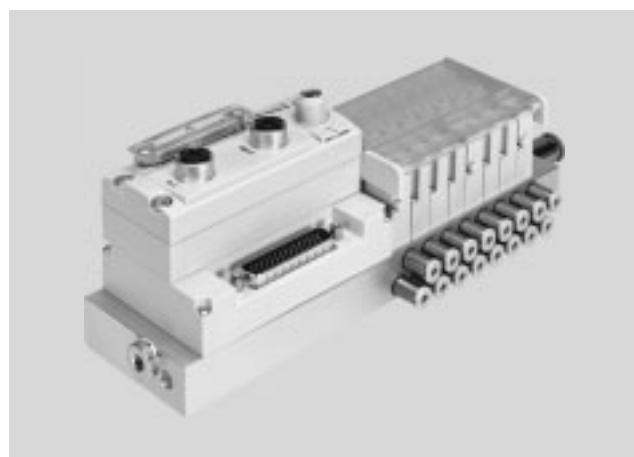

General technical data			
Valve	2x3/2 normally closed, reset via mechanical spring		
Design	Poppet valve with spring return		
Reset method	Mechanical spring		
Type of control	Direct		
Direction of flow	Non-reversible		
Exhaust function	No flow control		
Manual override	Non-detenting, detenting and non-detenting, detenting (without accessories)		
Communication types	I-Port/IO-Link		
Number of valve positions	2 ... 24		
Max. number of solenoid coils	48		
Number of interlock solenoid coils	16		
Number of inputs for reading back voltage	18 (16x interlock + 2 group supply)		
Mounting position	Any		
Nominal flow rate	[l/min]	10	
Residual ripple	[V _{SS}]	4	
Baud rate	COM3	[kbps]	230.4
	COM2	[kbps]	38.4
IO-Link	Protocol	V1.0	
	Connection technology	M12, A-coded	
	Port type	Type B	
	Number of ports	1	
	Process data width OUT	6 bytes	
	Process data IN	4 bytes	
	Minimum cycle time	11.5 ms (2.3 ms per frame = 2 bytes of user data)	
Product weight	Valve	[g]	30
	Blanking plate for vacant position	[g]	20

Operating and environmental conditions			
Operating medium	Compressed air according to ISO 8573-1:2010 [7:4:4]		
Note on operating/pilot medium	Lubricated operation possible (in which case lubricated operation will always be required)		
Operating pressure	[bar]	0 ... +8	
Ambient temperature	[°C]	-5 ... +50	
Note on materials	RoHS-compliant		
CE marking (see declaration of conformity)	To EU EMC Directive		
Certification	cULus recognized (OL)		

Valve switching times			
On	[ms]	4.7	
Off	[ms]	5.2	

Valve terminals VTOC

Technical data – Valve terminal VTOC with I-Port interface, interlock/IO-Link

Electrical data			
Power supply	Interlock load voltage (valves)	[V DC]	24 (±10%)
	Load voltage (valves)	[V DC]	24 (±10%)
	Operating voltage (electronics)	[V DC]	24 (±25%)
Power consumption (load) per solenoid coil at nominal operating voltage		[W]	1/0.4 (after 30 ms)
Intrinsic current consumption via I-Port (valves/electronics)		[mA]	40/30
Protection class to EN 60529			IP40

Safety characteristics	
Reliable component	Yes
Note on forced checking procedure	Min. 1/week
Resistance to shocks	Shock test at severity level 2, to FN 942017-5 and EN 60068-2-27
Vibration resistance	Transport application test at severity level 2, to FN942017-4 and EN 60068-2-6

Valve terminals VTOC

Technical data – Valve terminal VTOC

Dimensions – Sub-D, single or double

Download CAD data → www.festo.com

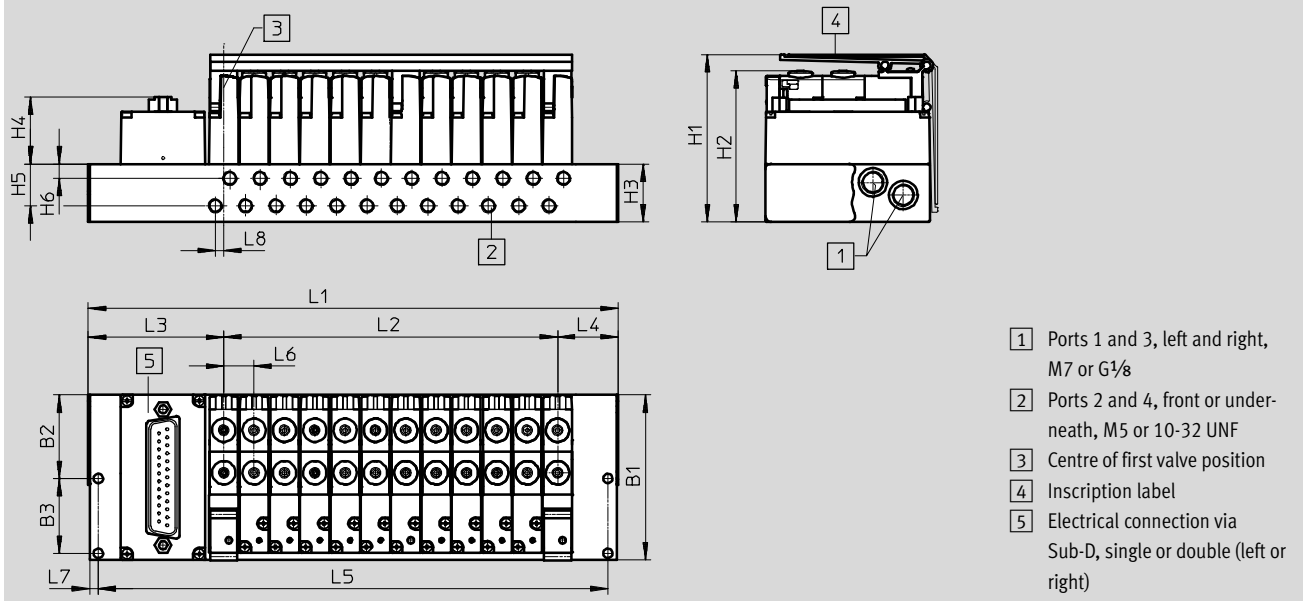

- 1 Ports 1 and 3, left and right, M7 or G $\frac{1}{8}$
- 2 Ports 2 and 4, front or underneath, M5 or 10-32 UNF
- 3 Centre of first valve position
- 4 Inscription label
- 5 Electrical connection via Sub-D, single or double (left or right)

	Comment	Electrical connection on top, single			Electrical connection on top, double		
Pneumatic connection	–	M7	G $\frac{1}{8}$	G $\frac{1}{8}$	M7	G $\frac{1}{8}$	G $\frac{1}{8}$
Through-hole	–	∅ 3.3	∅ 3.3	M4	∅ 3.3	∅ 3.3	M4
L1	–	L2+L3+L4	L2+L3+L4	L2+L3+L4	L2+L3+L4	L2+L3+L4	L2+L3+L4
L2	–	(n-1)x10.5	(n-1)x10.5	(n-1)x10.5	(n-1)x10.5	(n-1)x10.5	(n-1)x10.5
L3	Distance from centre of first valve position to outer edge on left-hand side	41.4	46.4	36.9	66.4	71.4	66.4
	Sub-D connection, 44-pin, top right, 1-way: Distance from centre of first valve position to outer edge on left-hand side	14.4	20.4	20.4	–	–	–
L4	Distance from centre of last valve position to outer edge on right-hand side	14.4	20.4	20.4	–	–	–
	Sub-D connection, 44-pin, top right, 1-way: Distance from centre of last valve position to outer edge on right-hand side	41.4	46.4	36.9	–	–	–
L5	–	(L1-6)	(L1-6)	(L1-6)	(L1-6)	(L1-6)	(L1-6)

B1	B2	B3	H1	H2	H3	H4	H5	H6	L6	L7	L8
	±0.1	±0.1								±0.1	
57	28.9	25.9	57.9	52.3	20	23.1	14.5	5	10.5	3	2.9

Valve terminals VTOC

Technical data – Valve terminal VTOC

Dimensions – Flat cable on top

Download CAD data → www.festo.com

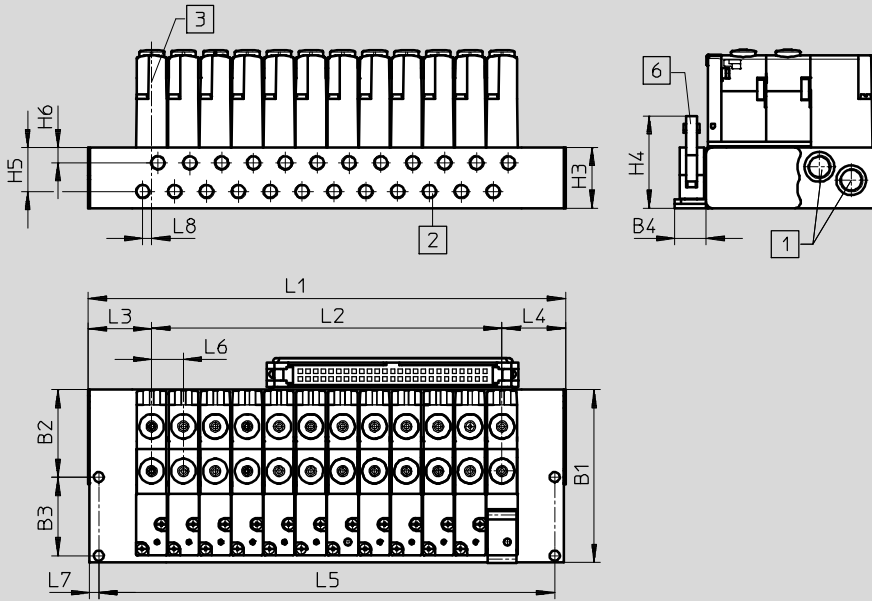

- 1 Ports 1 and 3, left and right, M7 or G $\frac{1}{8}$
- 2 Ports 2 and 4, front or underneath, M5 or 10-32 UNF
- 3 Centre of first valve position
- 6 Electrical connection via flat cable

	Comment	Electrical connection via flat cable on top		
Pneumatic connection	–	M7	G $\frac{1}{8}$	G $\frac{1}{8}$
Through-hole	–	∅ 3.3	∅ 3.3	M4
L1	–	L2+L3+L4	L2+L3+L4	L2+L3+L4
L2	–	(n-1)×10.5	(n-1)×10.5	(n-1)×10.5
L3	Distance from centre of first valve position to outer edge on left-hand side	14.4	46.4	36.9
L4	Distance from centre of last valve position to outer edge on right-hand side	14.4	20.4	20.4
L5	–	(L1-6)	(L1-6)	(L1-6)

B1	B2	B3	B4	H3	H4	H5	H6	L6	L7	L8
57	±0.1	±0.1	10.4	20	30.5	14.5	5	10.5	±0.1	2.9

Valve terminals VTOC

Technical data – Valve terminal VTOC

Dimensions – Flat cable underneath

Download CAD data → www.festo.com

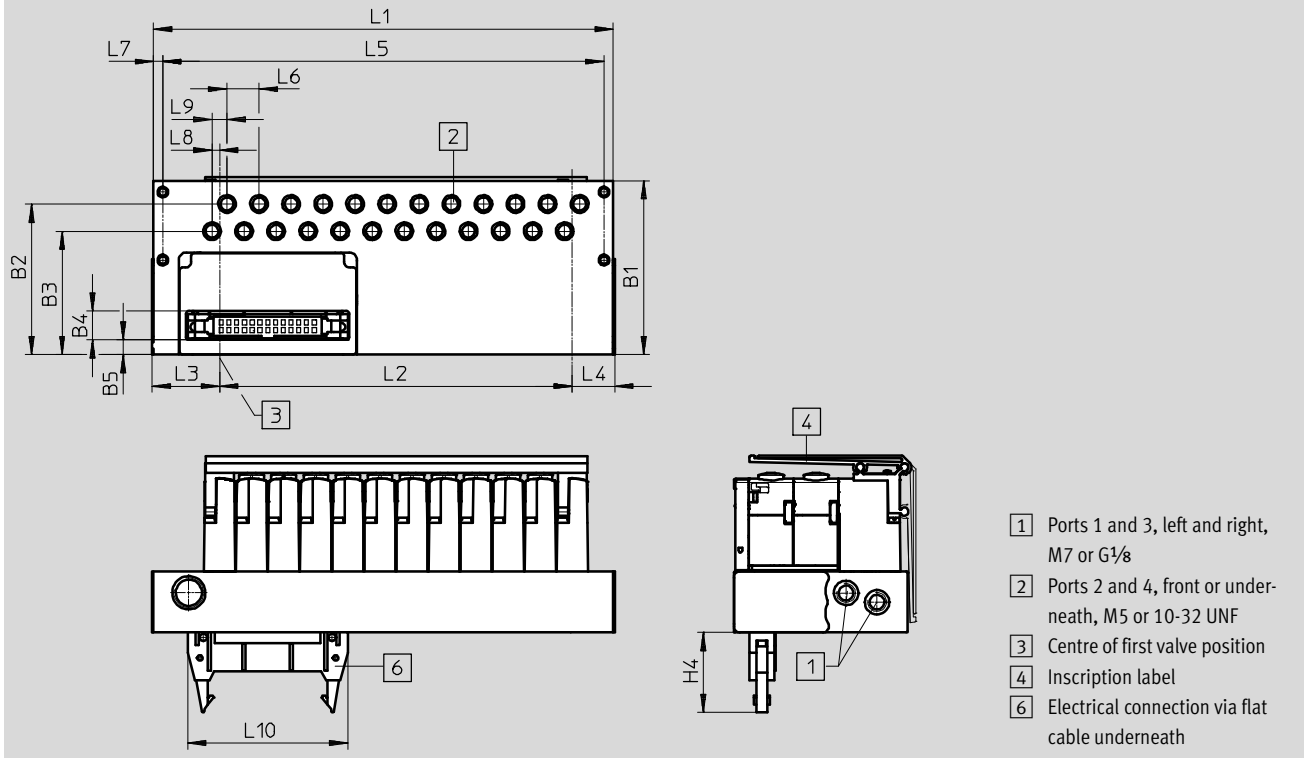

	Comment	Electrical connection via flat cable underneath				
Pneumatic connection	–	M7 left	M7 front	G $\frac{1}{8}$ front	G $\frac{1}{8}$ left	G $\frac{1}{8}$ left
Through-hole	–	Ø 3.3	Ø 3.3	Ø 3.3	Ø 3.3	M4
L1	–	L2+L3+L4	L2+L3+L4	L2+L3+L4		
L2	–	(n-1)x10.5	(n-1)x10.5	(n-1)x10.5		
L3	Distance from centre of first valve position to outer edge on left-hand side	14.4	25.55	21.6	20.4	20.4
L4	Distance from centre of last valve position to outer edge on right-hand side	14.4	28.55	20.4	20.4	20.4
L5	–	(L1-6)	(L1-6)	(L1-6)	(L1-6)	(L1-6)

B1	B2	B3	B4	H3	H4	H5	H6	L6	L7	L8	L9	L10
	±0.1	±0.1							±0.1			
57	28.9	25.9	10.4	20	30.5	14.5	5	10.5	3	2.5	4.9	52.5

Valve terminals VTOC

Technical data – Valve terminal VTOC



Dimensions – I-Port interface with interlock

Download CAD data → www.festo.com

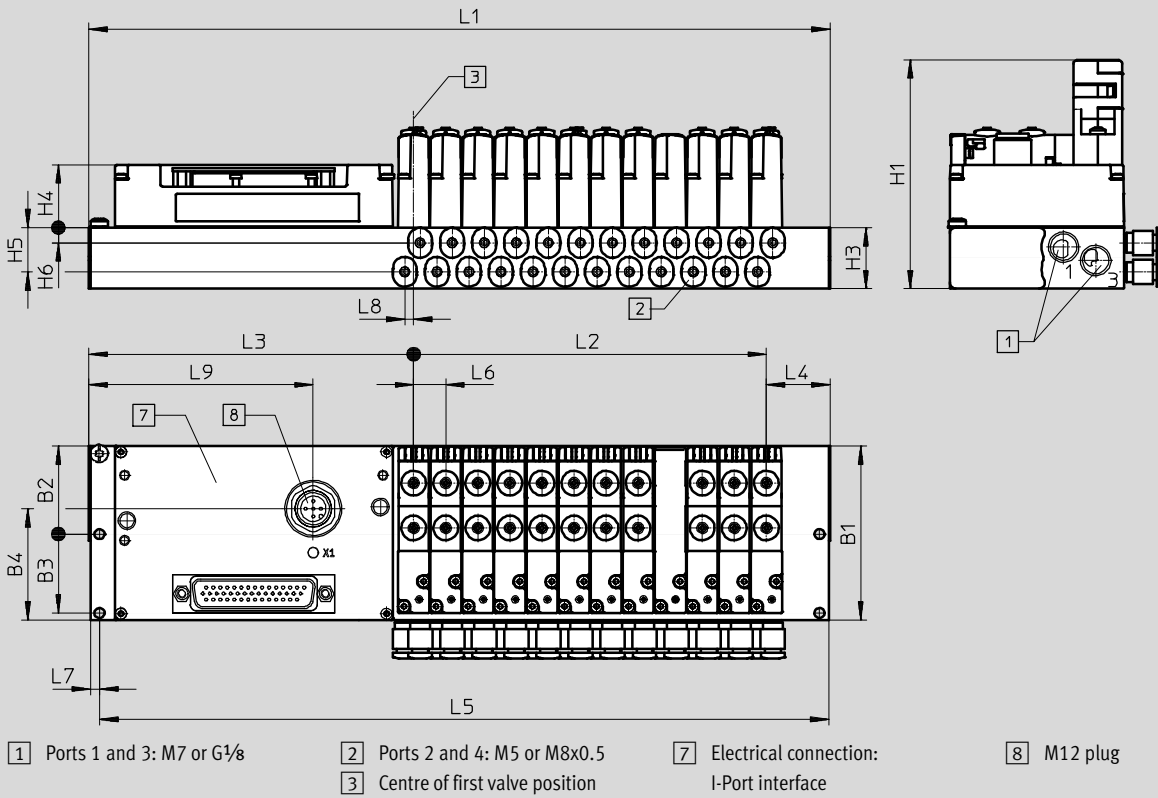

B1	B2	B3	B4	H1	H2	H3	H4	H5	H6	L1	L2	L3	L4	L5	L6	L7	L8	L9	
57	±0.1	±0.1	36.4	74.7	54.7	20	20.6	±0.1	±0.1	L2+L3+L4	(n-1)x10.5	105.9	14.4	(L1-6)	±0.2	±0.5	±0.1	2.9	73

Note
 Deviating dimensions following assembly of the fieldbus node CTEU. Specified dimensions for the fieldbus node CTEU → installation system CTEU/CTEL

Valve terminals VTOC

Technical data – Valve terminal VTOC

Dimensions – I-Port interface with Sub-D socket NEFF

Download CAD data → www.festo.com

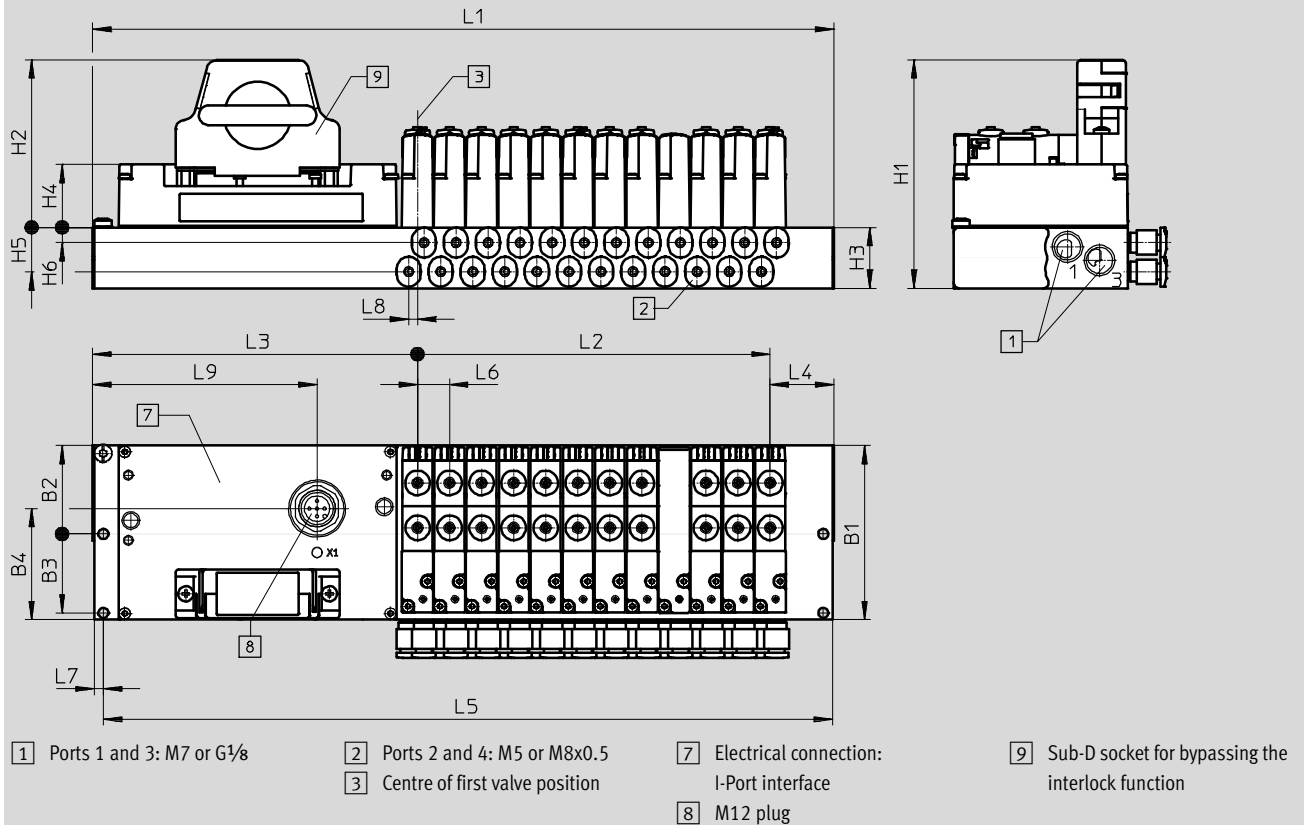

B1	B2	B3	B4	H1	H2	H3	H4	H5	H6	L1	L2	L3	L4	L5	L6	L7	L8	L9	
57	±0.1	±0.1		74.7	54.7	20	20.6	±0.1	±0.1	L2+L3+L4	(n-1)x10.5	105.9	14.4	(L1-6)	±0.2	±0.5	±0.1	2.9	73

 Note
 Deviating dimensions following assembly of the fieldbus node CTEU. Specified dimensions for the fieldbus node CTEU → installation system CTEU/CTEL

Valve terminals VTOC

Technical data – Valve terminal VTOC

FESTO

Dimensions – Pneumatic connections

Download CAD data → www.festo.com

Ports 2 and 4 underneath, M5 (10-32 UNF)

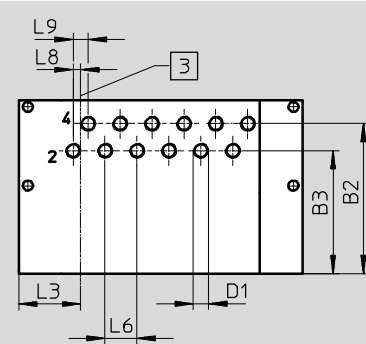

3 Centre of first valve position

Ports 2 and 4 underneath, compact

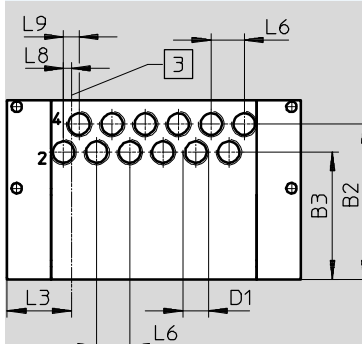

3 Centre of first valve position

Ports 2 and 4 at front, M5 (10-32 UNF)

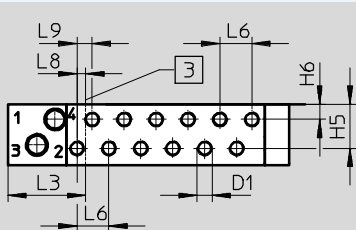

3 Centre of first valve position

Ports 2 and 4 at front, compact

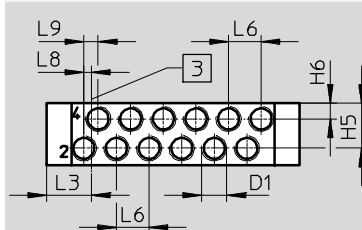

3 Centre of first valve position

Port	B2	B3 ±0.1	D1	H5	H6	L6	L8	L9
Underneath, M5 (10-32 UNF)	49.3	40.4	M5	–	–	10.5	2.5	4.9
Underneath, compact	49.3	40.4	M8x0.5	–	–	10.5	2.5	4.9
Front, M5 (10-32 UNF)	–	–	M5	14.5	5	10.5	2.9	5
Front, compact	–	–	M8x0.5	14.5	5	10.5	2.5	4.6

Ports 1 and 3, M7 left

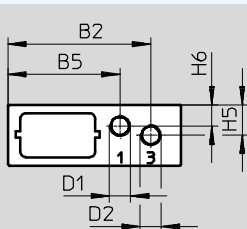

Ports 1 and 3, G1/8 left

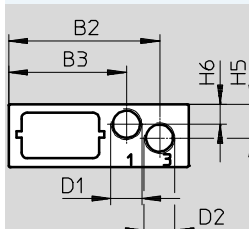

Ports 1 and 3, G1/8 left with mounting hole M4

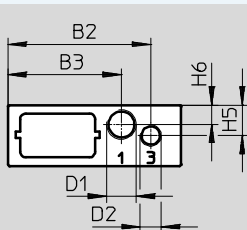

Ports 1 and 3	B2	B3	D1	D2	H5	H6
M7 left	47	36.8	M7	M7	10	7
G1/8 left, with mounting hole M4	47	37.3	G1/8	M7	10	6.4

Valve terminals VTOC

Technical data – Valve terminal VTOC

Dimensions – Mounting hole

Download CAD data → www.festo.com

∅ 3.3 underneath, ports 1 and 3, M7

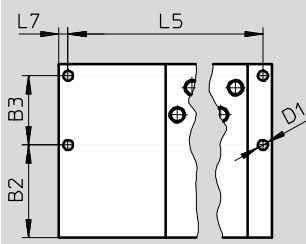

∅ 3.3 underneath, ports 1 and 3, G1/8

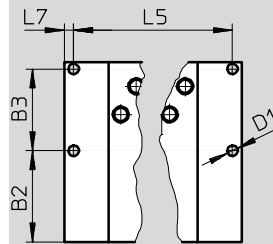

M3 underneath, ports 1 and 3, M7

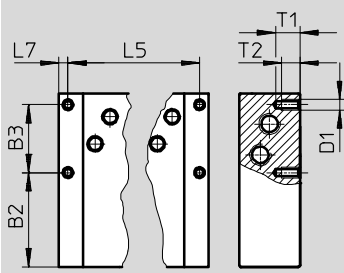

M3 underneath, ports 1 and 3, G1/8

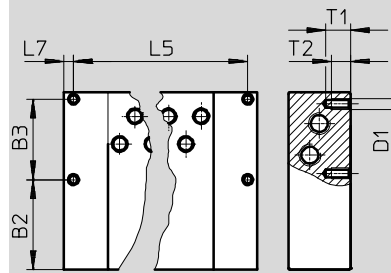

M4 underneath, ports 1 and 3, M7

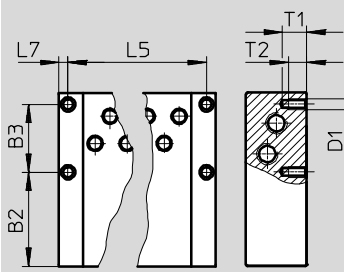

M4 or 8-32UNC underneath, ports 1 and 3, G1/8

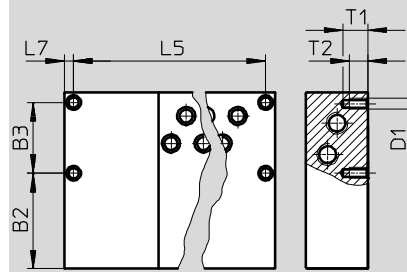

8-32UNC underneath, ports 1 and 3, M7

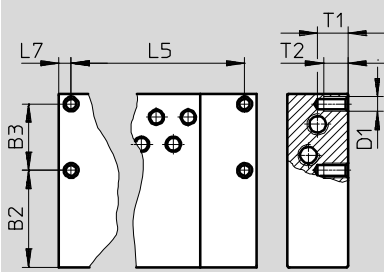

8-32UNC underneath, ports 1 and 3, G1/8

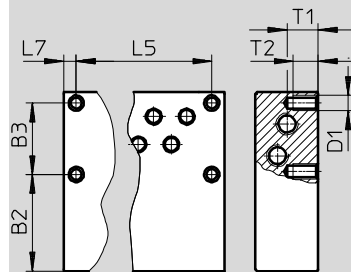

10-32UNF-2B underneath, ports 1 and 3, M7 or G1/8

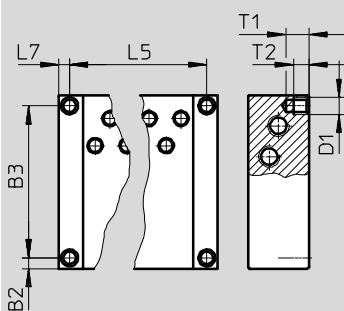

Valve terminals VTOC



Technical data – Valve terminal VTOC

	B2	B3	D1	L5	L7	T1	T2
3.3 underneath, ports 1 and 3 M7	30.5	22.8	3.3	L1-2xL7	3	–	–
3.3 underneath, ports 1 and 3 G $\frac{1}{8}$	28.9	25.9	3.3		3	–	–
M3 underneath, ports 1 and 3 M7	31	22.3	M3		3	8	6
M3 underneath, ports 1 and 3 G $\frac{1}{8}$	28.9	25.9	M3		3	8	6
M4 underneath, ports 1 and 3 M7	31	22.3	M4		3	7.5	6
M4 or 8-32UNC underneath, ports 1 and 3 G $\frac{1}{8}$	30.8	22.8	M4/8-32UNC		3	7.5	6
8-32UNC underneath, ports 1 and 3 M7	31.8	21.8	8-32UNC		4	10	8
8-32UNC underneath, ports 1 and 3 G $\frac{1}{8}$	30.8	22.8	8-32UNC		4	10	8
10-32UNF-28 underneath, ports 1 and 3, M7 or G $\frac{1}{8}$	3.5	50	10-32UNF-28		3.5	7.5	5

Valve terminals VTOC

Accessories

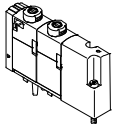
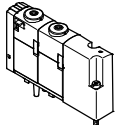
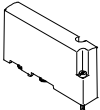
FESTO

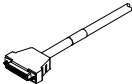
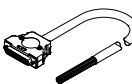



Ordering data				
	Code	Valve function	Part No.	Type
Solenoid valves				
	K	2x3/2-way valve, single solenoid, normally closed, detenting, non-detenting/detenting manual override	565450	VOVC-BT-T32C-MT-F-1T1
	K	2x3/2-way valve, single solenoid, normally closed, non-detenting manual override	565449	VOVC-BT-T32C-MH-F-1T1
Blanking plate				
	L	Blanking plate for vacant position	565451	VABB-L2-P3
Cover for manual override				
	-	Detenting, without accessories	8002234	VAMC-L1-CD
Blanking plug				
	-	For sealing the air supply or exhaust port	3568	B-1/8
	-		174309	B-M7
Connecting cable for multi-pin plug				
	-	<ul style="list-style-type: none"> • Socket Sub-D, 25-pin, IP40 • Open cable end, 15-wire 	2.5	530049 KMP6-25P-12-2,5
			5	530050 KMP6-25P-12-5
			10	530051 KMP6-25P-12-10
	-	<ul style="list-style-type: none"> • Socket, Sub-D 25-pin, IP40 • Open cable end 25-wire 	2.5	530046 KMP6-25P-20-2,5
			5	530047 KMP6-25P-20-5
			10	530048 KMP6-25P-20-10
	-	<ul style="list-style-type: none"> • Socket Sub-D, straight, 44-pin, up to 35 coils, IP40 • Open cable end, 44-wire 	2.5	575113 NEBV-S1G44-K-2.5-N-LE44-S6
			5	575114 NEBV-S1G44-K-5-N-LE44-S6
			10	575115 NEBV-S1G44-K-10-N-LE44-S6

Valve terminals VTOC

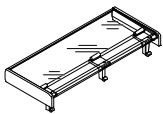
Accessories

FESTO

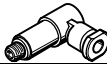
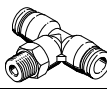





Ordering data					
	Code	Valve function		Part No.	Type
Inscription label holder					
	-	Inscription label holder for identifying the valves	3 valve positions	565571	ASCF-H-L2-3V
			4 valve positions	565572	ASCF-H-L2-4V
			5 valve positions	565573	ASCF-H-L2-5V
			6 valve positions	565574	ASCF-H-L2-6V
			7 valve positions	565575	ASCF-H-L2-7V
			8 valve positions	565576	ASCF-H-L2-8V
			9 valve positions	565577	ASCF-H-L2-9V
			10 valve positions	565578	ASCF-H-L2-10V
			11 valve positions	565579	ASCF-H-L2-11V
			12 valve positions	565580	ASCF-H-L2-12V
			13 valve positions	565581	ASCF-H-L2-13V
			14 valve positions	565582	ASCF-H-L2-14V
			15 valve positions	565583	ASCF-H-L2-15V
			16 valve positions	565584	ASCF-H-L2-16V
			17 valve positions	565585	ASCF-H-L2-17V
			18 valve positions	565586	ASCF-H-L2-18V
			19 valve positions	565587	ASCF-H-L2-19V
20 valve positions	565588	ASCF-H-L2-20V			
21 valve positions	565589	ASCF-H-L2-21V			
22 valve positions	565590	ASCF-H-L2-22V			
23 valve positions	565591	ASCF-H-L2-23V			
24 valve positions	565592	ASCF-H-L2-24V			

Ordering data						
	Code	Description	Tubing O.D.	Packaging unit quantity	Part No.	Type
Push-in fittings Technical data → Internet: quick star						
	-	QS push-in fitting	1/4"	1	183741	QS-1/8-1/4-I-U-M
			3/8"	10	567773	QB-1/8-3/8-U
			8 mm	10	153015	QS-1/8-8-I
			6 mm	10	153321	QSM-M7-6-I
			1/4"	1	183740	QSM-M7-1/4-I-U-M
			1/8"	10	183749	QSM-M5-1/8-I-U-M
			5/32"	1	130593	QSM-M5-5/32-I-U-M
			3 mm	10	153313	QSM-M5-3-I
			4 mm	10	153315	QSM-M5-4-I
	-	Push-in L-fitting	8 mm	20	130928	QSL-B-1/8-8-20
			3/16"	1	533234	QBL-1/8-3/16-U-M
			1/4"	1	533235	QBL-1/8-1/4-U-M
			3/8"	1	562578	QBL-1/8-3/8-U-M
			3 mm	10	130830	QSMLV-M5-3-I
			4 mm	10	130831	QSMLV-M5-4-I
	-	Push-in L-fitting, long	3 mm	10	130834	QSMLLV-M5-3-I
			4 mm	10	130835	QSMLLV-M5-4-I
	-	T-fitting	1/4"	1	533254	QBT-1/8-1/4-U-M
			3/8"	1	562579	QBT-1/8-3/8-U-M
			8 mm	20	130940	QST-B-1/8-8-20
Silencer Technical data → Internet: quick star						
	U	Silencer	-	1	161418	UC-M7
				50	534218	UC-M7-50

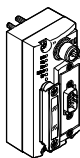
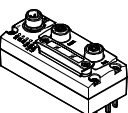
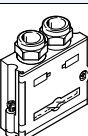
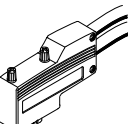
Valve terminals VTOC

Accessories



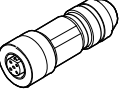
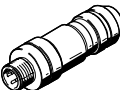
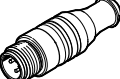
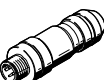



FESTO

Ordering data – CTEU			Part No.	Type
Bus node				
	–	CANopen fieldbus node	570038	CTEU-CO
	–	DeviceNet fieldbus node	570039	CTEU-DN
	–	CC-Link fieldbus node	1544198	CTEU-CC
	–	PROFIBUS fieldbus node	570040	CTEU-PB
	–	EtherCAT fieldbus node	572556	CTEU-EC
Bus connection				
	–	Sub-D plug, straight, for DeviceNet/CANopen	532219	FBS-SUB-9-BU-2x5POL-B
	–	Sub-D plug, straight, for CC-Link	532220	FBS-SUB-9-GS-2x4POL-B
	–	Sub-D plug, straight, for PROFIBUS	532216	FFBS-SUB-9-GS-DP-B
	–	Sub-D plug, angled, for CANopen, 9-pin	533783	FBS-SUB-9-WS-CO-K
	–	Sub-D plug, angled, for PROFIBUS, 9-pin	533780	FBS-SUB-9-WS-PB-K
	–	M12x1, 5-pin, A-coded, for DeviceNet/CANopen	525632	FBA-2-M12-5POL
	–	M12x1, 5-pin, B-coded, for PROFIBUS	533118	FBA-2-M12-5POL-RK
	–	For 5-pin terminal strip for DeviceNet/CANopen	525634	FBA-1-SL-5POL
	–	Terminal strip, 5-pin, for DeviceNet/CANopen	525635	FBSD-KL-2x5POL
	–	Screw terminal for CC-Link	197962	FBA-1-KL-5POL
	–	Fieldbus socket, M12x1, 5-pin, for DeviceNet/CANopen	18324	FBSD-GD-9-5POL
	–	Plug, M12x1, 5-pin, for DeviceNet/CANopen		FBS-M12-5GS-PG9
	–	Straight socket, M12x1, 5-pin, for assembling a connecting cable compatible with FBA-2-M12-5POL-RK for PROFIBUS	1067905	NECU-M-B12G5-C2-PB
	–	Straight plug, M12x1, 5-pin, for assembling a connecting cable compatible with FBA-2-M12-5POL-RK for PROFIBUS	1066354	NECU-M-S-B12G5-C2-PB
	–	Terminating resistor, M12, B-coded for PROFIBUS	1072128	CACR-S-B12G5-220-PB
	–	Plug M12x1, 4-pin, D-coded for EtherCAT	543109	NECU-M-S-D12G4-C2-ET

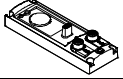
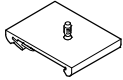
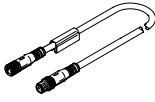
Valve terminals VTOC

Accessories

FESTO

Ordering data – CTEU			Part No.	Type
Electrical connecting plate				
	–	For connecting a second device with I-Port interface	570042	CAPC-F1-E-M12
H-rail mounting				
	–	For electrical connecting plate CAPC	570043	CAFM-F1-H
Connecting cable			Technical data → Internet: nebu	
	–	<ul style="list-style-type: none"> • Straight socket, M12x1, 5-pin • Straight plug, M12x1, 5-pin • Nominal conductor cross section 1 mm² 	5 m	574321 NEBU-M12G5-E-5-Q8N-M12G5
			7.5 m	574322 NEBU-M12G5-E-7.5-Q8N-M12G5
			10 m	574323 NEBU-M12G5-E-10-Q8N-M12G5
	–	<ul style="list-style-type: none"> • Angled socket, M12x1, 5-pin • Angled plug, M12x1, 5-pin 	0.5 m	570733 NEBU-M12W5-K-0.5-M12W5
			2 m	570734 NEBU-M12W5-K-2-M12W5
	–	<ul style="list-style-type: none"> • Straight socket, M12x1, 5-pin • Angled plug, M12x1, 5-pin 	0.5 m	8003617 NEBU-M12G5-K-0.5-M12W5
		2 m	8003618 NEBU-M12G5-K-2-M12W5	
Plug socket				
	–	For power supply, M12x1, 5-pin, B-coded for CANopen/DeviceNet	538999	NTSD-GD-9-M12-5POL-RK
	–	For power supply, M12x1, 5-pin for CC-Link, PROFIBUS, EtherCAT	18324	FBSD-GD-9-5POL
Connection technology for IO-Link				
	XM	T-adapter M12, 5-pin for IO-Link and load supply	171175	FB-TA-M12-5POL
Straight plug, for I-Port interface/IO-Link				
	XN	M12, 5-pin, in combination with T-adapter for separate load voltage	175487	SEA-M12-5GS-PG7
Plug socket				
	–	For bypassing the interlock function	1589339	NEFF-S1G44LB
Inscription label				
	–	For bus node	565306	ASLR-C-E4