

MVSY-100 系列

電磁閥

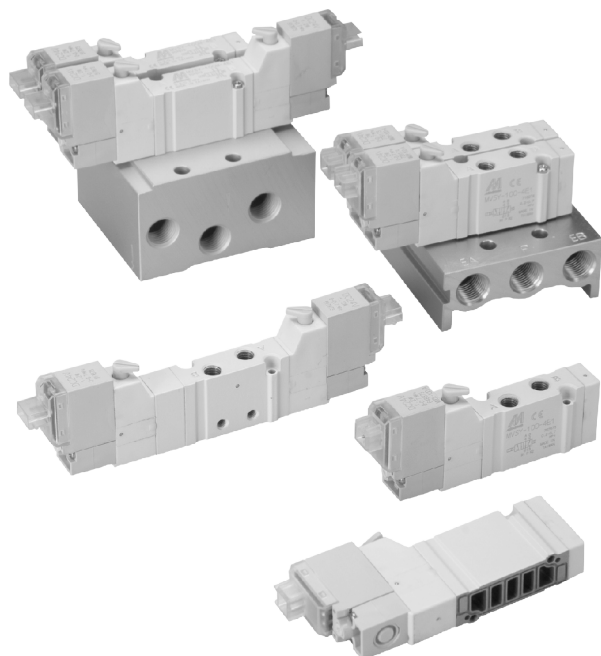

規格：

型號	4E1	4E2	4E2C.P.R
配管口徑代號	M5		
配管口徑尺寸	M5×0.8		
方口數	5口		
位置數	2位置	3位置	
使用流體	空氣		
使用壓力範圍	0.2~0.7 MPa		
耐壓力	1 MPa		
有效斷面積	直配管型	4.5 mm ²	4.5 mm ²
	連座型	4.5 mm ²	4.5 / 5 / 4.5 mm ²
應答時間	12 ms	15 ms	
周圍溫度	+5~+50℃		
定格電壓	AC110V, AC220V(50/60)Hz, DC6/12/24V		
電力消耗	AC=1.6 / 2.5VA, DC=0.55W (附燈型)		
電壓容許範圍	±10%		
絕緣等級	B 級		
重量	30g	43g	55g

閥 / 訂購代號：

MVSY - 100M - 4E2C - AC110 - LJ1

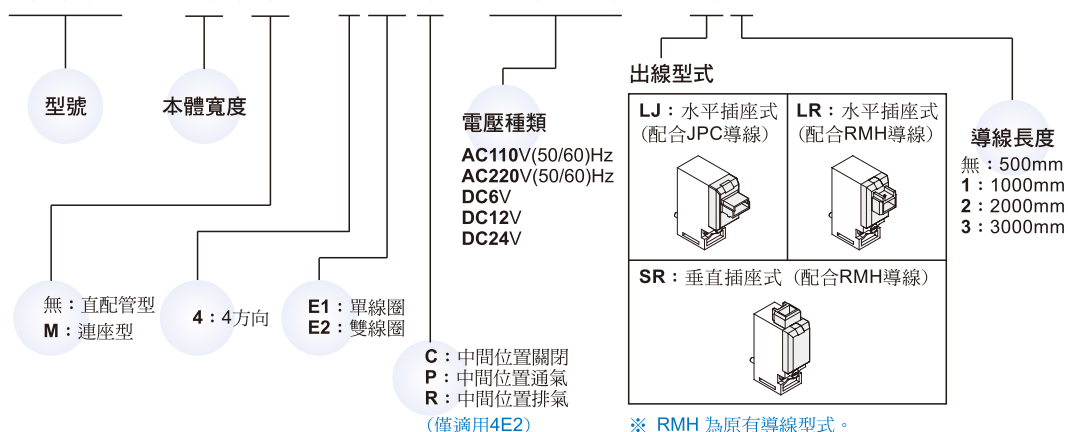

連座 / 訂購代號：

MVSY - 100M - 5M3 - G

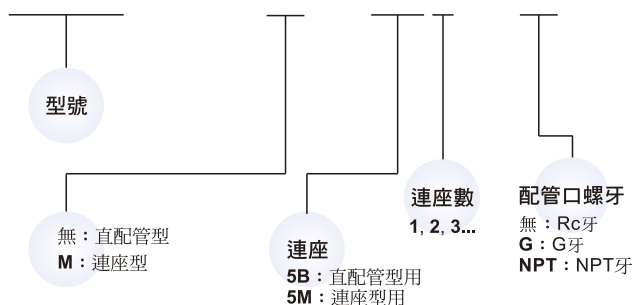

導線 / 訂購代號：※ 與 MVDY 共用導線

MVDY - 100 - WA2J2

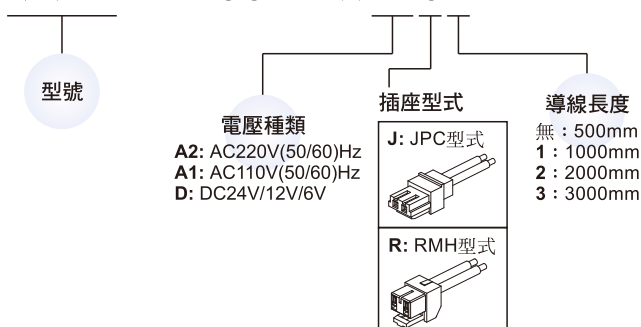

Mindman

MVSY-100 外觀尺寸

電磁閥



MVSY-100-4E1

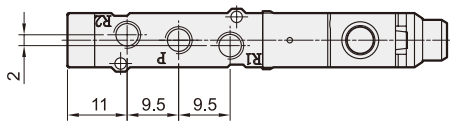
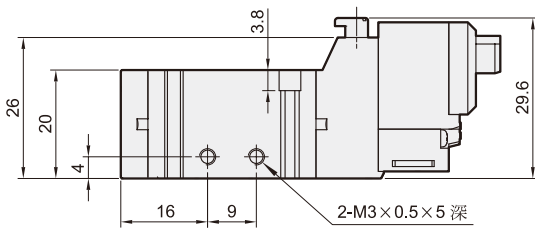
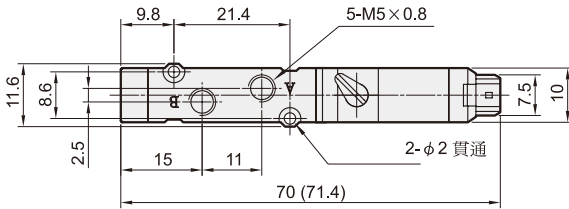
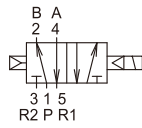

MVSY-100-4E2

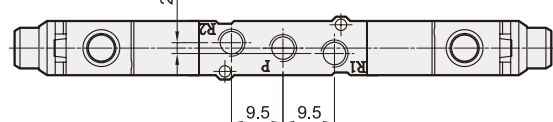
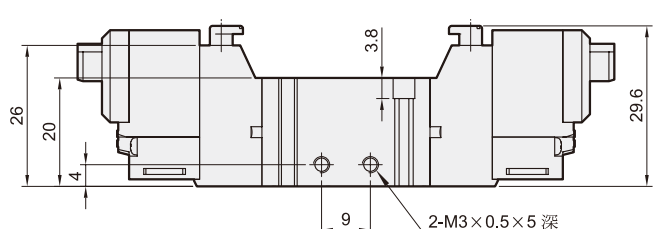
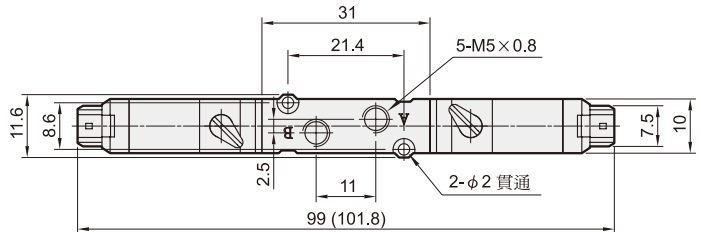
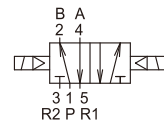

MVSY-100-4E2C.P.R

MVSY-100-4E2C

MVSY-100-4E2P

MVSY-100-4E2R

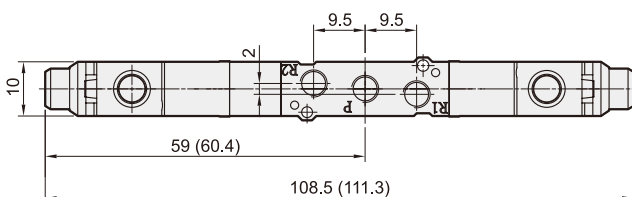
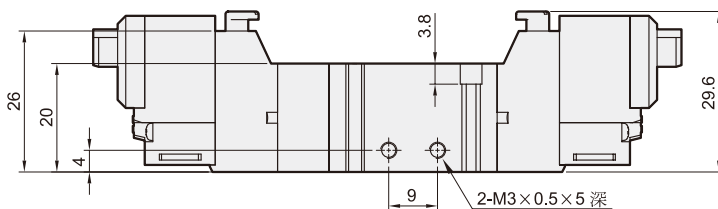
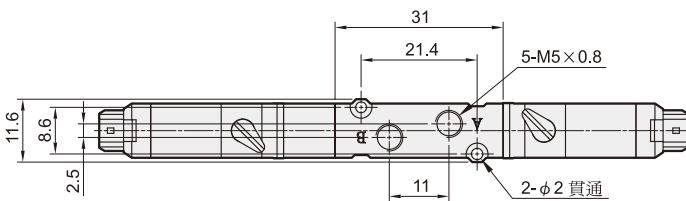
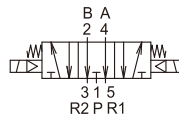
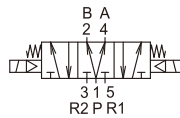
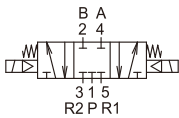

流量特性圖：

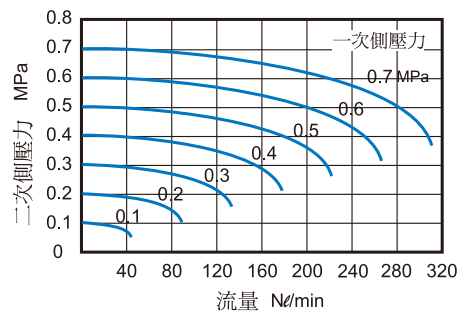

() : LJ 出線型式尺寸



Mindman

MVSY-100 連座

電磁閥

MVSY-100-5B*

直配管型用

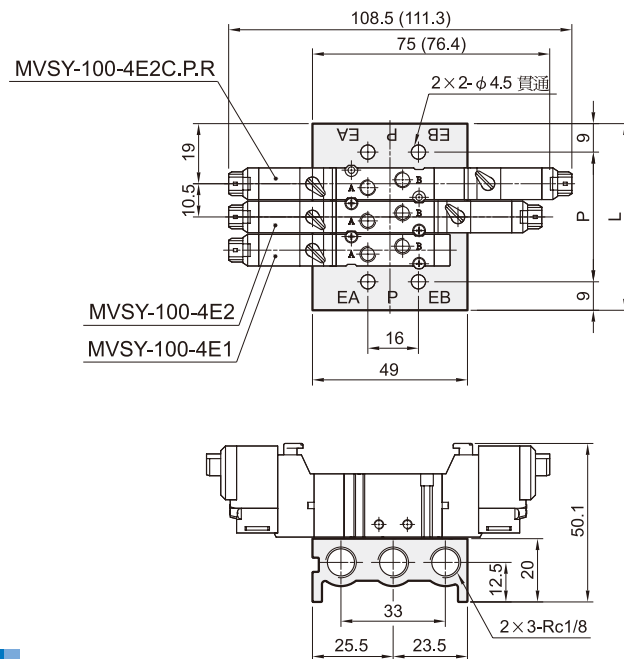

連座數(N)	P	L
2	30.5	48.5
3	41	59
4	51.5	69.5
5	62	80
6	72.5	90.5
7	83	101
8	93.5	111.5
9	104	122
10	114.5	132.5

MVSY-100M-5M*

連座型用

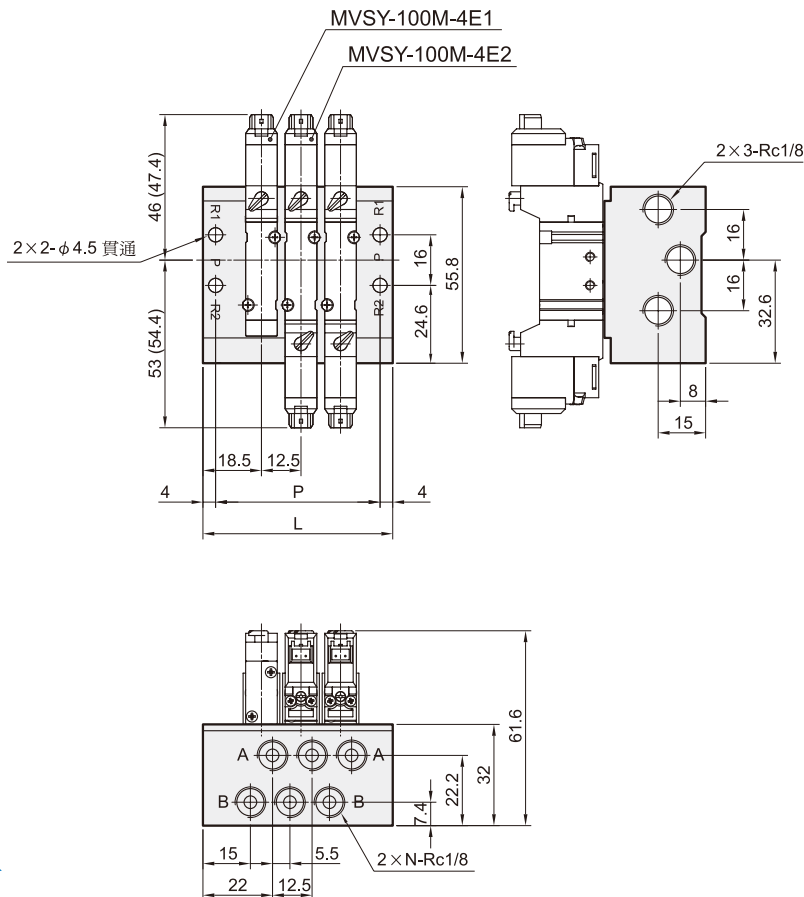

連座數(N)	P	L
2	39.5	47.5
3	52	60
4	64.5	72.5
5	77	85
6	89.5	97.5
7	102	110
8	114.5	122.5
9	127	135
10	139.5	147.5

(): LJ 出線型式尺寸

MVSY-100 安裝配件

電磁閥

支架 / 訂購代號：

MVSY - 100 - 1A

安裝配件
1A：支架
2A：腳架

MVSY-100-1A

支架

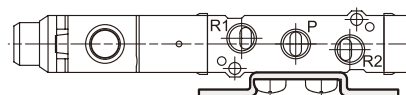
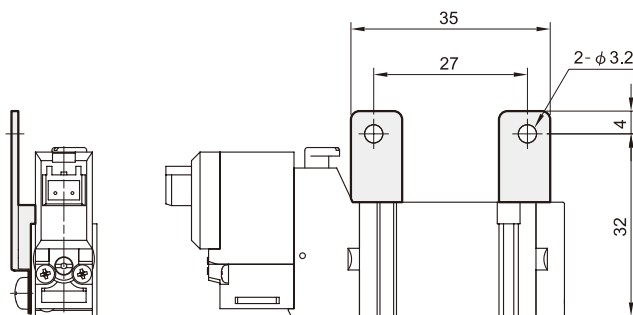
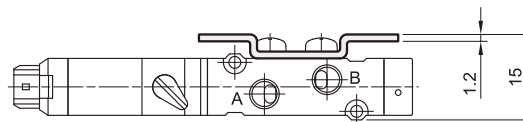
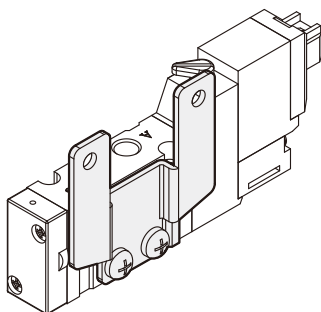

MVSY-100-2A

腳架

