

MAIR200 系列

空氣調理組合(精密調壓器)

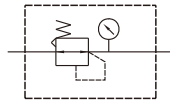

符號:



規格:

型號	MAIR200
配管口徑代號	8A
配管口徑尺寸	1/4
使用流體	空氣
最高使用壓力	1 MPa
最低使用壓力	設定壓力 + 0.05 MPa
耐壓力	1.5 MPa
設定壓力範圍	2K: 0.005~0.2 MPa
	4K: 0.01~0.4 MPa
	8K: 0.01~0.8 MPa
靈敏度	0.2% F.S. 以內
重覆精度	±0.5% F.S.以內
空氣消耗量 (※1)	4.4 l/min(ANR)以內
周圍溫度	-5~+60°C (不凍結)
附屬配件	支架
選用配件	壓力錶 (PG-40S)
重量	300 g

訂購代號:

MAIR200 - 8A - 2K - C - □

型號

配管口徑代號
8A: 1/4

壓力錶
(PG-40S)

配管口螺牙
無: Rc牙
G: G牙
NPT: NPT牙

設定壓力範圍
2K: 0.005~0.2 MPa
4K: 0.01~0.4 MPa
8K: 0.01~0.8 MPa

※1. 供給壓力1 MPa時。

※2. 釋氣口或排氣孔，常有空氣排出。

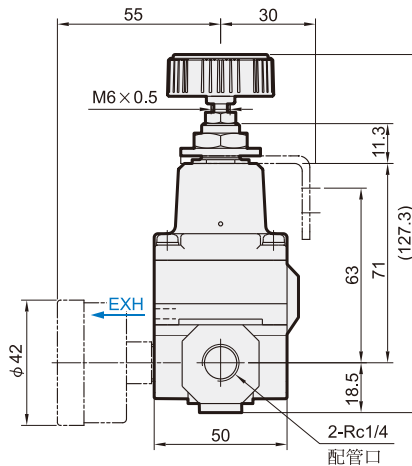
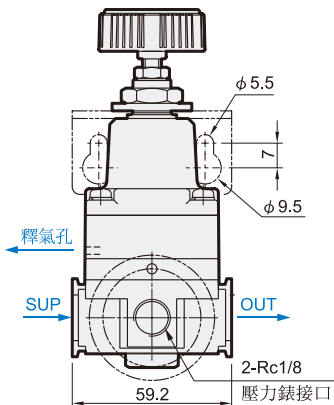
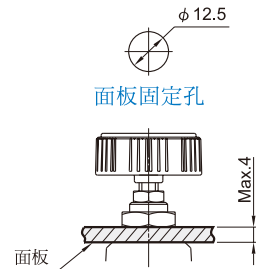
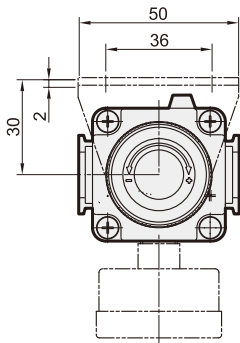

Mindman

MAIR200 性能圖表

空氣調理組合(精密調壓器)



mindman

流量特性圖：

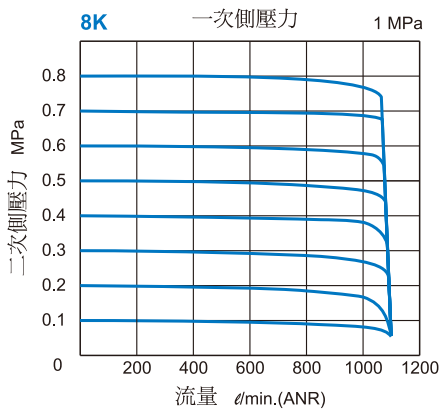
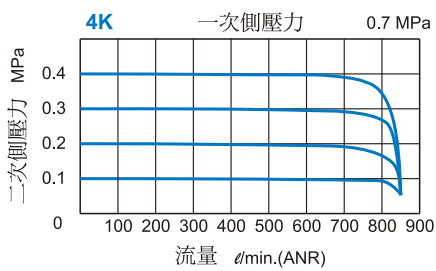
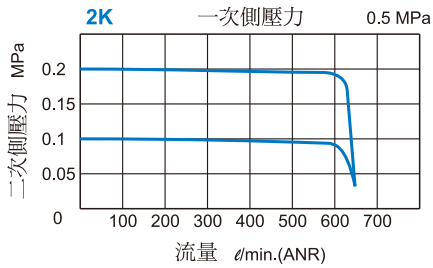

釋氣特性圖：

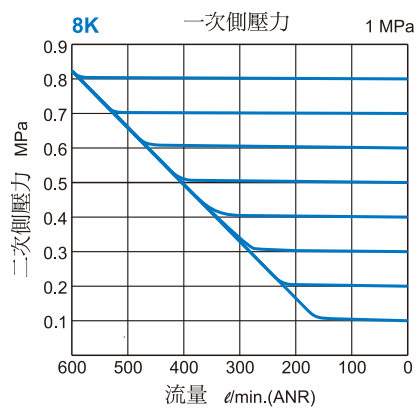
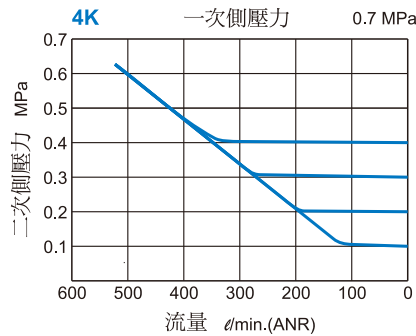
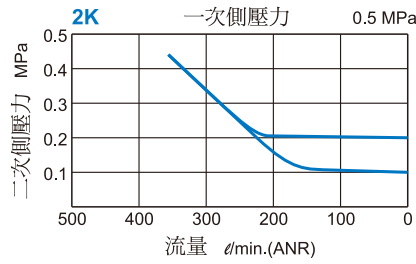

壓力特性圖：

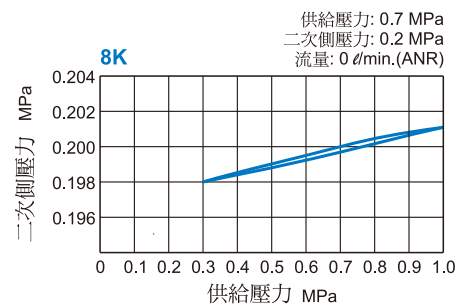
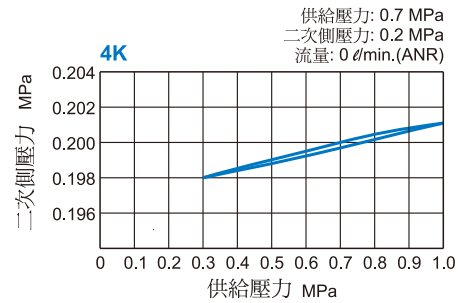
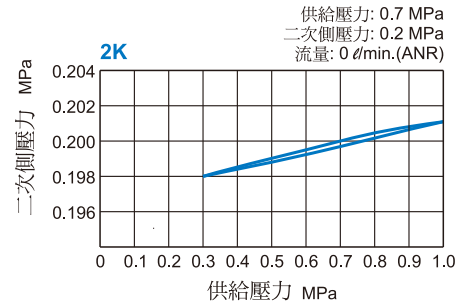

mindman