

薄型吸盘

吸盘直径 $\phi 5, \phi 6, \phi 11, \phi 14, \phi 18, \phi 20$

记号形状

UT 薄型
(裙部)

- 用于薄片、乙烯材料等的吸着。
吸着时可抑制折皱以及工件变形。
- 适用于ZP系列连接器。

型号表示方法

吸盘单体

ZP2-11 UT N

吸盘直径

| 记号 | 吸盘直径 |
|----|-----------|
| 05 | $\phi 5$ |
| 06 | $\phi 6$ |
| 11 | $\phi 11$ |
| 14 | $\phi 14$ |
| 18 | $\phi 18$ |
| 20 | $\phi 20$ |

吸盘形状

| 记号 | 形状 |
|----|--------|
| UT | 薄型(裙部) |

吸盘材质

| 记号 | 材质 |
|----|--------|
| N | NBR |
| S | 硅橡胶 |
| U | 聚氨酯橡胶 |
| F | FKM |
| GN | 导电性NBR |
| GS | 导电性硅橡胶 |



外形尺寸图/吸盘单体

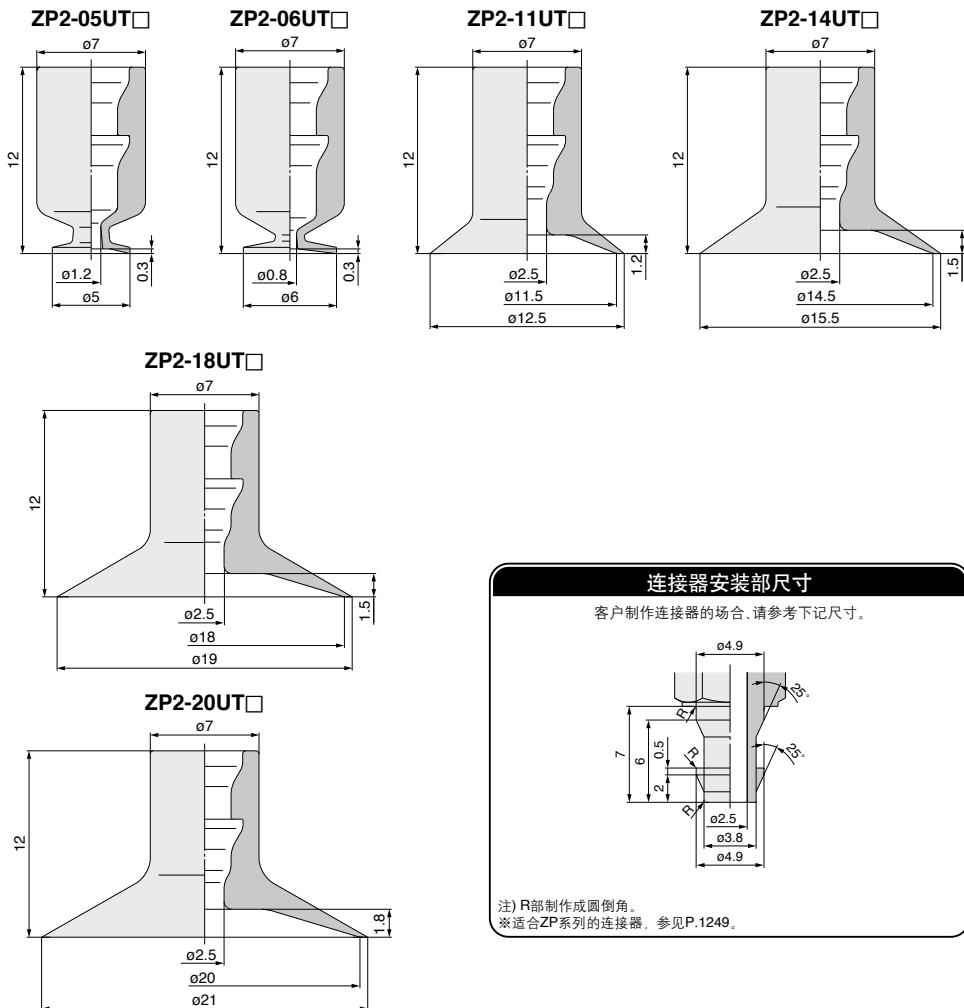

连接器安装部尺寸

客户制作连接器的场合,请参考下记尺寸。

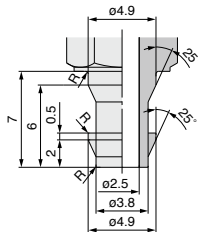

注) R部制作成圆倒角。
 ※适合ZP系列的连接器, 参见P.1249。

ZP3

ZP2

ZP2V

ZP

ZPT

ZPR

XT661



扁平型吸盘

记号形状

吸盘直径 $\phi 10, \phi 15, \phi 20, \phi 25, \phi 30$

MT 薄型(裙部)

■吸着面带沟。

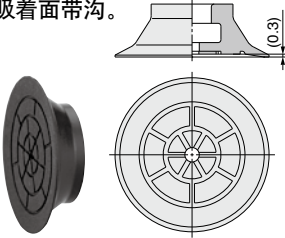

型号表示方法

吸盘单体的型号表示方法: **ZP2-B10 MT N**

| 记号 | 吸盘直径 | |
|-----|-----------|------|
| | 吸盘直径 | 喷沙规格 |
| B10 | $\phi 10$ | ● |
| B15 | $\phi 15$ | ● |
| B20 | $\phi 20$ | ● |
| B25 | $\phi 25$ | ● |
| B30 | $\phi 30$ | ● |

※喷沙规格: 工件剥离性加强。

| 吸盘材质 | |
|------|--------|
| 记号 | 材质 |
| N | NBR |
| S | 硅橡胶 |
| F | FKM |
| GN | 导电性NBR |
| GS | 导电性硅橡胶 |



■用于薄片、薄膜等的吸着。 吸着时可抑制工件平面的变形。

注1) 不适用于施加负载的工件的搬运。

注2) 根据薄板的厚度, 有可能发生折皱, 使用前请确认。

| 吸盘形状 | |
|------|--------|
| 记号 | 形状 |
| MT | 薄型(带沟) |

外形尺寸图/吸盘单体

ZP2-B10MT □

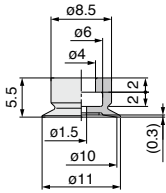

ZP2-B15MT □

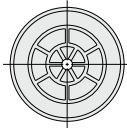
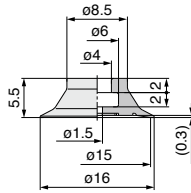

ZP2-B20MT □

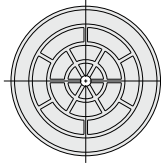
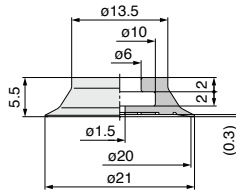

ZP2-B25MT □

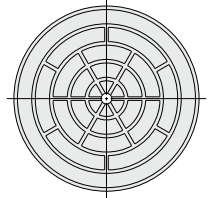
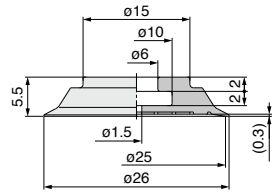

ZP2-B30MT □

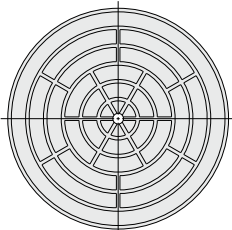
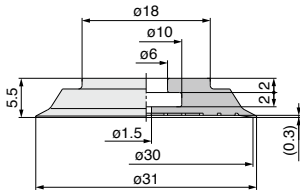

连接器安装部尺寸

客户制作连接器的场合, 请参考下记尺寸。

适合吸盘
B10MT/B15MT

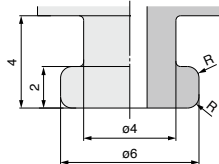

适合吸盘
B20MT/B25MT/B30MT

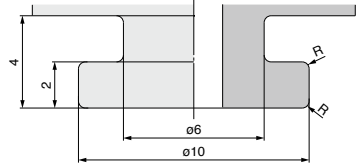

注) R部制作成圆倒角。

※适合ZP2系列的连接器, 参见P.1246。

型号表示方法



带连接器 **ZP2-T B10 MT N-H5**



吸盘直径

| 记号 | 吸盘直径 | 喷沙规格 |
|-----|------|------|
| B10 | φ10 | ● |
| B15 | φ15 | ● |
| B20 | φ20 | ● |
| B25 | φ25 | ● |
| B30 | φ30 | ● |

※喷沙规格: 工件脱离子加强。

吸盘形状

| 记号 | 形状 |
|----|--------|
| MT | 薄型(带沟) |

安装连接

| 螺纹径(记号) | 吸盘直径(记号) | B10 | B15 | B20 | B25 | B30 |
|----------------|----------|-----|-----|-----|-----|-----|
| H5(M5×0.8 外螺纹) | | ● | ● | ● | ● | ● |
| B5(M5×0.8 内螺纹) | | ● | ● | ● | ● | ● |

吸盘材质

| 记号 | 材质 |
|----|--------|
| N | NBR |
| S | 硅橡胶 |
| F | FKM |
| GN | 导电性NBR |
| GS | 导电性硅橡胶 |

更换型号

| 型号 | 吸盘单体型号 | 连接器型号 |
|----------------|------------|----------|
| ZP2-TB10MT□-H5 | ZP2-B10MT□ | ZP2A-M02 |
| ZP2-TB15MT□-H5 | ZP2-B15MT□ | |
| ZP2-TB20MT□-H5 | ZP2-B20MT□ | |
| ZP2-TB25MT□-H5 | ZP2-B25MT□ | ZP2A-M03 |
| ZP2-TB30MT□-H5 | ZP2-B30MT□ | |
| ZP2-TB10MT□-B5 | ZP2-B10MT□ | ZP2A-M04 |
| ZP2-TB15MT□-B5 | ZP2-B15MT□ | |

注) 表中□表示吸盘材质。

外形尺寸图/带连接器

ZP2-TB10MT□-H5

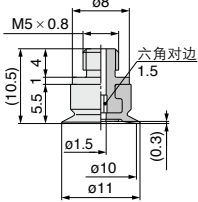

ZP2-TB15MT□-H5

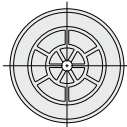
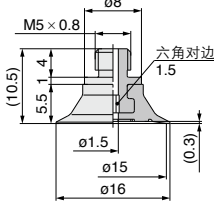

ZP2-TB20MT□-H5

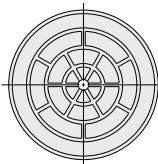
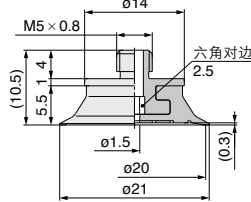

ZP2-TB25MT□-H5

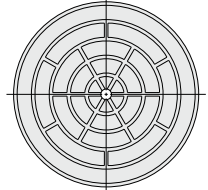
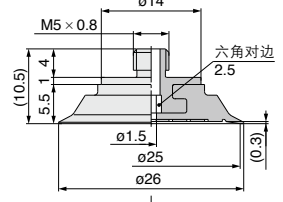

ZP2-TB30MT□-H5

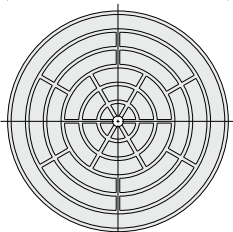
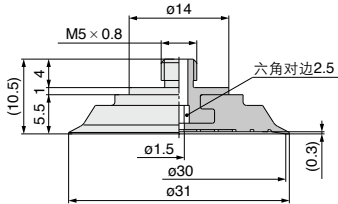

ZP2-TB10MT□-B5

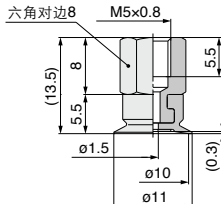

ZP2-TB15MT□-B5

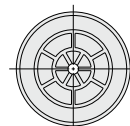
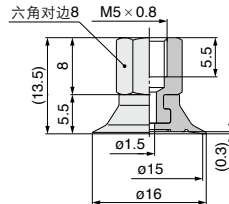

ZP3

ZP2

ZP2V

ZP

ZPT

ZPR

XT661