

Proportional pressure regulators VPPE

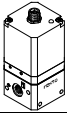
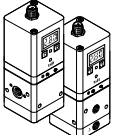

Proportional pressure regulators VPPE

Product range overview

Function	Version	Pneumatic connection	Nominal size for pressurisation/exhaust [mm]	Pressure regulation range [bar]	Setpoint input		→ Page/Internet
					Voltage type 0 ... 10 V	Current type 4 ... 20 mA	
Proportional pressure regulator	Without display						
		G1/8	5/2.5	0.15 ... 6	■	-	6
	With display						
		G1/8	5/2.5	0.02 ... 2	■	■	10
0.06 ... 6							
0.1 ... 10							

Proportional pressure regulators VPPE

Peripherals overview

FESTO

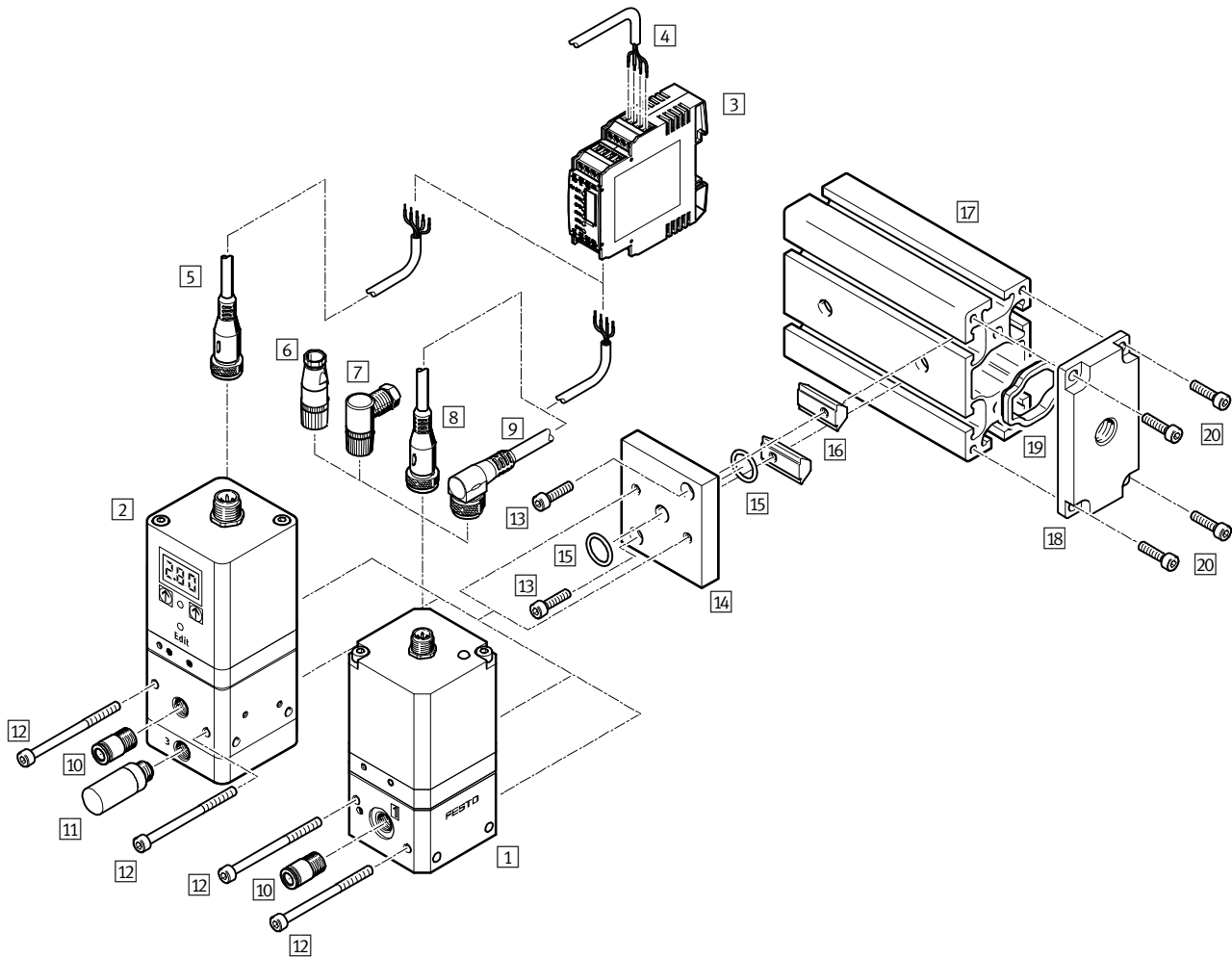

Accessories			
	Type	Brief description	→ Page/Internet
1	Prop. pressure regulator	VPPE...	8
2	Prop. pressure regulator with display	VPPE ... E1	13
3	Setpoint module	MPZ	For generating 6+1 analogue voltage signals
4	Digital input/output	–	For actuating the setpoint module
5	Connecting cable	SIM-M12-5GD-...-PU	With straight plug socket for actuating the VPPE...E1
6	Plug socket	SIE-GD	Straight plug socket for actuating the VPPE
7	Plug socket	SIE-WD-TR	Angled plug socket for actuating the VPPE
8	Connecting cable	SIM-M12-4GD-5PU	With straight plug socket for actuating the VPPE
9	Connecting cable	SIM-M12-4WD-5PU	With angled plug socket for actuating the VPPE
10	Push-in fitting	QS	For connecting compressed air tubing with standard O.D.
11	Silencer	U	For fitting in exhaust ports
12	Socket head screw M4x55	–	For screwing the VPPE to the mounting plate
13	Socket head screw M4x16	–	For screwing the mounting plate to the slot nut
14	Mounting plate (set)	VAME-P5-MK	For attaching the VPPE to the mounting rail (consists of mounting plate, slot nuts, screws and seals)
15	O-ring	–	For sealing
16	Slot nuts	–	For clamp fitting components on the mounting rail
17	Mounting rail	–	Standard mounting rail as central air supply
18	Compressed air supply plate (set)	VABF-P5-P3A3...	For supplying compressed air (consists of compressed air supply plate, screws and seal)
19	Seal	–	–
20	Socket head screw M5x12	–	For screwing a compressed air supply plate to the mounting rail

Proportional pressure regulators VPPE

Peripherals overview – Additional power supply

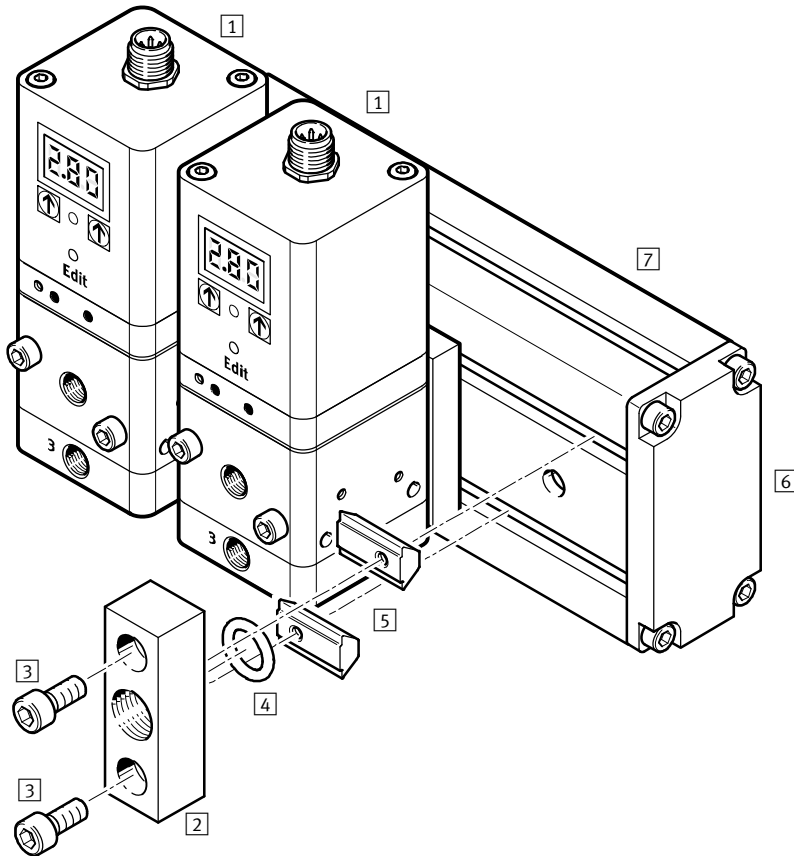

Accessories				
	Type	Brief description	→ Page/Internet	
1	Prop. pressure regulator with display	VPPE ... E1	-	13
2	Additional power supply module (set)	VABF-P5-P1A3...	For supplying compressed air (consists of compressed air supply plate, screws and seal)	15
3	Socket head screw M6x20	-	For screwing a compressed air supply plate to the slot nut	15
4	O-ring	-	For sealing	15
5	Slot nuts	-	For clamp fitting components on the mounting rail	15
6	End plate (set)	VABE-P5-C	For sealing the mounting rail (consists of an end plate, screws and seal)	15
7	Mounting rail	IPM-PN-08-40x80-AL	Standard mounting rail as central air supply	15

Proportional pressure regulators VPPE without display



Type codes

VPPE		-	3	-	1/8	-	6	-	010
Type									
VPPE	Proportional pressure regulator with switching valve head								
Valve function									
3	3-way pressure regulator								
Pneumatic connection									
1/8	G1/8 female thread								
Pressure regulation range									
6	0.15 ... 6 bar								
Analogue setpoint input									
010	0 ... 10 V								

Proportional pressure regulators VPPE without display

FESTO

Technical data

-  Flow rate
850 l/min
 -  Voltage
21.6 ... 26.4 V DC
 -  Pressure regulation range
0.15 ... 6 bar
- Variants
- Setpoint input as analogue voltage signal 0 ... 10 V



General technical data			
Pneumatic connection 1 and 2		G1/8	
Design, valve function		Piloted piston regulator, 3-way proportional pressure regulator, closed	
Sealing principle		Soft	
Actuation type		Electric	
Type of control		Piloted via 2/2-way valves	
Type of mounting		Via through-hole	
Mounting position		Any, preferably vertical	
Nominal size	Pressurisation	[mm]	5
	Exhaust	[mm]	2.5
Standard nominal flow rate		[l/min]	→ Graph
Product weight		[g]	445

Flow rate qn as a function of output pressure p2

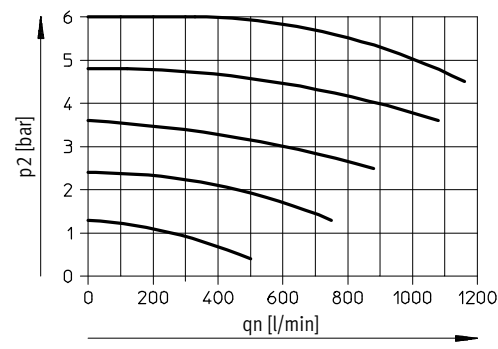

-  Note
Output pressure is maintained unregulated if the power supply cable is interrupted.

Electrical data	
Electrical connection	Plug, round design, 4-pin, M12x1
Operating voltage range	[V DC] 21.6 ... 26.4
Power supply indicator	LED
Residual ripple	[%] 10
Max. electrical power consumption	[W] 3.6
Max. current consumption	[mA] 150
Setpoint input signal	[V DC] 0 ... 10
Switching time on/off	[ms] 550/1300
Protection against short circuit/polarity reversal	For all electrical connections
Protection class	IP65

M12x1 – Pin allocation for VPPE

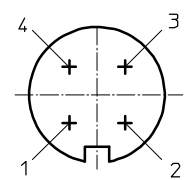

- 1 Supply
21.6 ... 26.4 V DC
- 2 Setpoint value (-)
- 3 GND (-)
- 4 Setpoint value (+) 0 ... 10 V DC

Circuit symbol

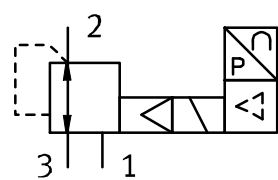

Proportional pressure regulators VPPE without display

Technical data

Operating and environmental conditions	
Operating medium	Compressed air according to ISO 8573-1:2010 [7:4:4] Inert gases
Note on operating/pilot medium	Lubricated operation not possible
Supply pressure 1	[bar] 7 ... 8
Pressure regulation range	[bar] 0.15 ... 6
Max. pressure hysteresis	[bar] 0.15
Ambient temperature	[°C] 10 ... 50
Temperature of medium	[°C] 10 ... 50
Corrosion resistance class CRC ¹⁾	2
CE marking (see declaration of conformity)	In accordance with EU EMC Directive ²⁾
Certification	RCM trademark
	c UL us - Listed (OL)

1) Corrosion resistance class CRC 2 to Festo standard FN 940070

Moderate corrosion stress. Indoor applications in which condensation may occur. External visible parts with primarily decorative requirements for the surface and which are in direct contact with the ambient atmosphere typical for industrial applications.

2) For information about the applicability of the component see the manufacturer's EC declaration of conformity at: www.festo.com/sp → Certificates.

If the component is subject to restrictions on usage in residential, office or commercial environments or small businesses, further measures to reduce the emitted interference may be necessary.

Materials	
Housing	Wrought aluminium alloy
Diaphragm	NBR
Note on materials	RoHS-compliant

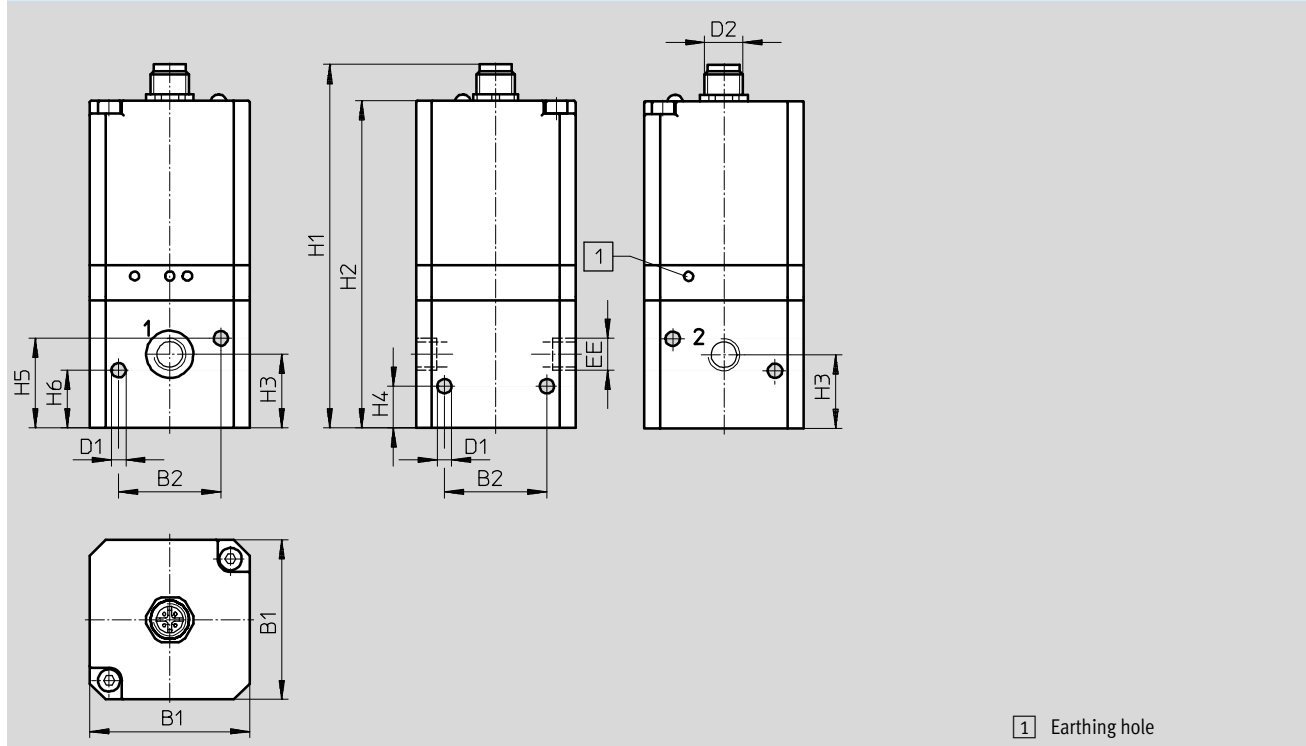

Dimensions Download CAD data → www.festo.com



Type	B1	B2	∅D1	D2	EE	H1	H2	H3	H4	H5	H6
VPPE-3-1/8-6-010	50	32	4.5	M12x1	G1/8	114	102	23	13	28	18

Proportional pressure regulators VPPE without display

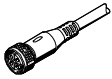
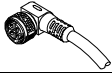
Ordering data

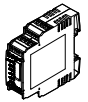
Ordering data			
	Description	Part No.	Type
Proportional pressure regulator VPPE without display			
	<ul style="list-style-type: none"> • Pressure regulation range: 0 ... 6 bar • Pneumatic connection: G1/8 	539639	VPPE-3-1/8-6-010
Plug socket with cable Technical data → Internet: nebu			
	<ul style="list-style-type: none"> • Straight socket, M12x1, 5-pin • Open end, 4-wire, cable length 5 m 	164259	SIM-M12-4GD-5-PU
	<ul style="list-style-type: none"> • Angled socket, M12x1, 5-pin • Open end, 4-wire, cable length 5 m 	164258	SIM-M12-4WD-5-PU
Plug socket Technical data → Internet: sie-gd			
	Straight socket, M12x1, 4-pin	18494	SIE-GD
	Angled socket, M12x1, 4-pin	12956	SIE-WD-TR
Setpoint module Technical data → Internet: mpz			
	Setpoint module for generating 6 + 1 analogue voltage signals	546224	MPZ-1-24DC-SGH-6-SW

Proportional pressure regulators VPPE with display



Type codes

VPPE – 3 – 1 – 1/8 – 6 – 010 – E1 T

Type	
VPPE	Proportional pressure regulator with switching valve head
Directional control function	
3	3-way pressure regulator
Valve function	
1	Normally closed
Pneumatic connection	
1/8	G1/8 female thread
Pressure regulation range	
2	0.02 ... 2 bar
6	0.06 ... 6 bar
10	0.1 ... 10 bar
Analogue setpoint input	
010	0 ... 10 V
420	4 ... 20 mA
Operator unit	
E1	Segmented LED display
Assembly	
–	In-line valve
T	Common supply manifold assembly (mounting rail)

Proportional pressure regulators VPPE with display

Technical data

-  Flow rate
310 ... 1250 l/min
 -  Voltage
21.6 ... 26.4 V DC
 -  Pressure regulation range
0.02 ... 2 bar
0.06 ... 6 bar
0.1 ... 10 bar
- Variants
- Setpoint input as analogue voltage signal 0 ... 10 V
 - Setpoint input as analogue current signal 4 ... 20 mA
 - Assembly as in-line valve or on mounting rail
 - 3-digit LED display



General technical data			
Pneumatic connection 1, 2, 3		G1/8	
Design, valve function		Piloted diaphragm regulator, 3-way proportional pressure regulator	
Sealing principle		Soft	
Actuation type		Electric	
Reset method		Mechanical spring	
Type of control		Piloted via 2/2-way valves	
Type of mounting		Via through-hole	
Mounting position		Any, preferably vertical	
Nominal size	Pressurisation	[mm]	5
	Exhaust	[mm]	2.5
Standard nominal flow rate		[l/min]	→ Graphs
Product weight		[g]	390

Flow rate qn as a function of output pressure p2

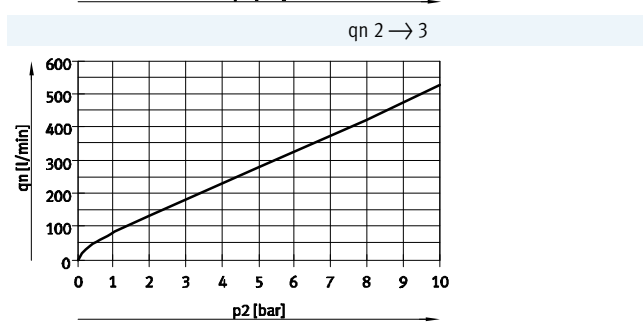
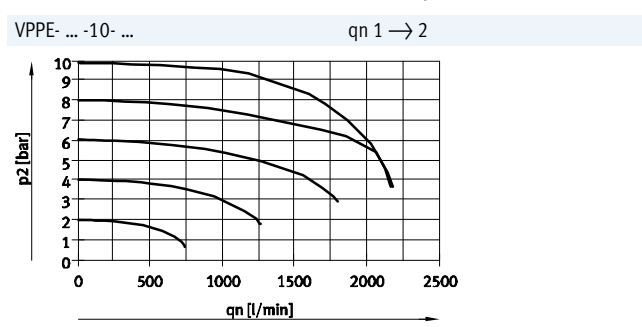
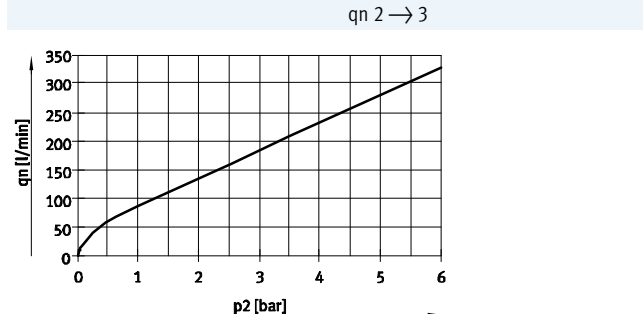
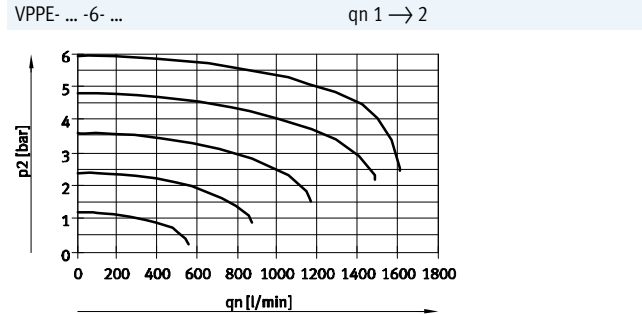
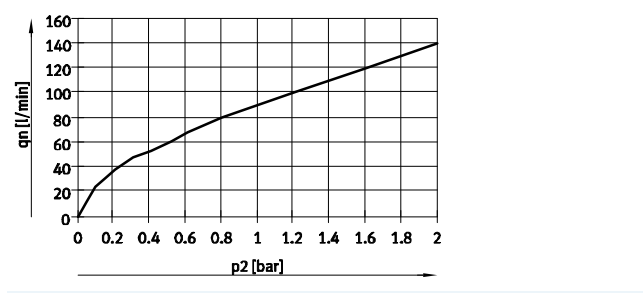
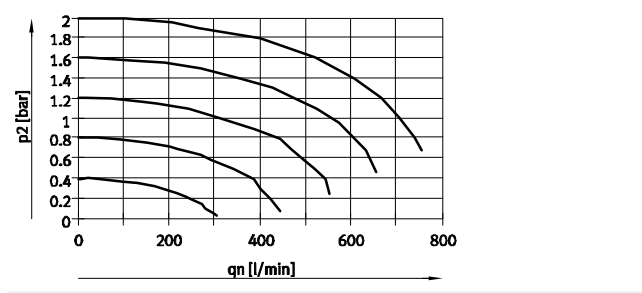

Proportional pressure regulators VPPE with display

Technical data

Electrical data			
Electrical connection	Plug, round design, 5-pin, M12x1		
Operating voltage range	[V DC]	21.6 ... 26.4	
Power supply indicator	LED		
Residual ripple	[%]	10	
Max. electrical power consumption	[W]	4.2	
Analogue signal range	Voltage	[V DC]	0 ... 10
Output/input	Current	[mA]	4 ... 20
Protection against short circuit	For all electrical connections		
Switching output	PNP		
Protection against incorrect polarity	For all electrical connections		
Protection class	IP65		

Operating and environmental conditions				
Pressure regulation range	[bar]	0.02 ... 2	0.06 ... 6	0.1 ... 10
Operating medium	Compressed air according to ISO 8573-1:2010 [7:4:4] Inert gases			
Note on operating/pilot medium	Lubricated operation not possible			
Supply pressure 1 ¹⁾	[bar]	3 ... 4	6 ... 8	6 ... 11
Max. pressure hysteresis	[mbar]	20	30	50
FS (full scale) linearity error	[%]	± 1		
FS (full scale) repetition accuracy	[%]	0.5		
Temperature coefficient	[%/K]	0.04		
Duty cycle	[%]	100		
Ambient temperature	[°C]	0 ... 60		
Temperature of medium	[°C]	10 ... 50		
Corrosion resistance class	[CRC]	2 ²⁾		
CE marking (see declaration of conformity)	To EU EMC Directive ³⁾			
Certification	RCM trademark c UL us - Listed (OL)			

- 1) Supply pressure 1 should always be 1 bar greater than the maximum regulated output pressure.
- 2) Corrosion resistance class CRC 2 to Festo standard FN 940070
Moderate corrosion stress. Indoor applications in which condensation may occur. External visible parts with primarily decorative requirements for the surface and which are in direct contact with the ambient atmosphere typical for industrial applications.
- 3) For information about the applicability of the component see the manufacturer's EC declaration of conformity at: www.festo.com/sp → Certificates.
If the component is subject to restrictions on usage in residential, office or commercial environments or small businesses, further measures to reduce the emitted interference may be necessary.

Pin allocation for VPPE with display, M12x1

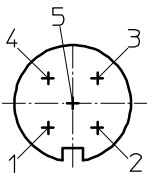

- 1 Supply
21.6 ... 26.4 V DC
- 2 Setpoint value (-)
- 3 GND (-)
- 4 Setpoint value (+) 0 ... 10 V DC /
4 ... 20 mA
- 5 Actual value output or switching
output (can be chosen via the
control panel)

Circuit symbol

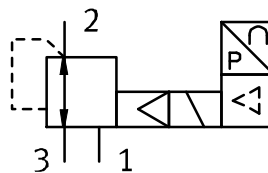

Materials	
Housing	Anodised wrought aluminium alloy
Note on materials	RoHS-compliant Free of copper and PTFE

- - Note

Output pressure remains unregulated if the power supply cable is interrupted.

Proportional pressure regulators VPPE with display

Technical data

FESTO

Dimensions

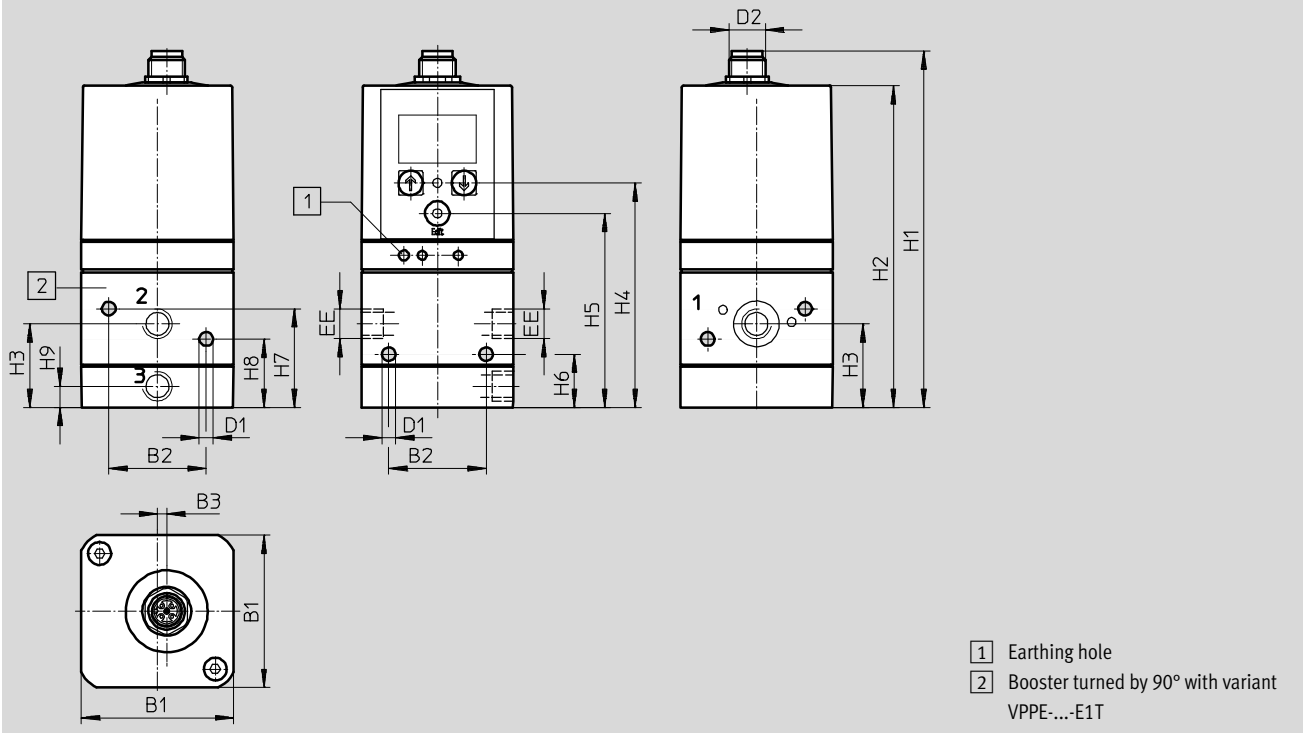

Download CAD data → www.festo.com



Type	B1	B2	B3	∅ D1	D2	EE	H1	H2	H3	H4	H5	H6	H7	H8	H9
VPPE-3-1/8- ... E1 ...	50	32	3.1	4.5	M12x1	G1/8	117.2	105.8	27.5	73.8	63.8	17.5	32.5	22.5	7

Proportional pressure regulators VPPE with display

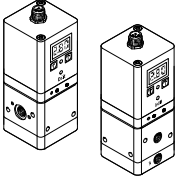
Ordering data

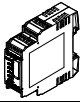
Ordering data			
	Description	Part No.	Type
Proportional pressure regulator VPPE with display			
	Voltage type 0 ... 10 V		
	Pressure regulation range 0.02 ... 2 bar	557771	VPPE-3-1-1/8-2-010-E1
		557777	VPPE-3-1-1/8-2-010-E1T
	Pressure regulation range 0.06 ... 6 bar	557772	VPPE-3-1-1/8-6-010-E1
		567539	VPPE-3-1-1/8-6-010-E1T
	Pressure regulation range 0.1 ... 10 bar	557773	VPPE-3-1-1/8-10-010-E1
		557778	VPPE-3-1-1/8-10-010-E1T
	Current type 4 ... 20 mA		
	Pressure regulation range 0.02 ... 2 bar	557774	VPPE-3-1-1/8-2-420-E1
		557779	VPPE-3-1-1/8-2-420-E1T
	Pressure regulation range 0.06 ... 6 bar	557775	VPPE-3-1-1/8-6-420-E1
		567540	VPPE-3-1-1/8-6-420-E1T
Pressure regulation range 0.1 ... 10 bar	557776	VPPE-3-1-1/8-10-420-E1	
	557780	VPPE-3-1-1/8-10-420-E1T	
Connecting cable Technical data → Internet: nebu			
	<ul style="list-style-type: none"> • Straight socket, M12x1, 5-pin • Open end, 5-wire 	2.5 m	175715 SIM-M12-5GD-2,5-PU
		5 m	175716 SIM-M12-5GD-5-PU
Setpoint module Technical data → Internet: mpz			
	Setpoint module for generating 6 + 1 analogue voltage signals	546224	MPZ-1-24DC-SGH-6-SW

Mounting rail for proportional pressure regulators VPPE

Technical data



General

Design

Some selected types of the pressure regulator VPPE can be screwed to a mounting rail. This has the advantage that the mounting rail can be used to create a central compressed air supply.
The air can be fed into the mounting rail:

- at one end or
- at both ends through end plates,
- using an intermediate air supply module (in applications where an increased air rate is required).

The holes for the mounting rail must be drilled according to the assembly instructions. The pressure regulators VPPE are screwed to the mounting rail using the mounting plate. The end

plates are screwed to the left and right end faces of the mounting rail. See the assembly instructions for further information:
➔ Internet: vppe

Compressed air supply on the mounting rail

When using the mounting rail as a central compressed air supply, make sure that the required compressed air supply is guaranteed. Bear in mind

that an intermediate air supply module needs a valve position. The intermediate air supply module takes up one VPPE valve position.

Recommendation for compressed air supply

E.g. with tubing Ø 16 mm with simultaneous max. flow rate for all valves, the following applies:
Compressed air supply – number of valves:

- At one end – max. 5 valves
- At both ends – max. 10 valves
- With intermediate air supply module – max. 5 valves per module

Note

- Intermediate air supply modules must always be centred on the mounting rail.
- Multiple intermediate air supply modules must be evenly distributed.

Note

Only the following types of proportional pressure regulators VPPE can be mounted on mounting rails using a mounting plate:

- Valve VPPE with LED display, VPPE-3-1/8-6-010
- Valve VPPE with display and top part rotated by 90° VPPE- ... -E1T

Further information on mounting proportional pressure regulators VPPE as well as intermediate air supply modules on mounting rails can be found in the assembly instructions:
➔ Internet: vppe

Mounting plate (set) materials	
Plate	Wrought aluminium alloy
Seals	NBR
Screws	Steel
Note on materials	RoHS-compliant
Corrosion resistance class	[CRC] 2 ¹⁾

1) Corrosion resistance class CRC 2 to Festo standard FN 940070
Moderate corrosion stress. Indoor applications in which condensation may occur. External visible parts with primarily decorative requirements for the surface and which are in direct contact with the ambient atmosphere typical for industrial applications.

Dimensions – Mounting plate Download CAD data ➔ www.festo.com

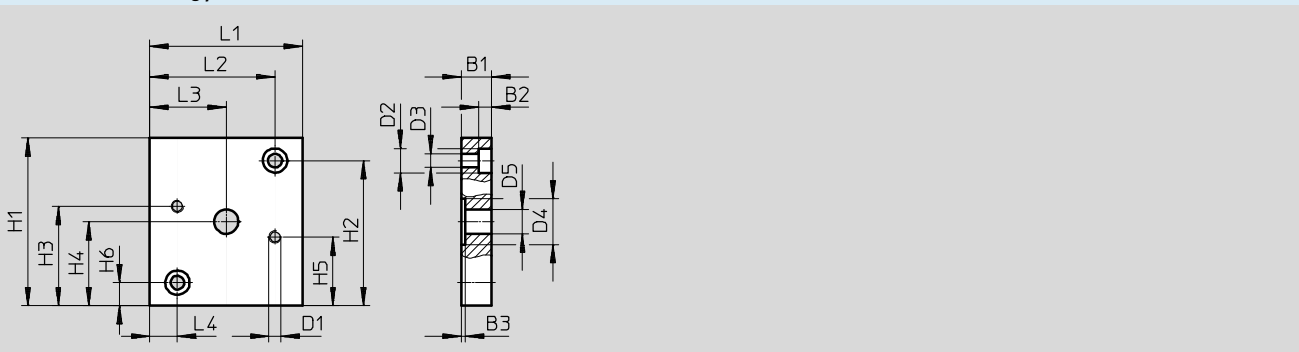

Type	B1	B2	B3	D1	∅D2	∅D3	∅D4	∅D5	H1	H2	H3	H4	H5	H6	L1	L2	L3	L4
VAME-P5-MK	10	4.6	1.3	M4	8	4.5	15	8	55	47.5	32.5	27.5	22.5	7.5	50	41	25	9

Mounting rail for proportional pressure regulators VPPE

Ordering data

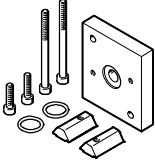
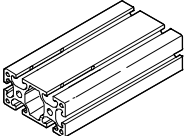
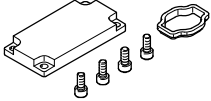
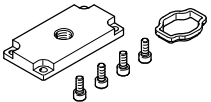
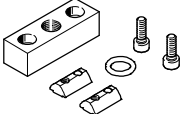
Ordering data		Part No.	Type
Mounting plate set			
	Set, consisting of: <ul style="list-style-type: none"> • 1x mounting plate, weight: 110 g • 2x socket head screws M4X55 • 2x socket head screws M4X16 • 2x slot nuts • 2x O-rings 	570966	VAME-P5-MK
Profile column (mounting rail)			
	Made from aluminium, as central air supply, length: individually adaptable	175964	HMBS-80/40- -
End plate set (closed)			
	For sealing the mounting rail, consisting of: <ul style="list-style-type: none"> • 1x plate • 1x seal • 4x socket head screws M5x12 	8021858	VABE-P5-C
Compressed air supply plate set			
	With connecting thread G1/4, consisting of: <ul style="list-style-type: none"> • 1x plate with connecting thread G1/4 • 1x seal • 4x socket head screws M5x12 	8021859	VABF-P5-P3A3-G14
	With connecting thread G3/8, consisting of: <ul style="list-style-type: none"> • 1x plate with connecting thread G3/8 • 1x seal • 4x socket head screws M5x12 	8021860	VABF-P5-P3A3-G38
	With connecting thread G1/2, consisting of: <ul style="list-style-type: none"> • 1x plate with connecting thread G1/2 • 1x seal • 4x socket head screws M5x12 	8021861	VABF-P5-P3A3-G12
Additional power supply module set			
	Connection G1/4, consisting of: <ul style="list-style-type: none"> • 1x plate with connecting thread G1/4 • 1x O-ring • 2x slot nuts • 2x socket head screws M6x20 	8021862	VABF-P5-P1A3-G14
	Connection G3/8, consisting of: <ul style="list-style-type: none"> • 1x plate with connecting thread G3/8 • 1x O-ring • 2x slot nuts • 2x socket head screws M6x20 	8021863	VABF-P5-P1A3-G38