

Series 11-CRA1-Z

Rack & Pinion Type Rotary Actuator
Size: 30, 50

RoHS

How to Order

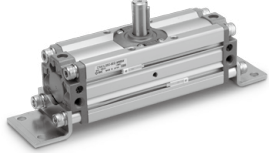

Clean series

11	Vacuum suction type
----	---------------------

Auto switch

Nil	No
D	Built-in magnet

Mounting

B	Basic
L	Foot

Shaft type

S	Single shaft
W	Double shaft

Size

30
50

Rotating angle

90	90°
180	180°
100	100°*
190	190°*

* Not available for ø30

Cushion

Nil	Without air cushion
C	With air cushion on both ends

Number of auto switches

Nil	2 pcs.
S	1 pc.

Type of auto switch (For model with auto switch)

Nil	Without auto switch (Built-in magnet cylinder)
-----	--

* For the applicable auto switch model, refer to the table below.
* Auto switches are shipped together, (but not assembled).

Ordering Code: 11 - C D R A 1 B S 50 - 90 [] Z - M9B []

Specifications

Size	30	50
Fluid	Air (Non-lube)	
Maximum operating pressure	1 MPa	
Minimum operating pressure	0.1 MPa	
Ambient and fluid temperature	0 to 60°C	
Cushion	With air cushion	Without air cushion, With air cushion
Allowable kinetic energy (J)	Without air cushion	0.01
	With air cushion	0.12
Cushion angle	35°	
Adjustable range of rotation time	0.2 to 1 s/90°	0.2 to 2 s/90°
Port size	M5 x 0.8 Rc1/8	
Mounting	Basic, Flange	
Grease	Fluorine grease	
Cleanliness class (ISO class)	Class 4	

* The maximum absorbed energy under proper adjustment of the cushion valve

Suction Flow Rate of Vacuum Suction Type (Reference values)

Size	Suction flow rate L/min (ANR)
30	1
50	5

Auto Switch Specifications (Refer to the WEB catalog for detailed specifications and auto switches not in the following table.)

Type	Auto switch part no.	Load voltage	Load current range	Indicator light	Application
Solid state	2-wire D-M9B	24 VDC (10 to 28 VDC)	2.5 to 40 mA	○	24 VDC relay, PLC
auto switch	3-wire D-M9N, D-M9P	28 VDC or less	40 mA or less	○	IC circuit, Relay, PLC
Reed auto switch	D-A93	24 VDC, 100 VAC	5 to 40 mA, 5 to 20 mA	○	Relay, PLC

Refer to page 920 for the applicable auto switch list.

PLC: Programmable Logic Controller

Rotation Range of Keyway/Switch Mounting Position

11-CDRA1□□30

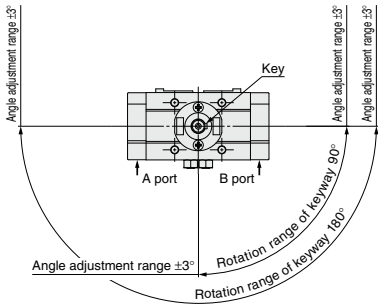

11-CDRA1□□50

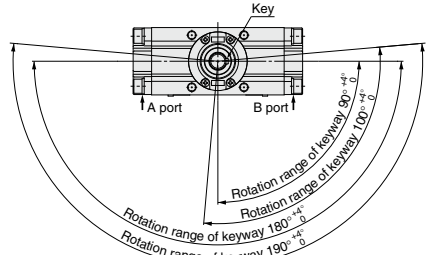

* The shaft rotates clockwise when the pressure is applied from the A port while it rotates counterclockwise when the pressure is applied from the B port.

Auto Switch Proper Mounting Position (Detection at Rotation End)

11-CDRA1□□30

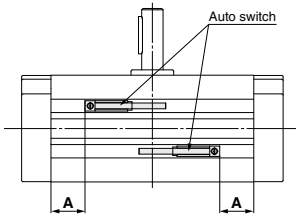

11-CDRA1□□50

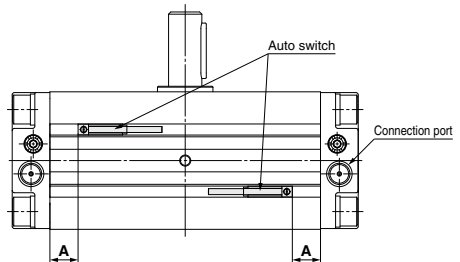

Note) For size 30, the auto switch cannot be mounted on the connection port side since there is a vacuum port.

Size	Rotating angle	D-M9□/M9□V D-M9□W/M9□WV D-M9□A/M9□AV		D-A9□/A9□V	
		Proper mounting position A (mm)	Operating range θ (°)	Proper mounting position A (mm)	Operating range θ (°)
30	90	13	42°	9	81°
	180	22		18	
50	90	22.5	30°	18.5	44°
	180	39		35	

* Values which include hysteresis are for guideline purposes only, they are not a guarantee (assuming approximately ±30% dispersion) and may change substantially depending on the ambient environment. Adjust the auto switch after confirming the operating conditions in the actual setting.

Switch Spacer Part No.

Size	30	50
Switch spacer part no.	BM Y3-016	

* The above part number includes one switch spacer.
* Two switch spacers are included with the product with built-in magnet.

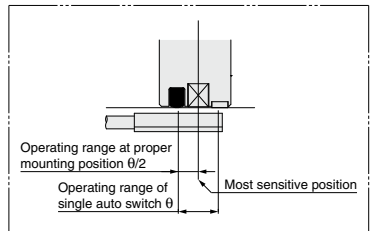

Directional Control Valves
Air Cylinders
Rotary Actuators
Air Grippers
Air Preparation Equipment
Modular F. R.
Pressure Control Equipment
Fittings & Tubing
Flow Control Equipment
Pressure Switches/ Pressure Sensors

Dimensions: Basic Type, 11-C□RA1□S30

Size: 30

Single shaft

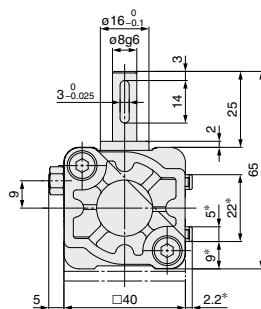
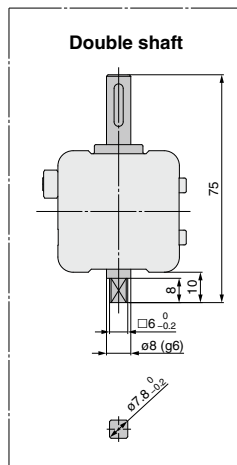
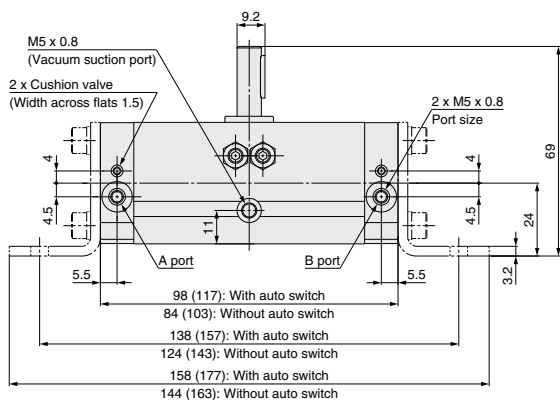
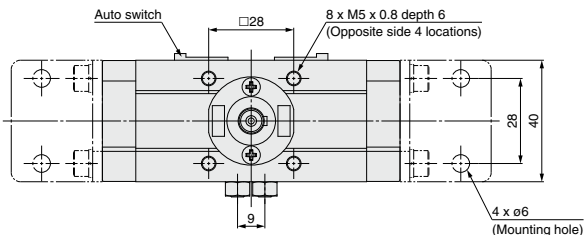
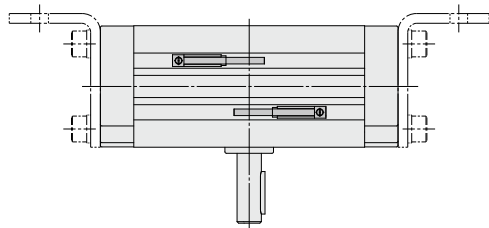

- The dimensions above show pressurization to B port.
 - Drawing shows the auto switch is mounted. (Dimensions with an asterisk mark (*) are not required for actuators without the auto switch.)
 - * () are the dimensions for rotation of 180°.
- Note) A parallel key is included in the same package, (but not assembled).

Dimensions: Basic Type, 11-C□RA1□S50

Size: 50

Single shaft

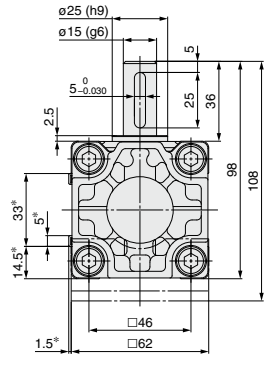
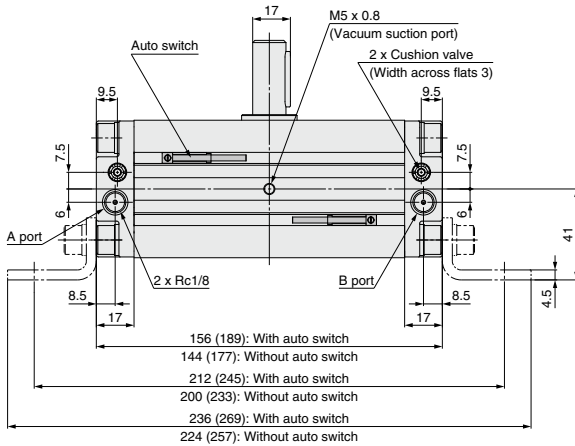
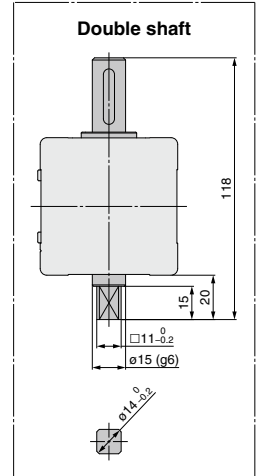
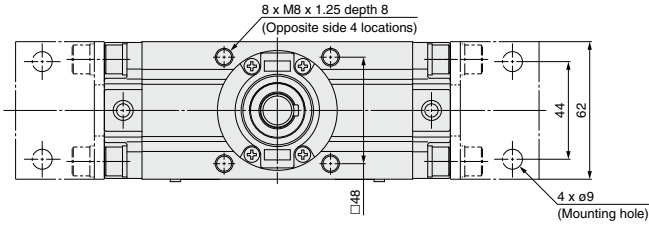

- The dimensions above show pressurization to B port.
 - Drawing shows the auto switch mounted on the port side. (Dimensions with an asterisk mark (*) are not required for actuators without the auto switch, * () are the dimensions for rotation of 180° and 190°.
- Note) A parallel key is included in the same package, (but not assembled).

Directional Control Valves
Air Cylinders
Rotary Actuators
Air Grippers
Air Preparation Equipment
Modular F. R.
Pressure Control Equipment
Fittings & Tubing
Flow Control Equipment
Pressure Switches/ Pressure Sensors