

Series 10-/21-**CQS** 11-/22-

ø12, ø16, ø20, ø25 Compact Cylinder

How to Order

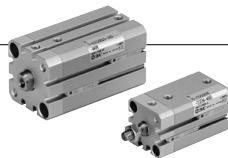

Mounting
B Through-hole, Both ends tapped (Standard)

Bore size (mm)
12, 16, 20, 25

Clean series
10 Relief type
11 Vacuum suction type

Cylinder stroke (mm)
* Refer to the table below for standard strokes.

Number of auto switches

Nil	2 pcs.
S	1 pc.
n	n pcs.

10 - C D Q S B 12 - 5 D - M9B

21 - C D Q S B 12 - 5 D - M9B

With auto switch

Nil	No
D	With auto switch (Built-in magnet)

Copper, fluorine and silicone-free + Low particulate generation

21	Relief type
22	Vacuum suction type

Action

D	Double acting
---	---------------

Auto switch (With auto switch)

Nil	Without auto switch (Built-in magnet cylinder)
-----	--

* For auto switch part numbers, refer to the next page.
* The minimum stroke for auto switch mounting and operating range are the same as standard products.
* Auto switch is packaged together (not assembled).

Rod end thread

Nil	Standard (Rod end female thread)
M	Rod end male thread

Model

	Model	Bore size (mm)	Port size	Relief port	Action	Standard stroke (mm)
Relief type	10-/21-CQSB12	12	M5 x 0.8	M5 x 0.8	Double acting Single rod	5, 10, 15, 20, 25, 30
	10-/21-CQSB16	16				5, 10, 15, 20, 25, 30, 35, 40, 45, 50
	10-/21-CQSB20	20				5, 10, 15, 20, 25, 30
	10-/21-CQSB25	25				5, 10, 15, 20, 25, 30, 35, 40, 45, 50
Vacuum suction type	11-/22-CQSB12	12	M5 x 0.8	M5 x 0.8	Double acting Single rod	5, 10, 15, 20, 25, 30
	11-/22-CQSB16	16				5, 10, 15, 20, 25, 30, 35, 40, 45, 50
	11-/22-CQSB20	20				5, 10, 15, 20, 25, 30
	11-/22-CQSB25	25				5, 10, 15, 20, 25, 30, 35, 40, 45, 50

Specifications

Item	Bore size (mm)
	12/16/20/25
Proof pressure	1.5 MPa
Maximum operating pressure	1.0 MPa
Minimum operating pressure	ø12, ø16: 0.07 MPa, ø20, ø25: 0.05 MPa
Ambient and fluid temperature	Without auto switch : -10°C to 70°C With auto switch : -10°C to 60°C (No freezing)
Cushion	None
Piston speed	30 to 400 mm/s
Stroke length tolerance	+1.0 -0
Mounting	Through-hole, Both ends tapped
Grease	10-/11-: Fluorine grease 21-/22-: Lithium soap based grease
Cleanliness class (ISO class)	10-/21-: Class 4, 11-/22-: Class 3

Suction Flow Rate of Vacuum Suction Type (Reference values)

Size	Suction flow rate L/min (ANR)
12/16/20/25	5

Auto Switch Specifications (Refer to the **WEB catalog** for detailed specifications and auto switches not in the following table.)

Type	Auto switch part no.	Load voltage	Load current range	Indicator light	Application
Reed auto switch	D-A93	24 VDC, 100 VAC	5 to 40 mA, 5 to 20 mA	○	Relay, PLC
Solid state auto switch	2-wire D-M9B	24 VDC (10 to 28 VDC)	2.5 to 40 mA	○	24 VDC Relay, PLC
	3-wire D-M9N, D-M9P	28 VDC or less	40 mA or less	○	IC circuit, Relay, PLC

Refer to page 889 for the applicable auto switch list.

PLC: Programmable Logic Controller

Auto Switch Proper Mounting Position (Detection at Stroke End)

D-A93

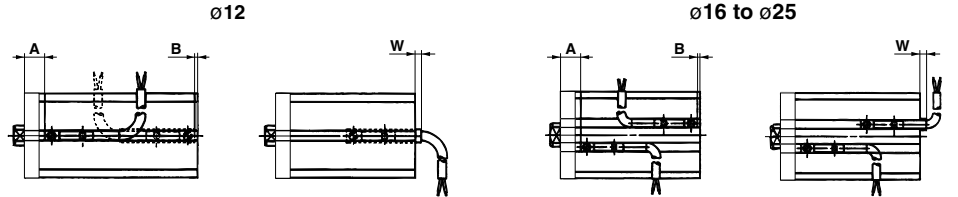

D-M9B/M9N

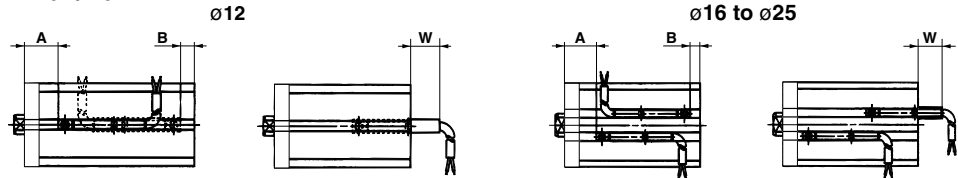

Bore size (mm)	D-A93			D-M9B/M9N/M9P		
	A	B	W	A	B	W
12	11.5	0.5	4	15.5	4.5	5.5
16	12	0	4.5	16	4	6
20	16	3.5	1	20	7.5	2.5
25	17	5.5	-1	21	9.5	0.5

⚠ Specific Product Precautions

Be sure to read this before handling.

Mounting

⚠ Caution

- When a magnetic object comes in close proximity with the cylinder as shown in the right figures (including proximity on one side only), the auto switch operation may become unstable. Consult with SMC in such cases.

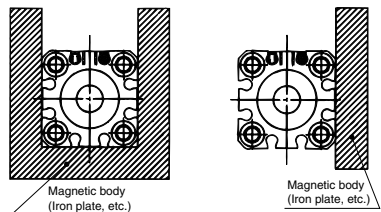

Directional Control Valves
 Air Cylinders
 Rotary Actuators
 Air Grippers
 Air Preparation Equipment
 Modular F. R.
 Pressure Control Equipment
 Fittings & Tubing
 Flow Control Equipment
 Pressure Switches/ Pressure Sensors

Compact Cylinder ¹⁰⁻**CQS/21-****CQS**

Standard: ¹⁰⁻**CQSB12 to 25,** ²¹⁻**CQSB12 to 25**

Ø12

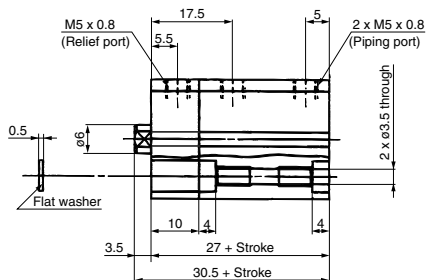
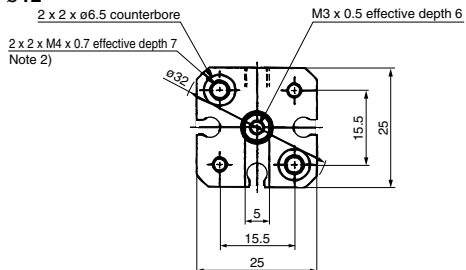

Ø16

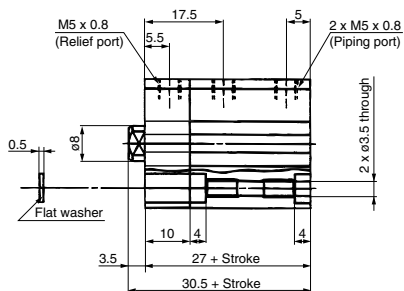
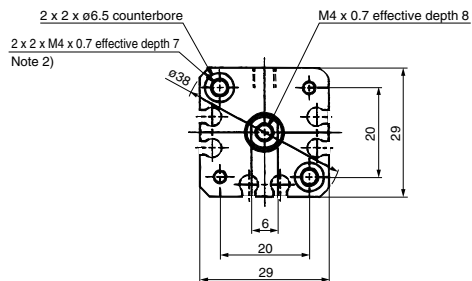

Ø20

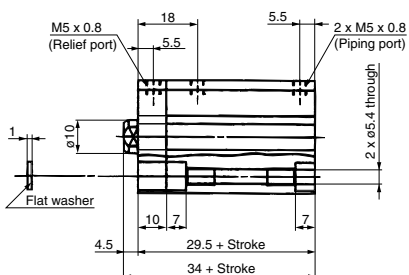
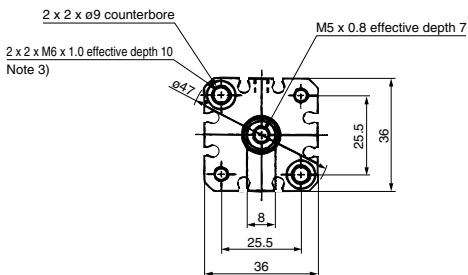

Ø25

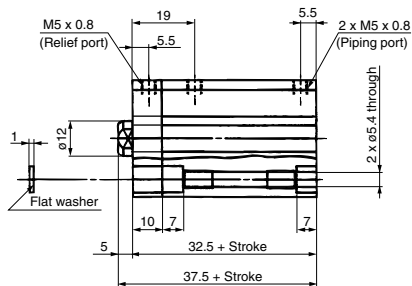
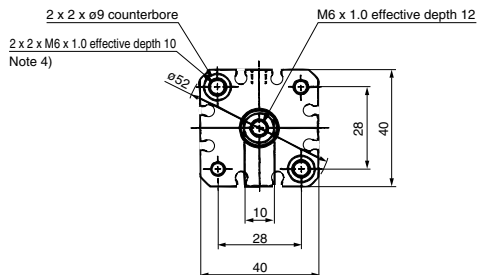

Note 1) Standard strokes available in 5 mm increments.

Note 2) Through-hole in case of 5 mm stroke.

Note 3) Through-hole in case of 5 to 15 mm stroke.

Note 4) Through-hole in case of 5 or 10 mm stroke.

Rod End Male Thread: ¹⁰/₁₁-CQSB12 to 25, ²¹/₂₂-CQSB12 to 25

Ø12

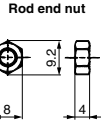
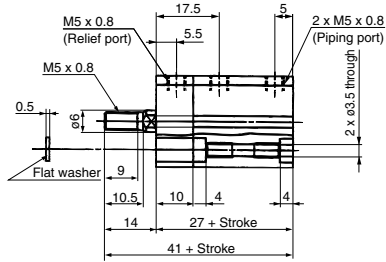
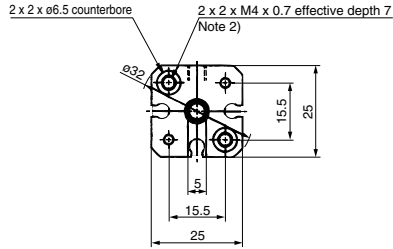

Ø16

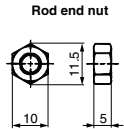
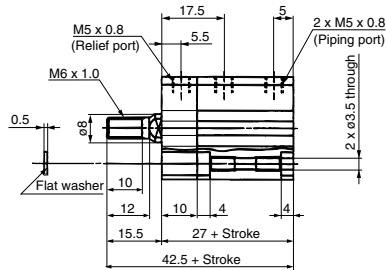
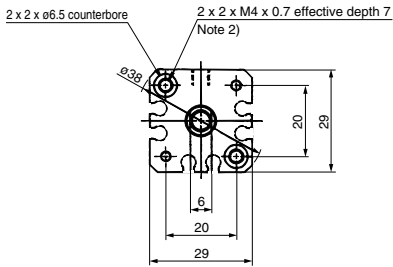

Ø20

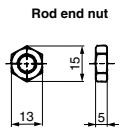
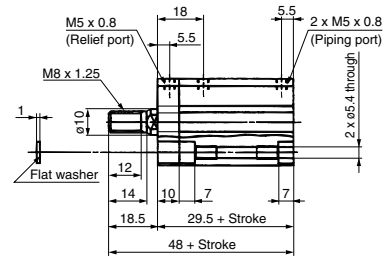
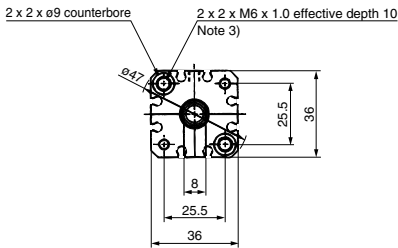

Ø25

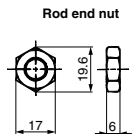
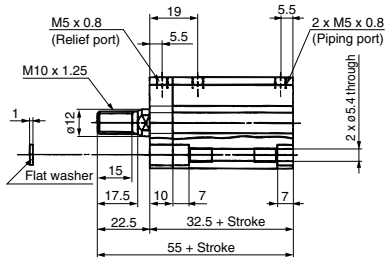
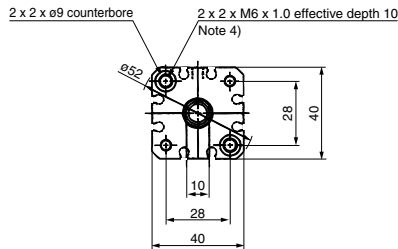

Note 1) Standard strokes available in 5 mm increments.
Note 2) Through-hole in case of 5 mm stroke.
Note 3) Through-hole in case of 5 to 15 mm stroke.
Note 4) Through-hole in case of 5 or 10 mm stroke.

Directional Control Valves

Air Cylinders

Rotary Actuators

Air Grippers

Air Preparation Equipment

Modular F. R.

Pressure Control Equipment

Fittings & Tubing

Flow Control Equipment

Pressure Switches/ Pressure Sensors

Compact Cylinder $\frac{10}{11}$ -CQS/ $\frac{21}{22}$ -CQS

With Auto Switch: $\frac{10}{11}$ -CDQSB12 to 25, $\frac{21}{22}$ -CDQSB12 to 25

Ø12

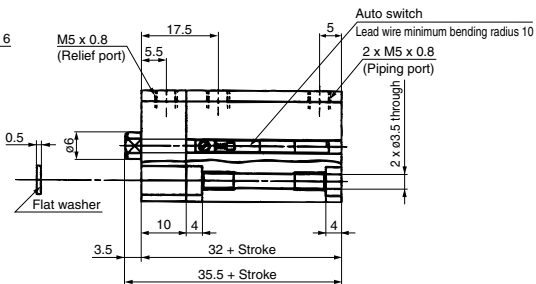
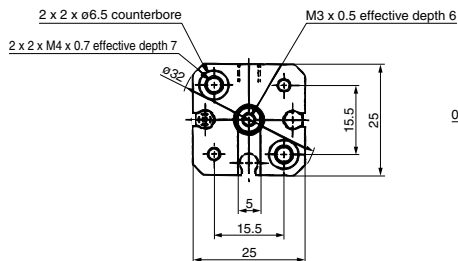

Ø16

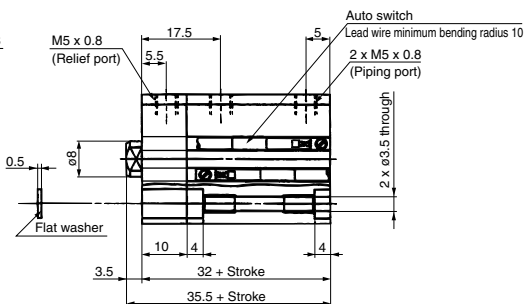
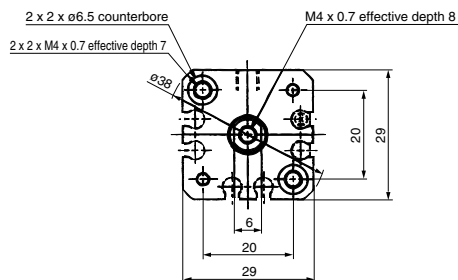

Ø20

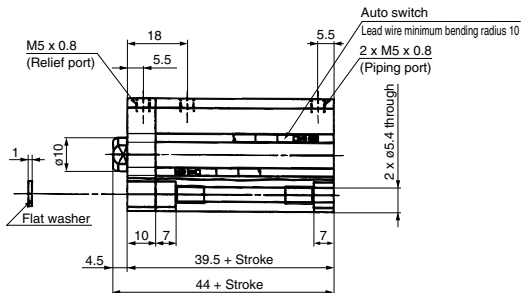
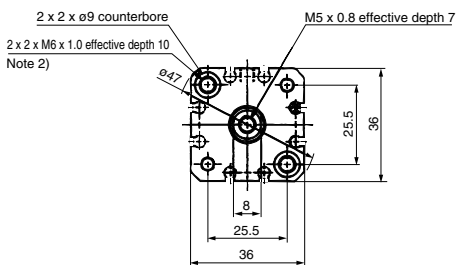

Ø25

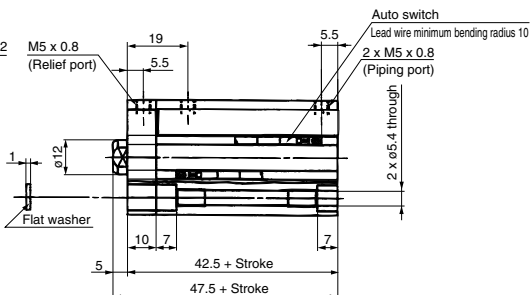
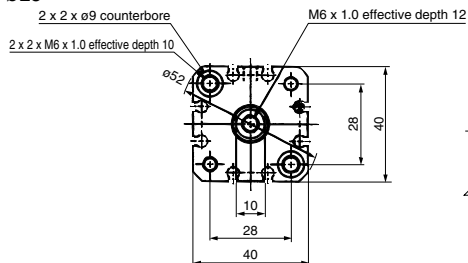

Note 1) Standard strokes available in 5 mm increments.
Note 2) Through-hole in case of 5 mm stroke.

Rod End Male Thread with Auto Switch: 10: CDQSB12 to 25, 21: CDQSB12 to 25

Ø12

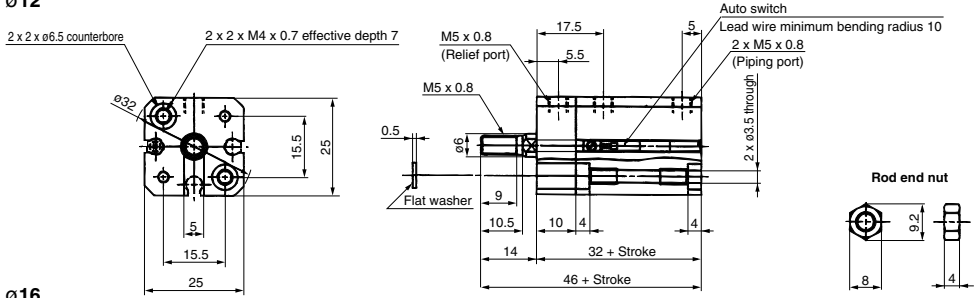

Ø16

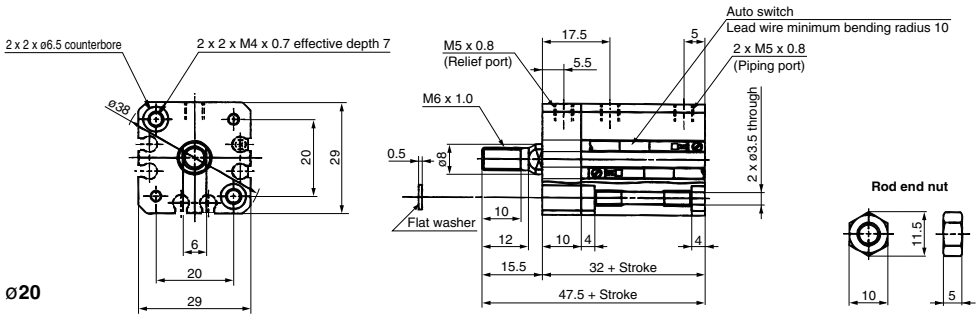

Ø20

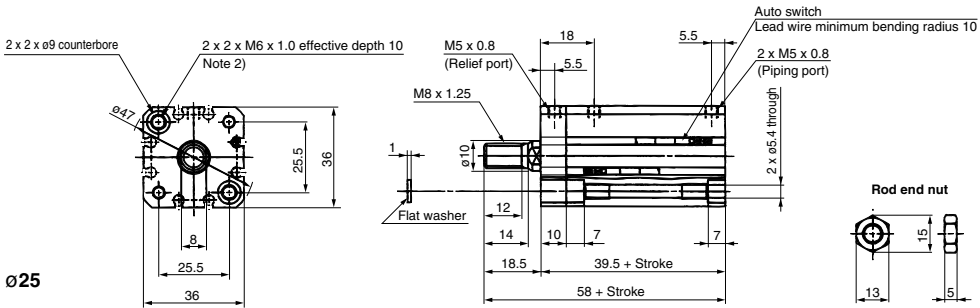

Ø25

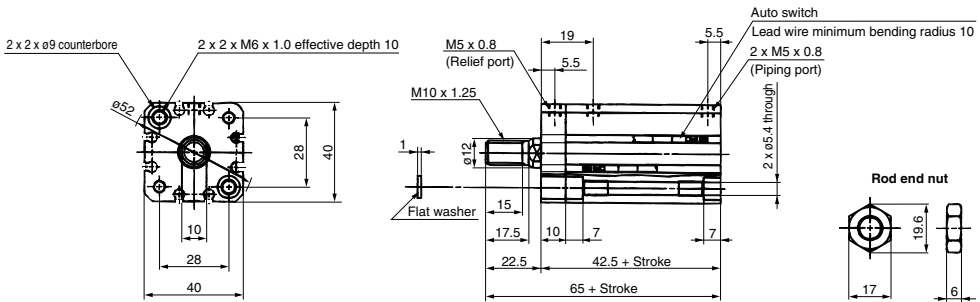

Note 1) Standard strokes available in 5 mm increments.
Note 2) Through-hole in case of 5 mm stroke.

Directional Control Valves
Air Cylinders
Rotary Actuators
Air Grippers
Air Preparation Equipment
Modular F. R.
Pressure Control Equipment
Fittings & Tubing
Flow Control Equipment
Pressure Switches/ Pressure Sensors

Mounting Bolt for CQS

Mounting method: Mounting bolt for through-hole mounting of the CQSB is available as an option.

Refer to the following for ordering procedures.

Order the actual number of bolts that will be used.

Example) CQ-M3 x 35L 2 pcs.

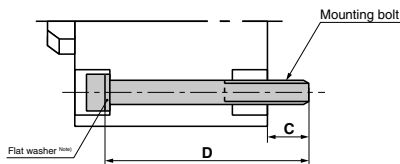

Note) Be sure to use the attached flat washer when mounting a cylinder with through-holes.

Rod side mounting/Without auto switch

Model		C	D	Mounting bolt
10-21-	11-22-	6.5	CQSB12-5D	35 CQ-M3 x 35L
			-10D	40 x 40L
			-15D	45 x 45L
			-20D	50 x 50L
			-25D	55 x 55L
			-30D	60 x 60L
10-21-	11-22-	6.5	CQSB16-5D	35 CQ-M3 x 35L
			-10D	40 x 40L
			-15D	45 x 45L
			-20D	50 x 50L
			-25D	55 x 55L
			-30D	60 x 60L
10-21-	11-22-	6.5	CQSB20-5D	35 CQ-M5 x 35L
			-10D	40 x 40L
			-15D	45 x 45L
			-20D	50 x 50L
			-25D	55 x 55L
			-30D	60 x 60L
			-35D	65 x 65L
			-40D	70 x 70L
			-45D	75 x 75L
			-50D	80 x 80L
10-21-	11-22-	8.5	CQSB25-5D	40 CQ-M5 x 40L
			-10D	45 x 45L
			-15D	50 x 50L
			-20D	55 x 55L
			-25D	60 x 60L
			-30D	65 x 65L
			-35D	70 x 70L
			-40D	75 x 75L
			-45D	80 x 80L
			-50D	85 x 85L

Head side mounting/Without auto switch

Model		C	D	Mounting bolt
10-21-	11-22-	6.5	CQSB12-5D	25 CQ-M3 x 25L
			-10D	30 x 30L
			-15D	35 x 35L
			-20D	40 x 40L
			-25D	45 x 45L
			-30D	50 x 50L
10-21-	11-22-	6.5	CQSB16-5D	25 CQ-M3 x 25L
			-10D	30 x 30L
			-15D	35 x 35L
			-20D	40 x 40L
			-25D	45 x 45L
			-30D	50 x 50L
10-21-	11-22-	6.5	CQSB20-5D	25 CQ-M5 x 25L
			-10D	30 x 30L
			-15D	35 x 35L
			-20D	40 x 40L
			-25D	45 x 45L
			-30D	50 x 50L
			-35D	55 x 55L
			-40D	60 x 60L
			-45D	65 x 65L
			-50D	70 x 70L
10-21-	11-22-	8.5	CQSB25-5D	30 CQ-M5 x 30L
			-10D	35 x 35L
			-15D	40 x 40L
			-20D	45 x 45L
			-25D	50 x 50L
			-30D	55 x 55L
			-35D	60 x 60L
			-40D	65 x 65L
			-45D	70 x 70L
			-50D	75 x 75L

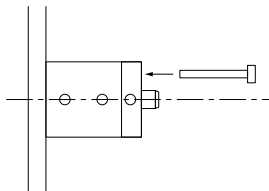
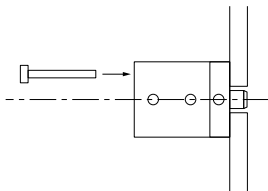

Mounting Bolt for CDQS

Mounting method: Mounting bolt for through-hole mounting of the CDQSB is available as an option. Refer to the following for ordering procedures. Order the actual number of bolts that will be used.
Example) CQ-M3 x 40L 2 pcs.

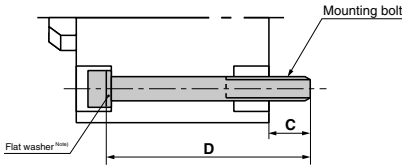

Note) Be sure to use the attached flat washer when mounting a cylinder with through-holes.

Rod side mounting/With auto switch

Model		C	D	Mounting bolt
10-21-	11-22-	6.5	CDQSB12-5D	40 CQ-M3 x 40L
			-10D	45 x 45L
			-15D	50 x 50L
			-20D	55 x 55L
			-25D	60 x 60L
			-30D	65 x 65L
10-21-	11-22-	6.5	CDQSB16-5D	40 CQ-M3 x 40L
			-10D	45 x 45L
			-15D	50 x 50L
			-20D	55 x 55L
			-25D	60 x 60L
			-30D	65 x 65L
10-21-	11-22-	6.5	CDQSB20-5D	45 CQ-M5 x 45L
			-10D	50 x 50L
			-15D	55 x 55L
			-20D	60 x 60L
			-25D	65 x 65L
			-30D	70 x 70L
			-35D	75 x 75L
			-40D	80 x 80L
			-45D	85 x 85L
			-50D	90 x 90L
10-21-	11-22-	8.5	CDQSB25-5D	50 CQ-M5 x 50L
			-10D	55 x 55L
			-15D	60 x 60L
			-20D	65 x 65L
			-25D	70 x 70L
			-30D	75 x 75L
			-35D	80 x 80L
			-40D	85 x 85L
			-45D	90 x 90L
			-50D	95 x 95L

Head side mounting/With auto switch

Model		C	D	Mounting bolt
10-21-	11-22-	6.5	CDQSB12-5D	30 CQ-M3 x 30L
			-10D	35 x 35L
			-15D	40 x 40L
			-20D	45 x 45L
			-25D	50 x 50L
			-30D	55 x 55L
10-21-	11-22-	6.5	CDQSB16-5D	30 CQ-M3 x 30L
			-10D	35 x 35L
			-15D	40 x 40L
			-20D	45 x 45L
			-25D	50 x 50L
			-30D	55 x 55L
10-21-	11-22-	6.5	CDQSB20-5D	35 CQ-M5 x 35L
			-10D	40 x 40L
			-15D	45 x 45L
			-20D	50 x 50L
			-25D	55 x 55L
			-30D	60 x 60L
			-35D	65 x 65L
			-40D	70 x 70L
			-45D	75 x 75L
			-50D	80 x 80L
10-21-	11-22-	8.5	CDQSB25-5D	40 CQ-M5 x 40L
			-10D	45 x 45L
			-15D	50 x 50L
			-20D	55 x 55L
			-25D	60 x 60L
			-30D	65 x 65L
			-35D	70 x 70L
			-40D	75 x 75L
			-45D	80 x 80L
			-50D	85 x 85L

