

Series 10-V100

Rubber seal 3 port direct operated solenoid valve

Specifications

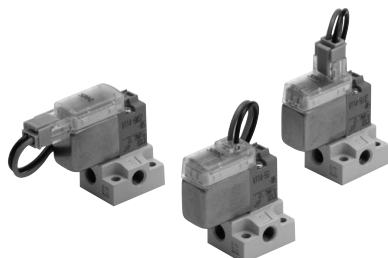

Fluid	Air
Ambient and fluid temperature (°C)	-10 to 50 (With no freezing. Refer to page 714.)
Response time (DC) ms ^{Note 1)}	ON: 5 or less, OFF: 4 or less
Max. operating frequency (Hz)	20
Manual override	Non-locking push type, push-turn locking slotted type
Lubrication	Not required
Mounting position	Unrestricted
Impact / vibration resistance (m/s ²) ^{Note 2)}	150/30
Enclosure	Dust tight



Note 1) Based on dynamic performance test, JIS B 8374-1981 (Standard type :Coil temperature 20°C, at rated voltage, without surge voltage suppressor)

Note 2) Impact resistance: No malfunction occurred when it is tested with a drop tester in the axial direction and at the right angles to the main valve and armature in both energized and de-energized states every once for each condition. (Initial value)

Vibration resistance: No malfunction occurred in one sweep between 45 and 2000Hz. Test was performed in the axial direction and at the right angles to the main valve and armature in both energized and de-energized states. (Initial value)

Solenoid specifications

Series	10-V114/V124	10-V114A/V124A	
Electrical entry	Grommet (G)/(H), L plug connector (L) M plug connector (M)		
Coil rated voltage V	DC	24, 12, 6, 5, 3	
	AC ^{50/60} Hz	100, 110, 200, 220	
Allowable voltage fluctuation	-10 to 10%*		
Power consumption (W)	DC	Standard: 0.35 (With indicator light: 0.4) With power saving circuit: 0.1 ^{Note)} [Starting 0.4, Holding 0.1]	
	AC	1 W (With indicator light: 1.1)	
Apparent power (VA)	AC	100V	0.78 (With indicator light: 0.81)
		110V	0.86 (With indicator light: 0.89)
		[115V]	0.94 (With indicator light: 0.97)
		200V	1.18 (With indicator light: 1.22)
		220V	1.30 (With indicator light: 1.34)
[230V]	1.42 (With indicator light: 1.46)]		
Surge voltage suppressor	Refer to page 647.		
Indicator light	LED		

Symbol

10-V114 (A)

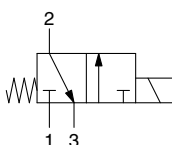

10-V124 (A)

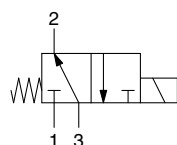

* In common between 110VAC and 115VAC, and between 220VAC and 230VAC.

* For 115VAC and 230VAC, the allowable voltage fluctuation will be -15% to 5% of rated voltage.

* The voltage drop will occur due to the internal circuit of S, Z and T types (with energy saving circuits).

Allowable voltage fluctuations should be within the range below.

S and Z types 24 VDC: -7% to +10%

12 VDC: -4% to +10%

T type 24 VDC: -8% to +10%

12 VDC: -6% to +10%

* Select the DC standard type or the power saving circuit type when the valve is continuously energized for long periods of time.

Note) Refer to page 647 for details.

Model

Valve model	Type of actuation	Type	Operating pressure range (MPa)	Vacuum specification (MPa)		Port size		Weight (g) ^{Note 2)}	
				Port 1	Port 3	Ports 1, 3	Port 2	Grommet type	L/M plug connector
10-V114	N.C.	Standard	0 to 0.7	-100kPa to 0.6	-100kPa to 0	M5 x 0.8	M5 x 0.8	10-V1□4: 13(27) 10-V1□4A: 16(30)	10-V1□4: 12(26) 10-V1□4A: 15(29)
10-V114A	N.C.	Large flow capacity	0 to 0.7	-100kPa to 0.6	-100kPa to 0	M5 x 0.8	M5 x 0.8		
10-V124 ^{Note 1)}	N.O.	Standard	0 to 0.7	-100kPa to 0	-100kPa to 0.6	M5 x 0.8	M5 x 0.8		
10-V124A ^{Note 1)}	N.O.	Large flow capacity	0 to 0.7	-100kPa to 0	-100kPa to 0.6	M5 x 0.8	M5 x 0.8		

Valve model	Flow characteristics					
	1→2 [3→2 ^{Note 3)}			2→3 [2→1 ^{Note 3)}		
	C[dm ³ /(s·bar)]	b	Cv	C[dm ³ /(s·bar)]	b	Cv
10-V114	0.037	0.11	0.008	0.054	0.35	0.015
10-V114A	0.076	0.07	0.016	0.099	0.23	0.024
10-V124 ^{Note 1)}	0.054	0.35	0.015	0.037	0.11	0.008
10-V124A ^{Note 1)}	0.099	0.23	0.024	0.076	0.07	0.016

-  Note 1) 10-V124 and 10-V124A: Supply pressure to port 3 and exhaust from port 1.
- Note 2) (): With sub-plate
- Note 3) For 10-V124(A)

Air cylinder

Rotary actuator

Air gripper

Directional control valve

Flow control equipment

Filter, Pressure control equipment

Fittings & Tubing

Air preparation equipment

Pressure switch

Clean gas filter

How to Order

Standard type

Base mounted 10-V1 1 4 5 M

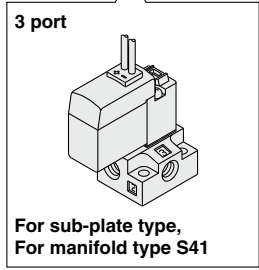

● Clean series

Type of actuation

1	Normally closed
2	Normally open

Coil specifications

Nil	0.35W
T	0.1 W (with power saving circuit) (24 VDC and 12 VDC only)

* All types with power saving circuit are with light/surge voltage suppressor.

Rated voltage

For DC		CE-compliant
5	24 VDC	●
6	12 VDC	●
V	6 VDC	●
S	5 VDC	●
R	3 VDC	●
For AC (50/60Hz)		CE-compliant
1	100 VAC	—
2	200 VAC	—
3	110 VAC [115 VAC]	—
4	220 VAC [230 VAC]	—

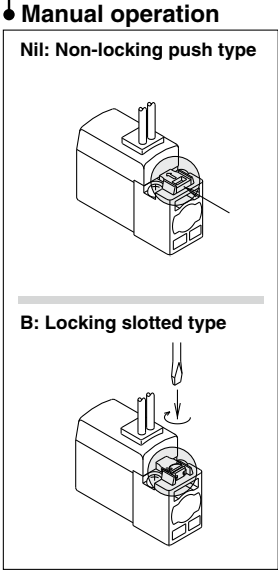
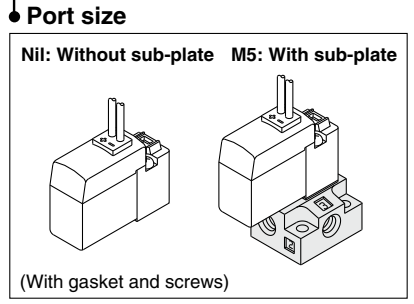

Electrical entry

24, 12, 6, 5, 3 VDC / 100, 110, 200, 220 VAC

Grommet	L plug connector	M plug connector	
G: Lead wire length 300 mm	L: With lead wire (Lead wire length 300 mm)	M: With lead wire (Lead wire length 300 mm)	MN: Without lead wire
H: Lead wire length 600 mm	LN: Without lead wire	LO: Without connector	MO: Without connector

● Light/ Surge voltage suppressor

Nil	Without light/surge voltage suppressor	DC, AC specifications
S	With surge voltage suppressor	DC specifications
Z	With light/surge voltage suppressor	DC, AC specifications
R	With surge voltage suppressor (Non-polar type)	DC specifications
U	With light/surge voltage suppressor (Non-polar type)	

* Power saving circuit is only available in the "Z" type.

* "LN", "MN" type: with 2 sockets.

How to Order



Large flow type

Base mounted 10-V1 1 4 A-5 M

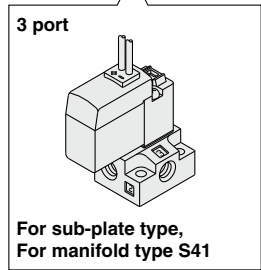

• Clean series

• Type of actuation

1	Normally closed
2	Normally open

• Large flow type

• Rated voltage

	For DC	CE-compliant
5	24 VDC	●
6	12 VDC	●
V	6 VDC	●
S	5 VDC	●
R	3 VDC	●

• Port size

Nil: Without sub-plate M5: With sub-plate

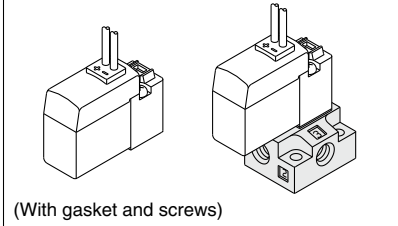

• Manual override

Nil: Non-locking push type

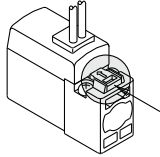

B: Locking slotted type

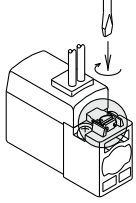

• Light/surge voltage suppressor

Nil	Without light/surge voltage suppressor	For DC
R	With surge voltage suppressor	
U	With light/surge voltage suppressor	

• Electrical entry

	24, 12, 6, 5, 3 VDC		
Grommet	L plug connector	M plug connector	
G: Lead wire Length 300 mm	L: With lead wire (Length 300 mm)	M: With lead wire (Length 300 mm)	MN: Without lead wire
H: Lead wire Length 600 mm	LN: Without lead wire	LO: Without connector	MO: Without connector

* "LN", "MN" types: with 2 sockets.

Air cylinder
Rotary actuator
Air gripper
Directional control valve
Flow control equipment
Filter, Pressure control equipment
Fittings & Tubing
Air preparation equipment
Pressure switch
Clean gas filter

3 port solenoid valve 10-V100

Base mounted (with sub-plate)

Note) []: AC
< >: Large flow type (A)

Grommet (G)/(H): 10-V1¹/₂4(A)-□^G/_H□□-M5

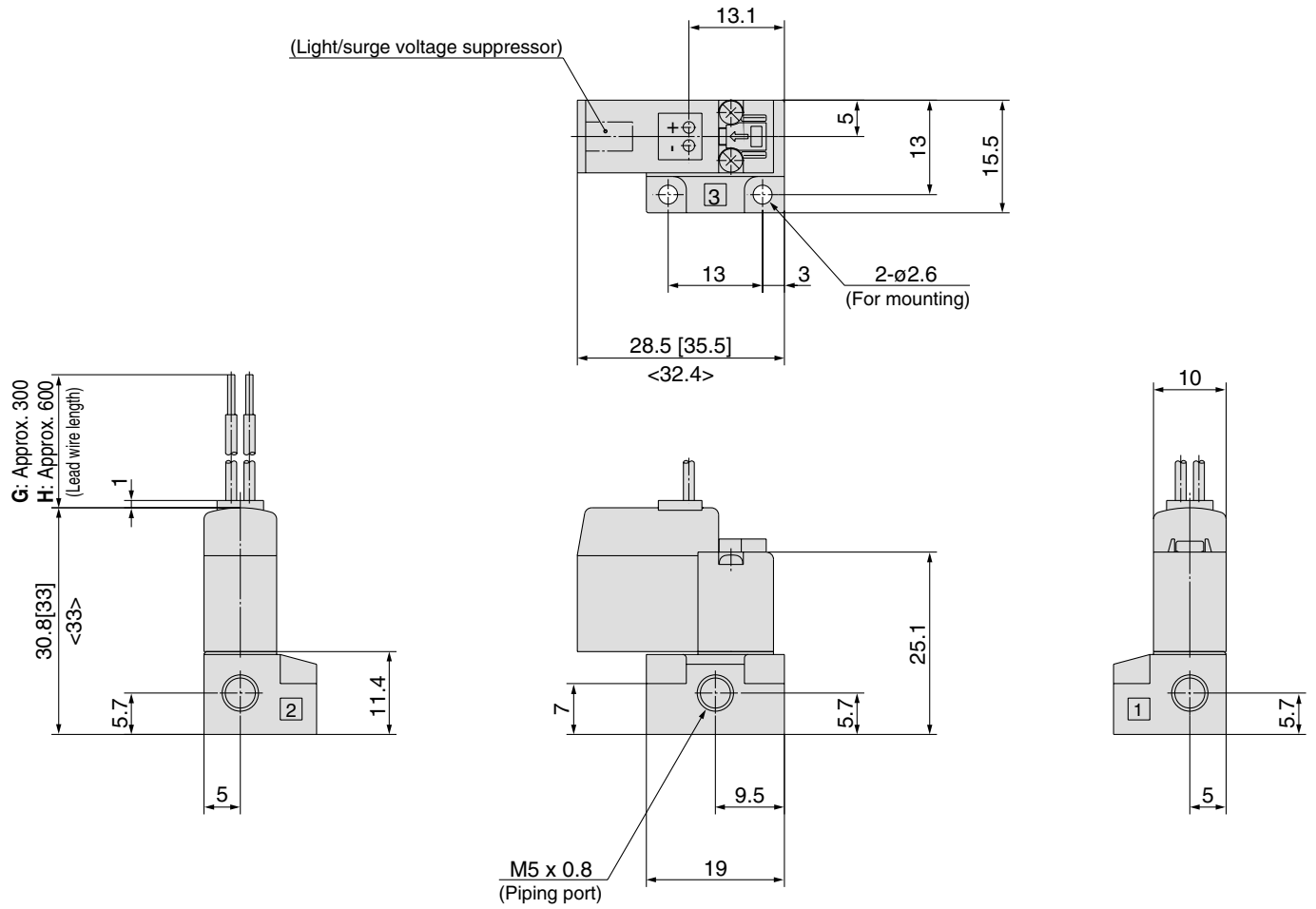

L plug connector (L): 10-V1¹/₂4(A)-□L□□-M5

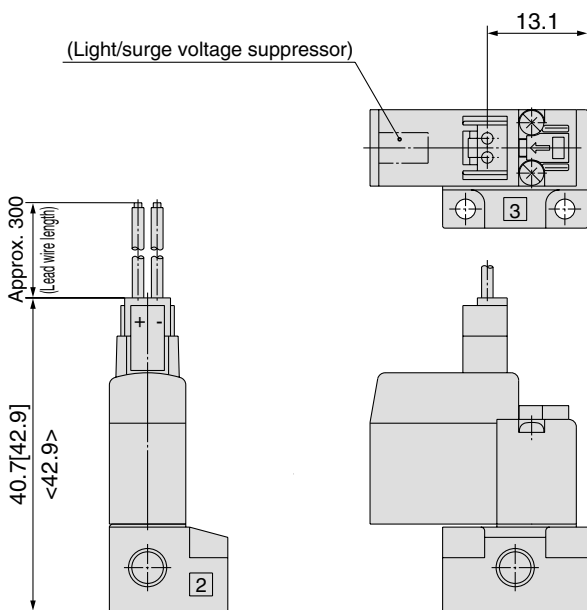

M plug connector (M): 10-V1¹/₂4(A)-□M□□-M5

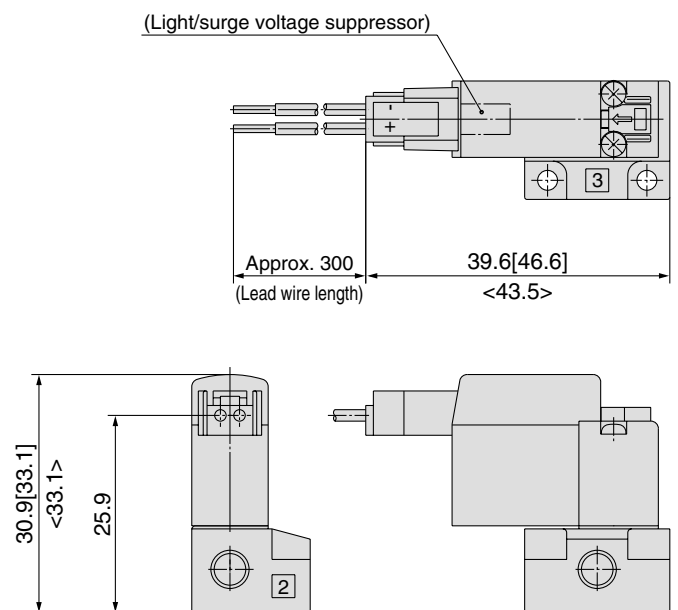

* Other dimensions are same as grommet style.

* Other dimensions are same as grommet style.

Series 10-V100

3 port solenoid valve Manifold specifications

Manifold specifications

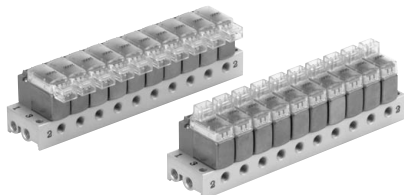

Model		S41 type
Manifold		Single base / B mount
P (SUP), R (EXH)		Common SUP / Common EXH
Stations		2 to 20 stations
Output port Porting specifications	Location	Base
	Direction	Side
Port size		1, 2, 3 port
		M5 x 0.8

Note 1) 10-V114(A) and 10-V124(A) cannot be mounted on the same manifold.
 Note 2) For 10-V124(A), supply pressure to port 3 and exhaust from port 1.

Flow characteristics Note 1)

Manifold		Port size	Flow characteristics					
			1→2 [3→2 <small>Note 2)</small>]			2→3 [2→1 <small>Note 2)</small>]		
		1, 2, 3 port	C[dm ³ /(s·bar)]	b	Cv	C[dm ³ /(s·bar)]	b	Cv
10-VV100-S41 type	10-V114	M5 x 0.8	0.032	0.13	0.007	0.050	0.26	0.012
	10-V114A		0.070	0.10	0.016	0.085	0.16	0.020
	10-V124		0.050	0.26	0.012	0.032	0.13	0.007
	10-V124A		0.085	0.16	0.020	0.070	0.10	0.016

Note 1) Values when manifold base (5 stations) is mounted.
 Note 2) For 10-V124(A)

How to Order Valve Manifold Assembly

Ordering example

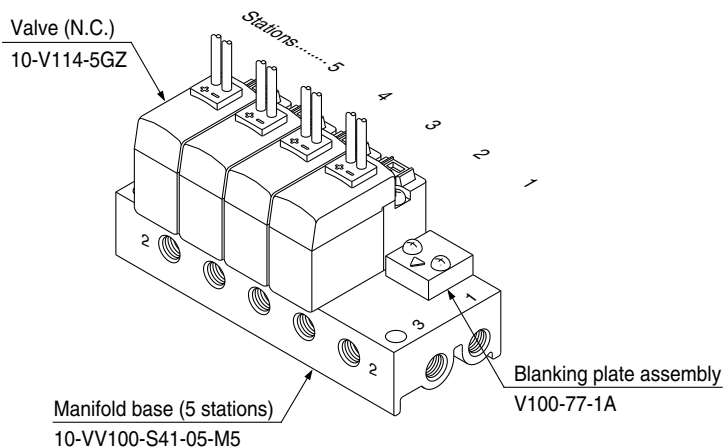

10-VV100-S41-05-M5.....1 set (S41 type 5 station manifold part no.)
 * **V100-77-1A**.....1 set (blanking plate assembly part no.)
 * **10-V114-5GZ**.....4 sets (valve)
 ↳The asterisk denotes the symbol for assembly. Prefix it to the part nos. of the solenoid valve, etc.

Indicate part numbers of valve and option beneath the manifold part no.

Air cylinder
 Rotary actuator
 Air gripper
 Directional control valve
 Flow control equipment
 Filter, Pressure control equipment
 Fittings & Tubing
 Air preparation equipment
 Pressure switch
 Clean gas filter

Manifold specifications 10-V100

Common SUP / Common EXH

S41 type

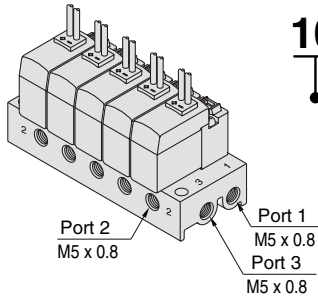

How to Order

10 - VV100 - S41 - 05 - M5

● Clean series

Stations ●	
02	2 stations
⋮	⋮
20	20 stations

● 2 port size

M5	M5 x 0.8
----	----------

Applicable solenoid valve ^{Note)}

10-V114-□□□□

10-V114A-□□□□

10-V124-□□□□

10-V124A-□□□□

Applicable blanking plate assembly
V100-77-1A



Note) 10-V114(A) and 10-V124(A) cannot be mounted on the same manifold.

(Manifold option)

Blanking plate assembly

Part no: V100-77-1A

Place notch mark on the blanking plate to 2 port side when assembling.

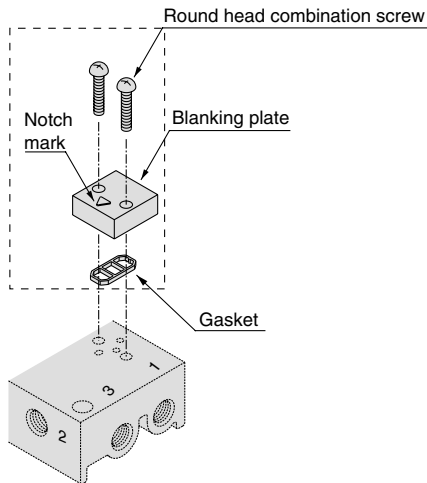

Base

- Sub-plate
- 10-VV100-S41 type manifold base

Type S41 manifold: Side ported / 10-VV100-S41-**Stations**-M5

Note) []: AC
< >: For large flow type (A)

Grommet (G), (H)

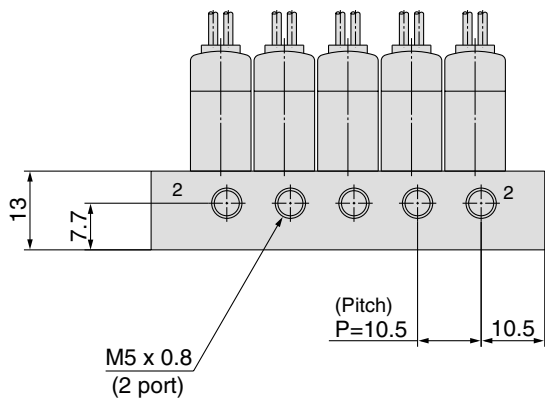
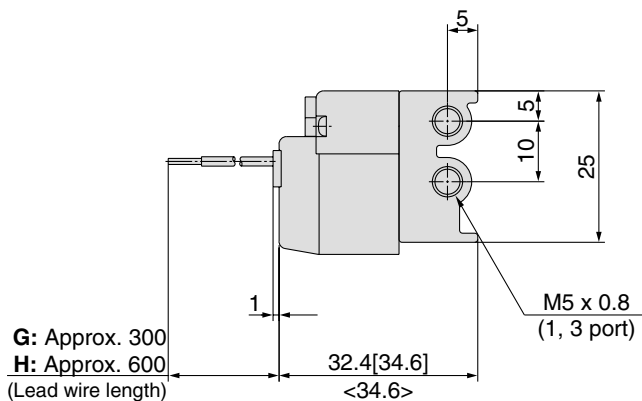
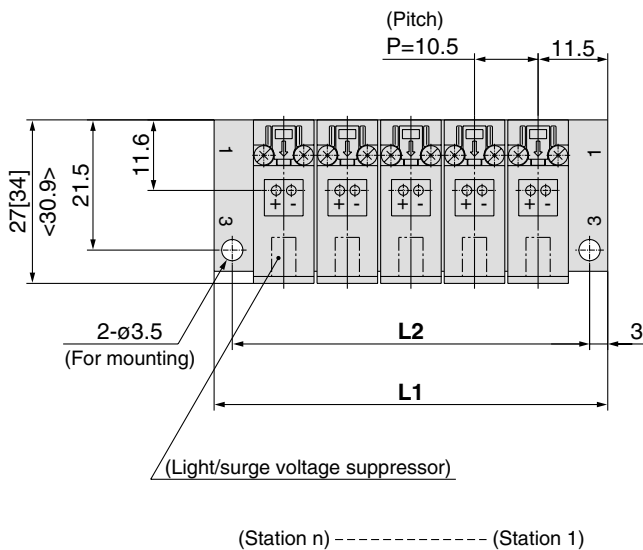

L plug connector (L)

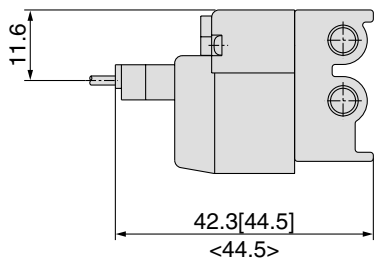

* Other dimensions are same as grommet style.

M plug connector (M)

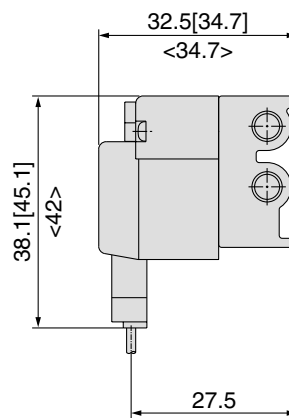

* Other dimensions are same as grommet style.

Stations	2 stations	3	4	5	6	7	8	9	10	11	12	13	14	15	16	17	18	19	20 stations
L1	33.5	44	54.5	65	75.5	86	96.5	107	117.5	128	138.5	149	159.5	170	180.5	191	201.5	212	222.5
L2	27.5	38	48.5	59	69.5	80	90.5	101	111.5	122	132.5	143	153.5	164	174.5	185	195.5	206	216.5

Air cylinder
Rotary actuator
Air gripper
Directional control valve
Flow control equipment
Filter, Pressure control equipment
Fittings & Tubing
Air preparation equipment
Pressure switch
Clean gas filter



Series 10-V100

Specific Product Precautions 1

Be sure to read before handling.

Warning

Manual override operation

Since connected equipment will be actuated when the manual override is operated, first confirm that conditions are safe.

Non-locking push type [Standard]

Press in the direction of the arrow.

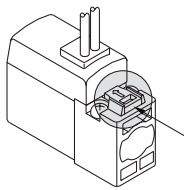

Locking slotted type [B]

Turn in the direction of the arrow.

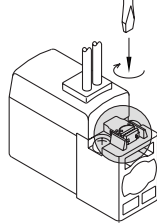

Caution

When operating with a screwdriver, turn it gently using a watchmaker's screwdriver.

[Torque: Less than 0.1 N·m]

Caution

How to use plug connector

1. Attaching and detaching connectors

- To attach a connector, hold the lever and connector unit between your fingers and insert straight onto the pins of the solenoid valve so that the lever's pawl is pushed into the groove and locks.
- To detach a connector, remove the pawl from the groove by pushing the lever downward with your thumb, and pull the connector straight out.

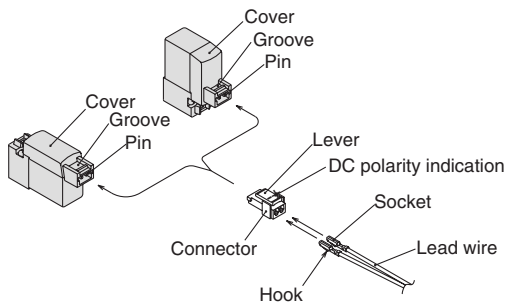

2. Crimping of lead wires and sockets

Strip 3.2 to 3.7 mm at the end of the lead wires, insert the ends of the core wires evenly into the sockets, and then crimp with a crimping tool. When this is done, take care that the coverings of the lead wires do not enter the core wire crimping area.

Use special tool when crimping. (For the crimping tool, please consult with SMC.)

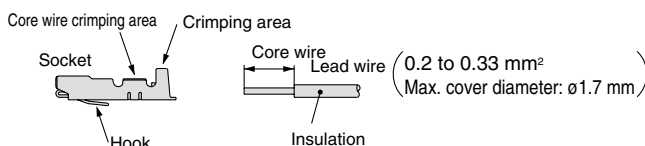

Caution

How to use plug connector

3. Attaching and detaching sockets with lead wires

• Attaching

Insert the sockets into the square holes of the connector (with ⊕ and ⊖ indication), and continue to push the sockets all the way in until they lock by hooking into the seats in the connector. (When they are pushed in, their hooks open and they are locked automatically.) Then confirm that they are locked by pulling lightly on the lead wires.

• Detaching

To detach a socket from a connector, pull out the lead wire while pressing the socket's hook with a stick having a thin tip (approx. 1 mm). If the socket will be used again, first spread the hook outward.

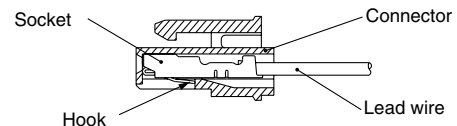

Plug connector lead wire length

Standard length is 300 mm, however, the following lengths are also available.

How to Order Connector Assembly

For DC : **SY100-30-4A**

For 100 VAC : **SY100-30-1A**

For 200 VAC : **SY100-30-2A**

For other voltages of AC : **SY100-30-3A**

Without lead wire : **SY100-30-A**

(with connector and 2 pcs. of sockets only)

How to Order

Indicate part numbers of the valve without connector and the required connector assembly separately.

<Example> Lead wire length 2000 mm

For DC
10-V114-5LO
SY100-30-4A-20

For AC
10-V114A-1LO
SY100-30-1A-20

Lead wire length

Nil	300mm
6	600mm
10	1000mm
15	1500mm
20	2000mm
25	2500mm
30	3000mm
50	5000mm



Series 10-V100

Specific Product Precautions 2

Be sure to read before handling.

Surge voltage suppressor

(For DC)

Grommet, L/M plug connector

Standard type (with polarity)

With surge voltage suppressor (□S)

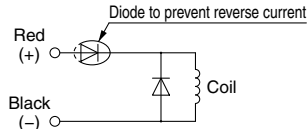
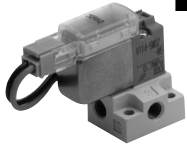

With light/surge voltage suppressor (□Z)

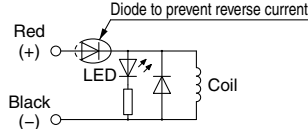

Non-polar type

With surge voltage suppressor (□R)

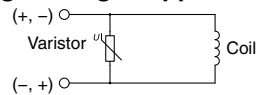

With light/surge voltage suppressor (□U)

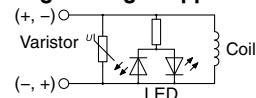

- Please connect correctly the lead wires to + (positive) and - (negative) indications on the connector.
- For DC voltages other than 12 and 24 VDC, use caution not to connect in reverse due to the absence of a diode to prevent reverse current. (Wrong polarity will cause trouble.)
- Solenoids, whose lead wires have been pre-wired: positive side red and negative side black.

With power saving circuit

Power consumption is reduced by approximately 75% compared with the standard product by eliminating the need for electrical current for holding. (Effective after more than 62ms energized and 24 VDC rated voltage applied.)

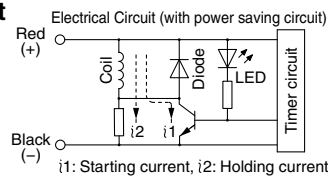

Working principle

The electrical circuit as shown above, allows reduced holding current consumption and measures power saving. Refer to electric waveform on the right.

- When a power saving circuit is installed, a diode to prevent reverse current is not provided. Therefore, use caution not to connect in reverse.

<For AC>

Grommet, L / M plug connectors

With indicator light (□Z)

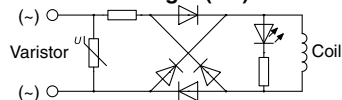

Caution

In the case of ZNR surge voltage suppressor, take note the surge voltage to be suppressed at controller side as there will be a residual voltage according to the protective element and rated voltage. Moreover, the residual voltage of the diode is approximately 1V.

Connector assembly with cover

Connector assembly with protective cover enhances dust protection

- Effective in preventing possible short circuit problems due to contaminants in contact with connector section
- Cover material is chloroprene rubber which has excellent weatherability and electric insulation properties. However, be careful not to allow contact with cutting oil, etc.
- Round cord provides neat appearance.

How to Order

SY100 - 68 - A - □

Lead wire length (L)

Lead wire length (L)	Lead wire length (mm)
Nil	300mm
6	600mm
10	1000mm
15	1500mm
20	2000mm
25	2500mm
30	3000mm
50	5000mm

Connector assembly with cover / Dimensions

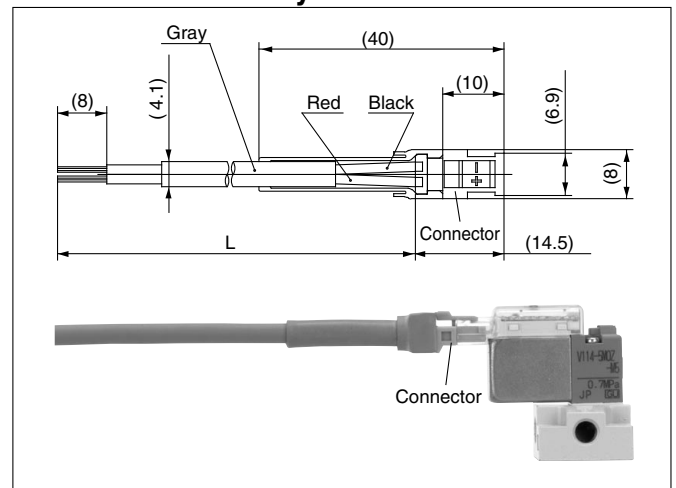

How to Order

Specify the part numbers of the solenoid valve without connector together with the part number of the connector assembly with protective cover.

<Example> Lead wire length 2000 mm

10-V114-5LOZ-M5

SY100-68-A-20

<Example 2 >Lead wire length 300 mm (Standard)

10-V114-5LPZ-M5

□ Symbol of connector assembly with protective cover

- * No part numbers of connector assembly with cover are needed to be indicated in this case.