

Servo directional control valve of 4-way design

RA 29583-VH1-100-B1/05.12
Replaces: 05.10

Type 4WS2EM...VH1...-100

Nominal size 10
Unit series 5X
Maximum working pressure 315 bar
Maximum flow rate 180 l/min



For potentially explosive atmospheres

Part I Technical Data Sheet



Information on explosion protection:

Ranges of application in accordance with Article 505, NEC®

- IS Class I, Zone 0, AEx ia IIC T4
- NI Class I, Zone 2
- Ambient temperature range $-20\text{ °C} \leq T_a \leq +60\text{ °C}$

What you need to know about these Operating Instructions

These Operating Instructions apply to the explosion-proof version of Rexroth valves, and consist of the following three parts:

- | | | |
|----------|---------------------------------------------------|------------------------------|
| Part I | Technical Data Sheet RA 29583-VH1-100-B1 | } RA 29583-VH1-100-B0 |
| Part II | Product-specific Instructions RA 29583-VH1-100-B2 | |
| Part III | Control drawing RA 29583-VH1-100-B3 | |

You can find further information on the correct handling of Rexroth hydraulic products in our publication "General product information for hydraulic products", RE 07008.

Overview of Contents

Contents	Page
Features	2
Ordering data and scope of delivery	3
Symbol	3
Function, sectional diagram	4
Technical data	5 and 6
Information on explosion protection	6
External trigger electronics	6
Plug-in connector	7
Electrical connection	7
Characteristic curves	8 to 11
Unit dimensions	12
Flushing plate	13

Features

- Servo directional control valve for proper use in potentially explosive atmospheres of Zone 0
- Valve for closed-loop position, force and speed control
- 2-Stage servo valve with mechanical feedback
- 1st stage in the form of flapper nozzle amplifier
- For subplate mounting,
Mounting hole configuration to
ISO 4401-05-05-0-05 with ports X and Y.
Subplates, see page 12
- Dry servo motor, no contamination of solenoid gaps by pressure fluid
- Non-wearing spool return element
- Actuation:
External trigger electronics in modular form, additional safety barriers (order separately), see Page 6
- Valve is calibrated and tested
- Internal/external control oil supply and return individually orderable
- Spool with flow force compensation
- Control sleeve permanently centered, therefore reducing sensitivity to temperature and pressure
- Pressure chamber gaps on control sleeve sealed, no wear to O-rings
- Filter for 1st stage freely accessible from the outside

Ordering data and scope of delivery

4WS2E	M	10-5X/	B	11	VH1	K31	V-100
Electrically operated 2-stage servo valve, 4-way version for external = 4WS2E trigger electronics	Mechanical feedback = M	Nominal size 10 = 10 Unit series 50 to 59 (50 to 59: installation and connection dimensions unchanged) = 5X		Valves for external trigger electronics: Coil No. 11 (30 mA/85 Ω per coil) ²⁾ = 11		K31 = with plug to EN175201-804 Plug-in connector – order separately see Page 7	V-100 = Special numbers ⁶⁾ FKM seals ⁶⁾ suitable for mineral oil (HL, HLP) to DIN 51524 Spool overlap ⁵⁾ C = 3 ... 5 % positive D = 0 ... 0,5 % positive E = 0 ... 0,5 % negative Electrical connection K31 = with plug to EN175201-804 Plug-in connector – order separately see Page 7 Supply pressure range to 1st stage ⁴⁾ 210 = 10 ... 210 bar 315 = 10 ... 315 bar Control oil supply and discharge ³⁾ – = External supply, external return E = Internal supply, external return T = External supply, internal return ET = Internals supply, internal return (ET = Standard version)
Nominal flow ¹⁾							
5 l/min = 5							
10 l/min = 10							
20 l/min = 20							
30 l/min = 30							
45 l/min = 45							
60 l/min = 60							
75 l/min = 75							
90 l/min = 90							
Included in scope of delivery:							
– Valve operating instructions							
– Valve fastening screws							
				VH1 = Valve in explosion-proof design For details, see information on explosion protection, Page 6			

1) Nominal flow rate

The nominal flow is based on a 100 % setpoint signal at a valve pressure drop of 70 bar (35 bar per metering edge). The flow can be affected by other values. A possible nominal flow tolerance of ± 10 % (see flow signal function on page 8) must be taken into consideration.

2) Electrical triggering data

The control signal must be generated by a current-regulated output stage with superimposed dither signal. For trigger electronics (servo amplifiers), see page 6.

3) Control oil

The pilot pressure should be kept as constant as possible. Therefore, external pilot control via port X can be advantageous. The valve may be operated with higher pressure at X than at P, to increase the dynamics.

Note:

Ports X and Y are also subject to pressure when the supply and return of control oil are “internal”.

4) Supply pressure range

The system pressure should be kept as constant as possible. Pilot pressure range: 10 ... 210 bar or 10 ... 315 bar. With regard to the dynamics, the dependence on the frequency response must be taken into account within the permitted pressure range.

5) Spool overlap

The spool overlap is stated in % of the control spool stroke.

6) Non-standard version number “100”

When not actuated (power off), channel P → B and A → T are open 10 % of the nominal flow.

Symbol

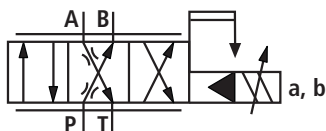

Function, sectional diagram

4WS2EM...VH1...-100

Valves of this type are electrically operated, 2-stage servo directional control valves with a mounting hole configuration to ISO 4401-05-05-0-05. They are predominantly employed for closed-loop position, force and speed control.

These valves consist of an electro-mechanical converter (torque motor) (1), a hydraulic amplifier (flapper nozzle principle) (2) and a control spool (3) in a sleeve (2nd stage), which is connected to the torque motor via a mechanical feedback.

An electrical input signal at the coils (4) of the torque motor causes a permanent magnet to generate a force that acts on the armature (5) and, acting by means of a torque tube (6), this force generates a torque. This torque then moves the flapper plate (7) - which is connected to the torque tube (6) by a rod - out of its central position between the two control orifices (8), resulting in a pressure drop at the end faces of the control spool. This pressure drop causes the position of the spool to change, so that the pressure port is connected to one consumer port and, at the same time, the other consumer port is connected to the return port. In this special version "100" the valve is trimmed about 10% from P → B and A → T.

The control spool is connected to the flapper plate or the torque motor by a feedback spring (mechanical feedback) (9). The position of the spool continues to change until the return torque through the feedback spring and the electro-magnetic torque of the torque motor reach a state of equilibrium, and the pressure drop at the flapper nozzle system becomes zero.

In this way, the stroke of the control spool and thus the flow of the servo valve are closed-loop-controlled proportionately to the electrical input signal. At the same time, it should be noted that the flow is dependent on the valve pressure drop.

External trigger electronics (order separately)

The valve is actuated by external trigger electronics (a servo amplifier), which amplifies an analog input signal (setpoint) so that the controlled-current output signal is capable of driving the servo valve.

Type 4WS2EM...VH1...-100

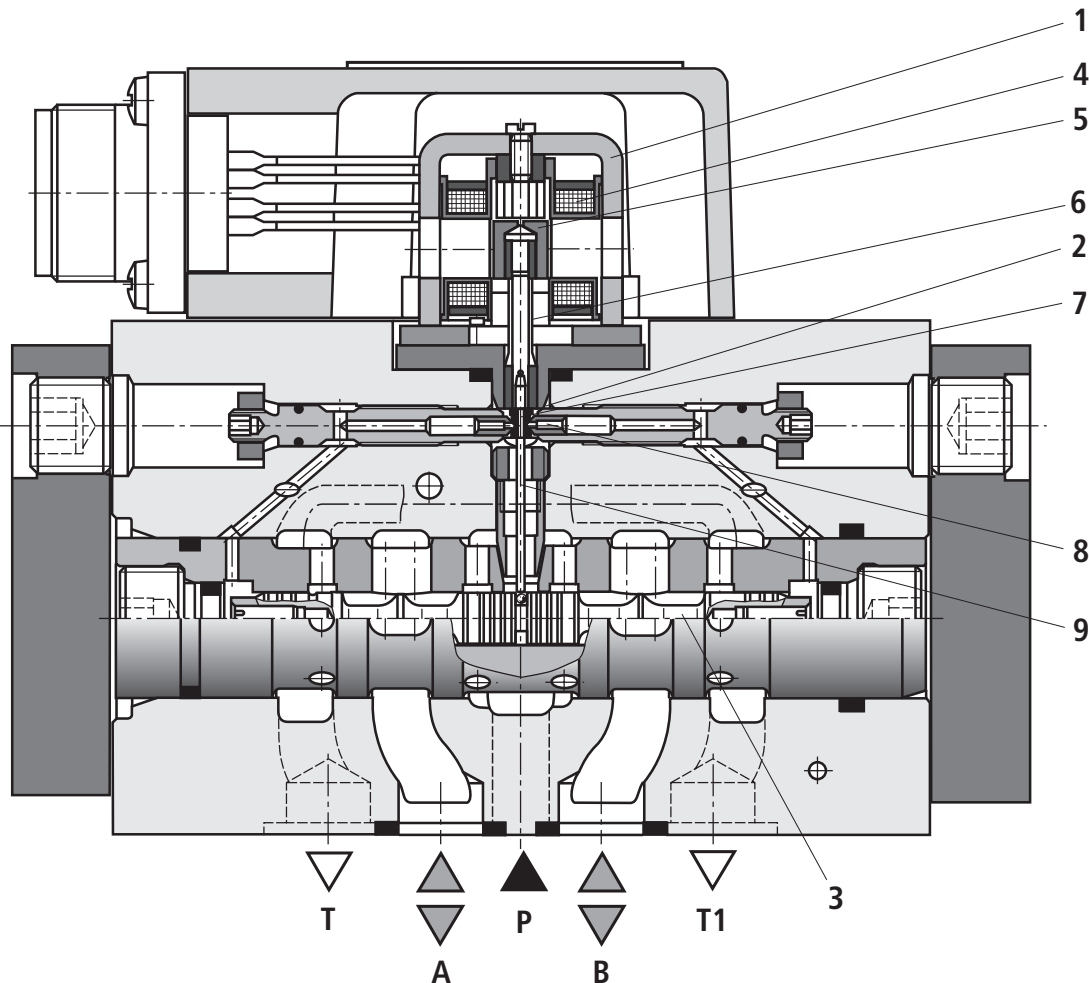

Technical data

General									
Mounting hole configuration	ISO 4401-05-05-0-05								
Installation position	Optional (ensure that pilot control is certain to receive sufficient pressure (≥ 10 bar) when starting up the system!)								
Surface protection	Valve body, cover and filter screw	Nitrocarburized							
	Cap	Anodized							
Storage temperature range	$^{\circ}\text{C}$	-20 ... +70							
Ambient temperature range	$^{\circ}\text{C}$	-20 ... +60							
Weight	kg	3.56							
Hydraulic									
Working pressure:	Control oil supply pilot stage	bar	10 ... 210 or 10 ... 315						
	Main valve, ports P, A, B	bar	up to 315						
Return pressure:	Port T								
	Internal control oil return	bar	Pressure peaks < 100 permitted						
	External control oil return	bar	up to 315						
	Port Y	bar	Pressure peaks < 100 permitted, static < 10						
Pressure fluid			Mineral oil (HL, HLP) to DIN 51524, other pressure fluids available on request, ignition temperature > 150 $^{\circ}\text{C}$						
Pressure fluid temperature range	$^{\circ}\text{C}$		-15 ... +60, preferably +40 ... +50						
Viscosity range	mm^2/s		15 ... 380, preferably 30 ... 45						
Maximum permissible degree of contamination of pressure fluid Purity class to ISO 4406 (c)			Class 18/16/13 ¹⁾						
Zero flow $q_{v,L}$ ²⁾ with spool overlap E measured without dither signal	l/min	$\sqrt{\frac{p_p^{(4)}}{70\text{bar}} \cdot 0.7 \frac{\text{L}}{\text{min}}}$	$\sqrt{\frac{p_p^{(4)}}{70\text{bar}} \cdot 0.9 \frac{\text{L}}{\text{min}}}$	$\sqrt{\frac{p_p^{(4)}}{70\text{bar}} \cdot 1.2 \frac{\text{L}}{\text{min}}}$	$\sqrt{\frac{p_p^{(4)}}{70\text{bar}} \cdot 1.5 \frac{\text{L}}{\text{min}}}$	$\sqrt{\frac{p_p^{(4)}}{70\text{bar}} \cdot 1.7 \frac{\text{L}}{\text{min}}}$			
Nominal flow $q_{v,nom}$ ³⁾ , Tolerance $\pm 10\%$ at valve pressure drop $\Delta p = 70$ bar (35 bar per edge)	l/min	5	10	20	30	45	60	75	90
Max. possible control spool stroke based on mechanical end position (in case of fault) referred to nominal stroke	%	120 ... 170			120 ... 150				
Return system		mechanically							
Hysteresis (dither optimized)	%	≤ 1.5							
Range of inversion (dither optimized)	%	≤ 0.3							
Response sensitivity (dither optimized)	%	≤ 0.2							
Pressure gain with 1 % spool stroke variation (starting from hydr. zero)	% of p_p	≥ 30			≥ 60		≥ 80		
Zero adjustment flow over entire working pressure range	%	≤ 3 , long-term ≤ 5							
Zero offset on variation of:									
Pressure fluid temperature	% / 20 K	≤ 1							
Ambient temperature	% / 20 K	≤ 1							
Working pressure 80 ... 120 % of p_p	% / 100 bar	≤ 2							
Return pressure 0 ... 10 % of p_p ⁴⁾	% / bar	≤ 1							

¹⁾ The purity classes stated for the components must be complied with in hydraulic systems. Effective filtration prevents problems and also extends the service life of components. For a selection of filters, see www.boschrexroth.com/filter.

²⁾ $q_{v,L}$ = zero flow in l/min

³⁾ $q_{v,nom}$ = nominal flow in l/min

⁴⁾ p_p = working pressure in bar

Technical data

Electrical			
Degree of protection of valve to EN 60529		IP 65 with correctly mounted and secured plug-in connector	
Type of signal		analog	
Nominal current per coil	mA	30	
Resistance per coil	Ω	85	
Inductance at 60 Hz and 100 % nominal current:	Connection in parallel	H	0.25
In case of actuation using non-Rexroth amplifiers, we recommend a superimposed dither signal			

Information on explosion protection

Type test certification		FM Approved	
Range of application to according Article 505, NEC [®]		IS Class I, Zone 0, AEx ia IIC T4	
		NI Class I, Zone 2	
Ambient temperature range	$^{\circ}\text{C}$	-20 ... +60	
Pressure fluid temperature range	$^{\circ}\text{C}$	-15 ... +60	
Valve is only supplied with power from certified, intrinsically safe circuits with the following maximum values	U_{\max}	V	9.3
	I_{\max}	mA	390
	P_{\max}	mW	907
Conditions for use in Zone 0		<p>The valve cap consists of cast aluminium.</p> <p>When the valve is to be used as a Category 1 device in Zone 0, the valve cap must be protected in such a manner that no ignitable sparks from friction, impact or grinding can be produced, even in the event of rarely occurring malfunctions.</p> <p>Note: The hydraulic fluid used must have an ignition temperature of at least 150 $^{\circ}\text{C}$.</p>	
Required free space for burst protection		The specified free space for burst protection (see Page 12) must remain free, in order that excess pressure occurring in the event of a fault can be dissipated through the plug in the valve cap.	
Additional requirements for use in zone 0		Safety barrier required	
Additional requirements for use in zone 2		May be used without safety barrier	

External trigger electronics

Servo amplifier ¹⁾ in modular design	Analog	Typ VT 11021 as per Technical Data Sheet RE 29743
Recommended safety barrier ¹⁾	Single-channel	Messrs. Stahl, Type 9001/02-093-390-101

Note:

The servo amplifier and safety barrier must be operated **outside** the potentially explosive atmosphere!

¹⁾ Order separately

Plug-in connector

Plug-in connector to EN 175201-804

Metal version

Order separately under Material No. **R900223890**

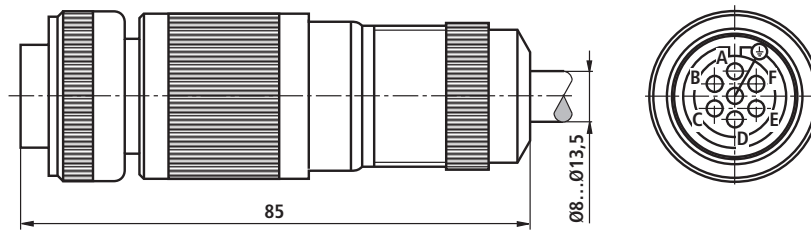

Electrical connection

The electrical connection may only be connected **in parallel**.

The electrical actuation with positive (+) to A and B and negative (-) to C and D produces a volumetric flow direction of P → A and B → T. Inverse electrical actuation produces a volumetric flow direction of P → B and A → T.

Pins E, F and PE on the plug are not connected.

Zone 0

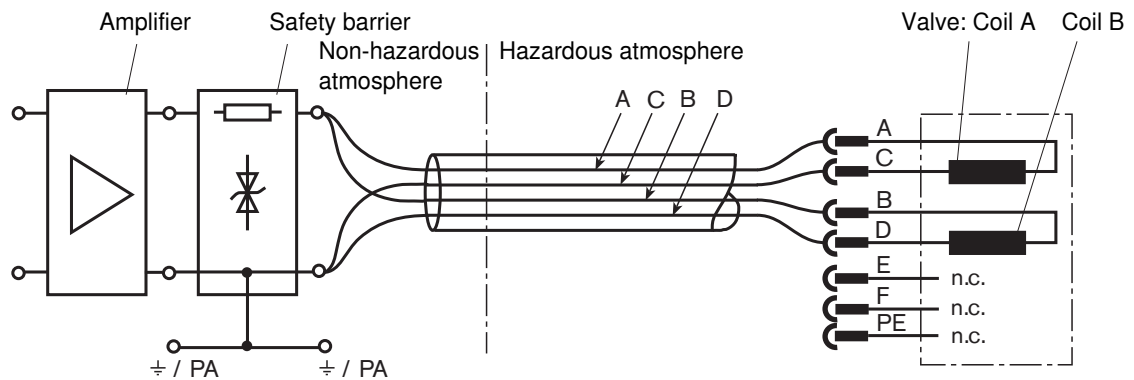

Safety barrier required

Note

Only approved cables and leads may be used for intrinsically safe circuits.

The Entity Concept allows interconnection of intrinsically safe apparatus with associated apparatus not specifically examined in combination as system when:

$$V_{max} > V_{oc} \text{ or } V_t; I_{max} > I_{sc} \text{ or } I_t; C_a > C_i + C_{cable}; L_a > L_i + L_{cable}$$

Control equipment connected to barrier must not use or generate more than 250 Vrms or Vdc.

The configuration of associated apparatus must be FM Approved.

Zone 2

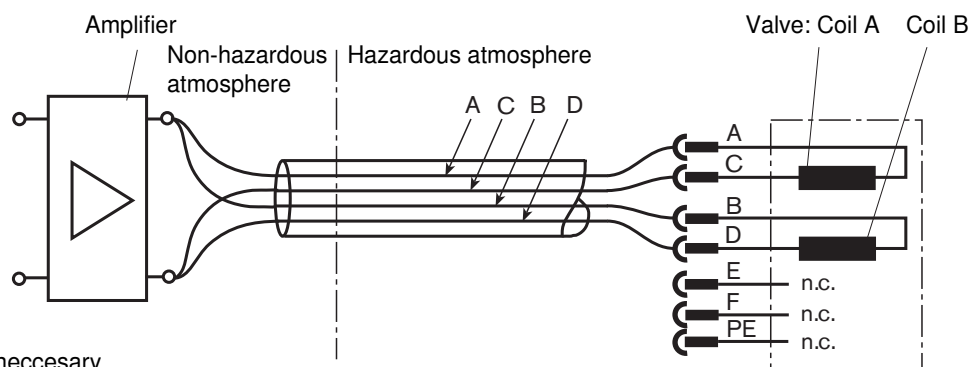

Safety barrier not necessary

Characteristic curves (measured with HLP 32, $\vartheta_{oil} = 40 \text{ }^\circ\text{C} \pm 5 \text{ }^\circ\text{C}$)

Flow - load function (tolerance $\pm 10 \%$) with 100 % setpoint signal

Note:

Observe flow values in the max. setpoint range (see tolerance zone of flow signal function)

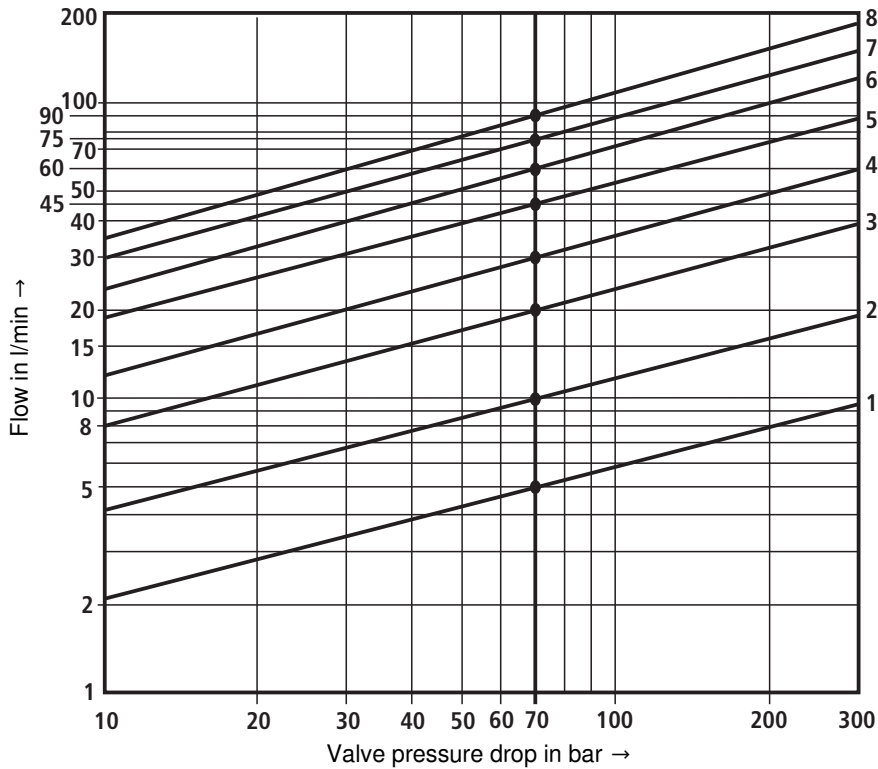

Order code	Nominal flow	Curve
5	5 l/min	1
10	10 l/min	2
20	20 l/min	3
30	30 l/min	4
45	45 l/min	5
60	60 l/min	6
75	75 l/min	7
90	90 l/min	8

Δp = valve pressure drop
(supply pressure p_p minus load pressure p_L and minus return pressure p_T)

Tolerance zone of flow signal function

at a constant metering edge pressure drop

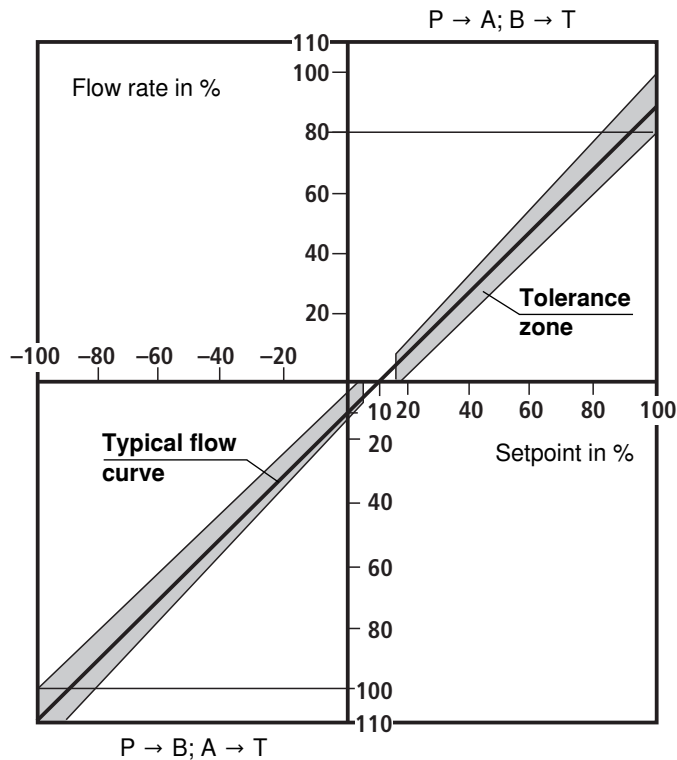

Characteristic curves (measured with HLP 32, $\vartheta_{oil} = 40 \text{ }^\circ\text{C} \pm 5 \text{ }^\circ\text{C}$)

Unit step response with pressure stage 315 bar, without flow (measured with safety barrier ¹⁾)

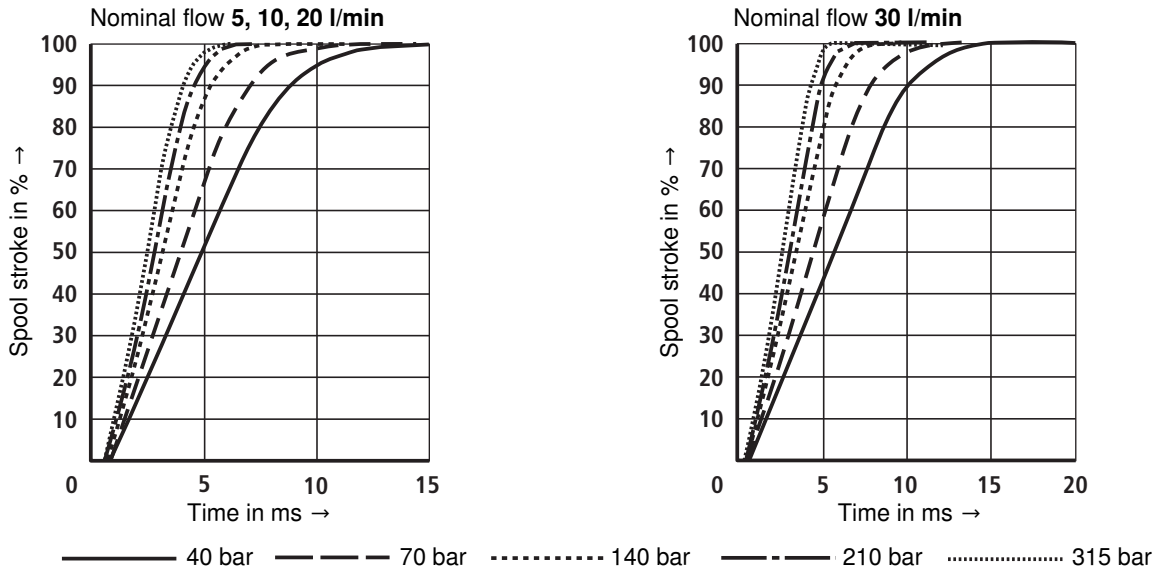

Frequency response with pressure stage 315 bar, stroke frequency response without flow (measured with safety barrier ¹⁾)

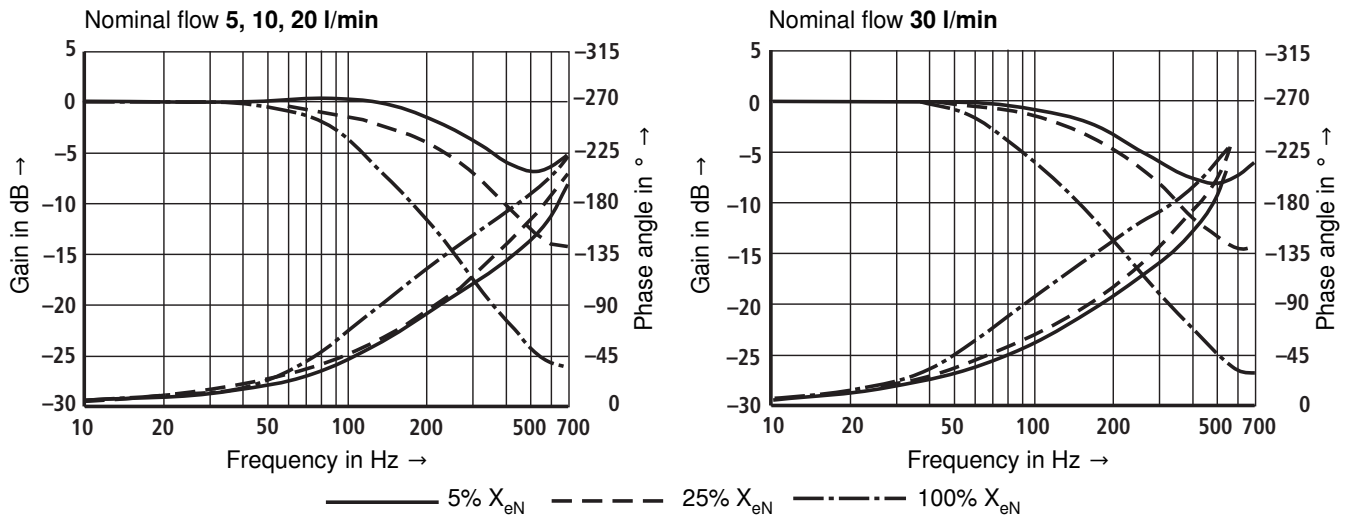

Dependence of frequency f at -90° on working pressure p and input amplitude (measured with safety barrier ¹⁾)

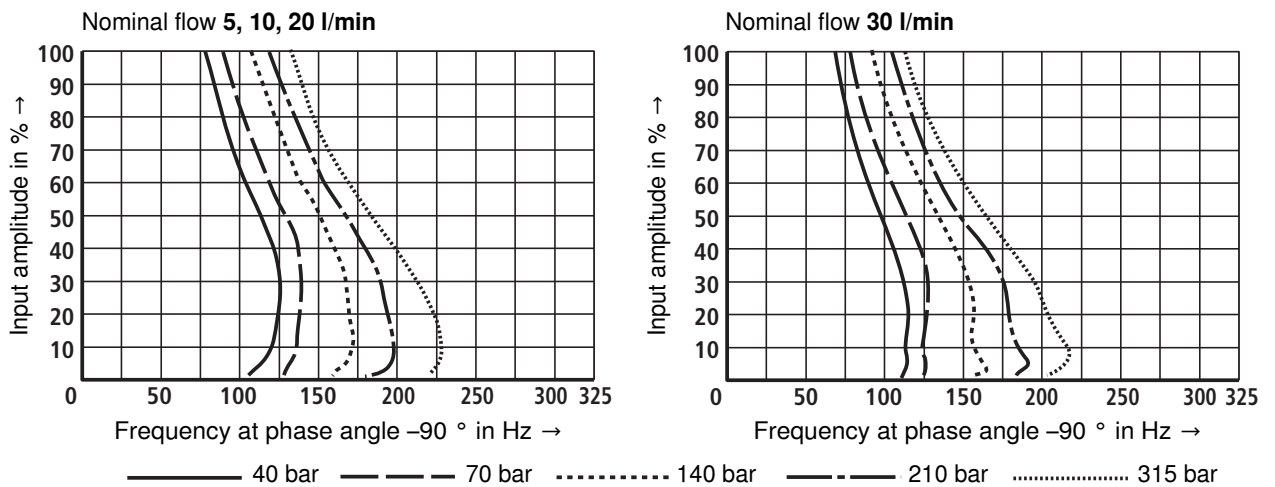

¹⁾ see pages 6 and 7 for information on the safety barrier

Characteristic curves (measured with HLP 32, $\dot{v}_{oil} = 40 \text{ }^\circ\text{C} \pm 5 \text{ }^\circ\text{C}$)

Unit step response with pressure stage 315 bar, without flow (measured with safety barrier ¹⁾)

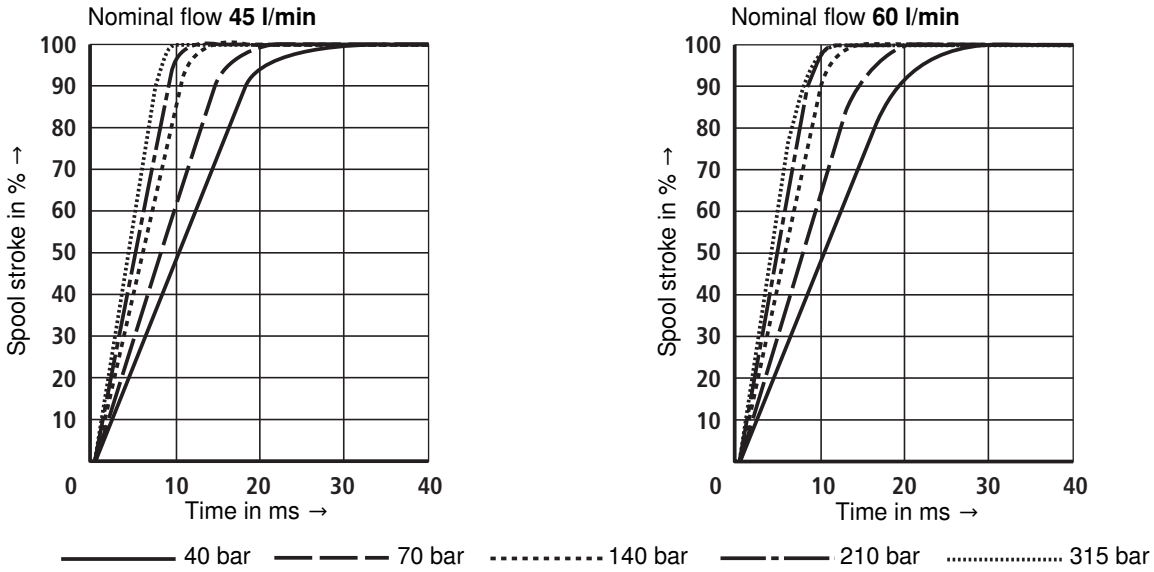

Frequency response with pressure stage 315 bar, stroke frequency response without flow (measured with safety barrier ¹⁾)

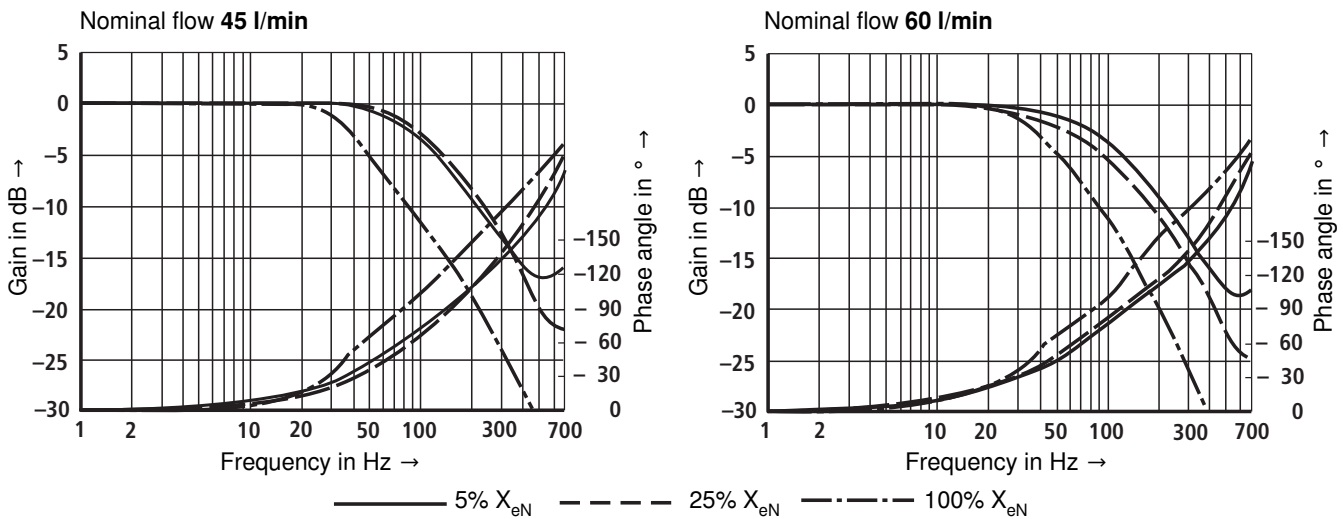

Dependence of frequency f at -90° on working pressure p and input amplitude (measured with safety barrier ¹⁾)

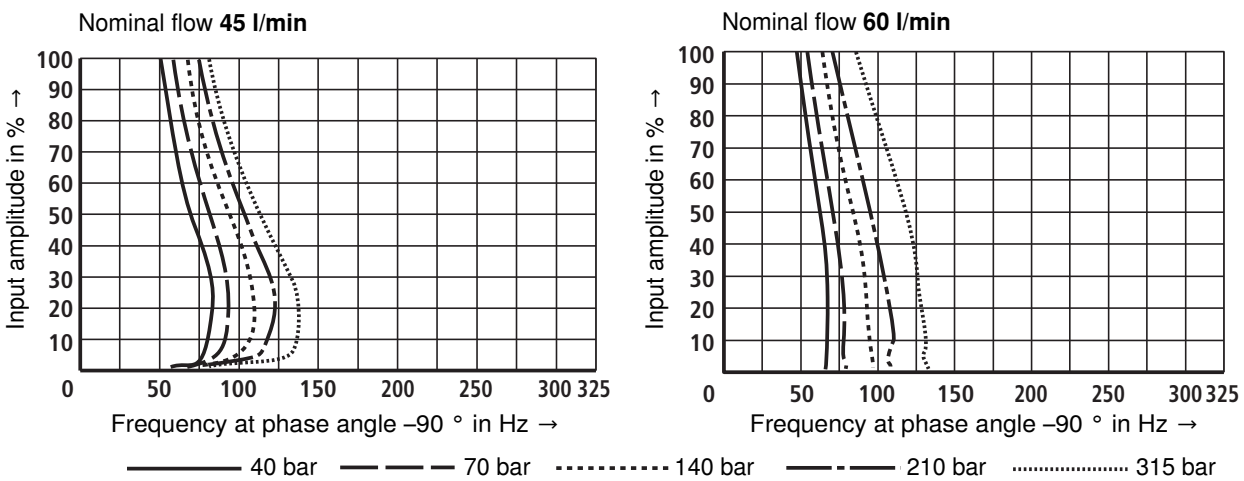

¹⁾ see pages 6 and 7 for information on the safety barrier

Characteristic curves (measured with HLP 32, $\vartheta_{oil} = 40 \text{ }^\circ\text{C} \pm 5 \text{ }^\circ\text{C}$)

Unit step response with pressure stage 315 bar, without flow (measured with safety barrier ¹⁾)

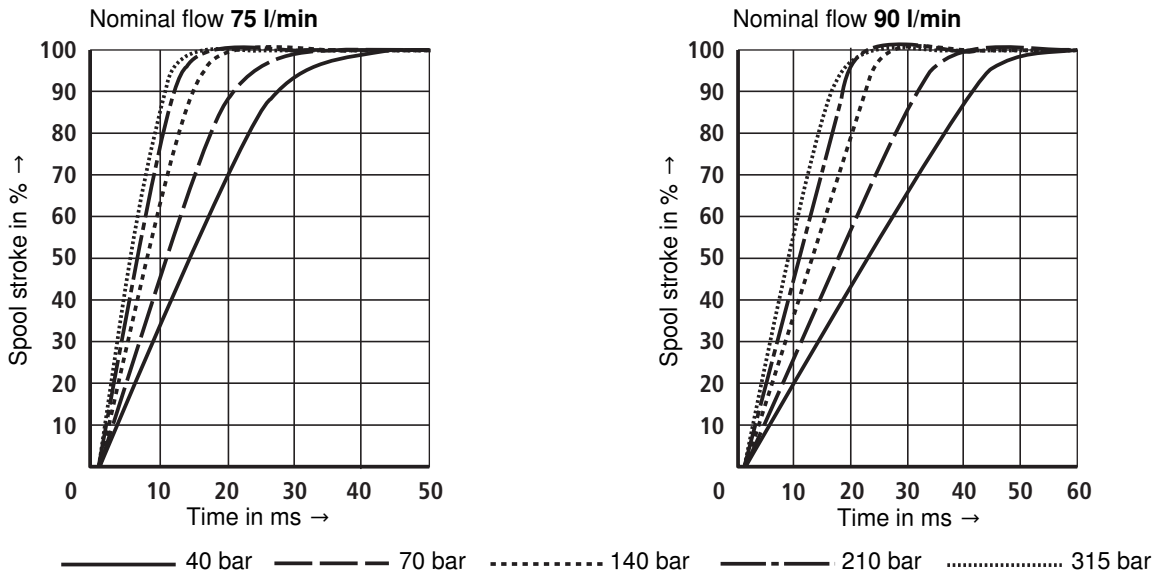

Frequency response with pressure stage 315 bar, stroke frequency response without flow (measured with safety barrier ¹⁾)

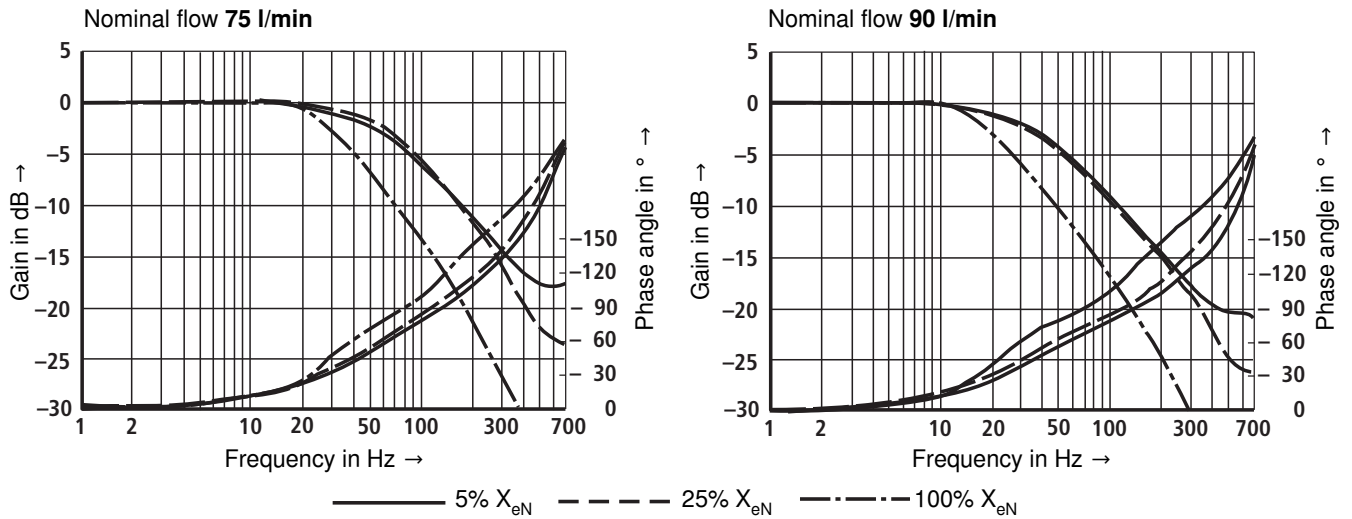

Dependence of frequency f at -90° on working pressure p and input amplitude (measured with safety barrier ¹⁾)

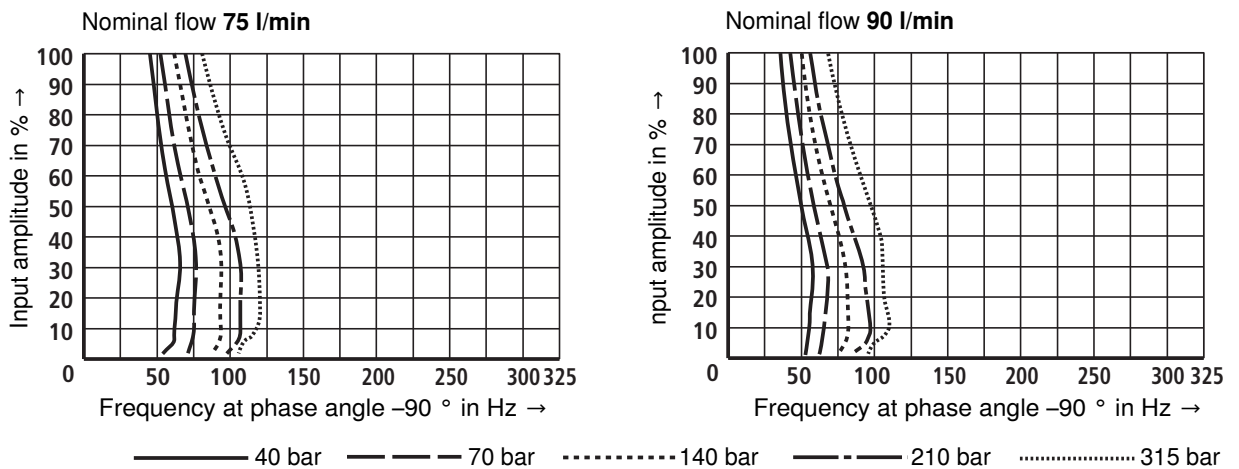

¹⁾ see pages 6 and 7 for information on the safety barrier

Unit dimensions (Dimensions in mm)

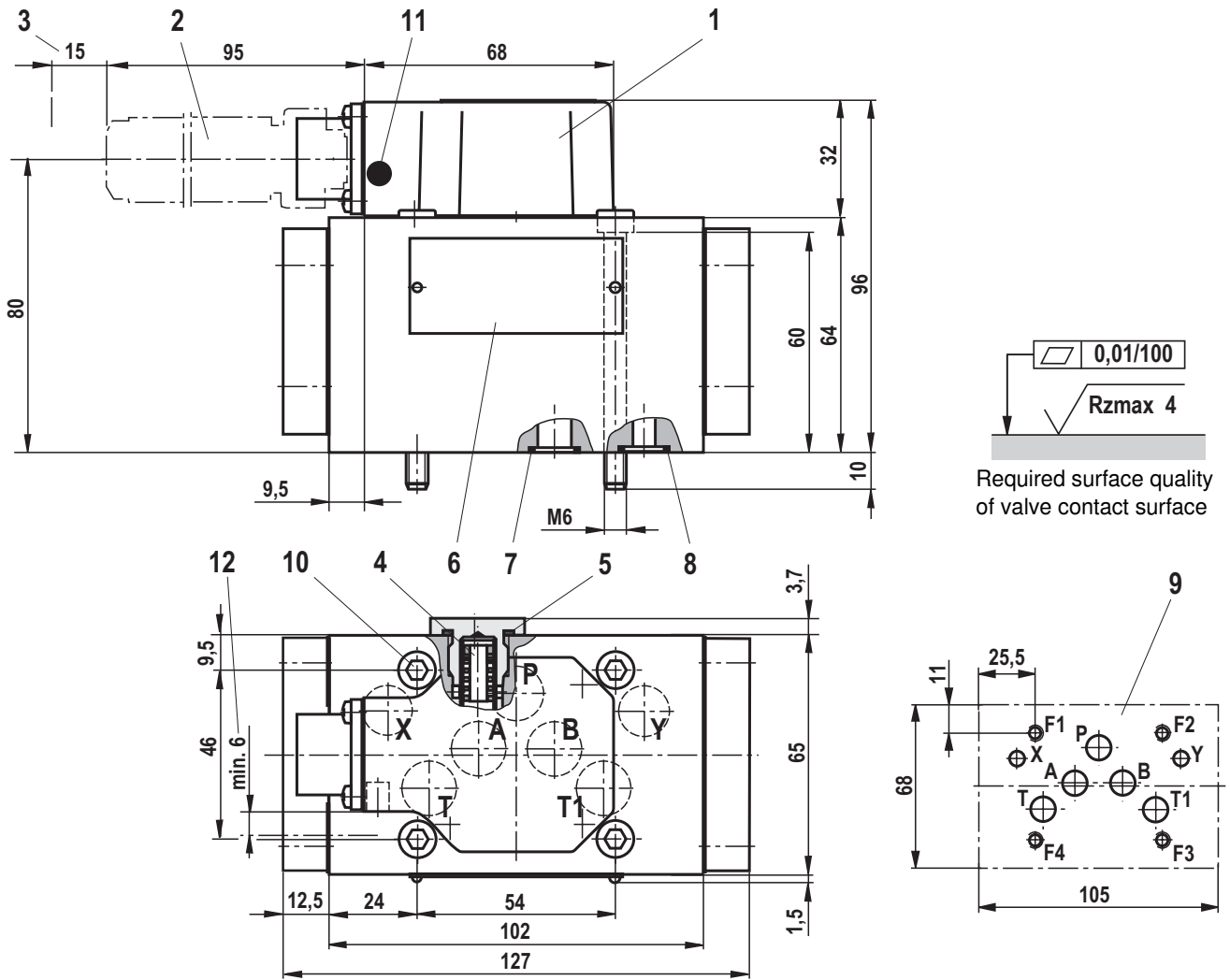

- 1 Cap
- 2 Plug-in connector
(order separately, see page 7)
- 3 Required space for removing plug-in connector,
note additional bending radius of connecting cable
- 4 Exchangeable filter element with seals
Material no.: **R961001950**
- 5 Profile seal for filter screw M16 x 1.5, part of item 4
- 6 Nameplate
- 7 Same seals for ports P, A, B, T and T1
- 8 Same seals for ports X and Y
Ports X and Y are also subjected to pressure when
control oil is "internal".
- 9 Machined valve contact surface
Position of connections in accordance with
ISO 4401-05-05-0-05, T1 connection also be used

- 10 Valve fastening screws
For strength reasons only the following
valve fastening screws may be used:
4 cheese-head bolts
ISO 4762-M6 x 70-10.9-flZn-240h-L
(Friction coefficient 0.09 - 0.14)
(Included in scope of delivery)
- 11 Burst protection
- 12 Free space for burst protection

Subplates

- G 66/01 FE/ZN (G3/8)
- G 67/01 FE/ZN (G1/2)
- with ports X and Y:
- G 535/01 FE/ZN (G3/4)
- G 535/02 FE/ZN (M27 x 2)
- G 536/01 FE/ZN (G1)
- G 536/02 FE/ZN (M33 x 2)
- with dimensions like in data sheet RE 45054 (must be
ordered separately)

Flushing plate with mounting hole configuration to ISO 4401-05-05-0-05 (Dimensions in mm)

Symbol

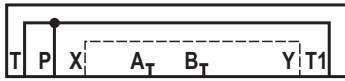

- Material No. **R900912450**
- weight: 2 kg
- Same seals for ports P, A, B, T and T1
- Same seals for X, Y
- Fastening screws
For strength reasons only the following valve fastening screws may be used:
4 cheese-head bolts
ISO 4762-M6 x 50-10.9-fZn-240h-L
(Friction coefficient 0.09 - 0.14)
(Included in scope of delivery)

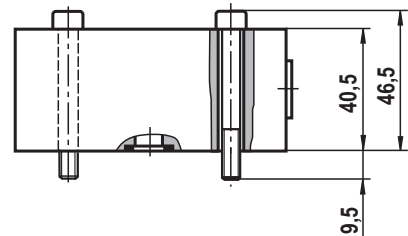

Note

In order to ensure that the servo valves function perfectly, it is essential to flush the system before commissioning it into service.

For procedure see Product-specific Instructions
RA 29583-VH1-100-B2

Notes

Notes

Bosch Rexroth AG
Hydraulics
Zum Eisengießer 1
97816 Lohr am Main, Germany
Telefon +49 (0) 93 52 / 18-0
documentation@boschrexroth.de
www.boschrexroth.de

© This document, as well as the data, specifications and other information set forth in it, are the exclusive property of Bosch Rexroth AG. It may not be reproduced or given to third parties without its consent. The data specified above only serve to describe the product. No statements concerning a certain condition or suitability for a certain application can be derived from our information. The information given does not release the user from the obligation of own judgment and verification. It must be remembered that our products are subject to a natural process of wear and aging.

Notes
