



**Air Preparation Products**  
Global Air Preparation Series

<a href="#">Introduction</a>	B2-B7
<a href="#">Particulate Filters</a>	B8-B13
<a href="#">Coalescing Filters</a>	B14-B19
<a href="#">Regulators</a>	B20-B31
<a href="#">Proportional Regulators</a>	B32-B41
<a href="#">Filter / Regulators</a>	B42-B49
<a href="#">Lubricators</a>	B50-B55
<a href="#">Combinations</a>	B56-B59
<a href="#">Dump Valves / Soft Start Valves</a>	B60-B65
<a href="#">Redundant Safety Exhaust Valve</a>	B66-B69
<a href="#">Accessories</a>	B70-B80

**B**  
Global Air Preparation



For inventory, lead time, and kit lookup, visit [www.pdnplu.com](http://www.pdnplu.com)

<b>B</b>
Global Air Preparation
Introduction
Filters
Coalescers
Regulators
Filter / Regulators
Lubricators
Combinations
Accessories and Kits



**DECLARATION OF COMPLIANCE (ROHS)**

European Directive 2011/65/EU – RoHS (Restriction us of certain Hazardous Substances in electrical and electronic equipment), restricts the use of the 6 substances in the manufacture of specified electrical equipment.

**Lead:** Product containing lead and its compound (except for applications of lead as an alloying element by weight in steel up to 0.35%, in aluminium up to 0.4% and in copper alloys up to 4% and in circuit board solder) must not exceed 0.1% by weight

**Mercury:** The concentration level must not exceed 0.1% by volume

**Cadmium:** The concentration level must not exceed 0.01% by volume

**Hexavalent Chromioui:**  
This is a corrosive protective finish used on our product line. Where this finish is utilized the Chromate solution is Hexavalent (Chrome 6) free.

**Polybrominated Biphenyls (PBB):**  
The concentration level must not exceed 0.1% by weight. This substance is not know to be in any of our products.

**Polybrominated Diphenyl Esters (PBDE):**  
The concentration level must not exceed 0.1% by weight. This substance is not know to be in any of our products.



Global Air Preparation products supplied by Parker Hannifin have been designed and manufactured in accordance with “sound engineering practice”, as defined by Article 3 of Pressure Equipment Directive 97/23/EC.



Global Air Preparation product range is in compliance with REACH to ensure continued compliance additions to the list of SVHC (Substance of Very High Concern) are reviewed periodically.

Global Air Preparation product range has been third party Shock & Vibration tested independently in accordance to EN 61373 : 1999, Category 2



Following Ignition Hazard Assessments performed on the non-electrical Global Air Preparation products they are in accordance with the requirements of EN 13463-1:2009, it was considered that the equipment does not contain its own source of ignition, and therefore is not within the scope of directive 94/9/EC.

The products can be used in a Group II Category 2 environment assuming that the ATEX Directive and the following conditions are complied with:

- Installation and maintenance of the product must be undertaken by qualified personnel.
- Do not mount the products in an area where impact may occur.
- Filters must be used to limit the introduction of particles and to capture particles generated in service.
- Supply air quality must be within ISO 8573-1:2010 Class 1.4.2.
- Maximum working temperature to be as stated on product label.
- WARNING – pulsating pressure and/or a closed circuit can generate heat.
- Deposits of dust on the product must not exceed 5mm thickness.  
Refer to technical file for surface areas of plastics. The unit must be earthed via the compressed air supply line.
- The unit must not come into contact with liquid solvents, acids or alkalis  
Refer to technical file for chemicals known to be incompatible. Product cleaning must be undertaken using a method complying with the specifications of the ATEX zone, preferably by using mild soap and water or antistatic products.
- Regulators, Filter Regulators:  
Do not use Regulators or Filter Regulators within systems that can create vibration within the Regulator / Filter Regulator unit.
- Solenoid Operated Valves:  
Are suitable for use in an ATEX environment, (Group II Category 2) providing ATEX approved solenoids are fitted.
- Technical file available on request.



Global Air Preparation product range has been designed and tested in accordance with ISO flow testing, envelope integrity, and catalog data presented.

- Filters – ISO 5782-1 & ISO 5782-2: 1997
- Regulators- ISO 6953-1 & ISO 6953-2: 2000
- Lubricators- ISO 6301-1 & ISO 6301-2: 2009



For inventory, lead times, and kit lookup, visit [www.pdnplu.com](http://www.pdnplu.com)

# Parker Global Air Preparation System

**Global.  
Modular.**



*Performance you need,  
wherever you need it.*



Full featured particulate and coalescing filters, regulators, filter/regulators, and lubricators are available with a wide range of standard options to meet air preparation needs.

The comprehensive Global Air Preparation System is available in three body sizes with either BSPP, BSPT, or NPT to accommodate thread type requirements.

Individual units can easily be assembled into various combinations, utilizing patented modular lightweight body connectors.

[www.parker.com/globalfrl](http://www.parker.com/globalfrl)

**B**

Global Air Preparation

Introduction

Filters

Coalescers

Regulators

Filter/  
Regulators

Lubricators

Combinations

Accessories  
and Kits



For inventory, lead time, and kit lookup, visit [www.pdnplu.com](http://www.pdnplu.com)

B3

**Parker Hannifin Corporation**  
Pneumatic Division  
Richland, Michigan  
[www.parker.com/pneumatics](http://www.parker.com/pneumatics)

# A completely modular air preparation system

B
Global Air Preparation
Introduction
Filters
Coalescers
Regulators
Filter / Regulators
Lubricators
Combinations
Accessories and Kits

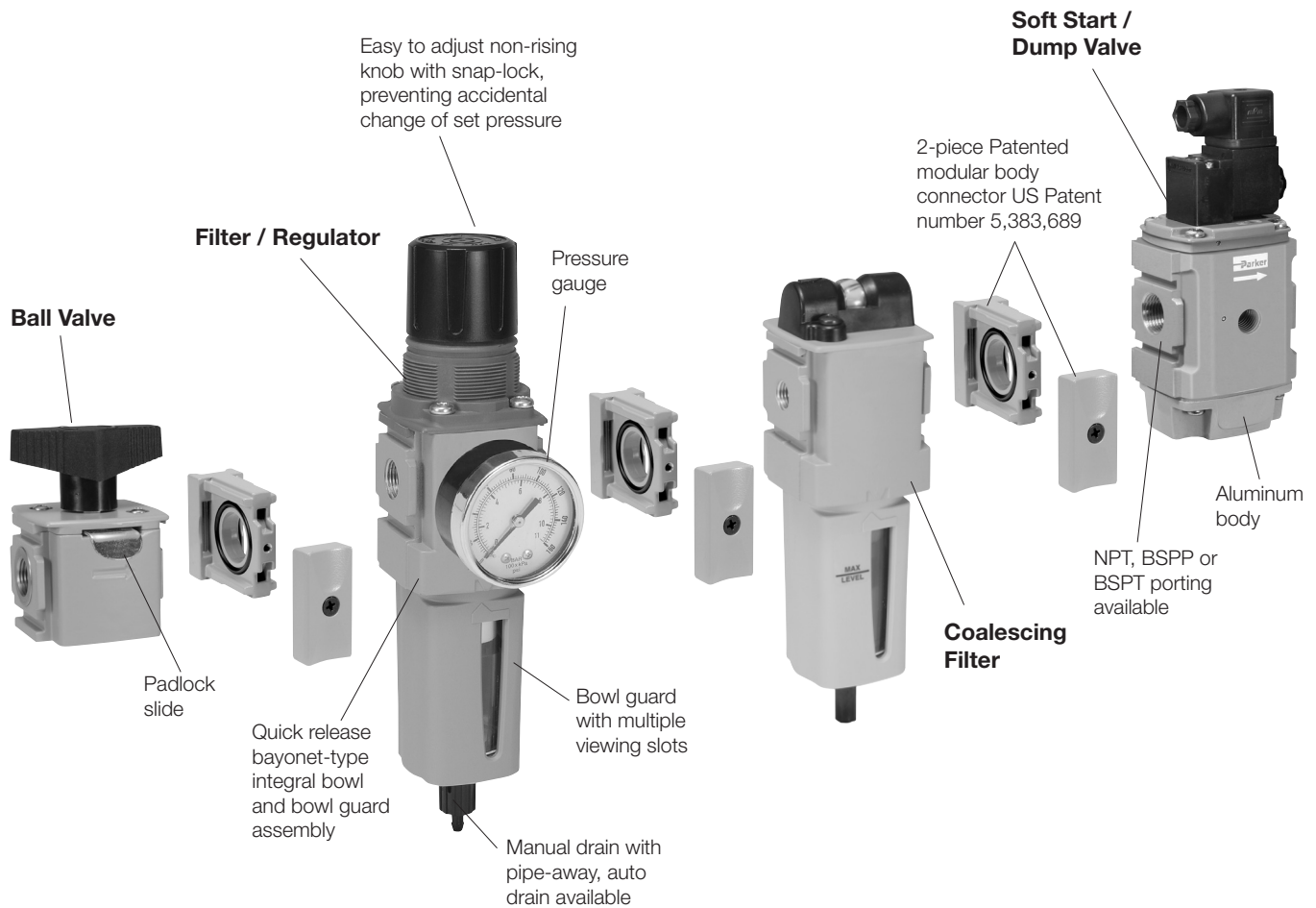

For inventory, lead times, and kit lookup, visit [www.pdnplu.com](http://www.pdnplu.com)

# Comprehensive Offering



**P31 Mini Series**  
1/4" ports  
40mm body width



**P32 Compact Series**  
1/4", 3/8" and 1/2"  
60mm body width



**P33 Standard Series**  
1/2" and 3/4"  
73mm body width



## Filters

- 5 $\mu$  particulate, 1.0 $\mu$  and 0.01 $\mu$  coalescing, and adsorber available as standard
- Transparent or metal bowl with manual or auto float drains standard



## Regulators

- Available as stand alone, common port and electronic proportional
- Both relieving and non-relieving versions available



## Filter / Regulators

- Compact design for space savings
- Available with all the same standard options as the filters and regulators



## Lubricators

- Proportional oil delivery over a wide range of air flows
- Fill under pressure



## Combinations

- Compact design for space savings
- Easily assembled
- Many configurations available



## Accessories

- Solenoid operated soft start, quick dump, and soft start/quick dump valves
- Manifold blocks
- Ball style lockout / shutoff valve
- Repair kits, gauges, etc.

**B**

Global Air Preparation

Introduction

Filters

Coalescers

Regulators

Filter / Regulators

Lubricators

Combinations

Accessories and Kits



For inventory, lead time, and kit lookup, visit [www.pdnplu.com](http://www.pdnplu.com)

# Air Preparation

## P31 Mini Series

40mm body width

1/4" Ported

Flows up to:	scfm	(dm <sup>3</sup> /s, ANR)
Filter	25	(12)
Coalescer	7.5	(3.6)
Regulator	68	(32)
Filter/Regulator	22	(10)
Lubricator	52	(25)

Features:

- Space saving integral gauge
- Manifold style regulators available
- OSHA compliant shut-off valves
- Soft-Start & Quick Dump valves
- Electronic Proportional Regulator

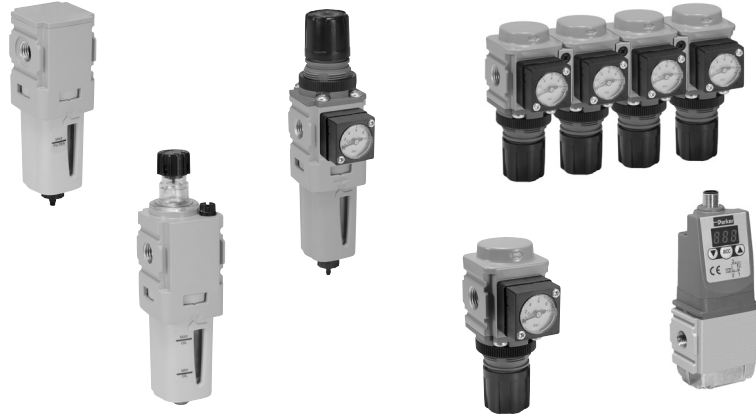

## P32 Compact Series

60mm body width

1/4", 3/8", & 1/2" Ported

Flows up to:	scfm	(dm <sup>3</sup> /s, ANR)
Filter	82	(39)
Coalescer	36	(17)
Regulator	165	(78)
Filter/Regulator	136	(64)
Lubricator	90	(42)

Features:

- Manifold style regulators available
- OSHA Compliant shut-off valves
- Soft-Start & Quick Dump valves
- Electronic Proportional Regulator



## P33 Standard Series

73mm body width

1/2" & 3/4" Ported

Flows up to:	scfm	(dm <sup>3</sup> /s, ANR)
Filter	85	(40)
Coalescer	72	(34)
Regulator	233	(111)
Filter/Regulator	230	(108)
Lubricator	150	(71)

Features:

- OSHA Compliant shut-off valves
- Soft-Start & Quick Dump valves (Utilizes P32 size only)
- Electronic proportional regulator (Utilizes P32 size only)



**B**  
 Global Air Preparation  
 Introduction  
 Filters  
 Coalescers  
 Regulators  
 Filter / Regulators  
 Lubricators  
 Combinations  
 Accessories and Kits



For inventory, lead times, and kit lookup, visit [www.pdnplu.com](http://www.pdnplu.com)

# Complete Pneumatic System

## Common Port Manifold Regulators

- Multiple output pressures (P2, P3, P4, etc.) with common inlet (P1)
- Available in two sizes P31 and P32
- Balanced valve design for accurate pressure regulation
- Outlet pressure ports in front and rear of unit.
- Multiple spring ranges available

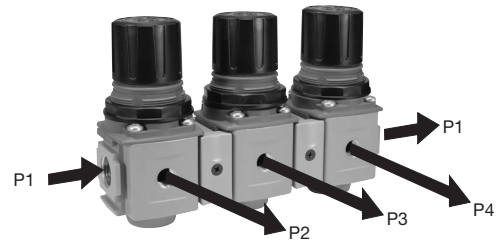

## Electronic Proportional Regulator

- Electro-Pneumatic regulator
- Integrated systems control
- Accurate output pressure
- Micro parameter settings
- Selectable I/O parameters
- Quick, full flow exhaust
- LED display indicates output pressure
- No air consumption in steady state
- Multiple mounting options
- Protection to IP65



P31P Mini Series



P32P Compact Series

## Semi Precision Regulator and Filter/Regulator

- Available in P32 compact series
- Fine adjustment sensitivity
- Good repeatability and minimal pressure drop
- Good flow capacity
- Light gray knob for easy identification



## Optional Tamperproof Kits

- One facilitates the permanent tamperproofing of the Regulator and Filter/Regulator units
- Hinged black part clamps over control knob and is locked in place after sliding yellow cover over it
- Other allows for removable lockout/tagout tamperproofing
  - Four pad lock location holes tagout
  - Hinged locking clamp secures over existing knob via yellow cover which is slid over into place



## Additional Options P32 Only (Consult factory for availability)

- T-Handle
- Preset
- Preset and Tamperproof
- Pressure Limiter



For inventory, lead time, and kit lookup, visit [www.pdnplu.com](http://www.pdnplu.com)

**P31 Particulate Filter – Mini**

- Integral 1/4" ports (NPT, BSPP & BSPT)
- High efficiency 5 micron element as standard
- Excellent water removal efficiency
- Robust but lightweight aluminum construction
- One hand operation for easy element cartridge removal
- Positive bayonet latch to ensure correct & safe fitting

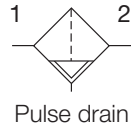
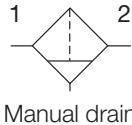

**Operating information**

Supply pressure (max):	
Plastic bowl	150 psig (10 bar)
Metal bowl	250 psig (17 bar)
Operating temperature:	
Plastic bowl	14°F to 125°F (-10°C to 52°C)
Metal bowl	14°F to 150°F (-10°C to 65.5°C)
Standard filtration:	5 micron
Flow capacity*:	25 scfm (12 dm <sup>3</sup> /s, ANR)
Useful retention†:	0.4 US oz. (12 cm <sup>3</sup> )
Weight:	0.24 lb (0.11 kg)
* Inlet pressure 91.3 psig (6.3 bar). Pressure drop 4.9 psig (0.34 bar).	
† Useful retention refers to volume below the quiet zone baffle.	

Port size	Description †	Part number
1/4"	Poly bowl, manual drain	<b>P31FB92EGMN</b>
1/4"	Poly bowl, pulse drain	<b>P31FB92EGBN</b>
1/4"	Metal bowl, manual drain	<b>P31FB92EMMN</b>
1/4"	Metal bowl, pulse drain	<b>P31FB92EMBN</b>

† For polycarbonate bowl, see caution in Engineering Section A.

**Air quality:**  
 Within ISO 8573-1: 1991 Class 3 (Particulates)  
 Within ISO 8573-1: 2001 Class 6 (Particulates)

**Ordering information:**

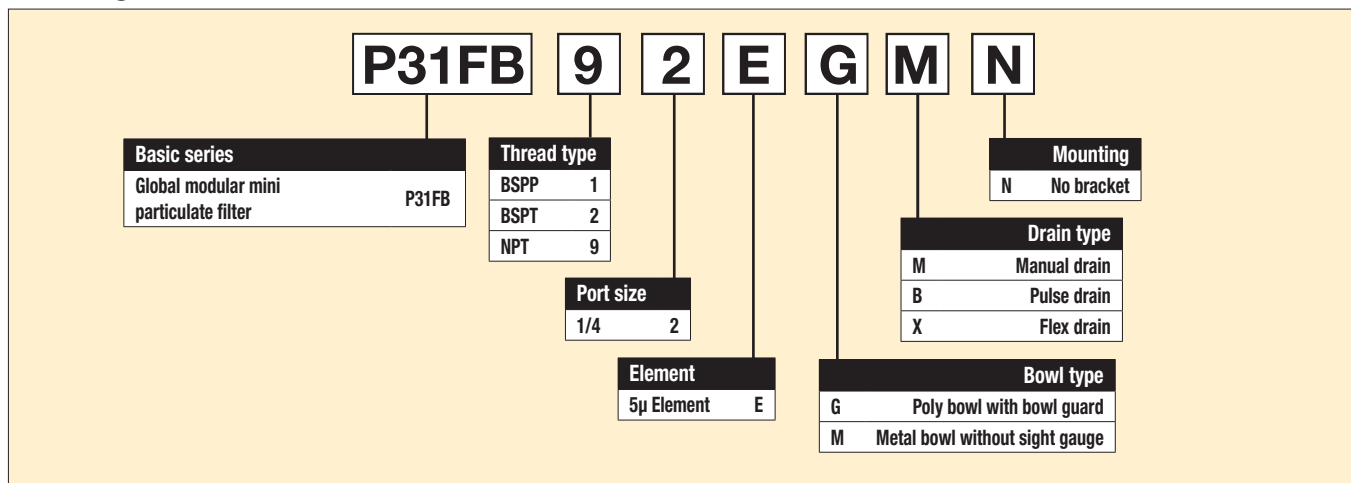

Most popular.



For inventory, lead times, and kit lookup, visit [www.pdnplu.com](http://www.pdnplu.com)

**B**  
 Global Air Preparation  
 Introduction  
 Filters  
 Coalescers  
 Regulators  
 Filter / Regulators  
 Lubricators  
 Combinations  
 Accessories and Kits



## Mini Particulate Filters

### Material Specifications

Body	Aluminum
Body cap	ABS
Plastic bowl	Polycarbonate
Metal bowl	Aluminum
Bowl guard	Nylon
Element retainer	Acetal
Baffle	Acetal
Filter element	Sintered polyethylene
Seals	Nitrile

### Repair and Service Kits

Plastic bowl / bowl guard, manual drain	<b>P31KB00BGM</b>
Metal bowl / w/o sight gauge, manual drain	<b>P31KB00BMM</b>
Plastic bowl / bowl guard, pulse drain	<b>P31KB00BGB</b>
Metal bowl / w/o sight gauge, pulse drain	<b>P31KB00BMB</b>
5µ particle filter element	<b>P31KA00ESE</b>
C-bracket (fits to body)	<b>P31KA00MW</b>
T-bracket with body connector	<b>P31KA00MT</b>
Body connector	<b>P31KA00CB</b>

## Air Preparation Products Global Air Preparation

### Flow Charts

#### P31FB 1/4" Filter

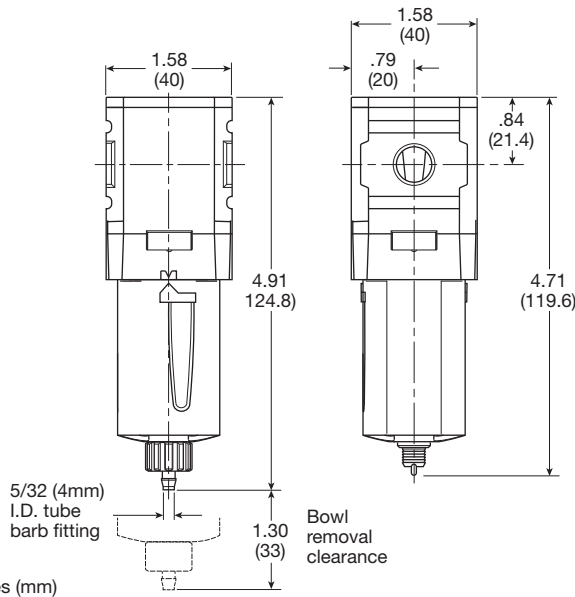
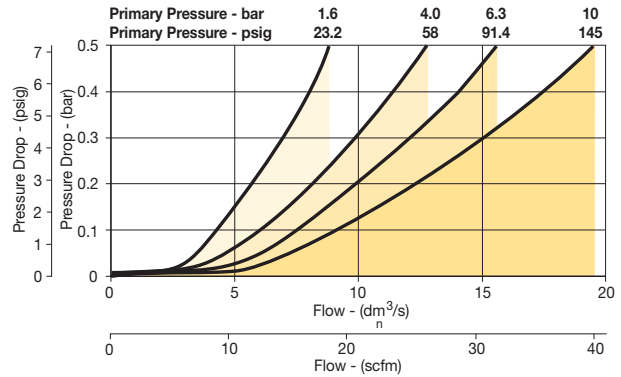

Manual Drain

Pulse Drain

**B**

Global Air Preparation

Introduction

Filters

Coalescers

Regulators

Filter/Regulators

Lubricators

Combinations

Accessories and Kits



For inventory, lead time, and kit lookup, visit [www.pdnplu.com](http://www.pdnplu.com)

**P32 Particulate Filter – Compact**

- Integral 1/4", 3/8" or 1/2" ports (NPT, BSPP & BSPT)
- High efficiency 5 micron element as standard
- Excellent water removal efficiency
- Robust but lightweight aluminum construction
- Positive bayonet latch to ensure correct & safe fitting

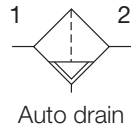
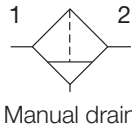

Port size	Description †	Part number
1/4"	Poly bowl, manual drain	<b>P32FB92EGMN</b>
1/4"	Poly bowl, auto drain	<b>P32FB92EGAN</b>
1/4"	Metal bowl, manual drain	<b>P32FB92ESMN</b>
1/4"	Metal bowl, auto drain	<b>P32FB92ESAN</b>
3/8"	Poly bowl, manual drain	<b>P32FB93EGMN</b>
3/8"	Poly bowl, auto drain	<b>P32FB93EGAN</b>
3/8"	Metal bowl, manual drain	<b>P32FB93ESMN</b>
3/8"	Metal bowl, auto drain	<b>P32FB93ESAN</b>
1/2"	Poly bowl, manual drain	<b>P32FB94EGMN</b>
1/2"	Poly bowl, auto drain	<b>P32FB94EGAN</b>
1/2"	Metal bowl, manual drain	<b>P32FB94ESMN</b>
1/2"	Metal bowl, auto drain	<b>P32FB94ESAN</b>

† For polycarbonate bowl, see caution in Engineering Section A.

**Operating information**

Supply pressure (max):	
Plastic bowl	150 psig (10 bar)
Metal bowl	250 psig (17 bar)
Operating temperature:	
Plastic bowl	-13°F to 125°F (-25°C to 52°C)
Metal bowl	-13°F to 150°F (-25°C to 65.5°C)
Standard filtration:	5 micron
Flow capacity*:	
1/4"	50 scfm (24 dm <sup>3</sup> /s, ANR)
3/8"	78 scfm (37 dm <sup>3</sup> /s, ANR)
1/2"	82 scfm (39 dm <sup>3</sup> /s, ANR)
Useful retention†:	1.7 US oz. (51 cm <sup>3</sup> )
Weight:	0.62 lb (0.28 kg)
* Inlet pressure 91.3 psig (6.3 bar). Pressure drop 4.9 psig (0.34 bar).	
† Useful retention refers to volume below the quiet zone baffle.	

**Air quality:**  
 Within ISO 8573-1: 1991 Class 3 (Particulates)  
 Within ISO 8573-1: 2001 Class 6 (Particulates)

**Ordering Information:**

**P32FB 9 2 E G M N**

<b>Basic series</b> Global modular compact particulate filter P32FB	<b>Thread type</b> BSPP 1 BSPT 2 NPT 9	<b>Port size</b> 1/4 2 3/8 3 1/2 4	<b>Element</b> 5µ Element E	<b>Mounting</b> N No bracket
			<b>Drain type</b> M Manual drain A Auto drain X Flex drain	
			<b>Bowl type</b> G Poly bowl with bowl guard M Metal bowl without sight gauge S Metal bowl with sight gauge	

Most popular.



For inventory, lead times, and kit lookup, visit [www.pdnplu.com](http://www.pdnplu.com)

Compact Particulate Filters

Material Specifications

Body	Aluminum
Body cap	ABS
Plastic bowl	Polycarbonate
Metal bowl	Aluminum
Bowl guard	Nylon
Deflector	Polypropylene
Element retainer / Baffle	Acetal
Filter element	Sintered polyethylene
Seals	Nitrile
Sight gauge	Nylon

Repair and Service Kits

Plastic bowl / bowl guard, manual drain	<b>P32KB00BGM</b>
Metal bowl / sight gauge, manual drain	<b>P32KB00BSM</b>
Auto drain	<b>P32KA00DA</b>
5µ particle filter element	<b>P32KA00ESE</b>
L-bracket (fits to body)	<b>P32KA00ML</b>
T-bracket (fits to body connector)	<b>P32KA00MB</b>
T-bracket with body connector	<b>P32KA00MT</b>
Body connector	<b>P32KA00CB</b>

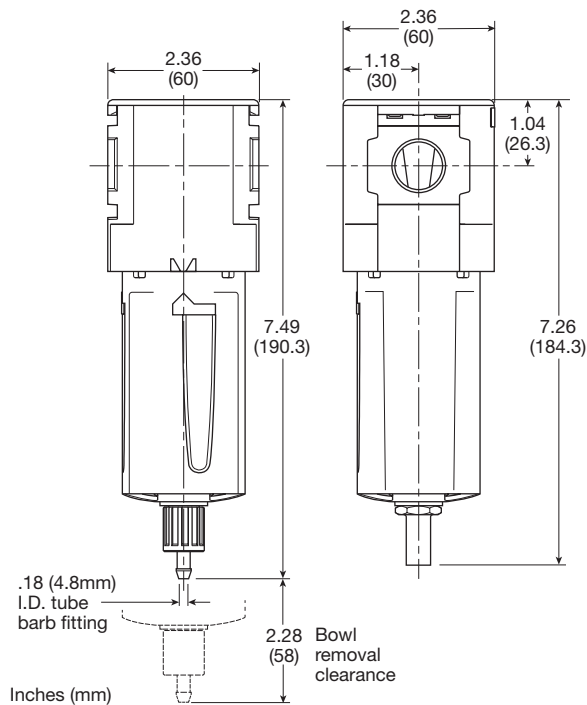

Manual Drain

Automatic Drain

Flow Charts

P32FB 1/4" Filter

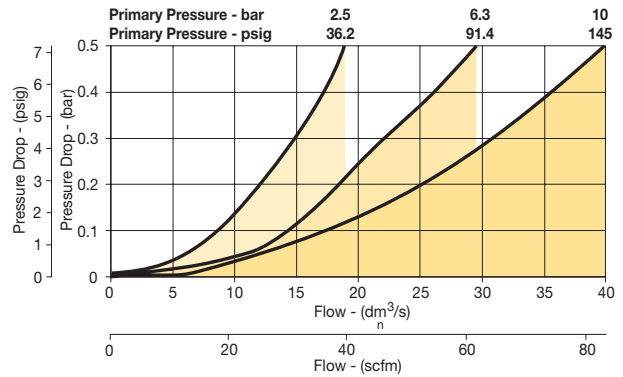

P32FB 3/8" Filter

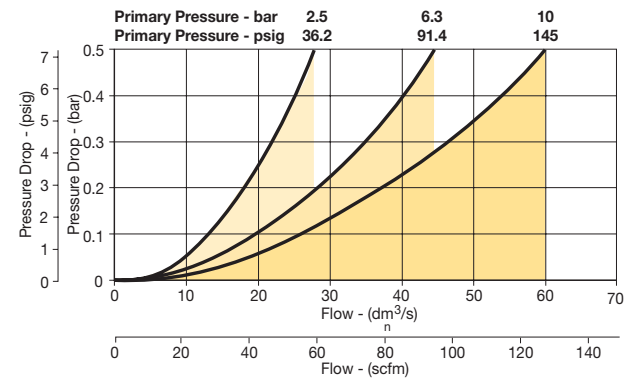

P32FB 1/2" Filter

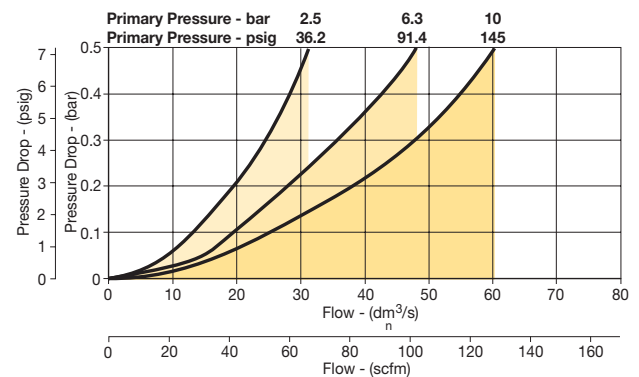

B

Global Air Preparation

Introduction

Filters

Coalescers

Regulators

Filter/Regulators

Lubricators

Combinations

Accessories and Kits



For inventory, lead time, and kit lookup, visit [www.pdnplu.com](http://www.pdnplu.com)

**P33 Particulate Filter – Standard**

- Integral 1/2" or 3/4" ports (NPT, BSPP & BSPT)
- High efficiency 5 micron element as standard
- Excellent water removal efficiency
- Robust but lightweight aluminum construction
- Positive bayonet latch to ensure correct & safe fitting

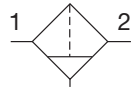

Manual drain

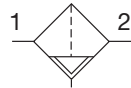

Auto drain

Port size	Description †	Part number
1/2"	Poly bowl, manual drain	<b>P33FA94EGMN</b>
1/2"	Poly bowl, auto drain	<b>P33FA94EGAN</b>
1/2"	Metal bowl, manual drain	<b>P33FA94ESMN</b>
1/2"	Metal bowl, auto drain	<b>P33FA94ESAN</b>
3/4"	Poly bowl, manual drain	<b>P33FA96EGMN</b>
3/4"	Poly bowl, auto drain	<b>P33FA96EGAN</b>
3/4"	Metal bowl, manual drain	<b>P33FA96ESMN</b>
3/4"	Metal bowl, auto drain	<b>P33FA96ESAN</b>

† For polycarbonate bowl, see caution in Engineering Section A.

**Operating information**

Supply pressure (max):	
Plastic bowl	150 psig (10 bar)
Metal bowl	250 psig (17 bar)
Operating temperature:	
Plastic bowl	-13°F to 125°F (-25°C to 52°C)
Metal bowl	-13°F to 150°F (-25°C to 65.5°C)
Standard filtration:	5 micron
Flow capacity*:	1/2 85 scfm (40 dm <sup>3</sup> /s, ANR) 3/4 102 scfm (48 dm <sup>3</sup> /s, ANR)
Useful retention†:	2.8 US oz. (85 cm <sup>3</sup> )
Weight:	1.01 lb (0.46 kg)
* Inlet pressure 91.3 psig (6.3 bar). Pressure drop 4.9 psig (0.34 bar).	
† Useful retention refers to volume below the quiet zone baffle.	

**Air quality:**  
 Within ISO 8573-1: 1991 Class 3 (Particulates)  
 Within ISO 8573-1: 2001 Class 6 (Particulates)

**Ordering Information:**

**P33FA 9 6 E G M N**

<b>Basic series</b> Global modular standard particulate filter P33FA	<b>Thread type</b> BSPP 1 BSPT 2 NPT 9	<b>Port size</b> 1/2 4 3/4 6	<b>Element</b> 5µ Element E	<b>Mounting</b> N No bracket	<b>Drain type</b> M Manual drain A Auto drain	<b>Bowl type</b> G Poly bowl with bowl guard M Metal bowl without sight gauge S Metal bowl with sight gauge
----------------------------------------------------------------------------	-------------------------------------------------	------------------------------------	--------------------------------	---------------------------------	-----------------------------------------------------	----------------------------------------------------------------------------------------------------------------------

Most popular.



For inventory, lead times, and kit lookup, visit [www.pdnplu.com](http://www.pdnplu.com)

**Standard Particulate Filters**

**Material Specifications**

Body	Aluminum
Body cap	ABS
Plastic bowl	Polycarbonate
Metal bowl	Aluminum
Bowl guard	Nylon
Deflector	Polypropylene
Element retainer / Baffle	Acetal
Filter element	Sintered polyethylene
Seals	Nitrile
Sight gauge	Nylon

**Repair and Service Kits**

Plastic bowl / bowl guard, manual drain	<b>P33KA00BGM</b>
Metal bowl / sight gauge, manual drain	<b>P33KA00BSM</b>
Auto drain	<b>P32KA00DA</b>
5µ particle filter element	<b>P33KA00ESE</b>
L-bracket (fits to body)	<b>P33KA00ML</b>
T-bracket (fits to body connector)	<b>P32KA00MB</b>
T-bracket with body connector	<b>P33KA00MT</b>
Body connector	<b>P32KA00CB</b>

**Flow Charts**

**P33FA 1/2" Filter**

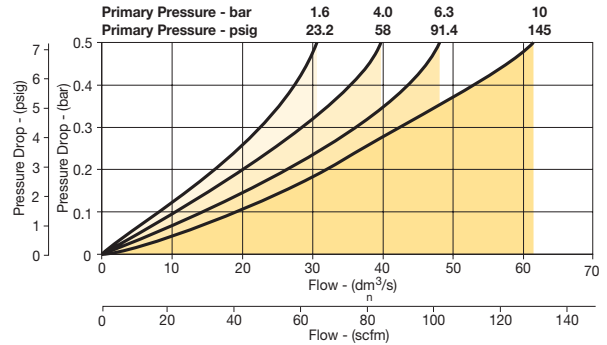

**P33FA 3/4" Filter**

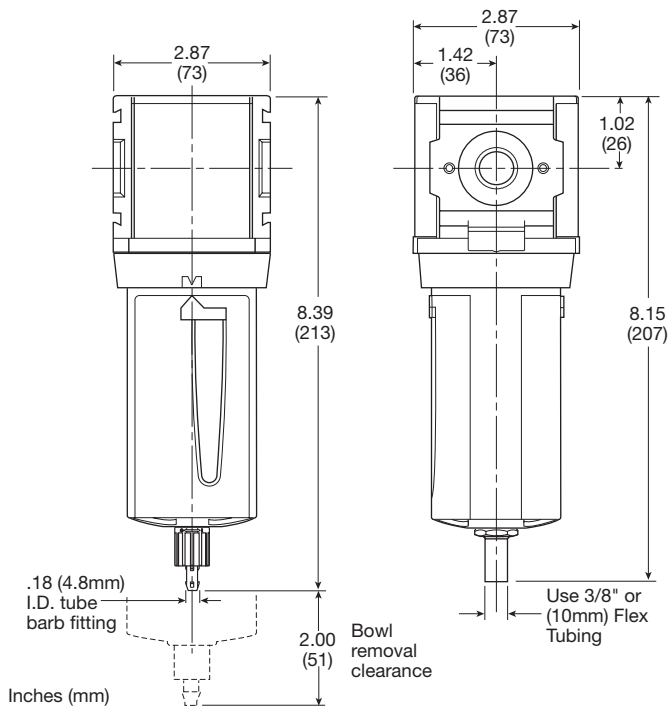
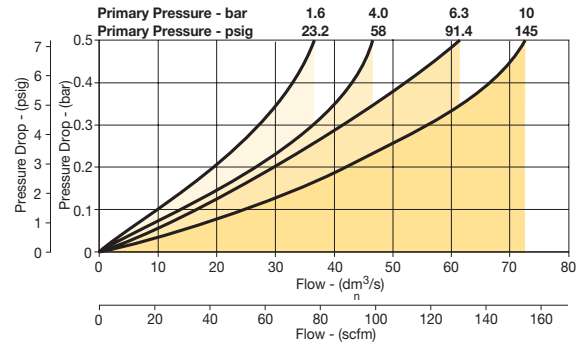

**Manual Drain**

**Automatic Drain**

**B**

Global Air Preparation

Introduction

Filters

Coalescers

Regulators

Filter/Regulators

Lubricators

Combinations

Accessories and Kits



For inventory, lead time, and kit lookup, visit [www.pdnplu.com](http://www.pdnplu.com)

## P31 Coalescing and Adsorber Filters – Mini

- Integral 1/4" ports (NPT, BSPP & BSPT)
- Removes liquid aerosols and sub micron particles
- Oil free air for critical applications, such as air gauging, pneumatic instrumentation and control
- Differential Pressure Indicator (DPI) standard on coalescing filters
- Positive bayonet latch to ensure correct and safe fitting
- Adsorbing activated carbon element removes oil vapors and most hydrocarbons



**Note:** To optimize the life of coalescing element, it is advisable to install a P31F pre-filter with a 5 micron element upstream of the coalescing filter.

To optimize the life of an Adsorber it is advisable to install a P31 Coalescing Filter upstream of the Adsorber. Adsorber element should be replaced approximately every 1000 hours of service.

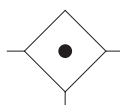

Port size	Description †	Element	Part number
1/4"	Poly bowl, manual drain	0.01 micron	<b>P31FB92DGMN</b>
1/4"	Poly bowl, pulse drain	0.01 micron	<b>P31FB92DGBN</b>
1/4"	Metal bowl, manual drain	0.01 micron	<b>P31FB92DMMN</b>
1/4"	Metal bowl, pulse drain	0.01 micron	<b>P31FB92DMBN</b>

† For polycarbonate bowl, see caution in Engineering Section A.

### Operating information

Supply pressure (max):	
Poly bowl	150 psig (10 bar)
Metal bowl w/ DPI	150 psig (10 bar)
Metal bowl w/o DPI	250 psig (17 bar)
Operating temperature:	
Plastic bowl	14°F to 125°F (-10°C to 52°C)
Metal bowl	14°F to 150°F (-10°C to 65.5°C)
Standard filtration:	1.0 and 0.01 micron
Adsorber	Max. oil carryover (ppm w/w) 0.003 @ 70°F (21°C)
Flow capacity*:	
1.0 micron coalescing	12 scfm (5.5 dm <sup>3</sup> /s, ANR)
0.01 micron coalescing	7.5 scfm (3.6 dm <sup>3</sup> /s, ANR)
Activated carbon adsorber	12.7 scfm (6 dm <sup>3</sup> /s, ANR)
Useful retention†:	0.4 US oz. (12 cm <sup>3</sup> )
Weight:	0.24 lb (0.11 kg)

\* Inlet pressure 91.3 psig (6.3 bar). Pressure drop 3 psig (0.2 bar), saturated element.

† Useful retention refers to volume below the quiet zone baffle.

### Ordering Information:

Basic series	Thread type	Port size	Element	Mounting	Drain type	Bowl type
Global modular mini coalescing filter <b>P31FB</b>	BSPP 1 BSPT 2 NPT 9	1/4 2	0.01µ Element C 0.01µ Element with DPI D 1µ Element 9 1µ Element with DPI Q Adsorber A	N No bracket	B Pulse drain M Manual drain X Flex drain	G Poly bowl with bowl guard M Metal bowl without sight gauge

Most popular.



For inventory, lead times, and kit lookup, visit [www.pdnplu.com](http://www.pdnplu.com)

# Mini Coalescing and Adsorber Filters

## Material Specifications

Body	Aluminum
Body cap	ABS
Plastic bowl	Polycarbonate
Metal bowl	Aluminum
Filter element	Borosilicate cloth
Adsorber element	Activated carbon
Seals	Nitrile

## Repair and Service Kits

Plastic bowl / bowl guard, manual drain	<b>P31KB00BGM</b>
Metal bowl / w/o sight gauge ,manual drain	<b>P31KB00BMM</b>
Plastic bowl / bowl guard, pulse drain	<b>P31KB00BGB</b>
Metal bowl / w/o sight gauge, pulse drain	<b>P31KB00BMB</b>
1µ coalescing filter element	<b>P31KA00ES9</b>
0.01µ coalescing filter element	<b>P31KA00ESC</b>
Activated carbon adsorber filter element	<b>P31KA00ESA</b>
C-bracket (fits to body)	<b>P31KA00MW</b>
T-bracket with body connector	<b>P31KA00MT</b>
Body connector	<b>P31KA00CB</b>
Differential pressure indicator (replacement)	<b>P31KB00RQ</b>

# Air Preparation Products Global Air Preparation

## Flow Charts

**P31FB - 1.0 micron flow**

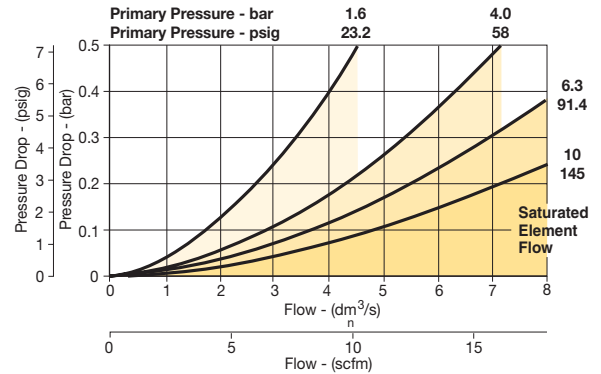

**P31FB - 0.01 micron flow**

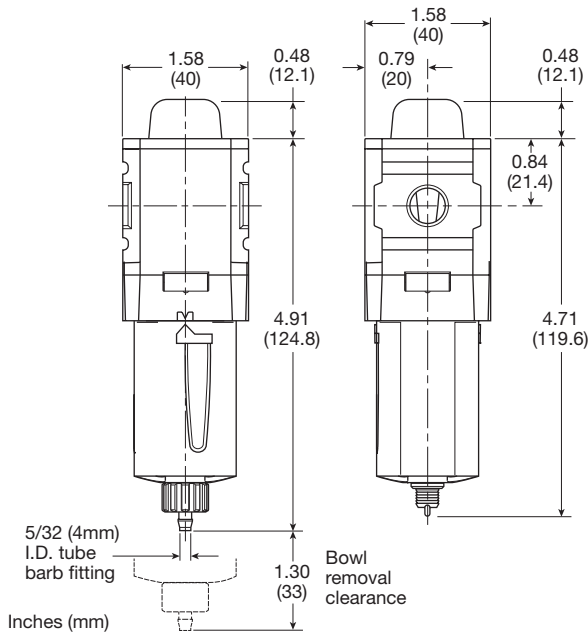
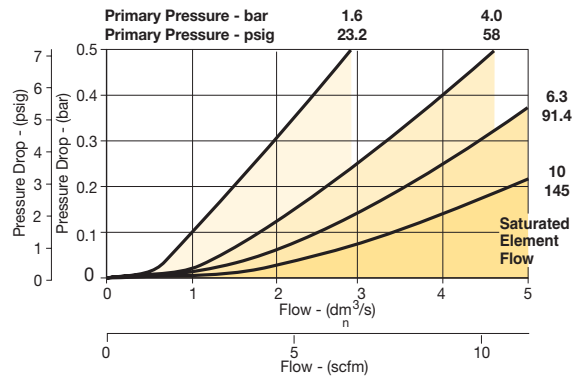

**Manual Drain**

**Pulse Drain**

**B**

Global Air Preparation

Introduction

Filters

Coalescers

Regulators

Filter/Regulators

Lubricators

Combinations

Accessories and Kits



For inventory, lead time, and kit lookup, visit [www.pdnplu.com](http://www.pdnplu.com)

# P32 Coalescing and Adsorber Filters – Compact

- Integral 1/4", 3/8" or 1/2" ports (NPT, BSPP & BSPT)
- Removes liquid aerosols and sub micron particles
- Oil free air for critical applications, such as air gauging, pneumatic instrumentation and control
- Differential Pressure Indicator (DPI) standard on Coalescing Filters
- Positive bayonet latch to ensure correct & safe fitting
- Adsorbing activated carbon element removes oil vapors and most hydrocarbons

**Note:** To optimize the life of coalescing element, it is advisable to install a P32F pre-filter with a 5 micron element upstream of the coalescing filter. To optimize the life of an Adsorber it is advisable to install a P32 Coalescing Filter upstream of the Adsorber. Adsorber element should be replaced approximately every 1000 hours of service.



Port size	Description †	Element	Part number
1/4"	Poly bowl, manual drain	0.01 micron	<b>P32FB92DGMN</b>
1/4"	Poly bowl, auto drain	0.01 micron	<b>P32FB92DGAN</b>
1/4"	Metal bowl, manual drain	0.01 micron	<b>P32FB92DSMN</b>
1/4"	Metal bowl, auto drain	0.01 micron	<b>P32FB92DSAN</b>
3/8"	Poly bowl, manual drain	0.01 micron	<b>P32FB93DGMN</b>
3/8"	Poly bowl, auto drain	0.01 micron	<b>P32FB93DGAN</b>
3/8"	Metal bowl, manual drain	0.01 micron	<b>P32FB93DSMN</b>
3/8"	Metal bowl, auto drain	0.01 micron	<b>P32FB93DSAN</b>
1/2"	Poly bowl, manual drain	0.01 micron	<b>P32FB94DGMN</b>
1/2"	Poly bowl, auto drain	0.01 micron	<b>P32FB94DGAN</b>
1/2"	Metal bowl, manual drain	0.01 micron	<b>P32FB94DSMN</b>
1/2"	Metal bowl, auto drain	0.01 micron	<b>P32FB94DSAN</b>

† For polycarbonate bowl, see caution in Engineering Section A.

## Operating information

Supply pressure (max):	
Poly bowl	150 psig (10 bar)
Metal bowl w/ DPI	150 psig (10 bar)
Metal bowl w/o DPI	250 psig (17 bar)
Operating temperature:	
Plastic bowl	-13°F to 125°F (-25°C to 52°C)
Metal bowl	-13°F to 150°F (-25°C to 65.5°C)
Standard filtration:	1.0 and 0.01 micron
Adsorber	Max. oil carryover (ppm w/w) 0.003 @ 70°F (21°C)
Flow capacity*:	
1.0 micron coalescing	53 scfm (25 dm³/s, ANR)
0.01 micron coalescing	36 scfm (17 dm³/s, ANR)
Activated carbon adsorber	85 scfm (40 dm³/s, ANR)
Useful retention†:	1.7 US oz. (51 cm³)
Weight:	0.71 lb (0.32 kg)

\* Inlet pressure 91.3 psig (6.3 bar). Pressure drop 3 psig (0.2 bar), saturated element.

† Useful retention refers to volume below the quiet zone baffle.

## Ordering Information:

<b>P32FB</b>		<b>9</b>	<b>2</b>	<b>D</b>	<b>G</b>	<b>M</b>	<b>N</b>
<b>Basic series</b> Global modular compact coalescing filter P32FB		<b>Thread type</b> BSPP 1 BSPT 2 NPT 9	<b>Port size</b> 1/4 2 3/8 3 1/2 4	<b>Element</b> 0.01µ Element C 0.01µ Element with DPI D 1µ Element 9 1µ Element with DPI Q Adsorber A	<b>Mounting</b> N No bracket		
				<b>Drain type</b> M Manual drain A Auto drain X Flex drain		<b>Bowl type</b> G Poly bowl with bowl guard M Metal bowl without sight gauge S Metal bowl with sight gauge	

Most popular.



For inventory, lead times, and kit lookup, visit [www.pdnplu.com](http://www.pdnplu.com)



**Material Specifications**

Body	Aluminum
Body cap	ABS
Plastic bowl	Polycarbonate
Metal bowl	Aluminum
Filter element	Borosilicate cloth
Adsorber	Activated carbon
Seals	Nitrile
Sight gauge	Nylon

**Repair and Service Kits**

Plastic bowl / bowl guard, manual drain	<b>P32KB00BGM</b>
Metal bowl / sight gauge, manual drain	<b>P32KB00BSM</b>
Auto drain	<b>P32KA00DA</b>
1µ coalescing filter element	<b>P32KA00ES9</b>
0.01µ coalescing filter element	<b>P32KA00ESC</b>
Activated carbon adsorber filter element	<b>P32KA00ESA</b>
L-bracket (fits to body)	<b>P32KA00ML</b>
T-bracket (fits to body connector)	<b>P32KA00MB</b>
T-bracket with body connector	<b>P32KA00MT</b>
Body connector	<b>P32KA00CB</b>
Differential pressure indicator (replacement)	<b>P32KA00RQ</b>

**Flow Charts**

**P32FB - 1.0 micron flow**

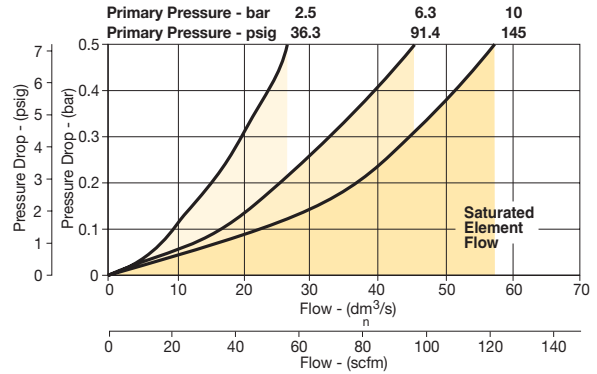

**P32FB - 0.01 micron flow**

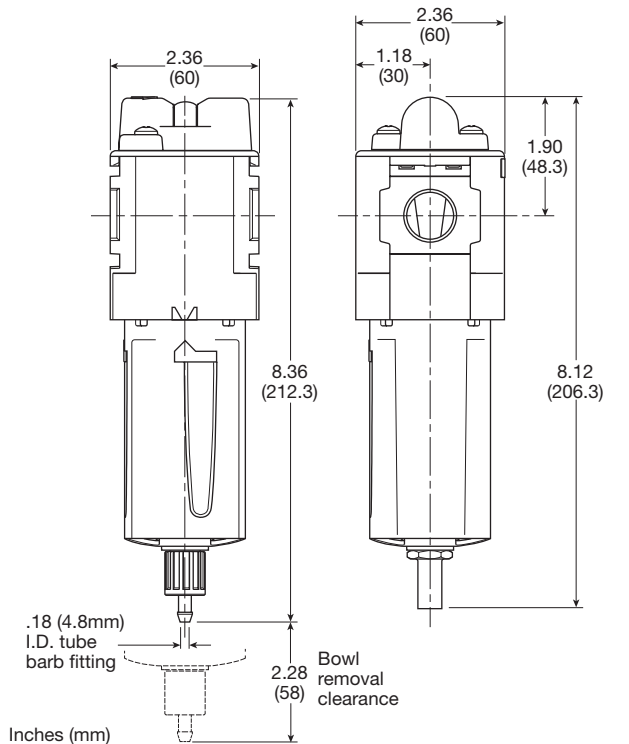
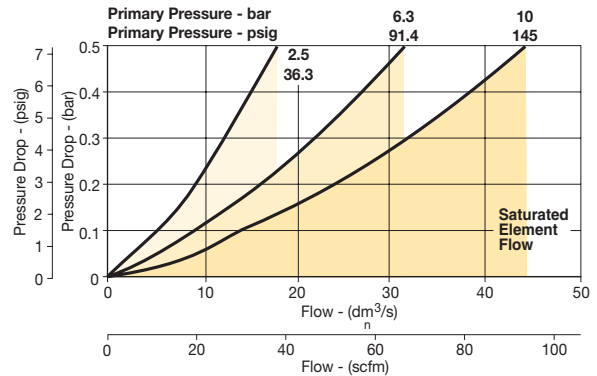

**Manual Drain**

**Automatic Drain**

B
Global Air Preparation
Introduction
Filters
Coalescers
Regulators
Filter/Regulators
Lubricators
Combinations
Accessories and Kits



For inventory, lead time, and kit lookup, visit [www.pdnplu.com](http://www.pdnplu.com)

# P33 Coalescing and Adsorber Filters – Standard

- Integral 1/2" or 3/4" ports (NPT, BSPP & BSPT)
- Removes liquid aerosols and sub micron particles
- Oil free air for critical applications, such as air gauging, pneumatic instrumentation and control
- Differential Pressure Indicator (DPI) standard on Coalescing Filters
- Positive bayonet latch to ensure correct & safe fitting
- Adsorbing activated carbon element removes oil vapors and most hydrocarbons



**Note:** To optimize the life of coalescing element, it is advisable to install a P33F pre-filter with a 5 micron element upstream of the coalescing filter.

To optimize the life of an Adsorber it is advisable to install a P33 Coalescing Filter upstream of the Adsorber. Adsorber element should be replaced approximately every 1000 hours of service.

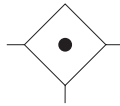

Port size	Description †	Element	Part number
1/2"	Poly bowl, manual drain	0.01 micron	<b>P33FA94DGMN</b>
1/2"	Poly bowl, auto drain	0.01 micron	<b>P33FA94DGAN</b>
1/2"	Metal bowl, manual drain	0.01 micron	<b>P33FA94DSMN</b>
1/2"	Metal bowl, auto drain	0.01 micron	<b>P33FA94DSAN</b>
3/4"	Poly bowl, manual drain	0.01 micron	<b>P33FA96DGMN</b>
3/4"	Poly bowl, auto drain	0.01 micron	<b>P33FA96DGAN</b>
3/4"	Metal bowl, manual drain	0.01 micron	<b>P33FA96DSMN</b>
3/4"	Metal bowl, auto drain	0.01 micron	<b>P33FA96DSAN</b>

† For polycarbonate bowl, see caution in Engineering Section A.

## Operating information

Supply pressure (max):	
Poly bowl	150 psig (10 bar)
Metal bowl w/ DPI	150 psig (10 bar)
Metal bowl w/o DPI	250 psig (17 bar)
Operating temperature:	
Plastic bowl	-13°F to 125°F (-25°C to 52°C)
Metal bowl	-13°F to 150°F (-25°C to 65.6°C)
Standard filtration:	1.0 and 0.01 micron
Adsorber	Max. oil carryover (ppm w/w) 0.003 @ 70°F (21°C)
Flow capacity*:	
1.0 micron coalescing	68 scfm (32 dm³/s, ANR)
0.01 micron coalescing	42 scfm (20 dm³/s, ANR)
Activated carbon adsorber	72 scfm (34 dm³/s, ANR)
Useful retention†:	2.8 US oz. (85 cm³)
Weight:	1.10 lb (0.50 kg)

\* Inlet pressure 91.3 psig (6.3 bar). Pressure drop 3 psig (0.2 bar), saturated element.

† Useful retention refers to volume below the quiet zone baffle.

## Ordering information:

P33FA 9 6 D G M N

**Basic series**

Global modular standard coalescing filter

P33FA

**Thread type**

BSPP 1

BSPT 2

NPT 9

**Port size**

1/2 4

3/4 6

**Element**

0.01µ Element C

0.01µ Element with DPI D

1µ Element 9

1µ Element with DPI Q

Adsorber A

**Drain type**

M Manual drain

A Auto drain

**Bowl type**

G Poly bowl with bowl guard

M Metal bowl without sight gauge

S Metal bowl with sight gauge

**Mounting**

N No bracket

Most popular.



For inventory, lead times, and kit lookup, visit [www.pdnplu.com](http://www.pdnplu.com)

# Standard Coalescing and Adsorber Filters

# Air Preparation Products Global Air Preparation

## Material Specifications

Body	Aluminum
Body cap	ABS
Plastic bowl	Polycarbonate
Metal bowl	Aluminum
Filter element	Borosilicate cloth
Adsorber	Activated carbon
Seals	Nitrile
Sight gauge	Nylon

## Repair and Service Kits

Plastic bowl / bowl guard, manual drain	<b>P33KA00BGM</b>
Metal bowl / sight gauge, manual drain	<b>P33KA00BSM</b>
Auto drain	<b>P32KA00DA</b>
1µ coalescing filter element	<b>P33KA00ES9</b>
0.01µ coalescing filter element	<b>P33KA00ESC</b>
Activated carbon adsorber filter element	<b>P33KA00ESA</b>
L-bracket (fits to body)	<b>P33KA00ML</b>
T-bracket (fits to body connector)	<b>P32KA00MB</b>
T-bracket with body connector	<b>P32KA00MT</b>
Body connector	<b>P32KA00CB</b>
Differential pressure indicator (replacement)	<b>P32KA00RQ</b>

## Flow Charts

**P33FA - 1.0 micron flow**

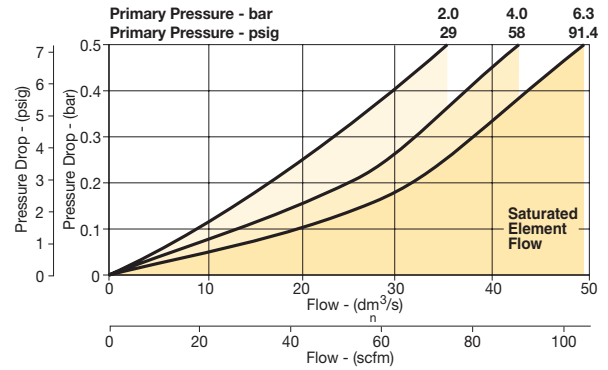

**P33FA - 0.01 micron flow**

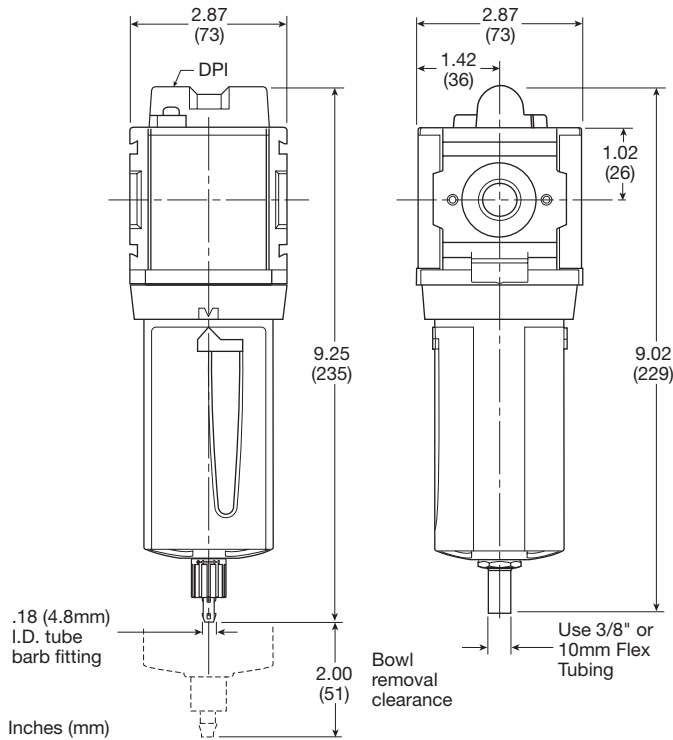
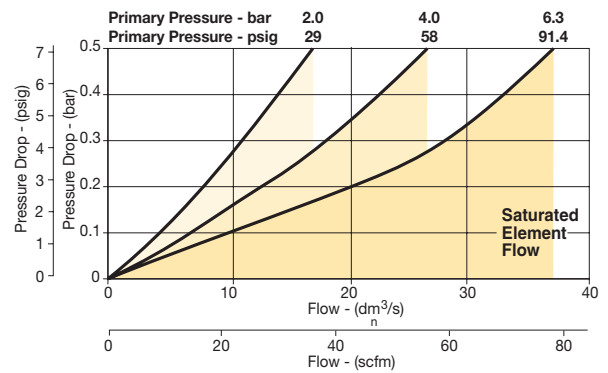

Manual Drain

Automatic Drain

**B**

Global Air Preparation

Introduction

Filters

Coalescers

Regulators

Filter/Regulators

Lubricators

Combinations

Accessories and Kits



For inventory, lead time, and kit lookup, visit [www.pdnplu.com](http://www.pdnplu.com)

## P31 Regulators – Mini

- Integral 1/4" ports (NPT, BSPP & BSPT)
- Robust but lightweight aluminum construction
- Secondary pressure ranges
- Secondary aspiration plus balanced poppet provides quick response and accurate pressure regulation.
- Relieving & non-relieving types
- Non-rising knob

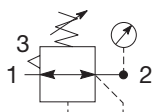

Self relieving regulator with gauge

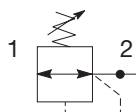

Non-relieving regulator

### Operating information

Flow capacity*:	1/4	68 scfm (32 dm <sup>3</sup> /s, ANR)
Operating temperature†:		-4°F to 150°F (-20°C to 65.5°C)
Supply pressure (max):		300 psig (20 bar)
Adjusting range pressure:		30 psig (0-2 bar) 60 psig (0-4 bar) 125 psig (0-8 bar) 232 psig (0-16 bar)
Gauge port (2 each)**:		1/8 BSPP, BSPT, NPT
Weight:		0.37 lb (0.17 kg)

\* Inlet pressure 145 psig (10 bar). Secondary pressure 91.3 psig (6.3 bar) and 14.5 psig (1 bar) pressure drop.

\*\* Non-gauge option only.

† Units with square gauges: 5°F to 150°F (-15°C to 65.5°C)

Port size	Description (relieving)	Gauge	Part number
1/4"	125 psig (8 bar)	None	<b>P31RB92BNNP</b>
1/4"	125 psig (8 bar)	Square	<b>P31RB92BN5P</b>

### Ordering Information:

<b>P31RB</b>		<b>9</b>	<b>2</b>	<b>B</b>	<b>N</b>	<b>5</b>	<b>P</b>
<b>Basic series</b> Global modular mini regulator P31RB		<b>Thread type</b> BSPP 1 BSPT 2 NPT 9		<b>Port size</b> 1/4 2		<b>Mounting</b> P Plastic panel mount nut	
		<b>Relief</b> Relieving B Non-relieving N Reverse flow-relieving R		<b>Adjustment range</b>			
				<b>Adjustment</b> N Non-rising knob			
						<b>Without gauge</b>	
						Y 30 psig; 2 bar; 0.2 MPa	
						L 60 psig; 4 bar; 0.4 MPa	
						N 125 psig; 8 bar; 0.8 MPa	
						H 232 psig; 16 bar; 1.6 MPa	

\* Regulator comes with gauge respective to the adjustment range selected.

Most popular.



For inventory, lead times, and kit lookup, visit [www.pdnplu.com](http://www.pdnplu.com)

**Material Specifications**

Body	Aluminum
Adjustment knob	Acetal
Bonnet	PBT
Diaphragm assembly	Brass / Nitrile
Valve assembly	Brass / Nitrile
Springs	Steel
Seals	Nitrile
Panel nut	Acetal

**Repair and Service Kits**

Diaphragm repair kit - relieving	<b>P31KB00RB</b>
Diaphragm repair kit - non-relieving	<b>P31KB00RC</b>
Panel mount nut - aluminum	<b>P31KA00MM</b>
Panel mount nut - plastic	<b>P31KA00MP</b>
Angle bracket (attaches via panel nut)	<b>P31KB00MR</b>
C-bracket (fits to body)	<b>P31KA00MW</b>
T-bracket with body connector	<b>P31KA00MT</b>
Body connector	<b>P31KA00CB</b>

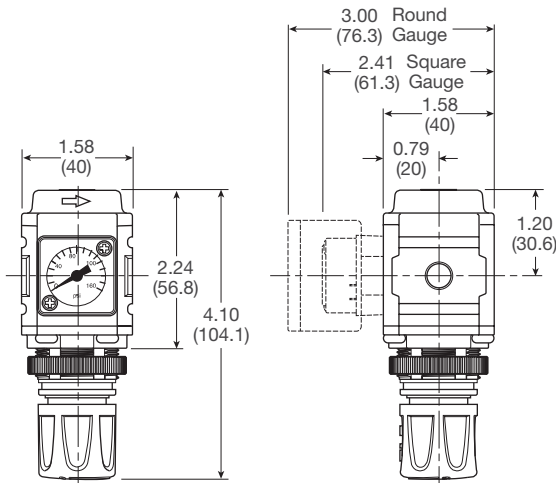

Inches (mm)

**NOTE:** 1.20 in. (30mm) hole required for panel nut mounting.

**Flow Charts**

**P31RB 1/4" Regulator**

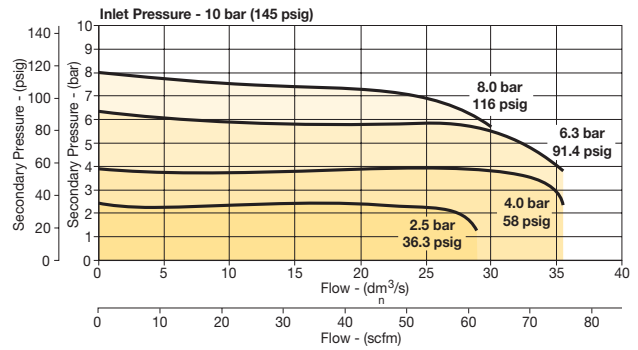

**⚠ WARNING**

**Product rupture can cause serious injury.  
 Do not connect regulator to bottled gas.  
 Do not exceed Maximum primary pressure rating.**

**CAUTION:**

**REGULATOR PRESSURE ADJUSTMENT** – The working range of knob adjustment is designed to permit outlet pressures within their full range. Pressure adjustment beyond this range is also possible because the knob is not a limiting device. This is a common characteristic of most industrial regulators, and limiting devices may be obtained only by special design. For best performance, regulated pressure should always be set by increasing the pressure up to the desired setting.

**Gauges**

<b>Square flush mount gauge</b>	0-4 bar	<b>K4511SCR04B</b>
	0-11 bar	<b>K4511SCR11B</b>
	0-60 psig	<b>K4511SCR060</b>
	0-160 psig	<b>K4511SCR160</b>
<b>Square with adapter kit</b>	0-4 bar	<b>P6G-PR10040</b>
	0-11 bar	<b>P6G-PR10110</b>
	0-60 psig	<b>P6G-PR90060</b>
	0-160 psig	<b>P6G-PR90160</b>
<b>1.00" Round 1/8" center back mount</b>	0-60 psig / 0-4 bar	<b>K4510N18060</b>
	0-160 psig / 0-11 bar	<b>K4510N18160</b>
<b>40mm Round 1/8" center back mount</b> (Not for use with common port regulators)	0-30 psig / 0-2 bar	<b>K4515N18030</b>
	0-60 psig / 0-4 bar	<b>K4515N18060</b>
	0-160 psig / 0-11 bar	<b>K4515N18160</b>

For best performance, regulated pressure should always be set by increasing the pressure up to the desired setting.

**B**

Global Air Preparation

Introduction

Filters

Coalescers

Regulators

Filter/Regulators

Lubricators

Combinations

Accessories and Kits



For inventory, lead time, and kit lookup, visit [www.pdnplu.com](http://www.pdnplu.com)

## P31 Common P1 Regulators – Mini

- Manifold style regulator with line pressure on both sides
- Pressure output is at front or rear
- Inlet port 1/4" (NPT, BSPP & BSPT)
- Working port 1/8"
- Robust construction
- Secondary pressure ranges
- Secondary aspiration plus balanced poppet provides quick response and accurate pressure regulation
- Relieving & non-relieving types
- Non-rising knob

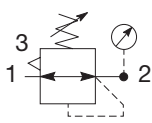
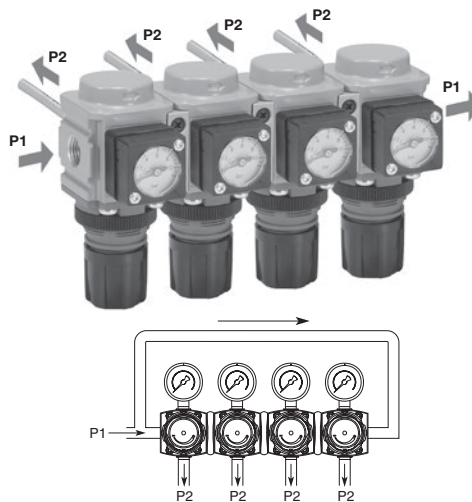

Self relieving regulator with gauge

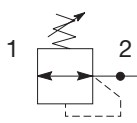

Non-relieving regulator

Port size	Description (relieving)	Gauge	Part number
1/4"	125 psig (8 bar)	None	<b>P31HB92BNNP</b>
1/4"	125 psig (8 bar)	Square	<b>P31HB92BN5P</b>

### Operating information

Flow capacity*:	1/4	42 scfm (20 dm <sup>3</sup> /s, ANR)
Operating temperature:		-4°F to 150°F (-20°C to 65.5°C)
Supply pressure (max):		300 psig (20 bar)
Adjusting range pressure:		30 psig (0-2 bar) 60 psig (0-4 bar) 125 psig (0-8 bar) 232 psig (0-16 bar)
P1 port size (inlet/outlet)		1/4 NPT, BSPP, BSPT
P2 regulated ports (2 ea.)		1/8 NPT, BSPP, BSPT
Weight:		0.66 lb (0.30 kg)

\* Inlet pressure 145 psig (10 bar). Secondary pressure 91.3 psig (6.3 bar) and 14.5 psig (1 bar) pressure drop.

### Ordering Information:

**P31HB 9 2 B N 5 P**

<b>Basic series</b> Global modular mini common regulator P31HB	<b>Thread type</b> BSPP 1 BSPT 2 NPT 9	<b>Port size †</b> 1/4 2 † Working port 1/8".	<b>Relief</b> Relieving B Non-relieving N Reverse flow-relieving R	<b>Mounting</b> P Plastic panel mount nut
----------------------------------------------------------------------	-------------------------------------------------	-----------------------------------------------------	-----------------------------------------------------------------------------	----------------------------------------------

With square gauge		Adjustment range	
psig	bar	With round gauge	
1 = 30*	V = 2*	Z	30 psig; 2 bar; 0.2 MPa
3 = 60	S = 4	M	60 psig; 4 bar; 0.4 MPa
5 = 125	T = 8	G	125 psig; 8 bar; 0.8 MPa
		J	232 psig; 16 bar; 1.6 MPa
		Without gauge	
		Y	30 psig; 2 bar; 0.2 MPa
		L	60 psig; 4 bar; 0.4 MPa
		N	125 psig; 8 bar; 0.8 MPa
		H	232 psig; 16 bar; 1.6 MPa

\* Regulator comes with gauge respective to the adjustment range selected.

<b>Adjustment</b> N Non-rising knob
----------------------------------------

Most popular.



For inventory, lead times, and kit lookup, visit [www.pdnplu.com](http://www.pdnplu.com)

## Mini Common P1 Regulators

### Materials of Construction

Body	Aluminum
Adjustment knob	Acetal
Bonnet	Glass-filled PBT
Diaphragm assembly	Brass / Nitrile
Valve assembly	Brass / Nitrile

### Repair and Service Kits

Diaphragm repair kit - relieving	<b>P31KB00RB</b>
Diaphragm repair kit - non-relieving	<b>P31KB00RC</b>
Panel mount nut - aluminum	<b>P31KA00MM</b>
Panel mount nut - plastic	<b>P31KA00MP</b>
Angle bracket (attaches via panel nut)	<b>P31KB00MR</b>
T-bracket with body connector	<b>P31KA00MT</b>
Body connector	<b>P31KA00CB</b>

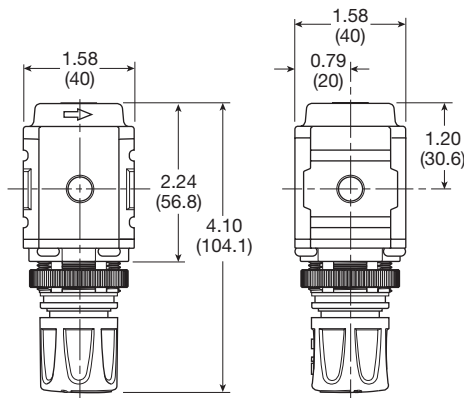

Inches (mm)

**NOTE:** 1.20 in. (30mm) hole required for panel nut mounting.

## Air Preparation Products Global Air Preparation

### Flow Charts

#### P31HB 1/4" Common Regulator

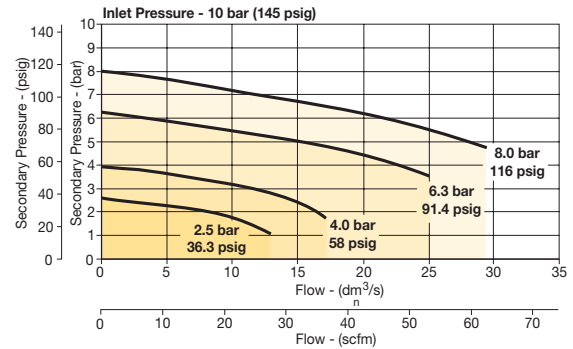

**WARNING**  
Product rupture can cause serious injury.  
Do not connect regulator to bottled gas.  
Do not exceed Maximum primary pressure rating.

### CAUTION:

**REGULATOR PRESSURE ADJUSTMENT** – The working range of knob adjustment is designed to permit outlet pressures within their full range. Pressure adjustment beyond this range is also possible because the knob is not a limiting device. This is a common characteristic of most industrial regulators, and limiting devices may be obtained only by special design. For best performance, regulated pressure should always be set by increasing the pressure up to the desired setting.

### Gauges

Square with adapter kit	0-4 bar	<b>P6G-PR10040</b>
	0-11 bar	<b>P6G-PR10110</b>
	0-60 psig	<b>P6G-PR90060</b>
	0-160 psig	<b>P6G-PR90160</b>
1.00" round 1/8" center back mount	0-60 psig / 0-4 bar	<b>K4510N18060</b>
	0-160 psig / 0-11 bar	<b>K4510N18160</b>

For best performance, regulated pressure should always be set by increasing the pressure up to the desired setting.

**B**

Global Air Preparation

Introduction

Filters

Coalescers

Regulators

Filter/Regulators

Lubricators

Combinations

Accessories and Kits



For inventory, lead time, and kit lookup, visit [www.pdnplu.com](http://www.pdnplu.com)

## P32 Regulators – Compact

- Integral 1/4", 3/8" or 1/2" ports (NPT, BSPP & BSPT)
- Robust but lightweight aluminum construction
- Secondary pressure ranges
- Secondary aspiration plus balanced poppet provides quick response and accurate pressure regulation
- Relieving & non-relieving types
- Regulator will reverse flow as standard
- Non-rising knob
- Available T-handle

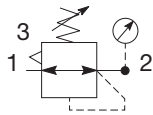

Self relieving regulator with gauge

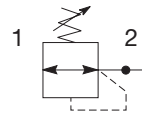

Non-relieving regulator

Port size	Description (relieving)	Gauge	Part number
1/4"	125 psig (8 bar)	None	<b>P32RB92BNNP</b>
1/4"	125 psig (8 bar)	Round	<b>P32RB92BNGP</b>
3/8"	125 psig (8 bar)	None	<b>P32RB93BNNP</b>
3/8"	125 psig (8 bar)	Round	<b>P32RB93BNGP</b>
1/2"	125 psig (8 bar)	None	<b>P32RB94BNNP</b>
1/2"	125 psig (8 bar)	Round	<b>P32RB94BNGP</b>

### Operating information

Flow capacity*:	
1/4	148 scfm (70 dm <sup>3</sup> /s, ANR)
3/8, 1/2	165 scfm (78 dm <sup>3</sup> /s, ANR)
Operating temperature:	-13°F to 150°F (-25°C to 65.5°C)
Supply pressure (max):	300 psig (20 bar)
Adjusting range pressure:	30 psig (0-2 bar) 60 psig (0-4 bar) 125 psig (0-8 bar) 250 psig (0-17 bar)
Gauge port (2 each)	1/4 NPT, BSPP, BSPT
Weight:	0.90 lb (0.41 kg)
* Inlet pressure 145 psig (10 bar). Secondary pressure 91.3 psig (6.3 bar) and 14.5 psig (1 bar) pressure drop.	

### Ordering Information:

<b>P32RB</b>		<b>9</b>	<b>2</b>	<b>B</b>	<b>N</b>	<b>G</b>	<b>P</b>
<b>Basic series</b> Global modular compact regulator P32RB		<b>Thread type</b> BSPP 1 BSPT 2 NPT 9	<b>Port size</b> 1/4 2 3/8 3 1/2 4	<b>Relief</b> Relieving B Non-relieving N	<b>Mounting</b> P Plastic panel mount nut		
				<b>Adjustment range</b>		<b>Adjustment</b>	
				* Regulator comes with gauge respective to the adjustment range selected.		Without gauge	
				With square gauge		With round gauge	
				psig      bar		Z      30 psig; 2 bar; 0.2 MPa	
				1 = 30*      V = 2*		M      60 psig; 4 bar; 0.4 MPa	
				3 = 60      S = 4		G      125 psig; 8 bar; 0.8 MPa	
				5 = 125      T = 8		J      250 psig; 17 bar; 1.7 MPa	
				<b>N</b> Non-rising knob		Y      30 psig; 2 bar; 0.2 MPa	
				<b>T</b> T-Handle		L      60 psig; 4 bar; 0.4 MPa	
						N      125 psig; 8 bar; 0.8 MPa	
						H      250 psig; 17 bar; 1.7 MPa	

Most popular.



For inventory, lead times, and kit lookup, visit [www.pdnplu.com](http://www.pdnplu.com)



**Material Specifications**

Body	Aluminum
Adjustment knob	Acetal
Bonnet	Glass-filled nylon
Diaphragm assembly	Nitrile / Zinc
Valve assembly	Brass / Nitrile
Springs	Steel, stainless steel
Seals	Nitrile
Panel nut	Acetal

**Repair and Service Kits**

Diaphragm repair kit - relieving	<b>P32KB00RB</b>
Diaphragm repair kit - non-relieving	<b>P32KB00RC</b>
Panel mount nut - aluminum	<b>P32KA00MM</b>
Panel mount nut - plastic	<b>P32KA00MP</b>
Angle bracket (attaches via panel nut)	<b>P32KB00MR</b>
T-bracket with body connector	<b>P32KA00MT</b>
T-bracket	<b>P32KA00MB</b>
Body connector	<b>P32KA00CB</b>

**WARNING**

**Product rupture can cause serious injury.  
 Do not connect regulator to bottled gas.  
 Do not exceed Maximum primary pressure rating.**

**CAUTION:**

**REGULATOR PRESSURE ADJUSTMENT** – The working range of knob adjustment is designed to permit outlet pressures within their full range. Pressure adjustment beyond this range is also possible because the knob is not a limiting device. This is a common characteristic of most industrial regulators, and limiting devices may be obtained only by special design. For best performance, regulated pressure should always be set by increasing the pressure up to the desired setting.

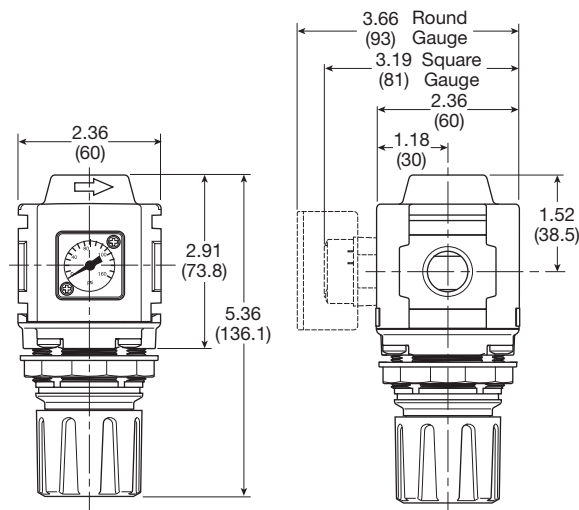

Inches (mm)

**NOTE:** 1.90 in. (48mm) hole required for panel nut mounting.

**Flow Charts**

**P32RB 1/4" Regulator**

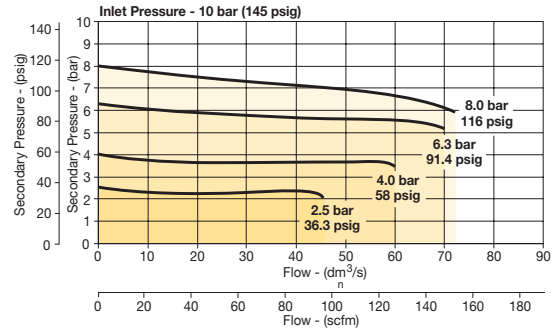

**P32RB 3/8" Regulator**

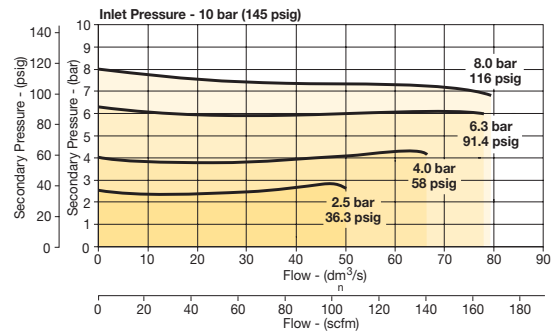

**P32RB 1/2" Regulator**

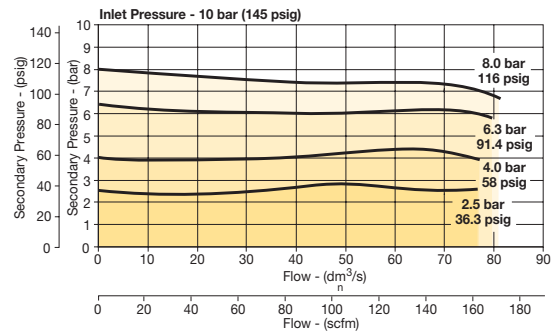

**Gauges**

Square flush mount gauge	0-4 bar	<b>K4511SCR04B</b>
	0-11 bar	<b>K4511SCR11B</b>
	0-60 psig	<b>K4511SCR060</b>
	0-160 psig	<b>K4511SCR160</b>
Square with adapter kit	0-4 bar	<b>P6G-PR10040</b>
	0-11 bar	<b>P6G-PR10110</b>
	0-60 psig	<b>P6G-PR90060</b>
	0-160 psig	<b>P6G-PR90160</b>
50mm (2") round 1/4" center back mount	0-30 psig / 0-2 bar	<b>K4520N14030</b>
	0-60 psig / 0-4 bar	<b>K4520N14060</b>
	0-160 psig / 0-11 bar	<b>K4520N14160</b>
	0-300 psig / 0-20 bar	<b>K4520N14300</b>

For best performance, regulated pressure should always be set by increasing the pressure up to the desired setting.



For inventory, lead time, and kit lookup, visit [www.pdnplu.com](http://www.pdnplu.com)

**Compact Semi-Precision Regulators**

**P32 Semi-Precision Regulator – Compact**

- Integral 1/4", 3/8" or 1/2" ports (NPT, BSPP & BSPT)
- Robust but lightweight aluminum construction
- Secondary pressure ranges
- Secondary aspiration plus balanced poppet provides quick response and accurate pressure regulation
- Relieving & non-relieving types
- Regulator will reverse flow as standard
- Non-rising knob

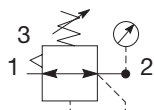

Self relieving regulator with gauge

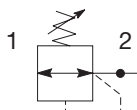

Non-relieving regulator

Port size	Description (relieving)	Gauge	Part number
1/4"	125 psig (8 bar)	None	<b>P32RB92PNNP</b>
1/4"	125 psig (8 bar)	Round	<b>P32RB92PNGP</b>
3/8"	125 psig (8 bar)	None	<b>P32RB93PNNP</b>
3/8"	125 psig (8 bar)	Round	<b>P32RB93PNGP</b>
1/2"	125 psig (8 bar)	None	<b>P32RB94PNNP</b>
1/2"	125 psig (8 bar)	Round	<b>P32RB94PNGP</b>

**Operating information**

Flow capacity*:	53 scfm (25 dm <sup>3</sup> /s, ANR)
Effect of supply pressure variation:	0.6 psig (0.04 bar) for 25 psig (1.7 bar) change in P1
Operating temperature:	-13°F to 150°F (-25°C to 65.5°C)
Supply pressure (max):	300 psig (20 bar)
Adjusting range pressure:	0 to 30 psig (0 to 2 bar) 0 to 60 psig (0 to 4 bar) 0 to 125 psig (0 to 8 bar) 0 to 250 psig (0 to 17 bar)
Gauge port (2 each):	1/4 NPT, BSPP, BSPT
Weight:	0.90 lb (0.41 kg)

\* Inlet pressure 145 psig (10 bar). Secondary pressure 91.3 psig (6.3 bar) and 14.5 psig (1 bar) pressure drop.

**Ordering Information:**

**P32RB 9 2 P N G P**

<b>Basic series</b> Global modular compact regulator P32RB	<b>Thread type</b> BSPP 1 BSPT 2 NPT 9	<b>Port size</b> 1/4 2 3/8 3 1/2 4	<b>Relief</b> Semi-precision relieving P Semi-precision non-relieving N	<b>Mounting</b> P Plastic panel mount nut	<b>Adjustment range</b>																				
					<table border="1"> <thead> <tr> <th colspan="2">With square gauge</th> <th colspan="2">With round gauge</th> </tr> <tr> <th>psig</th> <th>bar</th> <th>Z</th> <th>M</th> </tr> </thead> <tbody> <tr> <td>1 = 30*</td> <td>V = 2*</td> <td>30 psig; 2 bar; 0.2 MPa</td> <td>60 psig; 4 bar; 0.4 MPa</td> </tr> <tr> <td>3 = 60</td> <td>S = 4</td> <td>G</td> <td>J</td> </tr> <tr> <td>5 = 125</td> <td>T = 8</td> <td>125 psig; 8 bar; 0.8 MPa</td> <td>250 psig; 17 bar; 1.7 MPa</td> </tr> </tbody> </table>	With square gauge		With round gauge		psig	bar	Z	M	1 = 30*	V = 2*	30 psig; 2 bar; 0.2 MPa	60 psig; 4 bar; 0.4 MPa	3 = 60	S = 4	G	J	5 = 125	T = 8	125 psig; 8 bar; 0.8 MPa	250 psig; 17 bar; 1.7 MPa
With square gauge		With round gauge																							
psig	bar	Z	M																						
1 = 30*	V = 2*	30 psig; 2 bar; 0.2 MPa	60 psig; 4 bar; 0.4 MPa																						
3 = 60	S = 4	G	J																						
5 = 125	T = 8	125 psig; 8 bar; 0.8 MPa	250 psig; 17 bar; 1.7 MPa																						
					<table border="1"> <thead> <tr> <th colspan="2">Without gauge</th> </tr> <tr> <th>Y</th> <th>L</th> </tr> </thead> <tbody> <tr> <td>30 psig; 2 bar; 0.2 MPa</td> <td>60 psig; 4 bar; 0.4 MPa</td> </tr> <tr> <td>N</td> <td>H</td> </tr> <tr> <td>125 psig; 8 bar; 0.8 MPa</td> <td>250 psig; 17 bar; 1.7 MPa</td> </tr> </tbody> </table>	Without gauge		Y	L	30 psig; 2 bar; 0.2 MPa	60 psig; 4 bar; 0.4 MPa	N	H	125 psig; 8 bar; 0.8 MPa	250 psig; 17 bar; 1.7 MPa										
Without gauge																									
Y	L																								
30 psig; 2 bar; 0.2 MPa	60 psig; 4 bar; 0.4 MPa																								
N	H																								
125 psig; 8 bar; 0.8 MPa	250 psig; 17 bar; 1.7 MPa																								
				<b>Adjustment</b> N Non-rising knob T T-Handle																					

\* Regulator comes with gauge respective to the adjustment range selected.

Most popular.



For inventory, lead times, and kit lookup, visit [www.pdnplu.com](http://www.pdnplu.com)

**B**  
 Global Air Preparation  
 Introduction  
 Filters  
 Coalescers  
 Regulators  
 Filter / Regulators  
 Lubricators  
 Combinations  
 Accessories and Kits

## Material Specifications

Body	Aluminum
Adjustment knob	Acetal
Bonnet	Glass-filled nylon
Diaphragm assembly	Nitrile / zinc
Valve assembly	Brass / nitrile
Springs	Steel, stainless steel
Seals	Nitrile
Panel nut	Acetal

## Repair and Service Kits

Diaphragm repair kit - relieving	<b>P32KB00RB</b>
Diaphragm repair kit - non-relieving	<b>P32KB00RC</b>
Panel mount nut - aluminum	<b>P32KA00MM</b>
Panel mount nut - plastic	<b>P32KA00MP</b>
Angle bracket (attaches via panel nut)	<b>P32KB00MR</b>
T-bracket with body connector	<b>P32KA00MT</b>
T-bracket	<b>P32KA00MB</b>
Body connector	<b>P32KA00CB</b>

### WARNING

**Product rupture can cause serious injury.  
Do not connect regulator to bottled gas.  
Do not exceed Maximum primary pressure rating.**

### CAUTION:

**REGULATOR PRESSURE ADJUSTMENT** – The working range of knob adjustment is designed to permit outlet pressures within their full range. Pressure adjustment beyond this range is also possible because the knob is not a limiting device. This is a common characteristic of most industrial regulators, and limiting devices may be obtained only by special design. For best performance, regulated pressure should always be set by increasing the pressure up to the desired setting.

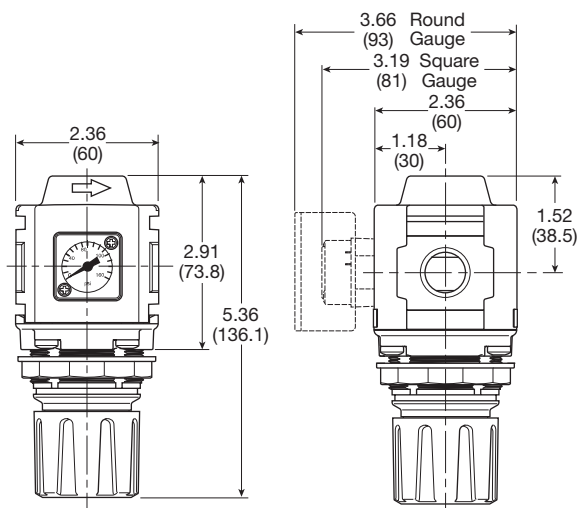

Inches (mm)

**NOTE:** 1.90 in. (48mm) hole required for panel nut mounting.

## Flow Charts

### P32RB 1/4" Regulator

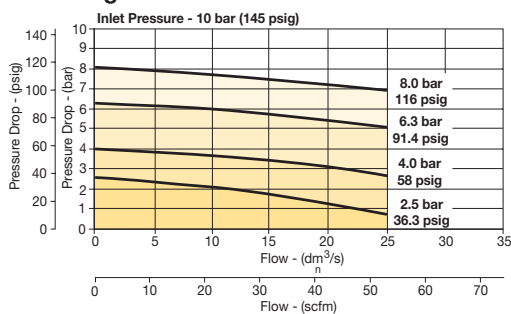

### P32RB 3/8" Regulator

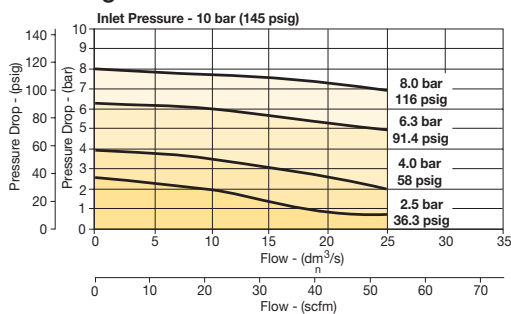

### P32RB 1/2" Regulator

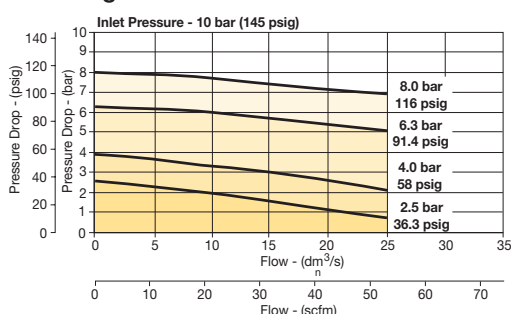

## Gauges

Square flush mount gauge	0-4 bar	<b>K4511SCR04B</b>
	0-11 bar	<b>K4511SCR11B</b>
	0-60 psig	<b>K4511SCR060</b>
	0-160 psig	<b>K4511SCR160</b>
Square with adapter kit	0-4 bar	<b>P6G-PR10040</b>
	0-11 bar	<b>P6G-PR10110</b>
	0-60 psig	<b>P6G-PR90060</b>
	0-160 psig	<b>P6G-PR90160</b>
50mm (2") round 1/4" center back mount	0-30 psig / 0-2 bar	<b>K4520N14030</b>
	0-60 psig / 0-4 bar	<b>K4520N14060</b>
	0-160 psig / 0-11 bar	<b>K4520N14160</b>
	0-300 psig / 0-20 bar	<b>K4520N14300</b>

For best performance, regulated pressure should always be set by increasing the pressure up to the desired setting.



For inventory, lead time, and kit lookup, visit [www.pdnplu.com](http://www.pdnplu.com)

## P32 Common - P1 Regulator – Compact

- Manifold style regulator with line pressure on both sides.
- Pressure output is at front or rear.
- Inlet ports 1/4", 3/8" or 1/2" (NPT, BSPP & BSPT)
- Working port 1/4"
- Robust construction
- Secondary pressure ranges
- Secondary aspiration plus balanced poppet provides quick response and accurate pressure regulation
- Relieving & non-relieving types
- Regulator will reverse flow as standard
- Non-rising knob

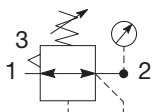
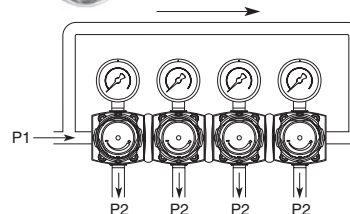

Self relieving regulator with gauge

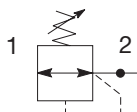

Non-relieving regulator

Port size	Description (relieving)	Gauge	Part number
1/4"	125 psig (8 bar)	None	<b>P32HB92BNNP</b>
3/8"	125 psig (8 bar)	None	<b>P32HB93BNNP</b>
1/2"	125 psig (8 bar)	None	<b>P32HB94BNNP</b>

### Operating information

Flow capacity*:	1/4, 3/8, 1/2	64 scfm (30 dm <sup>3</sup> /s, ANR)
Operating temperature:		-25°C to 65.5°C (-13°F to 150°F)
Supply pressure (max):		300 psig (20 bar)
Adjusting range pressure:		0 to 30 psig (0 to 2 bar) 0 to 60 psig (0 to 4 bar) 0 to 125 psig (0 to 8 bar) 0 to 232 psig (0 to 16 bar)
Gauge port (2 each):		1/4 NPT, BSPP, BSPT
Weight:		0.50 lb (1.10 kg)

\* Inlet pressure 145 psig (10 bar). Secondary pressure 91.3 psig (6.3 bar) and 14.5 psig (1 bar) pressure drop.

### Ordering Information:

**P32HB 9 2 B N N P**

<b>Basic series</b> Global modular compact regulator P32HB	<b>Thread type</b> BSPP 1 BSPT 2 NPT 9	<b>Port size †</b> 1/4 2 3/8 3 1/2 4	<b>Relief</b> Relieving B Non-relieving N	<b>Mounting</b> P Plastic panel mount nut
------------------------------------------------------------------	-------------------------------------------------	-----------------------------------------------	-------------------------------------------------	----------------------------------------------

† Working port 1/4".

With square gauge		Adjustment range	
psig	bar	With round gauge	
1 = 30*	V = 2*	Z	30 psig; 2 bar; 0.2 MPa
3 = 60	S = 4	M	60 psig; 4 bar; 0.4 MPa
5 = 125	T = 8	G	125 psig; 8 bar; 0.8 MPa
		J	250 psig; 17 bar; 1.7 MPa
		Without gauge	
		Y	30 psig; 2 bar; 0.2 MPa
		L	60 psig; 4 bar; 0.4 MPa
		N	125 psig; 8 bar; 0.8 MPa
		H	250 psig; 17 bar; 1.7 MPa

\* Regulator comes with gauge respective to the adjustment range selected.

<b>Adjustment</b>
N Non-rising knob
T T-Handle

Most popular.



For inventory, lead times, and kit lookup, visit [www.pdnplu.com](http://www.pdnplu.com)

**Material Specifications**

Body	Aluminum
Adjustment knob	Acetal
Bonnet	Glass-filled nylon
Diaphragm assembly	Nitrile / zinc
Valve assembly	Brass / nitrile
Springs	Steel, stainless steel
Seals	Nitrile
Panel nut	Acetal

**Repair and Service Kits**

Diaphragm repair kit - relieving	<b>P32KB00RB</b>
Diaphragm repair kit - non-relieving	<b>P32KB00RC</b>
Panel mount nut - aluminum	<b>P32KA00MM</b>
Panel mount nut - plastic	<b>P32KA00MP</b>
Angle bracket (attaches via panel nut)	<b>P32KB00MR</b>
T-bracket with body connector	<b>P32KA00MT</b>
T-bracket	<b>P32KA00MB</b>
Body connector	<b>P32KA00CB</b>

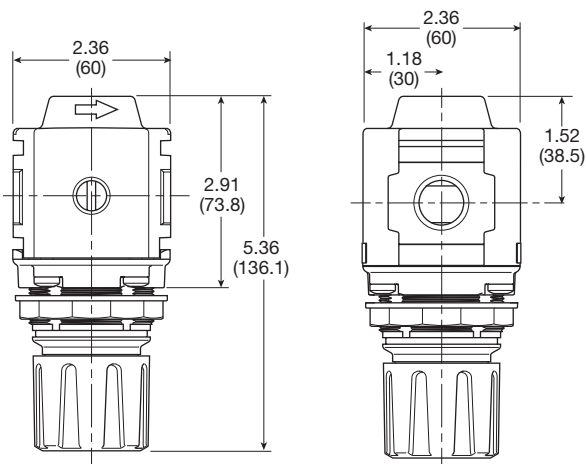

Inches (mm)

**NOTE:** 1.90 in. (48mm) hole required for panel nut mounting.

**Flow Charts**

**P32HB Common Port Regulator**

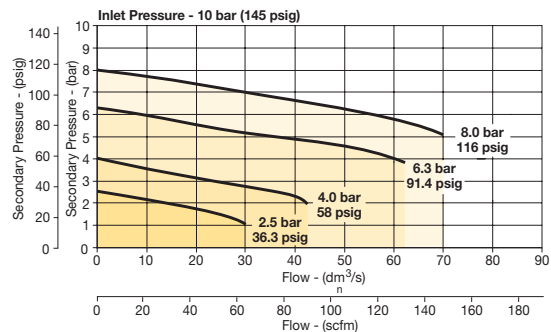

**⚠ WARNING**

**Product rupture can cause serious injury.  
 Do not connect regulator to bottled gas.  
 Do not exceed Maximum primary pressure rating.**

**CAUTION:**

**REGULATOR PRESSURE ADJUSTMENT** – The working range of knob adjustment is designed to permit outlet pressures within their full range. Pressure adjustment beyond this range is also possible because the knob is not a limiting device. This is a common characteristic of most industrial regulators, and limiting devices may be obtained only by special design. For best performance, regulated pressure should always be set by increasing the pressure up to the desired setting.

**Gauges**

Square flush mount gauge	0-4 bar	<b>K4511SCR04B</b>
	0-11 bar	<b>K4511SCR11B</b>
	0-60 psig	<b>K4511SCR060</b>
	0-160 psig	<b>K4511SCR160</b>
Square with adapter kit	0-4 bar	<b>P6G-PR10040</b>
	0-11 bar	<b>P6G-PR10110</b>
	0-60 psig	<b>P6G-PR90060</b>
	0-160 psig	<b>P6G-PR90160</b>
50mm (2") round 1/4" center back mount	0-30 psig / 0-2 bar	<b>K4520N14030</b>
	0-60 psig / 0-4 bar	<b>K4520N14060</b>
	0-160 psig / 0-11 bar	<b>K4520N14160</b>
	0-300 psig / 0-20 bar	<b>K4520N14300</b>

For best performance, regulated pressure should always be set by increasing the pressure up to the desired setting.



For inventory, lead time, and kit lookup, visit [www.pdnplu.com](http://www.pdnplu.com)

<b>B</b>	Global Air Preparation
Introduction	
Filters	
Coalescers	
Regulators	
Filter/Regulators	
Lubricators	
Combinations	
Accessories and Kits	

## P33 Regulators – Standard

- Integral 1/2" or 3/4" ports (NPT, BSPP & BSPT)
- Robust but lightweight aluminum construction
- Secondary pressure ranges
- Secondary aspiration plus balanced poppet provides quick response and accurate pressure regulation
- Relieving & non-relieving types
- Non-rising knob

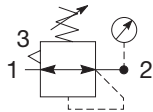

Self relieving regulator with gauge

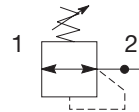

Non-relieving regulator

### Operating information

Flow capacity*:	1/2, 3/4	233 scfm (110 dm <sup>3</sup> /s, ANR)
Operating temperature:		-13°F to 150°F (-25°C to 65.5°C)
Supply pressure (max):		300 psig (20 bar)
Adjusting range pressure:		0 to 30 psig (0 to 2 bar) 0 to 60 psig (0 to 4 bar) 0 to 125 psig (0 to 8 bar) 0 to 250 psig (0 to 17 bar)
Gauge port (2 each):		1/4 NPT, BSPP, BSPT
Weight:		1.37 lb (0.62 kg)

\* Inlet pressure 145 psig (10 bar). Secondary pressure 91.3 psig (6.3 bar) and 14.5 psig (1 bar) pressure drop.

Port size	Description (relieving)	Gauge	Part number
1/2"	125 psig (8 bar)	None	<b>P33RA94BNNP</b>
1/2"	125 psig (8 bar)	Round	<b>P33RA94BNGP</b>
3/4"	125 psig (8 bar)	None	<b>P33RA96BNNP</b>
3/4"	125 psig (8 bar)	Round	<b>P33RA96BNGP</b>

### Ordering Information:

**P33RA 9 6 B N G P**

<b>Basic series</b> Global modular standard regulator P33RA	<b>Thread type</b> BSPP 1 BSPT 2 NPT 9	<b>Port size</b> 1/2 4 3/4 6	<b>Relief</b> Relieving B Non-relieving N Reverse flow-relieving R	<b>Adjustment</b> Non-rising knob N	<b>Mounting</b> P Plastic panel mount nut
-------------------------------------------------------------------	-------------------------------------------------	------------------------------------	-----------------------------------------------------------------------------	----------------------------------------	----------------------------------------------

Adjustment range	
With round gauge	
Z	30 psig; 2 bar; 0.2 MPa
M	60 psig; 4 bar; 0.4 MPa
G	125 psig; 8 bar; 0.8 MPa
J	250 psig; 17 bar; 1.7 MPa
Without gauge	
Y	30 psig; 2 bar; 0.2 MPa
L	60 psig; 4 bar; 0.4 MPa
N	125 psig; 8 bar; 0.8 MPa
H	250 psig; 17 bar; 1.7 MPa

Most popular.



For inventory, lead times, and kit lookup, visit [www.pdnplu.com](http://www.pdnplu.com)

**Material Specifications**

Body	Aluminum
Adjustment knob	Acetal
Body cap	ABS
Bonnet	Glass-filled nylon
Diaphragm assembly	Nitrile / zinc
Valve assembly	Brass / nitrile
Springs	Steel, stainless steel
Seals	Nitrile
Panel nut	Acetal

**Repair and Service Kits**

Diaphragm repair kit - relieving	<b>P33KA00RB</b>
Diaphragm repair kit - non-relieving	<b>P33KA00RC</b>
Panel mount nut - aluminum	<b>P33KA00MM</b>
Panel mount nut - plastic	<b>P33KA00MP</b>
Angle bracket (attaches via panel nut)	<b>P33KA00MR</b>
T-bracket with body connector	<b>P32KA00MT</b>
T-bracket	<b>P32KA00MB</b>
Body connector	<b>P32KA00CB</b>

**WARNING**

**Product rupture can cause serious injury.  
 Do not connect regulator to bottled gas.  
 Do not exceed Maximum primary pressure rating.**

**CAUTION:**

**REGULATOR PRESSURE ADJUSTMENT** – The working range of knob adjustment is designed to permit outlet pressures within their full range. Pressure adjustment beyond this range is also possible because the knob is not a limiting device. This is a common characteristic of most industrial regulators, and limiting devices may be obtained only by special design. For best performance, regulated pressure should always be set by increasing the pressure up to the desired setting.

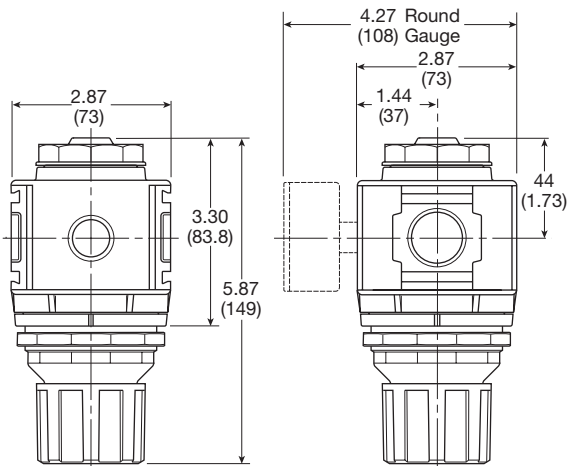

Inches (mm)

**NOTE:** 2.40 in. (61mm) hole required for panel nut mounting.

**Flow Charts**

**P33RA 1/2" Regulator**

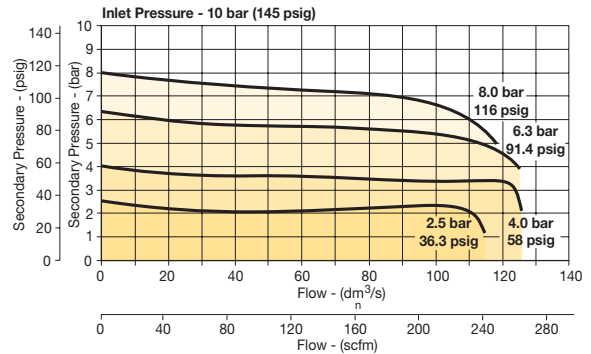

**P33RA 3/4" Regulator**

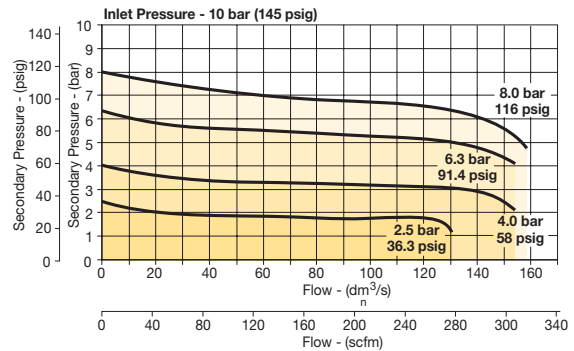

**Gauges**

<b>50mm (2") round 1/4" center back mount</b>	0-30 psig / 0-2 bar	<b>K4520N14030</b>
	0-60 psig / 0-4 bar	<b>K4520N14060</b>
	0-160 psig / 0-11 bar	<b>K4520N14160</b>
	0-300 psig / 0-20 bar	<b>K4520N14300</b>

For best performance, regulated pressure should always be set by increasing the pressure up to the desired setting.

# P31P & P32P Proportional Regulators

- Very fast response times
- Accurate output pressure
- Parameter settings
- Selectable I/O parameters
- Quick, full flow exhaust
- LED display indicates output pressure
- No air consumption in steady state
- Multiple mounting options
- Protection to IP65



P31P Series  
Bottom exhaust



P32P Series  
Bottom exhaust

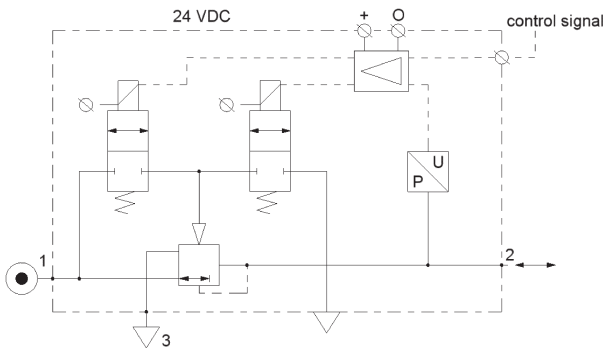

Port size	Description	Part number
1/4"	145 psig (0-10 bar), NC 0-10V	<b>P31PA92AD2VD1</b>
1/2"	145 psig (0-10 bar), NC 0-10V	<b>P32PA92AD2VD1</b>

## Operating information

Flow capacity*:	P31P	40 scfm (19 dm <sup>3</sup> /s, ANR)
	P32P	120 scfm (57 dm <sup>3</sup> /s, ANR)
Temperature range:	32°F to 122°F (0°C to 50°C)	
Supply pressure (max):	2 bar unit	36.3 psig (2.5 bar)
	10 bar unit	152 psig (10.5 bar)
Operating pressure (min):	P2 pressure + 7.3 psig (0.5 bar)	
Working medium:	Compressed air or inert gasses, filtered to 40µ	
Pressure range:	0 to 30 psig (0 to 2 bar)	0 to 145 psig (0 to 10 bar)
Weight:	P31P	0.64 lb (0.291 kg)
	P32P	1.42 lb (0.645 kg)

\* Inlet pressure 91.3 psig (6.3 bar), inlet pressure and 4.9 psig (0.34 bar) pressure drop.

## Ordering Information:

**P31PA 9 2 A D 2 V D 1**

<b>Body size</b>	<b>Thread type</b>	<b>Power supply</b>	<b>Control signal</b>	<b>Input connector</b>
Global modular mini (1/4") P31PA	BSPP 1	2 24 volts	V 0-10V <sup>†</sup>	1 M12 (4-pin)
Global modular compact (1/2") P32PA	BSPT 2		‡ Factory setting is 0-10 V control signal. 4-20 mA control signal available via parameter 4 on keypad.	
	NPT 9			
<b>Port size</b>	<b>Pressure range</b>		<b>Output signal</b>	
Global modular mini (1/4") 2	Z 0 - 29 psig (0 - 2 bar)		D Digital, PNP	
Global modular compact (1/2") 4	D 0 - 145 psig (0 - 10 bar)		P PNP or 0-10V	
			N NPN or 0-10V	
<b>Version</b>			M 4-20mA fixed	
Bottom ported exhaust (NC) A				D) Digital PNP output only, no analog output selectable
Bottom ported forced exhaust (NO) <sup>†</sup> E				P) Digital PNP and analogue 0-10V outputs selectable, by means of parameter 6. (Factory default 0-10V)

† When the supply voltage is lost the unit will automatically exhaust the regulated pressure to 0 bar (atmospheric pressure)

D) Digital PNP output only, no analog output selectable  
 P) Digital PNP and analogue 0-10V outputs selectable, by means of parameter 6. (Factory default 0-10V)  
 N) Digital NPN and analog 0-10 V outputs selectable by means of parameter 6. Factory default 0-10V  
 M) Analog 4-20mA output only.  
 Note: On all analog outputs the F.S. value can be adjusted by means of parameter 8.

Most popular.



For inventory, lead times, and kit lookup, visit [www.pdnplu.com](http://www.pdnplu.com)



**Proportional Regulators**

**Technical Information**

**Accuracy**

+/- 1.0% of F.S.\*

\* Full scale (F.S.) - For 2 bar (29 psig) versions this will be 2 bar (29 psig), for the 10 bar (145 psig) version full scale will be 10 bar (145 psig).

**Air consumption**

No consumption in stable regulated situation.

**Display**

The regulator is provided with a digital display, indicating the output pressure, either in bar or psig.

The factory setting is as indicated on the label, can be changed through to software at all times (parameter 14)

**Supply voltage**

24 VDC +/- 10%

**Power consumption**

Max. 1.1W with unloaded signal outputs

**Control signals**

The electronic pressure regulator can be externally controlled through an analogue control signal of either 0-10V or 4-20mA. (parameter 4).

**Output signals**

As soon as the output pressure is within the signal band a signal is given of 24VDC, PNP Ri = 1 kOhm  
Outside the signal band this connection is 0V.

**Connections**

(In case of output signal (Option D)  
Central M12 connector 4-pole  
The electrical connections are as follows:

Pin No.	Function	Color
1	24 V Supply	Brown
2	0 to 10 V Control Signal Ri = 100k Ω	White
	4 to 20mA Control Signal Ri = 500 Ω	
3	0 V (GND) Supply & Set Point Ground	Blue
4	24 V Alarm Output Signal	Black

**Flow Charts**

**P31P Regulator 1/4" Ports**

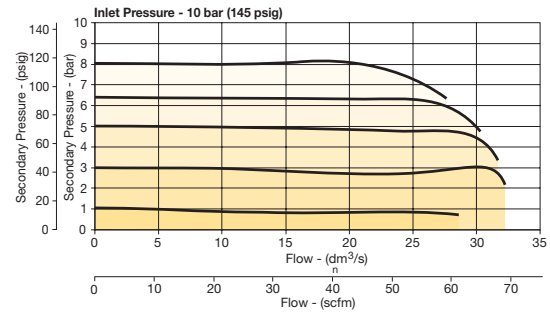

**P32P Regulator 1/2" Ports**

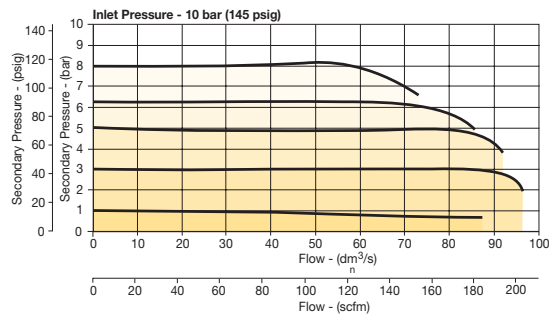

**Degree of protection:** IP65

**EU conformity**

CE: standard  
EMC: according to directive 89/336/EEC  
This pressure regulator is in accordance with:

- EN 61000-6-1:2001**      **EN 61000-6-2:2001**
- EN 61000-6-3:2001**      **EN 61000-6-4:2001**

**Mounting position**

Preferably vertical, with the cable gland on top.

**Materials: P31P & P32P**

Magnet core	Steel
Solenoid valve poppet	FPM
Solenoid valve housing	Techno polymer
Regulator body (P31P & P32P versions)	Aluminum
Regulator top housing	Nylon
Valve head	Brass & NBR
Remaining seals	NBR

**B**

Global Air Preparation

Introduction

Filters

Coalescers

Regulators

Filter/Regulators

Lubricators

Combinations

Accessories and Kits



For inventory, lead time, and kit lookup, visit [www.pdnplu.com](http://www.pdnplu.com)

**How to change parameters – How to Videos available at [www.parker.com/pneu/propreg](http://www.parker.com/pneu/propreg)**

Pressing the Accept key “acc” for more than 3 seconds, will activate parameter change mode. The user can then select the parameters by pressing up or down key (display will show Pxx). When parameter number is correct, pressing accept again will enter parameter number (display will show parameter value).

Pressing the up or down key will change the parameter itself (display will flash indicating parameter editing mode). Pressing the accept key will accept the new parameter value (all digits will flash whilst being accepted).

After releasing all keys, the next parameter number will be presented on the display (you may step to the next parameter). When no key is pressed, after 3 seconds the display will show the actual output pressure.

When the unit is initially powered up allow approximately 10 seconds for the unit to “boot-up” before changing parameter settings.

Only parameter numbers 0, 4, 6, 8, 9, 14, 18, 19, 20, 12, 13 and 21 are accessible to edit. All other parameters are fixed.

**Manual mode:**















When keys DOWN and UP are pressed during startup, (connecting to the 24V power supply) manual mode is activated. This means that the user is able to in/decrease the output pressure of the regulator, by pressing the UP or DOWN key. During this action the display will blink, indicating that the manual mode is activated. After powering up again, the unit will revert back to normal mode.

**Back to Factory Setting**

After start up. (Power is on)

Entering this value in parameter 0 will store the calibrated factory data into the working parameters. (Default calibration data is used)















**Parameter Number 0 – Reset Back to Factory Settings**

Step	1	2	3	4	5	
<b>Press</b> 	 3-6 seconds	 or 		 or 		
<b>Until Display Reads</b>			 Flashing Decimal	 Flashing Decimal	 Flashing	
<b>Description</b>	Accesses changeable parameters.	Accesses parameter no. 0.	Displays current parameter value.	Edits parameter. 3 = standard factory settings. If other than 3, use Up or Down Arrow and accept 3	Accepts and saves new parameter setting.	Sequences to next parameter.

**Set Control Signal**

The unit is factory set for 0-10 V control signal. If 4-20 mA control signal is required, change parameter 4.

**Parameter Number 4 – Set Control Signal in Volts or Milliamps**

Step	1	2	3	4	5	
<b>Press</b> 	 3-6 seconds	 or 		 or 		
<b>Until Display Reads</b>			 Flashing Decimal	 Flashing Decimal	 Flashing	
<b>Description</b>	Accesses changeable parameters.	Accesses parameter no. 4.	Displays current parameter value. 1 = V 0 = mA	Edits parameter.	Accepts and saves new parameter setting.	Sequences to next parameter.

How to Videos at [www.parker.com/pneu/propreg](http://www.parker.com/pneu/propreg)

**B**  
 Global Air Preparation  
 Introduction  
 Filters  
 Coalescers  
 Regulators  
 Filter / Regulators  
 Lubricators  
 Combinations  
 Accessories and Kits



For inventory, lead times, and kit lookup, visit [www.pdnplu.com](http://www.pdnplu.com)

**Set Output Signal**

Parameter 6 is used to set the type of output signal to your PLC.  
 This parameter is used as follows:

Output Signal option “0” = Digital Output – PNP

- Factory set at “0” Non Adjustable

Output Signal option “P” = Digital PNP or Analog 1-10V

- Factory set at “1” for Analog Signal
- Convert to Digital PNP by changing parameter to “0” setting











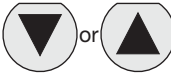

Output Signal option “N” = Digital NPN or Analog 1-10V

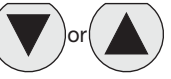
- Factory set at “1” Analog Signal
- Convert to Digital NPN by changing parameter to “0”

Output Signal option “M” = Analog 4-20 mA

- Factory set at “2” Non Adjustable

**Parameter Number 6 – Set Output Signal**

Step	1	2	3	4	5	
<b>Press</b> 	 3-6 seconds					
<b>Until Display Reads</b>			 Flashing Decimal	 Flashing Decimal (Value 0, 1 or 2)	 Flashing	
<b>Description</b>	Accesses changeable parameters.	Accesses parameter no. 6.	Displays current parameter value. 1 = m factory default for P3H with analog options	Edits parameter. 0 = digital (NPN or PNP) 1 = analog 0..10V 2 = analog 4..20 mA	Accepts and saves new parameter setting.	Sequences to next parameter.











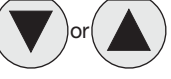

**Adjust Span Analog Output Signal**

Set value is a % of Full Analog range. As an example for a 0-10V output signal, the original factory setting of 100% will give you an adjustment of 0-10V. If you reset Parameter 8 to 50%, the new output range would be 0-5V or 50% of the full range.

In the event that the output signal is to low, in a certain application, you can adjust it by increasing Parameter 8 to a maximum value of 130% of scale.

Note that all values are nominal and that an actual measurement may be required to ensure signal strength.

**Parameter Number 8 – Adjust Span Analog Output Signal**

Step	1	2	3	4	5	
<b>Press</b> 	 3-6 seconds					
<b>Until Display Reads</b>			 Flashing Decimal (For 2 bar versions value = 92)	 Flashing Decimal (Value between 0 and 130)	 Flashing	
<b>Description</b>	Accesses changeable parameters.	Accesses parameter no. 8.	Displays current parameter value.	Edits parameter.	Accepts and saves new parameter setting and implements the new analog signal span.	Sequences to next parameter.

How to Videos at [www.parker.com/pneu/propreg](http://www.parker.com/pneu/propreg)



For inventory, lead time, and kit lookup, visit [www.pdnplu.com](http://www.pdnplu.com)

**B**

Global Air Preparation

Introduction

Filters

Coalescers

Regulators

Filter/Regulators

Lubricators











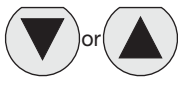

Combinations

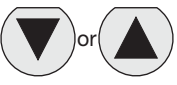
Accessories and Kits

**Adjust Digital Display**

If necessary, adjustments can be made to the digital display when using an external pressure sensor.











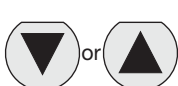

**Parameter Number 9 – Adjust Digital Display Value (Pressure Calibration)**

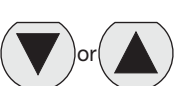
Step	1	2	3	4	5	
<b>Press</b> 	 3-6 seconds					
<b>Until Display Reads</b>			 Flashing Decimal	 Flashing Decimal	 Flashing	
<b>Description</b>	Accesses changeable parameters.	Accesses parameter no. 9.	Displays current digital display	Use up or down arrows and accept to adjust the display value if using an external pressure sensor.	Accepts and saves new parameter setting.	Sequences to next parameter.

**Set Pressure Scale**

Units with NPT port threads are supplied with a factory set psig pressure scale. Use parameter 14 to change scale to bar.

**Parameter Number 14 – Set Pressure Scale in psig or bar**

Step	1	2	3	4	5	
<b>Press</b> 	 3-6 seconds					
<b>Until Display Reads</b>			 Flashing Decimal	 Flashing Decimal	 Flashing	
<b>Description</b>	Accesses changeable parameters.	Accesses parameter no. 14.	Displays current parameter value. 1 = psig 0 = bar 2 = MPa	Edits parameter.	Accepts and saves new parameter setting.	Sequences to next parameter.

How to Videos at [www.parker.com/pneu/propreg](http://www.parker.com/pneu/propreg)













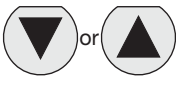

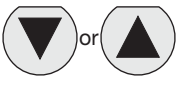
For inventory, lead times, and kit lookup, visit [www.pdnplu.com](http://www.pdnplu.com)

**B**  
Global Air Preparation  
Introduction  
Filters  
Coalescers  
Regulators  
Filter / Regulators  
Lubricators  
Combinations  
Accessories and Kits

**Preset Minimum Pressure**

If there is a need for a pre-set Minimum pressure, use parameter 18. (Note: preset pressure is affected by % P19.)

Parameter Number 18 – Set Minimum Preset Pressure						
Step	1	2	3	4	5	
<b>Press</b> 	 3-6 seconds					
<b>Until Display Reads</b>			 Flashing Decimal	 Flashing Decimal (value between 0 and 200)	 Flashing	
<b>Description</b>	Accesses changeable parameters.	Accesses parameter no. 18.	Displays current parameter value. Incremental value is: <u>2 bar unit:</u> x 2 mbar x % P19  <u>10 bar unit:</u> x 10 mbar x % P19	Edits parameter.	Accepts and saves new parameter setting.	Sequences to next parameter.









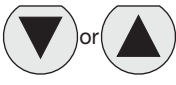

**Set Pressure Correction**

Pressure correction allows the user to set a Maximum pressure as a percentage of secondary pressure F.S.

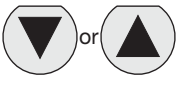
**Example:** If F.S. is 10 bar, set parameter 19 to 50 for Maximum preset pressure of 5 bar.

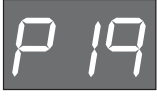
Pressure correction also affects the Minimum preset pressure in parameter 18.

**Example:** If F.S. is 10 bar and parameter 18 is set to a value of 100 (1 bar), and parameter 19 is set to 50%, then the actual Minimum preset pressure seen is 0.5 bar.

Parameter Number 19 – Set Maximum Preset Pressure						
Step	1	2	3	4	5	
<b>Press</b> 	 3-6 seconds					
<b>Until Display Reads</b>			 Flashing Decimal	 Flashing Decimal (value between 0 and 100)	 Flashing	
<b>Description</b>	Accesses changeable parameters.	Accesses parameter no. 19.	Displays current parameter value. Incremental value is: % of F.S.	Edits parameter.	Accepts and saves new parameter setting.	Sequences to next parameter.

How to Videos at [www.parker.com/pneu/propreg](http://www.parker.com/pneu/propreg)













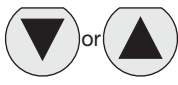

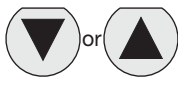
For inventory, lead time, and kit lookup, visit [www.pdnplu.com](http://www.pdnplu.com)

**Behavior Control**

The regulation speed of the pressure regulator can be modified by means of one parameter. (P 20)  
The value in this parameter has a range from 0-5. A higher value indicates slower regulation speed, but will be more stable.

**Parameter Number 20 – Set Behavior Control**











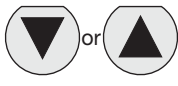

Step	1	2	3	4	5	
<b>Press</b> 	 3-6 seconds					
<b>Until Display Reads</b>			 Flashing Decimal	 Flashing Decimal (value between 0 and 5)	 Flashing	
<b>Description</b>	Accesses changeable parameters.	Accesses parameter no. 20.	Displays current parameter value.	Edits parameter 0 = custom set* 1 = fastest (narrow proportional band) 2 = fast 3 = normal 4 = slow 5 = slowest (proportional band is broad)	Accepts and saves new parameter setting.	Sequences to next parameter.

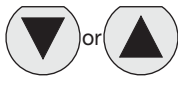
\* When the value 0 is entered, you are able to create your own custom settings true parameters 12, 13 and 21.

**Fine Settings  
Set Proportional Band**

Proportional band is used for setting the reaction sensitivity of the regulator. The displayed value is X 10 mbar and has a range between 50 (0.5 bar) and 250 (2.5 bar).

**Parameter Number 12 – Set Proportional Band (P20 Must be Set to 0)**

Step	1	2	3	4	5	
<b>Press</b> 	 3-6 seconds					
<b>Until Display Reads</b>			 Flashing Decimal	 Flashing Decimal (value between 50 and 250)	 Flashing	
<b>Description</b>	Accesses changeable parameters.	Accesses parameter no. 12.	Displays current parameter value. Incremental value is: x 10 mbar	Edits parameter.	Accepts and saves new parameter setting.	Sequences to next parameter.

How to Videos at [www.parker.com/pneu/propreg](http://www.parker.com/pneu/propreg)

**B**  
Global Air Preparation  
Introduction  
Filters  
Coalescers  
Regulators  
Filter / Regulators  
Lubricators  
Combinations  
Accessories and Kits













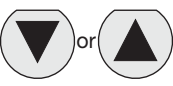

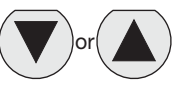
For inventory, lead times, and kit lookup, visit [www.pdnplu.com](http://www.pdnplu.com)

**Set Deadband**











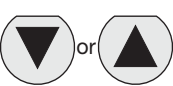

Deadband is the Minimum limit of accuracy at which the regulator is set for normal operation. The displayed value is X 10 mbar and has a range between 4 (40 mbar) and 40 (400 mbar).

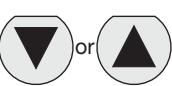
**Parameter Number 13 – Set Deadband (P20 Must be Set to 0)**







Step	1	2	3	4	5	
<b>Press</b> 	 3-6 seconds					
<b>Until Display Reads</b>			 Flashing Decimal	 Flashing Decimal (value between 4 and 40)	 Flashing	
<b>Description</b>	Accesses changeable parameters.	Accesses parameter no. 13.	Displays current parameter value. Incremental value is x 10 mbar	Edits parameter.	Accepts and saves new parameter setting.	Sequences to next parameter.

**Proportional Effect**

**Parameter Number 21 – Set Proportional Effect (P20 Must be Set to 0)**

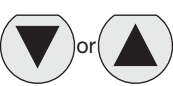
Step	1	2	3	4	5	
<b>Press</b> 	 3-6 seconds					
<b>Until Display Reads</b>			 Flashing Decimal	 Flashing Decimal (value between 5 and 100)	 Flashing	
<b>Description</b>	Accesses changeable parameters.	Accesses parameter no. 21.	Displays current parameter value.	Edits parameter. 5 = fastest regulation 100 = slowest regulation.	Accepts and saves new parameter setting.	Sequences to next parameter.

**Parameter Number 39 – Displays Current Software Version**

Step	1	2	3	
<b>Press</b> 	 3-6 seconds			
<b>Until Display Reads</b>			 Flashing Decimal	
<b>Description</b>	Accesses changeable parameters.	Accesses parameter no. 39.	Displays current parameter value. XXX = current software version	

How to Videos at [www.parker.com/pneu/propreg](http://www.parker.com/pneu/propreg)



For inventory, lead time, and kit lookup, visit [www.pdnplu.com](http://www.pdnplu.com)

**P31P**

Dimensions inches (mm)

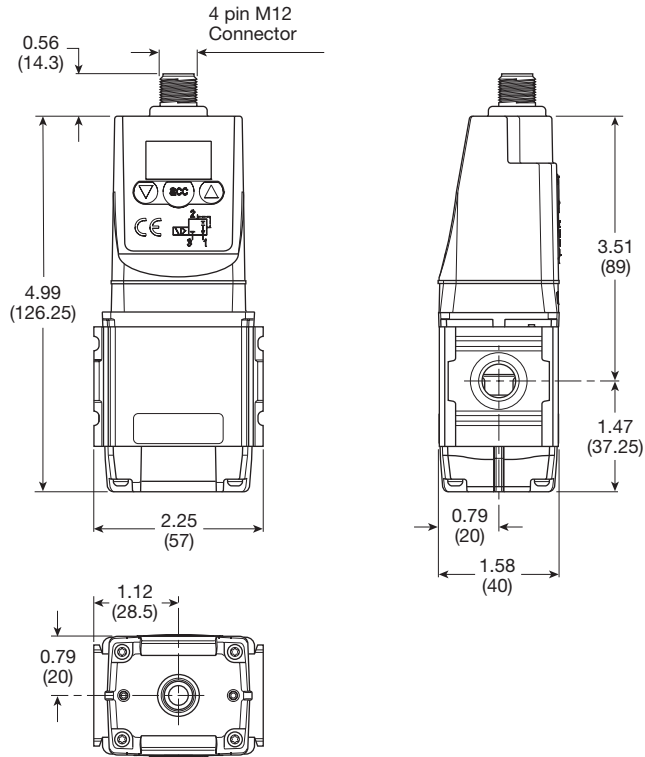

**L-Bracket  
P3HKA00ML**

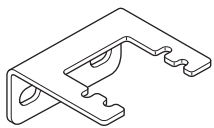
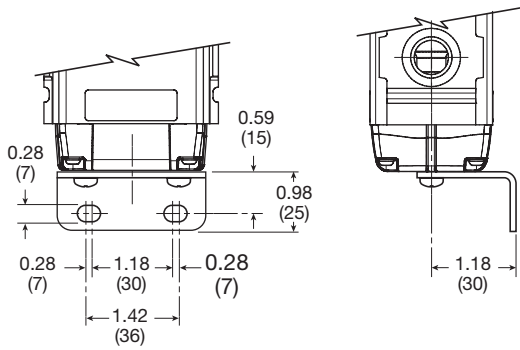

**Foot Bracket  
P3HKA00MC**

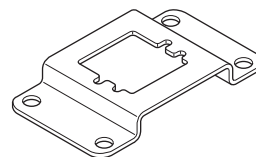
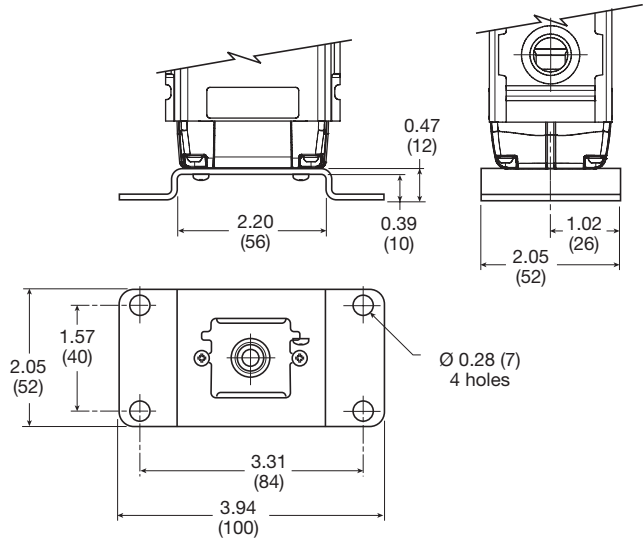

**Cables**

Description	Part number
2 mtr. cable with moulded straight M12x1 connector	<b>CB-M12-4P-2M</b>

Most popular.

<b>B</b>
Global Air Preparation
Introduction
Filters
Coalescers
Regulators
Filter / Regulators
Lubricators
Combinations
Accessories and Kits



For inventory, lead times, and kit lookup, visit [www.pdnplu.com](http://www.pdnplu.com)



**P32P**

Dimensions inches (mm)

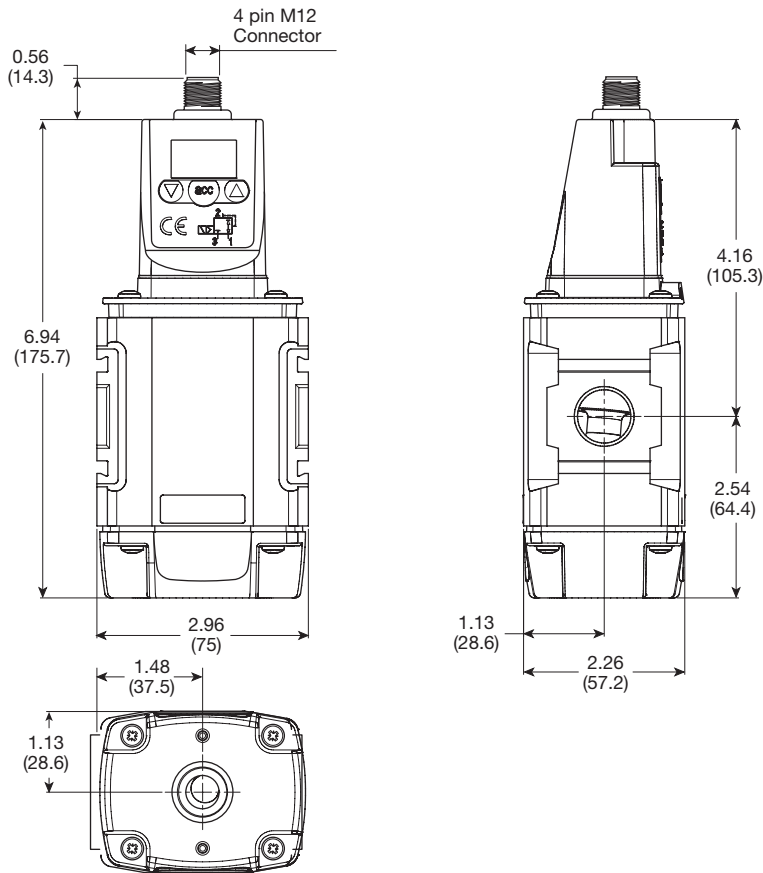

**L-Bracket**  
**P3KKA00ML**

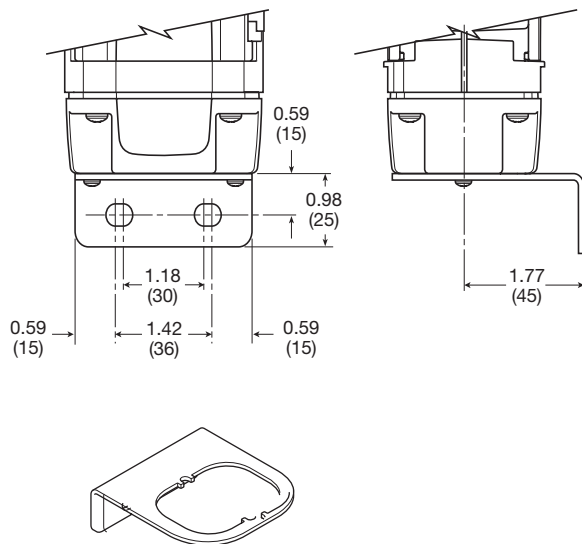

**Foot Bracket**  
**P3KKA00MC**

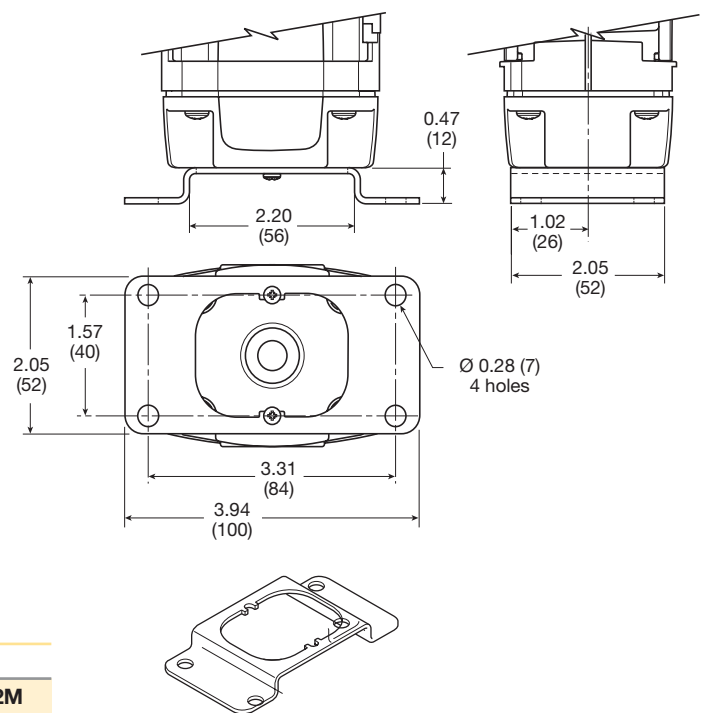

**Cables**

Description	Part number
2 mtr. cable with moulded straight M12x1 connector	<b>CB-M12-4P-2M</b>

Most popular.



For inventory, lead time, and kit lookup, visit [www.pdnplu.com](http://www.pdnplu.com)

## P31 Filter / Regulators – Mini

- Integral 1/4" ports (NPT, BSPP & BSPT)
- High efficiency 5 micron element as standard
- Excellent water removal efficiency
- Robust but lightweight aluminum construction
- Positive bayonet latch to ensure correct & safe fitting
- Secondary pressure ranges
- Secondary aspiration plus balanced poppet provides quick response and accurate pressure regulation

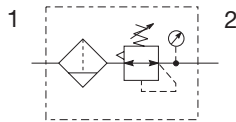

Port size	Description (relieving)	Bowl / drain type †	Part number
1/4"	125 psig (8 bar)	Poly / manual	<b>P31EB92EGMBN5P</b>
1/4"	125 psig (8 bar)	Poly / pulse	<b>P31EB92EGBBN5P</b>
1/4"	125 psig (8 bar)	Metal / manual	<b>P31EB92EMMBN5P</b>
1/4"	125 psig (8 bar)	Metal / pulse	<b>P31EB92EMBBN5P</b>

† For polycarbonate bowl, see caution in Engineering Section A.

### Operating information

Flow capacity*:	1/4	73 scfm (35 dm <sup>3</sup> /s, ANR)
Operating temperature†:	Plastic bowl	14°F to 125°F (-10°C to 52°C)
	Metal bowl	14°F to 150°F (-10°C to 65.5°C)
Supply pressure (max):	Plastic bowl	150 psig (10 bar)
	Metal bowl	250 psig (17 bar)
Standard filtration		5 micron
Useful retention†:		0.4 US oz. (12 cm <sup>3</sup> )
Adjusting range pressure:		0 to 30 psig (0 to 2 bar)
		0 to 60 psig (0 to 4 bar)
		0 to 125 psig (0 to 8 bar)
		0 to 250 psig (0 to 17 bar)
Gauge port (2 each)**:		1/8 NPT, BSPP, BSPT
Weight:		0.42 lb (0.19 kg)

\* Inlet pressure 145 psig (10 bar). Secondary pressure 91.3 psig (6.3 bar) and 14.5 psig (1 bar) pressure drop.

\*\* Non-gauge option only.

† Units with square gauges: 5°F to 150°F (-15°C to 65.5°C)

‡ Useful retention refers to volume below the quiet zone baffle.

Air quality: Within ISO 8573-1: 1991 Class 3 (Particulates)  
 Within ISO 8573-1: 2001 Class 6 (Particulates)

### Ordering Information:

**P31EB 9 2 E G M B N 5 P**

<b>Basic series</b> Global modular mini filter / regulator P31EB	<b>Thread type</b> BSPP 1 BSPT 2 NPT 9	<b>Element</b> 5µ Element E	<b>Port size</b> 1/4 2	<b>Bowl type</b> Poly bowl with bowl guard G Metal bowl without sight gauge M	<b>Drain type</b> Pulse drain B Manual drain M Flex drain X	<b>Adjustment</b> N Non-rising knob	<b>Relief</b> B Relieving N Non-relieving	<b>Mounting</b> p Plastic panel mount nut																																												
						<table border="1"> <thead> <tr> <th colspan="2">With square gauge</th> <th colspan="2">Adjustment range</th> </tr> <tr> <th>psig</th> <th>bar</th> <th colspan="2">With round gauge</th> </tr> </thead> <tbody> <tr> <td>1 = 30*</td> <td>V = 2*</td> <td>Z</td> <td>30 psig; 2 bar; 0.2 MPa</td> </tr> <tr> <td>3 = 60</td> <td>S = 4</td> <td>M</td> <td>60 psig; 4 bar; 0.4 MPa</td> </tr> <tr> <td>5 = 125</td> <td>T = 8</td> <td>G</td> <td>125 psig; 8 bar; 0.8 MPa</td> </tr> <tr> <td colspan="2"></td> <td>J<sup>§</sup></td> <td>232 psig; 16 bar; 1.6 MPa</td> </tr> <tr> <td colspan="4" style="text-align: center;"><b>Without gauge</b></td> </tr> <tr> <td colspan="2"></td> <td>Y</td> <td>30 psig; 2 bar; 0.2 MPa</td> </tr> <tr> <td colspan="2"></td> <td>L</td> <td>60 psig; 4 bar; 0.4 MPa</td> </tr> <tr> <td colspan="2"></td> <td>N</td> <td>125 psig; 8 bar; 0.8 MPa</td> </tr> <tr> <td colspan="2"></td> <td>H<sup>§</sup></td> <td>232 psig; 16 bar; 1.6 MPa</td> </tr> </tbody> </table>			With square gauge		Adjustment range		psig	bar	With round gauge		1 = 30*	V = 2*	Z	30 psig; 2 bar; 0.2 MPa	3 = 60	S = 4	M	60 psig; 4 bar; 0.4 MPa	5 = 125	T = 8	G	125 psig; 8 bar; 0.8 MPa			J <sup>§</sup>	232 psig; 16 bar; 1.6 MPa	<b>Without gauge</b>						Y	30 psig; 2 bar; 0.2 MPa			L	60 psig; 4 bar; 0.4 MPa			N	125 psig; 8 bar; 0.8 MPa			H <sup>§</sup>	232 psig; 16 bar; 1.6 MPa
With square gauge		Adjustment range																																																		
psig	bar	With round gauge																																																		
1 = 30*	V = 2*	Z	30 psig; 2 bar; 0.2 MPa																																																	
3 = 60	S = 4	M	60 psig; 4 bar; 0.4 MPa																																																	
5 = 125	T = 8	G	125 psig; 8 bar; 0.8 MPa																																																	
		J <sup>§</sup>	232 psig; 16 bar; 1.6 MPa																																																	
<b>Without gauge</b>																																																				
		Y	30 psig; 2 bar; 0.2 MPa																																																	
		L	60 psig; 4 bar; 0.4 MPa																																																	
		N	125 psig; 8 bar; 0.8 MPa																																																	
		H <sup>§</sup>	232 psig; 16 bar; 1.6 MPa																																																	

\* Regulator comes with gauge respective to the adjustment range selected.  
 § Not available with poly bowl with bowl guard.

Most popular.



For inventory, lead times, and kit lookup, visit [www.pdnplu.com](http://www.pdnplu.com)

B42

**Parker Hannifin Corporation**  
 Pneumatic Division  
 Richland, Michigan  
[www.parker.com/pneumatics](http://www.parker.com/pneumatics)

# Mini Filter / Regulators

## Material Specifications

Body	Aluminum
Adjustment knob	Acetal
Body cap	ABS
Bonnet	PBT
Plastic bowl	Polycarbonate
Metal bowl	Aluminum
Bowl guard	Nylon
Filter element	Polyethylene
Seals	Nitrile
Springs	Steel
Valve assembly	Brass / Nitrile
Diaphragm assembly	Brass / Nitrile
Panel nut	Acetal

### ⚠ WARNING

**Product rupture can cause serious injury.  
Do not connect regulator to bottled gas.  
Do not exceed Maximum primary pressure rating.**

### CAUTION:

**REGULATOR PRESSURE ADJUSTMENT** – The working range of knob adjustment is designed to permit outlet pressures within their full range. Pressure adjustment beyond this range is also possible because the knob is not a limiting device. This is a common characteristic of most industrial regulators, and limiting devices may be obtained only by special design. For best performance, regulated pressure should always be set by increasing the pressure up to the desired setting.

# Air Preparation Products Global Air Preparation

## Flow Charts

### P31EB 1/4" Filter / Regulator

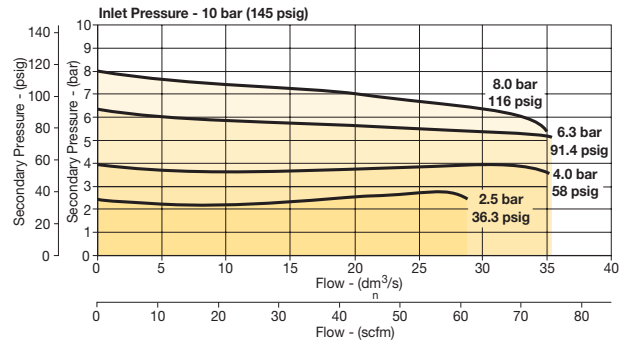

## Repair and Service Kits

Plastic bowl / bowl guard manual drain	<b>P31KB00BGM</b>
Plastic bowl / bowl guard pulse drain	<b>P31KB00BGB</b>
Metal bowl / w/o sight gauge pulse drain	<b>P31KB00BMB</b>
5µ particle filter element	<b>P31KA00ESE</b>
Diaphragm repair kit - relieving	<b>P31KB00RB</b>
Diaphragm repair kit - non-relieving	<b>P31KB00RC</b>
Panel mount nut - aluminum	<b>P31KA00MM</b>
Panel mount nut - plastic	<b>P31KA00MP</b>
Angle bracket (attaches via panel nut)	<b>P31KB00MR</b>
C-bracket (fits to body)	<b>P31KA00MW</b>
T-bracket with body connector	<b>P31KA00MT</b>
Body connector	<b>P31KA00CB</b>

## Gauges

Square flush mount gauge	0-4 bar	<b>K4511SCR04B</b>
	0-11 bar	<b>K4511SCR11B</b>
	0-60 psig	<b>K4511SCR060</b>
	0-160 psig	<b>K4511SCR160</b>

For best performance, regulated pressure should always be set by increasing the pressure up to the desired setting.

**B**

Global Air Preparation

Introduction

Filters

Coalescers

Regulators

Filter / Regulators

Lubricators

Combinations

Accessories and Kits

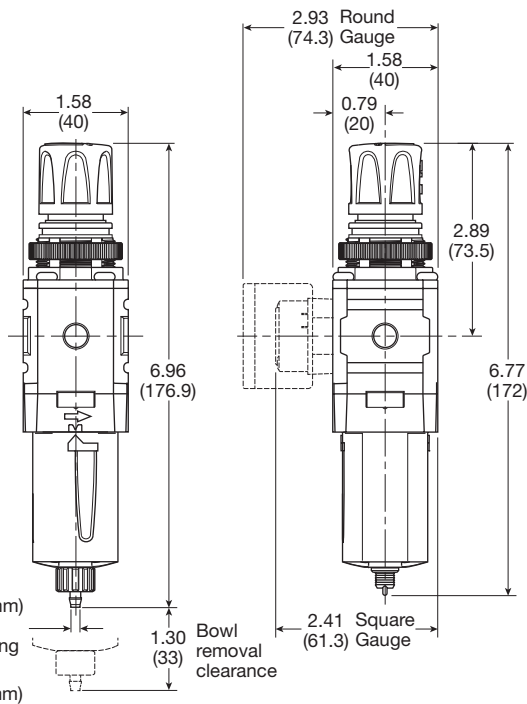

Manual Drain

Pulse Drain



For inventory, lead time, and kit lookup, visit [www.pdnplu.com](http://www.pdnplu.com)

**P32 Filter / Regulators – Compact**

- Integral 1/4", 3/8" or 1/2" ports (NPT, BSPP & BSPT)
- High efficiency 5 micron element as standard
- Excellent water removal efficiency
- Robust but lightweight aluminum construction
- Positive bayonet latch to ensure correct & safe fitting
- Secondary pressure ranges
- Secondary aspiration plus balanced poppet provides quick response and accurate pressure regulation

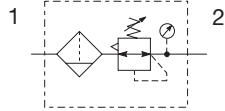

Port size	Description (relieving)	Bowl / drain type †	Part number
1/4"	125 psig (8 bar)	Poly / manual	<b>P32EB92EGMBNGP</b>
1/4"	125 psig (8 bar)	Poly / auto	<b>P32EB92EGABNGP</b>
1/4"	125 psig (8 bar)	Metal / manual	<b>P32EB92ESMBNGP</b>
1/4"	125 psig (8 bar)	Metal / auto	<b>P32EB92ESABNGP</b>
3/8"	125 psig (8 bar)	Poly / manual	<b>P32EB93EGMBNGP</b>
3/8"	125 psig (8 bar)	Poly / auto	<b>P32EB93EGABNGP</b>
3/8"	125 psig (8 bar)	Metal / manual	<b>P32EB93ESMBNGP</b>
3/8"	125 psig (8 bar)	Metal / auto	<b>P32EB93ESABNGP</b>
1/2"	125 psig (8 bar)	Poly / manual	<b>P32EB94EGMBNGP</b>
1/2"	125 psig (8 bar)	Poly / auto	<b>P32EB94EGABNGP</b>
1/2"	125 psig (8 bar)	Metal / manual	<b>P32EB94ESMBNGP</b>
1/2"	125 psig (8 bar)	Metal / auto	<b>P32EB94ESABNGP</b>

† For polycarbonate bowl, see caution in Engineering Section A.

**Operating information**

Flow capacity*:	1/4	148 scfm (70 dm <sup>3</sup> /s, ANR)
	3/8	158 scfm (75 dm <sup>3</sup> /s, ANR)
	1/2	164 scfm (77 dm <sup>3</sup> /s, ANR)
Operating temperature:		
Plastic bowl		-13°F to 125°F (-25°C to 52°C)
Metal bowl		-13°F to 150°F (-25°C to 65.5°C)
Supply pressure (max):		
Plastic bowl		150 psig (10 bar)
Metal bowl		250 psig (17 bar)
Standard filtration:		5 micron
Useful retention†:		1.7 US oz. (51 cm <sup>3</sup> )
Adjusting range pressure:		0 to 30 psig (0 to 2 bar) 0 to 60 psig (0 to 4 bar) 0 to 125 psig (0 to 8 bar) 0 to 250 psig (0 to 17 bar)
Gauge port (2 each):		1/4 NPT, BSPP, BSPT
Weight:		1.17 lb (0.53 kg)

\* Inlet pressure 145 psig (10 bar). Secondary pressure 91.3 psig (6.3 bar) and 14.5 psig (1 bar) pressure drop.

† Useful retention refers to volume below the quiet zone baffle.

Air quality: Within ISO 8573-1: 1991 Class 3 (Particulates)  
Within ISO 8573-1: 2001 Class 6 (Particulates)

**Ordering Information:**

<b>P32EB</b>	<b>9</b>	<b>2</b>	<b>E</b>	<b>G</b>	<b>M</b>	<b>B</b>	<b>N</b>	<b>5</b>	<b>P</b>																																								
<b>Basic series</b> Global modular compact filter / regulator P32EB	<b>Thread type</b> BSPP 1 BSPT 2 NPT 9	<b>Element</b> 5µ Element E	<b>Port size</b> 1/4 2 3/8 3 1/2 4	<b>Bowl type</b> Poly bowl with bowl guard G Metal bowl without sight gauge M Metal bowl with sight gauge S	<b>Drain type</b> Manual drain M Auto drain A Flex drain X	<b>Adjustment</b> N Non-rising knob T T-Handle	<b>Relief</b> B Relieving N Non-relieving	<b>Mounting</b> P Plastic panel mount nut	<b>Adjustment range</b>																																								
								<table border="1"> <thead> <tr> <th colspan="2">With square gauge</th> <th colspan="2">With round gauge</th> </tr> <tr> <th>psig</th> <th>bar</th> <th>Z</th> <th>With round gauge</th> </tr> </thead> <tbody> <tr> <td>1 = 30*</td> <td>V = 2*</td> <td>M</td> <td>30 psig; 2 bar; 0.2 MPa</td> </tr> <tr> <td>3 = 60</td> <td>S = 4</td> <td>G</td> <td>60 psig; 4 bar; 0.4 MPa</td> </tr> <tr> <td>5 = 125</td> <td>T = 8</td> <td>J<sup>§</sup></td> <td>125 psig; 8 bar; 0.8 MPa</td> </tr> <tr> <td colspan="4"><b>Without gauge</b></td> </tr> <tr> <td colspan="2"></td> <td>Y</td> <td>30 psig; 2 bar; 0.2 MPa</td> </tr> <tr> <td colspan="2"></td> <td>L</td> <td>60 psig; 4 bar; 0.4 MPa</td> </tr> <tr> <td colspan="2"></td> <td>N</td> <td>125 psig; 8 bar; 0.8 MPa</td> </tr> <tr> <td colspan="2"></td> <td>H<sup>§</sup></td> <td>250 psig; 17 bar; 1.7 MPa</td> </tr> </tbody> </table>		With square gauge		With round gauge		psig	bar	Z	With round gauge	1 = 30*	V = 2*	M	30 psig; 2 bar; 0.2 MPa	3 = 60	S = 4	G	60 psig; 4 bar; 0.4 MPa	5 = 125	T = 8	J <sup>§</sup>	125 psig; 8 bar; 0.8 MPa	<b>Without gauge</b>						Y	30 psig; 2 bar; 0.2 MPa			L	60 psig; 4 bar; 0.4 MPa			N	125 psig; 8 bar; 0.8 MPa			H <sup>§</sup>	250 psig; 17 bar; 1.7 MPa
With square gauge		With round gauge																																															
psig	bar	Z	With round gauge																																														
1 = 30*	V = 2*	M	30 psig; 2 bar; 0.2 MPa																																														
3 = 60	S = 4	G	60 psig; 4 bar; 0.4 MPa																																														
5 = 125	T = 8	J <sup>§</sup>	125 psig; 8 bar; 0.8 MPa																																														
<b>Without gauge</b>																																																	
		Y	30 psig; 2 bar; 0.2 MPa																																														
		L	60 psig; 4 bar; 0.4 MPa																																														
		N	125 psig; 8 bar; 0.8 MPa																																														
		H <sup>§</sup>	250 psig; 17 bar; 1.7 MPa																																														

Most popular.

\* Regulator comes with gauge respective to the adjustment range selected.  
§ Not available with poly bowl with bowl guard.

Global Air Preparation

Introduction

Filters

Coalescers

Regulators

Filter / Regulators

Lubricators

Combinations

Accessories and Kits



For inventory, lead times, and kit lookup, visit [www.pdnplu.com](http://www.pdnplu.com)

**Material Specifications**

Body	Aluminum
Adjustment knob	Acetal
Element retainer / baffle	Acetal
Plastic bowl	Polycarbonate
Metal bowl	Aluminum
Bowl guard	Nylon
Filter element	Sintered polyethylene
Seals	Nitrile
Springs	Steel, stainless steel
Valve assembly	Brass / nitrile
Diaphragm assembly	Nitrile / zinc
Panel nut	Acetal
Sight gauge	Nylon

**Repair and Service Kits**

Plastic bowl / bowl guard manual drain	<b>P32KB00BGM</b>
Metal bowl / sight gauge manual drain	<b>P32KB00BSM</b>
Auto drain	<b>P32KA00DA</b>
5µ particle filter element	<b>P32KA00ESE</b>
Diaphragm repair kit - relieving	<b>P32KB00RB</b>
Diaphragm repair kit - non-relieving	<b>P32KB00RC</b>
Panel mount nut - aluminum	<b>P32KA00MM</b>
Panel mount nut - plastic	<b>P32KA00MP</b>
Angle bracket (fits to panel mount threads)	<b>P32KB00MR</b>
T-bracket (fits to body connector)	<b>P32KA00MB</b>
T-bracket with body connector	<b>P32KA00MT</b>
Body connector	<b>P32KA00CB</b>

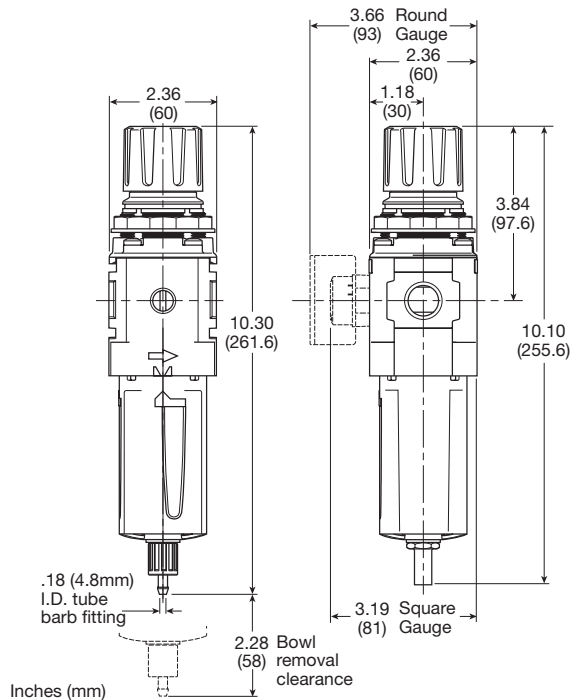

Manual Drain

Automatic Drain

**Flow Charts**

**P32EB 1/4" Filter / Regulator**

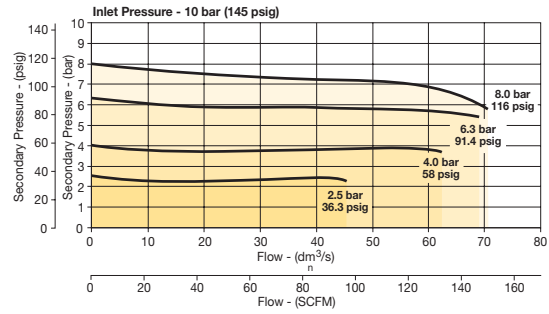

**P32EB3/8" Filter/Regulator**

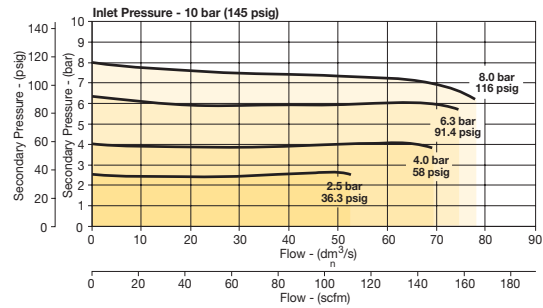

**P32EB 1/2" Filter/Regulator**

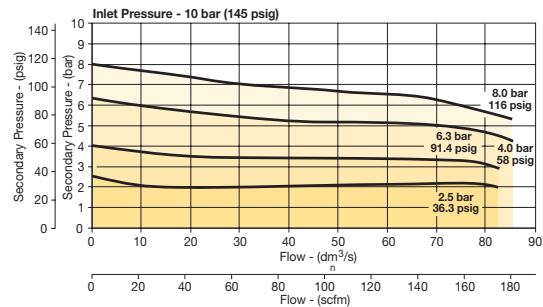

**⚠ WARNING**

**Product rupture can cause serious injury.  
Do not connect regulator to bottled gas.  
Do not exceed Maximum primary pressure rating.**

**CAUTION:**

**REGULATOR PRESSURE ADJUSTMENT** – The working range of knob adjustment is designed to permit outlet pressures within their full range. Pressure adjustment beyond this range is also possible because the knob is not a limiting device. This is a common characteristic of most industrial regulators, and limiting devices may be obtained only by special design. For best performance, regulated pressure should always be set by increasing the pressure up to the desired setting.

**Gauges**

50mm (2") round	0-30 psig / 0-2 bar	<b>K4520N14030</b>
1/4" center back mount	0-60 psig / 0-4 bar	<b>K4520N14060</b>
	0-160 psig / 0-11 bar	<b>K4520N14160</b>
	0-300 psig / 0-20 bar	<b>K4520N14300</b>

For best performance, regulated pressure should always be set by increasing the pressure up to the desired setting.



For inventory, lead time, and kit lookup, visit [www.pdnplu.com](http://www.pdnplu.com)

## P32 Semi-Precision Filter / Regulators – Compact

- Integral 1/4", 3/8" or 1/2" ports (NPT, BSPP & BSPT)
- High efficiency 5 micron element as standard
- Excellent water removal efficiency
- Robust but lightweight aluminum construction
- Positive bayonet latch to ensure correct & safe fitting
- Secondary pressure ranges
- Secondary aspiration plus balanced poppet provides quick response and accurate pressure regulation

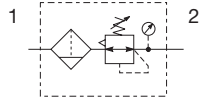

Port size	Description / relieving	Bowl / drain type †	Part number
1/4"	125 psig (8 bar)	Poly / manual	<b>P32EB92EGMPNGP</b>
1/4"	125 psig (8 bar)	Poly / auto	<b>P32EB92EGAPNGP</b>
1/4"	125 psig (8 bar)	Metal / manual	<b>P32EB92ESMPNGP</b>
1/4"	125 psig (8 bar)	Metal / auto	<b>P32EB92ESAPNGP</b>
3/8"	125 psig (8 bar)	Poly / manual	<b>P32EB93EGMPNGP</b>
3/8"	125 psig (8 bar)	Poly / auto	<b>P32EB93EGAPNGP</b>
3/8"	125 psig (8 bar)	Metal / manual	<b>P32EB93ESMPNGP</b>
3/8"	125 psig (8 bar)	Metal / auto	<b>P32EB93ESAPNGP</b>
1/2"	125 psig (8 bar)	Poly / manual	<b>P32EB94EGMPNGP</b>
1/2"	125 psig (8 bar)	Poly / auto	<b>P32EB94EGAPNGP</b>
1/2"	125 psig (8 bar)	Metal / manual	<b>P32EB94ESMPNGP</b>
1/2"	125 psig (8 bar)	Metal / auto	<b>P32EB94ESAPNGP</b>

† For polycarbonate bowl, see caution in Engineering Section A.

### Operating information

Flow capacity*: 1/4, 3/8, 1/2	75 scfm (35 dm <sup>3</sup> /s, ANR)
Effect of supply pressure variation	0.6 psig (0.04 bar) for 25 psig (1.7 bar) change in P1
Operating temperature:	
Plastic bowl	-13°F to 125°F (-25°C to 52°C)
Metal bowl	-13°F to 150°F (-25°C to 65.5°C)
Supply pressure (max):	
Plastic bowl	150 psig (10 bar)
Metal bowl	250 psig (17 bar)
Standard filtration:	5 micron
Useful retention <sup>†</sup> :	1.7 US oz. (51 cm <sup>3</sup> )
Adjusting range pressure:	0 to 30 psig (0 to 2 bar) 0 to 60 psig (0 to 4 bar) 0 to 125 psig (0 to 8 bar) 0 to 250 psig (0 to 17 bar)
Gauge port (2 each):	1/4 NPT, BSPP, BSPT
Weight:	0.53 lb (1.17 kg)

\* Inlet pressure 145 psig (10 bar). Secondary pressure 91.3 psig (6.3 bar) and 14.5 psig (1 bar) pressure drop.

† Useful retention refers to volume below the quiet zone baffle.

Air quality: Within ISO 8573-1: 1991 Class 3 (Particulates)  
Within ISO 8573-1: 2001 Class 6 (Particulates)

### Ordering Information:

**P32EB 9 2 E G M P N G P**

<b>Basic series</b> Global modular compact filter / regulator P32EB	<b>Thread type</b> BSPP 1 BSPT 2 NPT 9	<b>Element</b> 5µ Element E	<b>Port size</b> 1/4 2 3/8 3 1/2 4	<b>Bowl type</b> Poly bowl with bowl guard G Metal bowl without sight gauge M Metal bowl with sight gauge S	<b>Drain type</b> Manual drain M Auto drain A	<b>Adjustment</b> N Non-rising knob T T-Handle	<b>Mounting</b> p Plastic panel mount nut
						<b>Relief</b> P Semi-Precision Relieving T Semi-Precision Non-relieving	
							<b>Adjustment range</b>
							<b>With square gauge</b>
							psig      bar
							Z 30 psig; 2 bar; 0.2 MPa
							M 60 psig; 4 bar; 0.4 MPa
							G 125 psig; 8 bar; 0.8 MPa
							J <sup>§</sup> 250 psig; 17 bar; 1.7 MPa
							<b>Without gauge</b>
							Y 30 psig; 2 bar; 0.2 MPa
							L 60 psig; 4 bar; 0.4 MPa
							N 125 psig; 8 bar; 0.8 MPa
							H <sup>§</sup> 250 psig; 17 bar; 1.7 MPa

\* Regulator comes with gauge respective to the adjustment range selected.  
§ Not available with poly bowl with bowl guard.

Most popular.



For inventory, lead times, and kit lookup, visit [www.pdnplu.com](http://www.pdnplu.com)

**Material Specifications**

Body	Aluminum
Adjustment knob	Acetal
Element retainer / baffle	Acetal
Plastic bowl	Polycarbonate
Metal bowl	Aluminum
Bowl guard	Nylon
Filter element	Sintered polyethylene
Seals	Nitrile
Springs	Steel, stainless steel
Valve assembly	Brass / nitrile
Diaphragm assembly	Nitrile / zinc
Panel nut	Acetal
Sight gauge	Nylon

**Repair and Service Kits**

Plastic bowl / bowl guard manual drain	<b>P32KB00BGM</b>
Metal bowl / sight gauge manual drain	<b>P32KB00BSM</b>
Auto drain	<b>P32KA00DA</b>
5µ particle filter element	<b>P32KA00ESE</b>
Diaphragm repair kit - relieving	<b>P32KB00RB</b>
Diaphragm repair kit - non-relieving	<b>P32KB00RC</b>
Panel mount nut - aluminum	<b>P32KA00MM</b>
Panel mount nut - plastic	<b>P32KA00MP</b>
Angle bracket (fits to panel mount threads)	<b>P32KB00MR</b>
T-bracket (fits to body connector)	<b>P32KA00MB</b>
T-bracket with body connector	<b>P32KA00MT</b>
Body connector	<b>P32KA00CB</b>

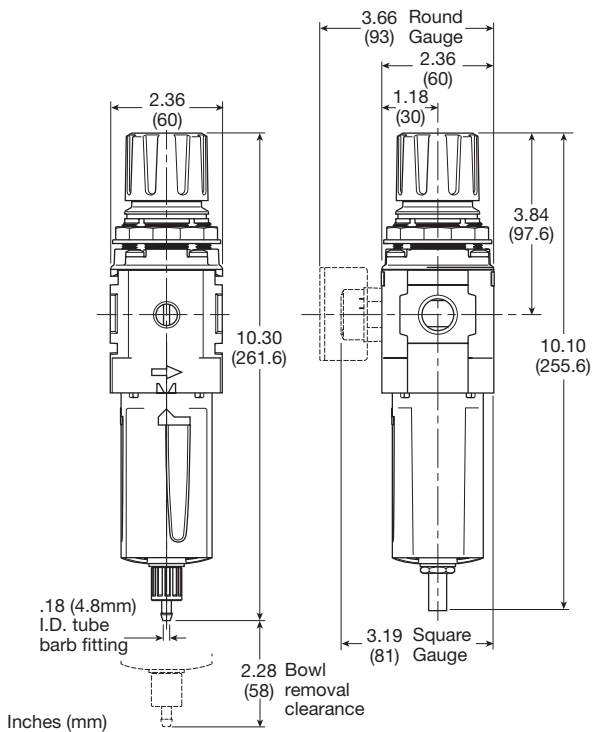

Manual Drain

Automatic Drain

**Flow Charts**

**P32EB 1/4" Filter / Regulator**

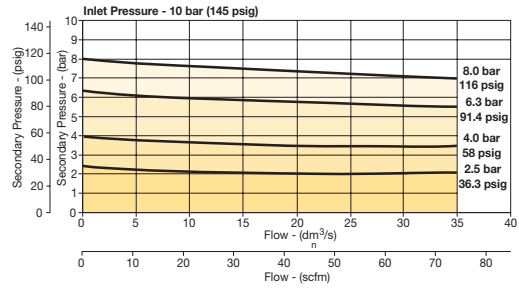

**P32EB 3/8" Filter/Regulator**

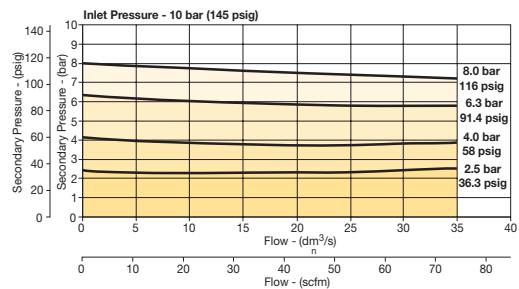

**P32EB 1/2" Filter/Regulator**

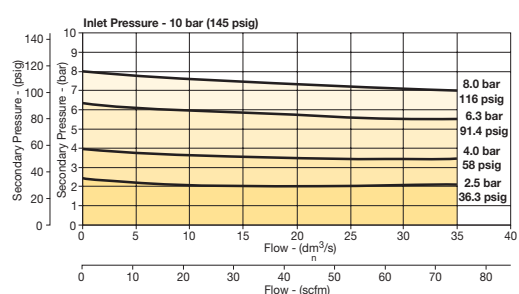

**WARNING**

Product rupture can cause serious injury.  
Do not connect regulator to bottled gas.  
Do not exceed Maximum primary pressure rating.

**CAUTION:**

**REGULATOR PRESSURE ADJUSTMENT** – The working range of knob adjustment is designed to permit outlet pressures within their full range. Pressure adjustment beyond this range is also possible because the knob is not a limiting device. This is a common characteristic of most industrial regulators, and limiting devices may be obtained only by special design. For best performance, regulated pressure should always be set by increasing the pressure up to the desired setting.

**Gauges**

50mm (2") round 1/4" center back mount	0-30 psig / 0-2 bar	<b>K4520N14030</b>
	0-60 psig / 0-4 bar	<b>K4520N14060</b>
	0-160 psig / 0-11 bar	<b>K4520N14160</b>
	0-300 psig / 0-20 bar	<b>K4520N14300</b>

For best performance, regulated pressure should always be set by increasing the pressure up to the desired setting.



For inventory, lead time, and kit lookup, visit [www.pdnplu.com](http://www.pdnplu.com)

## P33 Filter / Regulators – Standard

- Integral 1/2" or 3/4" ports (NPT, BSPP & BSPT)
- High efficiency 5 micron element as standard
- Excellent water removal efficiency
- Robust but lightweight aluminum construction
- Positive bayonet latch to ensure correct & safe fitting
- Secondary pressure ranges
- Secondary aspiration plus balanced poppet provides quick response and accurate pressure regulation

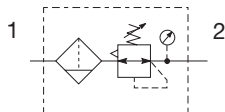

Port size	Description / relieving	Bowl / drain type †	Part number
1/2"	125 psig (8 bar)	Poly / manual	<b>P33EA94EGMBNGP</b>
1/2"	125 psig (8 bar)	Poly / auto	<b>P33EA94EGABNGP</b>
1/2"	125 psig (8 bar)	Metal / manual	<b>P33EA94ESMBNGP</b>
1/2"	125 psig (8 bar)	Metal / auto	<b>P33EA94ESABNGP</b>
3/4"	125 psig (8 bar)	Poly / manual	<b>P33EA96EGMBNGP</b>
3/4"	125 psig (8 bar)	Poly / auto	<b>P33EA96EGABNGP</b>
3/4"	125 psig (8 bar)	Metal / manual	<b>P33EA96ESMBNGP</b>
3/4"	125 psig (8 bar)	Metal / auto	<b>P33EA96ESABNGP</b>

† For polycarbonate bowl, see caution in Engineering Section A.

### Operating information

Flow capacity*:	1/2	200 scfm (94 dm <sup>3</sup> /s, ANR)
	3/4	235 scfm (109 dm <sup>3</sup> /s, ANR)
Operating temperature:		
Plastic bowl		-13°F to 125°F (-25°C to 52°C)
Metal bowl		-13°F to 150°F (-25°C to 65.5°C)
Supply pressure (max):		
Plastic bowl		150 psig (10 bar)
Metal bowl		250 psig (17 bar)
Standard filtration:		5 micron
Useful retention†:		2.8 US oz. (85 cm <sup>3</sup> )
Adjusting range pressure:		0 to 30 psig (0 to 2 bar)
		0 to 60 psig (0 to 4 bar)
		0 to 125 psig (0 to 8 bar)
		0 to 250 psig (0 to 17 bar)
Gauge port (2 each):		1/4 NPT, BSPP, BSPT
Weight:		1.87 psig (8 bar)

\* Inlet pressure 145 psig (10 bar). Secondary pressure 91.3 psig (6.3 bar) and 14.5 psig (1 bar) pressure drop.

† Useful retention refers to volume below the quiet zone baffle.

Air quality: Within ISO 8573-1: 1991 Class 3 (Particulates)  
 Within ISO 8573-1: 2001 Class 6 (Particulates)

### Ordering Information:

Basic series	Thread type	Element	Port size	Bowl type	Relief	Drain type	Adjustment	Mounting	Adjustment range
Global modular standard filter / regulator P33EA	BSPP 1 BSPT 2 NPT 9	5µ Element E	1/2 4 3/4 6	Poly bowl with bowl guard G Metal bowl without sight gauge M Metal bowl with sight gauge S	B Relieving N Non-relieving	M Manual drain A Auto drain	N Non-rising knob	P Plastic panel mount nut	With round gauge Z 30 psig; 2 bar; 0.2 MPa M 60 psig; 4 bar; 0.4 MPa G 125 psig; 8 bar; 0.8 MPa J <sup>§</sup> 250 psig; 17 bar; 1.7 MPa Without gauge Y 30 psig; 2 bar; 0.2 MPa L 60 psig; 4 bar; 0.4 MPa N 125 psig; 8 bar; 0.8 MPa H <sup>§</sup> 250 psig; 17 bar; 1.7 MPa

§ Not available with poly bowl with bowl guard.

Most popular.



For inventory, lead times, and kit lookup, visit [www.pdnplu.com](http://www.pdnplu.com)



**Material Specifications**

Body	Aluminum
Adjustment knob	Acetal
Body cap	ABS
Element retainer / baffle	Acetal
Plastic bowl	Polycarbonate
Metal bowl	Aluminum
Filter element	Sintered Polyethylene
Seals	Nitrile
Springs	Steel, stainless steel
Valve assembly	Brass / nitrile
Diaphragm assembly	Nitrile / zinc
Panel nut	Acetal
Sight gauge	Nylon

**Repair and Service Kits**

Plastic bowl / bowl guard, manual drain	<b>P33KA00BGM</b>
Metal bowl / sight gauge, manual drain	<b>P33KA00BSM</b>
Auto drain	<b>P32KA00DA</b>
5µ particle filter element	<b>P33KA00ESE</b>
Diaphragm repair kit - Relieving	<b>P33KA00RB</b>
Diaphragm repair kit - Non-relieving	<b>P33KA00RC</b>
Panel mount nut - Aluminum	<b>P33KA00MM</b>
Panel mount nut - Plastic	<b>P33KA00MP</b>
Angle bracket (fits to panel mount threads)	<b>P33KA00MR</b>
T-bracket (fits to body connector)	<b>P32KA00MB</b>
T-bracket with body connector	<b>P32KA00MT</b>
Body connector	<b>P32KA00CB</b>

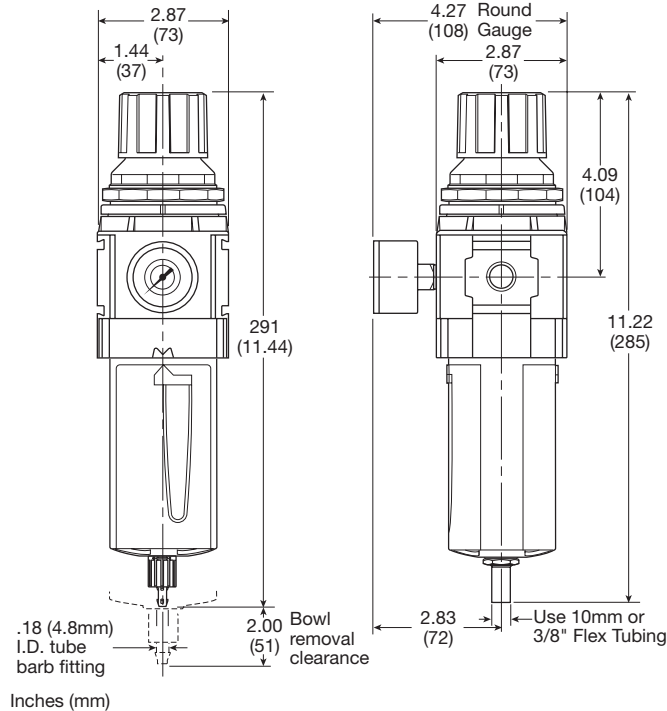

**Flow Charts**

**P33EA 1/2" Filter / Regulator**

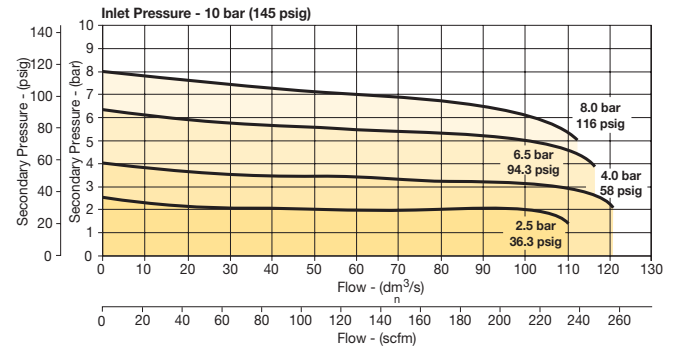

**P33EA 3/4" Filter/Regulator**

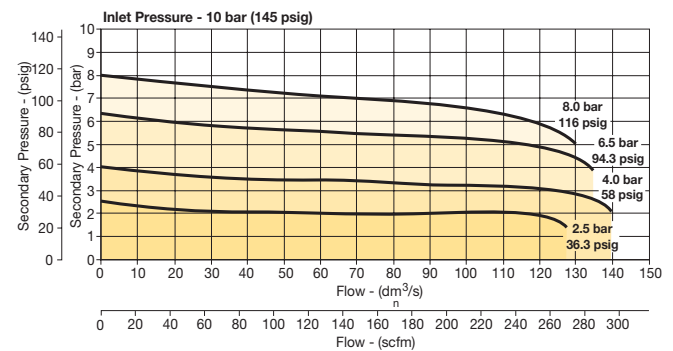

**WARNING**  
 Product rupture can cause serious injury.  
 Do not connect regulator to bottled gas.  
 Do not exceed Maximum primary pressure rating.

**CAUTION:**

**REGULATOR PRESSURE ADJUSTMENT** – The working range of knob adjustment is designed to permit outlet pressures within their full range. Pressure adjustment beyond this range is also possible because the knob is not a limiting device. This is a common characteristic of most industrial regulators, and limiting devices may be obtained only by special design. For best performance, regulated pressure should always be set by increasing the pressure up to the desired setting.

**Gauges**

<b>50mm (2") round</b>	0-30 psig / 0-2 bar	<b>K4520N14030</b>
<b>1/4" center back mount</b>	0-60 psig / 0-4 bar	<b>K4520N14060</b>
	0-160 psig / 0-11 bar	<b>K4520N14160</b>
	0-300 psig / 0-20 bar	<b>K4520N14300</b>

For best performance, regulated pressure should always be set by increasing the pressure up to the desired setting.

Manual Drain

Automatic Drain



For inventory, lead time, and kit lookup, visit [www.pdnplu.com](http://www.pdnplu.com)

## P31 Lubricators – Mini

- Integral 1/4" ports (NPT, BSPP & BSPT)
- Robust but lightweight aluminum construction
- Proportional oil delivery over a wide range of air flows
- Finger tip ratchet control for precise oil drip rate adjustment

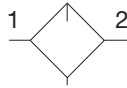

Lubricator with drain

Port size	Description †	Part number
1/4"	Poly bowl - No drain	<b>P31LB92LGNN</b>
1/4"	Metal bowl - No drain	<b>P31LB92LMNN</b>

† For polycarbonate bowl, see caution in Engineering Section A.

### Operating information

Flow capacity*:	
1/4	52 scfm (25 dm <sup>3</sup> /s, ANR)
Operating temperature:	
Plastic bowl	14°F to 125°F (-10°C to 52°C)
Metal bowl	14°F to 150°F (-10°C to 65.5°C)
Supply pressure (max):	
Plastic bowl	150 psig (10 bar)
Metal bowl	250 psig (17 bar)
Bowl capacity:	0.6 US oz. (18 cm <sup>3</sup> )
Weight:	0.29 lb (0.13 kg)
* Inlet pressure 91.3 psig (6.3 bar). Pressure drop 4.9 psig (0.34 bar).	

### Ordering Information:

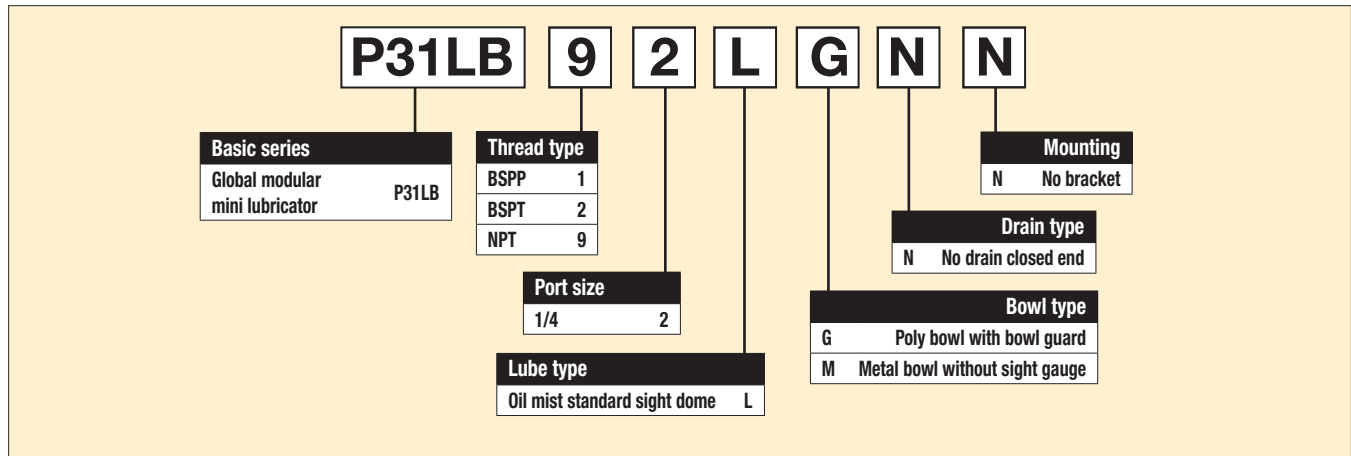

### Suggested Lubricant .....F442 Oil

Petroleum based oil of 100 to 200 SUS viscosity at 100°F (38°C) and an aniline point greater than 200°F (93°C)  
 (DO NOT USE OILS WITH ADDITIVES, COMPOUNDED OILS CONTAINING SOLVENTS, GRAPHITE, DETERGENTS, OR SYNTHETIC OILS.)

Most popular.



For inventory, lead times, and kit lookup, visit [www.pdnplu.com](http://www.pdnplu.com)

**B**  
 Global Air Preparation  
 Introduction  
 Filters  
 Coalescers  
 Regulators  
 Filter / Regulators  
 Lubricators  
 Combinations  
 Accessories and Kits

## Mini Lubricators

### Material Specifications

Body	Aluminum
Body cap	ABS
Plastic bowl	Polycarbonate
Metal bowl	Aluminum
Seals	Nitrile
Sight dome	Polycarbonate
Suggested lubricant	ISO / ASTM VG32
Pick-up filter	Sintered bronze

### Repair and Service Kits

Plastic bowl / bowl guard no drain	<b>P31KB00BGN</b>
Metal bowl / w/o sight gauge no drain	<b>P31KB00BMN</b>
Drip control assembly	<b>P32KA00PG</b>
Fill plug	<b>P31KA00PL</b>
C-bracket (fits to body)	<b>P31KA00MW</b>
T-bracket with body connector	<b>P31KA00MT</b>
Body connector	<b>P31KA00CB</b>
Oil (1 quart)	<b>F442001</b>
Oil (1 gallon)	<b>F442002</b>
Oil (12 quart case)	<b>F442003</b>
Oil (4 gallon case)	<b>F442005</b>

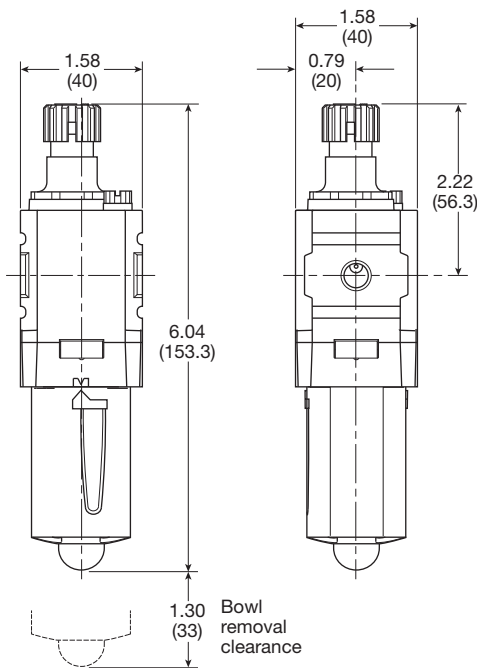

Inches (mm)

## Air Preparation Products Global Air Preparation

### Flow Charts

#### P31LB 1/4" Lubricator

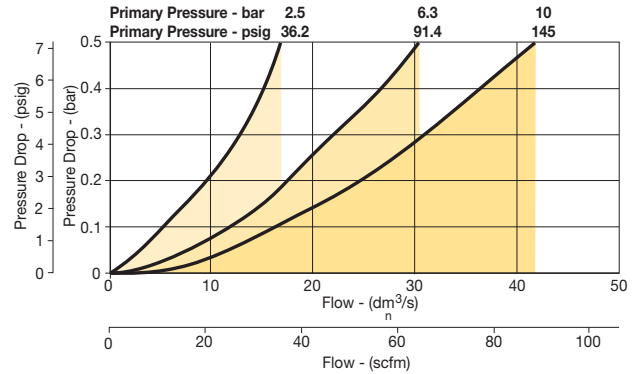

**B**

Global Air Preparation

Introduction

Filters

Coalescers

Regulators

Filter/Regulators

Lubricators

Combinations

Accessories and Kits



For inventory, lead time, and kit lookup, visit [www.pdnplu.com](http://www.pdnplu.com)

## P32 Lubricators – Compact

- Integral 1/4", 3/8" or 1/2" ports (NPT, BSPP & BSPT)
- Robust but lightweight aluminum construction
- Proportional oil delivery over a wide range of air flows
- Finger tip ratchet control for precise oil drip rate adjustment
- Fill from top under system pressure

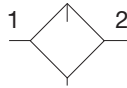

Lubricator with drain



### Operating information

Flow capacity*:	
1/4	38 scfm (17 dm <sup>3</sup> /s, ANR)
3/8	70 scfm (33 dm <sup>3</sup> /s, ANR)
1/2	90 scfm (42 dm <sup>3</sup> /s, ANR)
Operating temperature:	
Plastic bowl	14°F to 125°F (-10°C to 52°C)
Metal bowl	14°F to 150°F (-10°C to 65.5°C)
Supply pressure (max):	
Plastic bowl	150 psig (10 bar)
Metal bowl	250 psig (17 bar)
Bowl capacity:	4.09 US oz. (121 cm <sup>3</sup> )
Weight:	0.68 lb (0.31 kg)
* Inlet pressure 91.3 psig (6.3 bar). Pressure drop 4.9 psig (0.34 bar).	

Port size	Description †	Part number
1/4"	Poly bowl - No drain	<b>P32LB92LGNN</b>
1/4"	Metal bowl - No drain	<b>P32LB92LSNN</b>
3/8"	Poly bowl - No drain	<b>P32LB93LGNN</b>
3/8"	Metal bowl - No drain	<b>P32LB93LSNN</b>
1/2"	Poly bowl - No drain	<b>P32LB94LGNN</b>
1/2"	Metal bowl - No drain	<b>P32LB94LSNN</b>

† For polycarbonate bowl, see caution in Engineering Section A.

### Ordering Information:

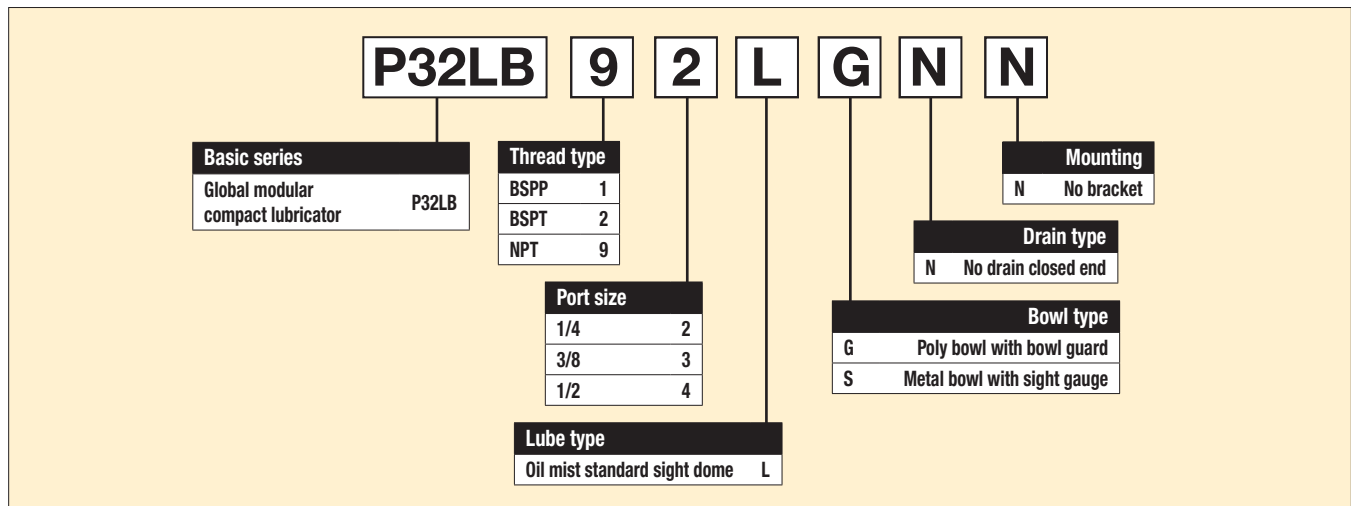

**Suggested Lubricant** ..... **F442 Oil**  
 Petroleum based oil of 100 to 200 SUS viscosity at 100°F (38°C) and an aniline point greater than 200°F (93°C)  
 (DO NOT USE OILS WITH ADDITIVES, COMPOUNDED OILS CONTAINING SOLVENTS, GRAPHITE, DETERGENTS, OR SYNTHETIC OILS.)

Most popular.



For inventory, lead times, and kit lookup, visit [www.pdnplu.com](http://www.pdnplu.com)

**P** Global Air Preparation  
 Introduction  
 Filters  
 Coalescers  
 Regulators  
 Filter / Regulators  
 Lubricators  
 Combinations  
 Accessories and Kits

**Material Specifications**

Body	Aluminum
Body cap	ABS
Plastic bowl	Polycarbonate
Metal bowl	Aluminum
Seals	Nitrile
Sight dome	Polycarbonate
Sight gauge	Nylon
Suggested lubricant	ISO / ASTM VG32
Pick-up filter	Sintered bronze

**Repair and Service Kits**

Plastic bowl / bowl guard no drain	<b>P32KB00BGN</b>
Metal bowl / w/o sight gauge no drain	<b>P32KB00BMN</b>
Metal bowl / Sight gauge no drain	<b>P32KB00BSN</b>
Drip control assembly	<b>P32KA00PG</b>
Fill plug	<b>P32KA00PL</b>
L-bracket (fits to body)	<b>P32KA00ML</b>
T-bracket (fits to body connector)	<b>P32KA00MB</b>
T-bracket with body connector	<b>P32KA00MT</b>
Body connector	<b>P32KA00CB</b>
Oil (1 quart)	<b>F442001</b>
Oil (1 gallon)	<b>F442002</b>
Oil (12 quart case)	<b>F442003</b>
Oil (4 gallon case)	<b>F442005</b>

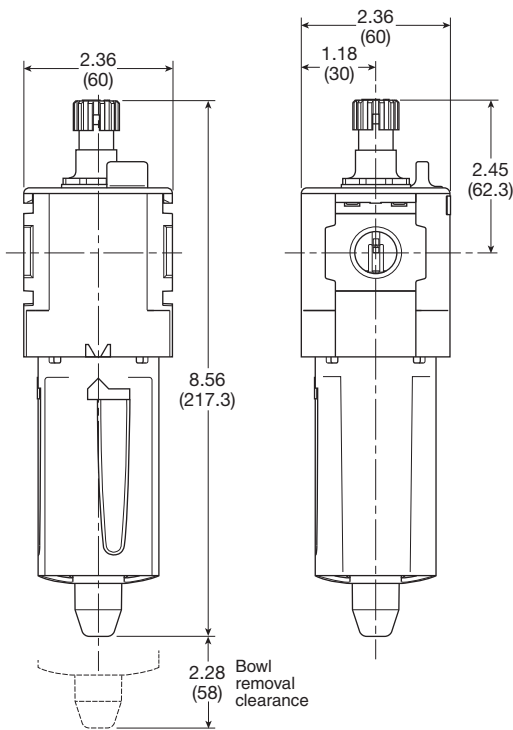

Inches (mm)

**Flow Charts**

**P32LB 1/4" Lubricator**

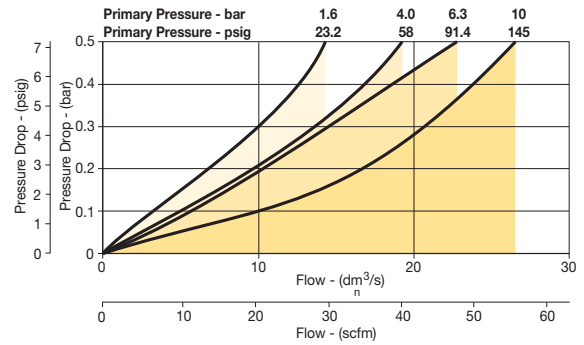

**P32LB 3/8" Lubricator**

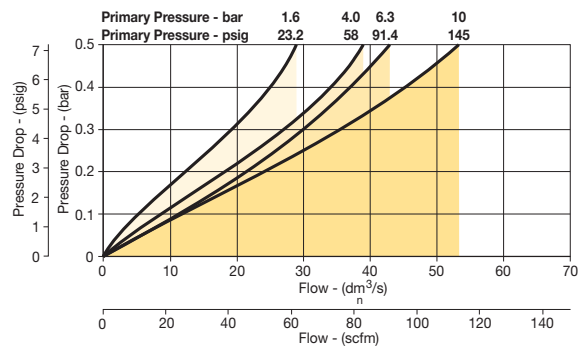

**P32LB 1/2" Lubricator**

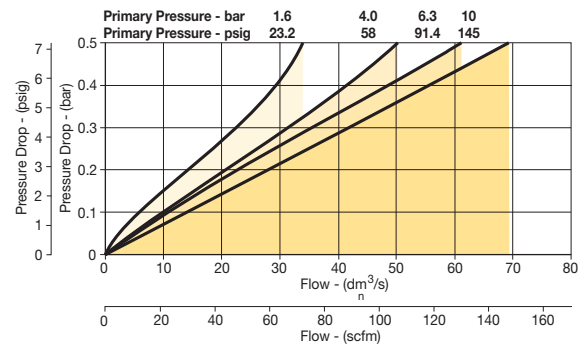

**B**

Global Air Preparation

Introduction

Filters

Coalescers

Regulators

Filter/Regulators

Lubricators

Combinations

Accessories and Kits



For inventory, lead time, and kit lookup, visit [www.pdnplu.com](http://www.pdnplu.com)

## P33 Lubricators – Standard

- Integral 1/2" or 3/4" ports (NPT, BSPP & BSPT)
- Robust but lightweight aluminum construction
- Proportional oil delivery over a wide range of air flows
- Finger tip ratchet control for precise oil drip rate adjustment
- Fill from top under system pressure

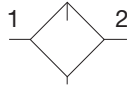

Lubricator with drain



### Operating information

Flow capacity*:	
1/2	110 scfm (52 dm <sup>3</sup> /s, ANR)
3/4	150 scfm (71 dm <sup>3</sup> /s, ANR)
Operating temperature:	
Plastic bowl	14°F to 125°F (-10°C to 52°C)
Metal bowl	14°F to 150°F (-10°C to 65.5°C)
Supply pressure (max):	
Plastic bowl	150 psig (10 bar)
Metal bowl	250 psig (17 bar)
Bowl capacity:	6.1 US oz. (181 cm <sup>3</sup> )
Weight:	1.04 lb (0.47 kg)
* Inlet pressure 91.3 psig (6.3 bar). Pressure drop 4.9 psig (0.34 bar).	

Port size	Description †	Part number
1/2"	Poly bowl - No drain	<b>P33LA94LGNN</b>
1/2"	Metal bowl - No drain	<b>P33LA94LSNN</b>
3/4"	Poly bowl - No drain	<b>P33LA96LGNN</b>
3/4"	Metal bowl - No drain	<b>P33LA96LSNN</b>

† For polycarbonate bowl, see caution in Engineering Section A.

### Ordering Information:

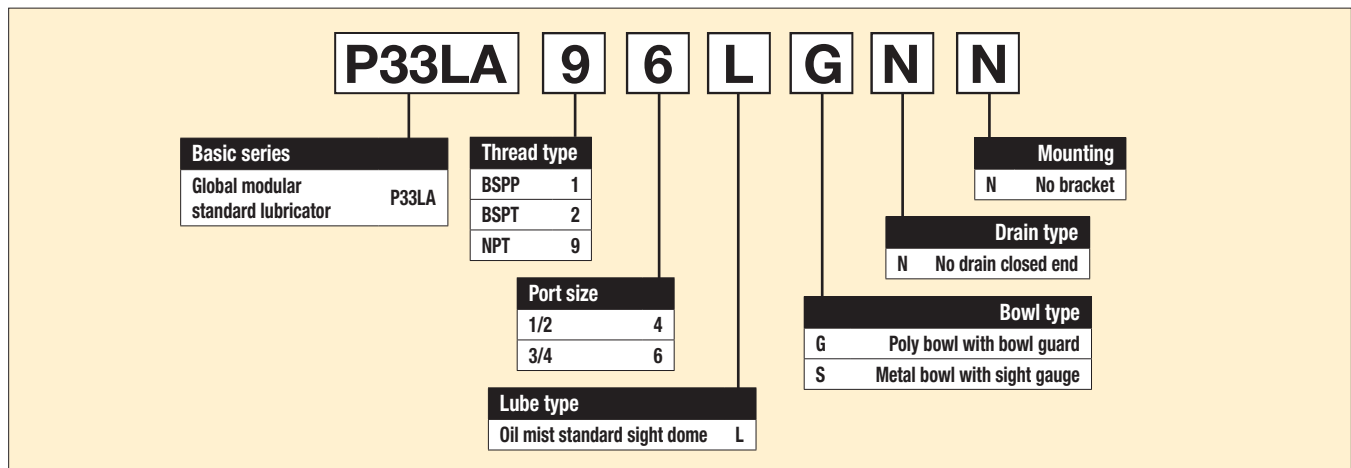

**Suggested Lubricant** .....F442 Oil  
 Petroleum based oil of 100 to 200 SUS viscosity at 100°F (38°C) and an aniline point greater than 200°F (93°C)  
 (DO NOT USE OILS WITH ADDITIVES, COMPOUNDED OILS CONTAINING SOLVENTS, GRAPHITE, DETERGENTS, OR SYNTHETIC OILS.)

Most popular.



For inventory, lead times, and kit lookup, visit [www.pdnplu.com](http://www.pdnplu.com)

**P** Global Air Preparation  
 Introduction  
 Filters  
 Coalescers  
 Regulators  
 Filter / Regulators  
 Lubricators  
 Combinations  
 Accessories and Kits

**Material Specifications**

Body	Aluminum
Body cap	ABS
Plastic bowl	Polycarbonate
Metal bowl	Aluminum
Seals	Nitrile
Sight dome	Polycarbonate
Sight gauge	Nylon
Suggested lubricant	ISO / ASTM VG32
Pick-up filter	Sintered bronze

**Repair and Service Kits**

Plastic bowl / bowl guard no drain	<b>P33KA00BGN</b>
Metal bowl / w/o sight gauge no drain	<b>P33KA00BMN</b>
Metal bowl / sight gauge no drain	<b>P33KA00BSN</b>
Drip control assembly	<b>P32KA00PG</b>
Fill plug	<b>P32KA00PL</b>
L-bracket (fits to body)	<b>P33KA00ML</b>
T-bracket (fits to body connector)	<b>P32KA00MB</b>
T-bracket with body connector	<b>P32KA00MT</b>
Body connector	<b>P32KA00CB</b>
Oil (1 quart)	<b>F442001</b>
Oil (1 gallon)	<b>F442002</b>
Oil (12 quart case)	<b>F442003</b>
Oil (4 gallon case)	<b>F442005</b>

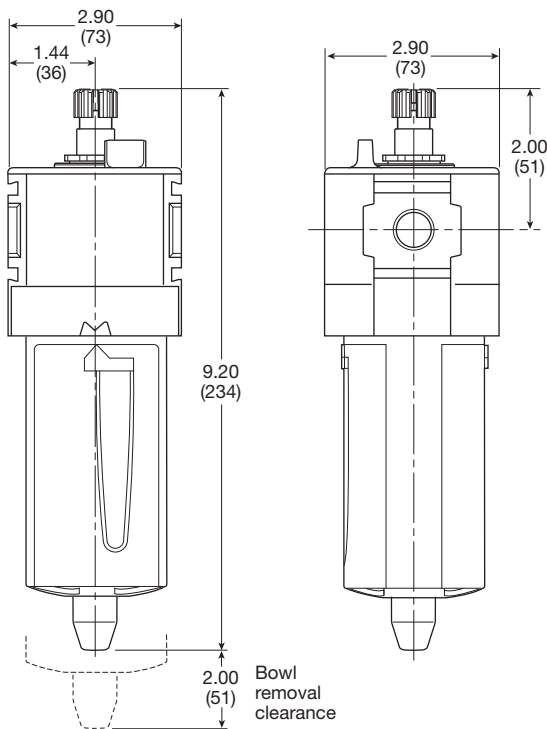

Inches (mm)

**Flow Charts**

**P33LA 1/2" Lubricator**

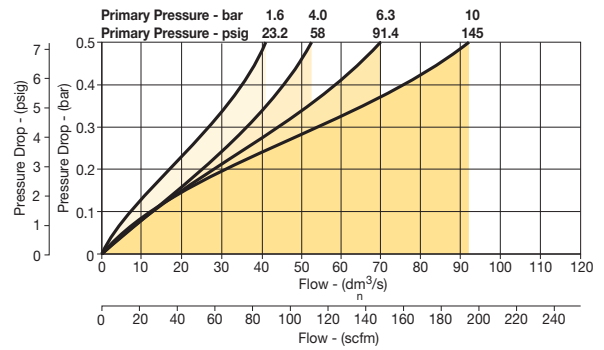

**P33LA 3/4" Lubricator**

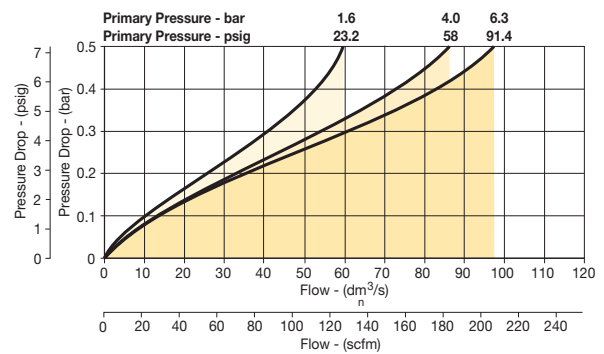

**B**

Global Air Preparation

Introduction

Filters

Coalescers

Regulators

Filter/Regulators

Lubricators

Combinations

Accessories and Kits



For inventory, lead time, and kit lookup, visit [www.pdnplu.com](http://www.pdnplu.com)

**Popular Combinations:** Inlet pressure 145 psig (10 bar), secondary pressure 91.3 psig (6.3 bar), 14.5 psig (1 bar) pressure drop.

**B**  
Global Air Preparation  
Introduction  
Filters  
Coalescers  
Regulators  
Filter / Regulators  
Lubricators  
Combinations  
Accessories and Kits



**Filter + Regulator + Lubricator Combinations, poly bowl  
5 micron element, 116 psig (8 bar) regulator + gauge and wall mounting brackets**

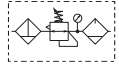

Port size	Flow	Manual drain	Pulse drain
1/4"	27 scfm (13 dm³/s, ANR)	<b>P31CB92GEMN5LNW</b>	<b>P31CB92GEBN5LNW</b>



**Filter/Regulator + Lubricator Combinations, poly bowl  
5 micron element, 116 psig (8 bar) regulator + gauge and wall mounting brackets**

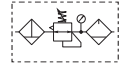

Port size	Flow	Manual drain	Pulse drain
1/4"	28 scfm (14 dm³/s, ANR)	<b>P31CA92GEMN5LNW</b>	<b>P31CA92GEBN5LNW</b>



**Ball Valve + Filter + Regulator + Lubricator Combinations, poly bowl  
5 micron element, 116 psig (8 bar) regulator + gauge and wall mounting brackets**

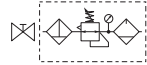

Port size	Flow	Manual drain	Pulse drain
1/4"	27 scfm (13 dm³/s, ANR)	<b>P31QB92GEMN5LNW</b>	<b>P31QB92GEBN5LNW</b>



**Ball Valve + Filter/Regulator + Lubricator Combinations, poly bowl  
5 micron element, 116 psig (8 bar) regulator + gauge and wall mounting brackets**

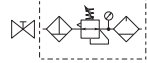

Port size	Flow	Manual drain	Pulse drain
1/4"	28 scfm (14 dm³/s, ANR)	<b>P31QA92GEMN5LNW</b>	<b>P31QA92GEBN5LNW</b>

**Filter / Regulator coding**  
(use with codes: A M)

Filter coding (use with combo codes: B F G). For multiple filters, repeat as needed.	Regulator coding (use with combo code: B)	Lubricator coding (use with combo codes: A B)	Assembly configuration																
<p><b>P31</b></p> <p><b>Combination</b> B/V + Combination <b>Q</b> Combination + B/V <b>X</b> Combination <b>C</b></p> <p>B/V = Ball valve</p> <p><b>Combination type*</b></p> <table border="1"> <tr> <td>F/R+L <b>A</b></td> <td>F+Fc+Fa <b>G</b></td> </tr> <tr> <td>F+R+L <b>B</b></td> <td>F/R+Fc <b>M</b></td> </tr> <tr> <td>F+Fc <b>F</b></td> <td></td> </tr> </table> <p>* Combination type F = 5µ Fc1 = 1µ Fc = .01µ Fa = Adsorber</p> <p><b>Thread type</b> BSPP <b>1</b> BSPT <b>2</b> NPT <b>9</b></p> <p><b>Port size</b> 1/4" <b>2</b></p> <p><b>Bowl type</b> Poly bowl with bowl guard † <b>G</b> Metal bowl without sight gauge <b>M</b></p> <p><b>Note:</b> All bowl types are the same for each component <b>Example:</b> If a "G" is specified for a F+L, both units would get a poly bowl with bowl guard. † For polycarbonate bowl, see caution in Engineering Section A.</p> <p><b>Element</b> 5µ Element <b>E</b> 0.01µ Element <b>C</b> 1µ Element <b>9</b> Adsorber <b>A</b></p> <p><b>Drain type</b> Manual drain <b>M</b> Pulse drain <b>B</b></p>	F/R+L <b>A</b>	F+Fc+Fa <b>G</b>	F+R+L <b>B</b>	F/R+Fc <b>M</b>	F+Fc <b>F</b>		<p><b>E M</b></p> <p><b>Relief / Adjustment</b> Non-rising knob <b>N</b></p> <p><b>Adjustment range</b></p> <table border="1"> <thead> <tr> <th>Without gauge</th> <th>With square gauge</th> </tr> </thead> <tbody> <tr> <td>30 psig; 2 bar; 0.2 MPa <b>Z</b></td> <td>30* = 1 2* = V</td> </tr> <tr> <td>60 psig; 4 bar; 0.4 MPa <b>M</b></td> <td>60 = 3 4 = S</td> </tr> <tr> <td>125 psig; 8 bar; 0.8 MPa <b>G</b></td> <td>125 = 5 8 = T</td> </tr> <tr> <td>232 psig; 16 bar; 1.6 MPa <b>J</b>§</td> <td></td> </tr> </tbody> </table>	Without gauge	With square gauge	30 psig; 2 bar; 0.2 MPa <b>Z</b>	30* = 1 2* = V	60 psig; 4 bar; 0.4 MPa <b>M</b>	60 = 3 4 = S	125 psig; 8 bar; 0.8 MPa <b>G</b>	125 = 5 8 = T	232 psig; 16 bar; 1.6 MPa <b>J</b> §		<p><b>L N</b></p> <p><b>Lub type</b> Oil mist standard sight dome <b>L</b></p> <p><b>Drain type</b> No drain; closed end <b>N</b></p>	<p><b>W</b></p> <p><b>Mounting</b> No bracket <b>A</b> Port blocks <b>C*</b> Port blocks &amp; wall brkt <b>D*</b> Wall bracket <b>W</b></p> <p>* For 3/8" Port Blocks please order separately. See Kits section. § Not available with poly bowl with bowl guard.</p>
F/R+L <b>A</b>	F+Fc+Fa <b>G</b>																		
F+R+L <b>B</b>	F/R+Fc <b>M</b>																		
F+Fc <b>F</b>																			
Without gauge	With square gauge																		
30 psig; 2 bar; 0.2 MPa <b>Z</b>	30* = 1 2* = V																		
60 psig; 4 bar; 0.4 MPa <b>M</b>	60 = 3 4 = S																		
125 psig; 8 bar; 0.8 MPa <b>G</b>	125 = 5 8 = T																		
232 psig; 16 bar; 1.6 MPa <b>J</b> §																			



For inventory, lead times, and kit lookup, visit [www.pdnplu.com](http://www.pdnplu.com)



**Popular Combinations:** Inlet pressure 145 psig (10 bar), secondary pressure 91.3 psig (6.3 bar), 14.5 psig (1 bar) pressure drop.

**B**  
Global Air Preparation  
Introduction  
Filters  
Coalescers  
Regulators  
Filter/Regulators  
Lubricators  
Combinations  
Accessories and Kits



**Filter + Regulator + Lubricator Combinations, poly bowl  
5 micron element, 116 psig (8 bar) regulator + gauge and wall mounting brackets**

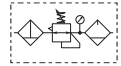

Port size	Flow	Manual drain	Auto drain
1/4"	42 scfm (20 dm <sup>3</sup> /s, ANR)	<b>P32CB92GEMNGLNW</b>	<b>P32CB92GEANGLNW</b>
3/8"	68 scfm (32 dm <sup>3</sup> /s, ANR)	<b>P32CB93GEMNGLNW</b>	<b>P32CB93GEANGLNW</b>
1/2"	85 scfm (40 dm <sup>3</sup> /s, ANR)	<b>P32CB94GEMNGLNW</b>	<b>P32CB94GEANGLNW</b>



**Filter/Regulator + Lubricator Combinations, poly bowl  
5 micron element, 116 psig (8 bar) regulator + gauge and wall mounting brackets**

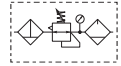

Port size	Flow	Manual drain	Auto drain
1/4"	45 scfm (22 dm <sup>3</sup> /s, ANR)	<b>P32CA92GEMNGLNW</b>	<b>P32CA92GEANGLNW</b>
3/8"	70 scfm (33 dm <sup>3</sup> /s, ANR)	<b>P32CA93GEMNGLNW</b>	<b>P32CA93GEANGLNW</b>
1/2"	90 scfm (43 dm <sup>3</sup> /s, ANR)	<b>P32CA94GEMNGLNW</b>	<b>P32CA94GEANGLNW</b>



**Ball Valve + Filter + Regulator + Lubricator Combinations, poly bowl  
5 micron element, 116 psig (8 bar) regulator + gauge and wall mounting brackets**

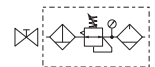

Port size	Flow	Manual drain	Auto drain
1/4"	42 scfm (20 dm <sup>3</sup> /s, ANR)	<b>P32QB92GEMNGLNW</b>	<b>P32QB92GEANGLNW</b>
3/8"	68 scfm (32 dm <sup>3</sup> /s, ANR)	<b>P32QB93GEMNGLNW</b>	<b>P32QB93GEANGLNW</b>
1/2"	85 scfm (40 dm <sup>3</sup> /s, ANR)	<b>P32QB94GEMNGLNW</b>	<b>P32QB94GEANGLNW</b>



**Ball Valve + Filter/Regulator + Lubricator Combinations, poly bowl  
5 micron element, 116 psig (8 bar) regulator + gauge and wall mounting brackets**

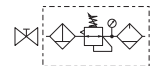

Port size	Flow	Manual drain	Auto drain
1/4"	45 scfm (22 dm <sup>3</sup> /s, ANR)	<b>P32QA92GEMNGLNW</b>	<b>P32QA92GEANGLNW</b>
3/8"	70 scfm (33 dm <sup>3</sup> /s, ANR)	<b>P32QA93GEMNGLNW</b>	<b>P32QA93GEANGLNW</b>
1/2"	90 scfm (43 dm <sup>3</sup> /s, ANR)	<b>P32QA94GEMNGLNW</b>	<b>P32QA94GEANGLNW</b>

**Filter / Regulator coding**  
(use with codes: A M)

Filter coding (use with combo codes: B F G, For multiple filters, repeat as needed.)	Regulator coding (use with combo code: B)	Lubricator coding (use with combo codes: A B)	Assembly configuration
-----------------------------------------------------------------------------------------------	----------------------------------------------	-----------------------------------------------------	---------------------------

<p><b>P32</b></p> <p><b>Combination</b></p> <p>B/V + Combination <b>Q</b></p> <p>Combination + B/V <b>X</b></p> <p>Combination <b>C</b></p> <p>B/V = Ball valve</p> <p><b>Combination type*</b></p> <table border="1"> <tr> <td>F/R+L <b>A</b></td> <td>F+Fc+Fa <b>G</b></td> </tr> <tr> <td>F+R+L <b>B</b></td> <td>F/R+Fc <b>M</b></td> </tr> <tr> <td>F+Fc <b>F</b></td> <td></td> </tr> </table> <p>* Combination type F = 5µ Fc = 1µ Fa = Adsorber</p> <p>† For polycarbonate bowl, see caution in Engineering Section A.</p> <p><b>Bowl type</b></p> <table border="1"> <tr> <td>Poly bowl with bowl guard ‡</td> <td><b>G</b></td> </tr> <tr> <td>Metal bowl without sight gauge</td> <td><b>M*</b></td> </tr> <tr> <td>Metal bowl with sight gauge</td> <td><b>S</b></td> </tr> </table> <p>* Not available when using lubricator. <b>Note:</b> All bowl types are the same for each component. <b>Example:</b> If a "G" is specified for a F+L, both units would get a poly bowl with bowl guard.</p>	F/R+L <b>A</b>	F+Fc+Fa <b>G</b>	F+R+L <b>B</b>	F/R+Fc <b>M</b>	F+Fc <b>F</b>		Poly bowl with bowl guard ‡	<b>G</b>	Metal bowl without sight gauge	<b>M*</b>	Metal bowl with sight gauge	<b>S</b>	<p><b>C</b></p> <p><b>Thread type</b></p> <table border="1"> <tr> <td>BSPP</td> <td><b>1</b></td> </tr> <tr> <td>BSPT</td> <td><b>2</b></td> </tr> <tr> <td>NPT</td> <td><b>9</b></td> </tr> </table> <p><b>Port size</b></p> <table border="1"> <tr> <td>1/4</td> <td><b>2*</b></td> </tr> <tr> <td>3/8</td> <td><b>3</b></td> </tr> <tr> <td>1/2</td> <td><b>4</b></td> </tr> </table> <p>* Order combo Q or X: ball valve (BV) comes with 3/8 ports.</p>	BSPP	<b>1</b>	BSPT	<b>2</b>	NPT	<b>9</b>	1/4	<b>2*</b>	3/8	<b>3</b>	1/2	<b>4</b>	<p><b>9 4 G</b></p> <p><b>Element</b></p> <table border="1"> <tr> <td>0.01µ Element</td> <td><b>C</b></td> </tr> <tr> <td>0.01µ Element with dpi</td> <td><b>D*</b></td> </tr> <tr> <td>5µ Element</td> <td><b>E</b></td> </tr> <tr> <td>5µ Element with dpi</td> <td><b>F*</b></td> </tr> <tr> <td>1µ Element</td> <td><b>9</b></td> </tr> <tr> <td>1µ Element with dpi</td> <td><b>Q*</b></td> </tr> <tr> <td>Adsorber</td> <td><b>A</b></td> </tr> </table> <p>* Not available with F/R.</p> <p><b>Drain type</b></p> <table border="1"> <tr> <td>Auto drain</td> <td><b>A</b></td> </tr> <tr> <td>Manual drain</td> <td><b>M</b></td> </tr> </table>	0.01µ Element	<b>C</b>	0.01µ Element with dpi	<b>D*</b>	5µ Element	<b>E</b>	5µ Element with dpi	<b>F*</b>	1µ Element	<b>9</b>	1µ Element with dpi	<b>Q*</b>	Adsorber	<b>A</b>	Auto drain	<b>A</b>	Manual drain	<b>M</b>	<p><b>E M</b></p> <p><b>Relief / Adjustment</b></p> <p>Non-rising knob relieving <b>N</b></p> <p><b>Adjustment range</b></p> <table border="1"> <tr> <th colspan="2">With round gauge</th> </tr> <tr> <td>30 psig; 2 bar; 0.2 MPa</td> <td><b>Z</b></td> </tr> <tr> <td>60 psig; 4 bar; 0.4 MPa</td> <td><b>M</b></td> </tr> <tr> <td>125 psig; 8 bar; 0.8 MPa</td> <td><b>G</b></td> </tr> <tr> <td>250 psig; 17 bar; 1.7 MPa</td> <td><b>J<sup>§</sup></b></td> </tr> <tr> <th colspan="2">Without gauge</th> </tr> <tr> <td>30 psig; 2 bar; 0.2 MPa</td> <td><b>Y</b></td> </tr> <tr> <td>60 psig; 4 bar; 0.4 MPa</td> <td><b>L</b></td> </tr> <tr> <td>125 psig; 8 bar; 0.8 MPa</td> <td><b>N</b></td> </tr> <tr> <td>250 psig; 17 bar; 1.7 MPa</td> <td><b>H<sup>§</sup></b></td> </tr> </table> <p><b>With square gauge</b></p> <table border="1"> <tr> <td>30* = 1</td> <td>2* = V</td> </tr> <tr> <td>60 = 3</td> <td>4 = S</td> </tr> <tr> <td>125 = 5</td> <td>8 = T</td> </tr> </table>	With round gauge		30 psig; 2 bar; 0.2 MPa	<b>Z</b>	60 psig; 4 bar; 0.4 MPa	<b>M</b>	125 psig; 8 bar; 0.8 MPa	<b>G</b>	250 psig; 17 bar; 1.7 MPa	<b>J<sup>§</sup></b>	Without gauge		30 psig; 2 bar; 0.2 MPa	<b>Y</b>	60 psig; 4 bar; 0.4 MPa	<b>L</b>	125 psig; 8 bar; 0.8 MPa	<b>N</b>	250 psig; 17 bar; 1.7 MPa	<b>H<sup>§</sup></b>	30* = 1	2* = V	60 = 3	4 = S	125 = 5	8 = T	<p><b>N G</b></p> <p><b>Lub type</b></p> <p>Oil mist standard sight dome <b>L</b></p> <p><b>Drain type</b></p> <p>No drain; closed end <b>N</b></p>	<p><b>L N</b></p> <p><b>Mounting</b></p> <table border="1"> <tr> <td>No bracket</td> <td><b>A</b></td> </tr> <tr> <td>Port blocks</td> <td><b>C</b></td> </tr> <tr> <td>Port blocks &amp; wall brkt</td> <td><b>D</b></td> </tr> <tr> <td>Wall bracket</td> <td><b>W</b></td> </tr> </table> <p>* Regulator comes with gauge respective to the adjustment range selected. <sup>§</sup> Not available with poly bowl with bowl guard.</p>	No bracket	<b>A</b>	Port blocks	<b>C</b>	Port blocks & wall brkt	<b>D</b>	Wall bracket	<b>W</b>
F/R+L <b>A</b>	F+Fc+Fa <b>G</b>																																																																																
F+R+L <b>B</b>	F/R+Fc <b>M</b>																																																																																
F+Fc <b>F</b>																																																																																	
Poly bowl with bowl guard ‡	<b>G</b>																																																																																
Metal bowl without sight gauge	<b>M*</b>																																																																																
Metal bowl with sight gauge	<b>S</b>																																																																																
BSPP	<b>1</b>																																																																																
BSPT	<b>2</b>																																																																																
NPT	<b>9</b>																																																																																
1/4	<b>2*</b>																																																																																
3/8	<b>3</b>																																																																																
1/2	<b>4</b>																																																																																
0.01µ Element	<b>C</b>																																																																																
0.01µ Element with dpi	<b>D*</b>																																																																																
5µ Element	<b>E</b>																																																																																
5µ Element with dpi	<b>F*</b>																																																																																
1µ Element	<b>9</b>																																																																																
1µ Element with dpi	<b>Q*</b>																																																																																
Adsorber	<b>A</b>																																																																																
Auto drain	<b>A</b>																																																																																
Manual drain	<b>M</b>																																																																																
With round gauge																																																																																	
30 psig; 2 bar; 0.2 MPa	<b>Z</b>																																																																																
60 psig; 4 bar; 0.4 MPa	<b>M</b>																																																																																
125 psig; 8 bar; 0.8 MPa	<b>G</b>																																																																																
250 psig; 17 bar; 1.7 MPa	<b>J<sup>§</sup></b>																																																																																
Without gauge																																																																																	
30 psig; 2 bar; 0.2 MPa	<b>Y</b>																																																																																
60 psig; 4 bar; 0.4 MPa	<b>L</b>																																																																																
125 psig; 8 bar; 0.8 MPa	<b>N</b>																																																																																
250 psig; 17 bar; 1.7 MPa	<b>H<sup>§</sup></b>																																																																																
30* = 1	2* = V																																																																																
60 = 3	4 = S																																																																																
125 = 5	8 = T																																																																																
No bracket	<b>A</b>																																																																																
Port blocks	<b>C</b>																																																																																
Port blocks & wall brkt	<b>D</b>																																																																																
Wall bracket	<b>W</b>																																																																																



For inventory, lead time, and kit lookup, visit [www.pdnplu.com](http://www.pdnplu.com)

**Popular Combinations:** Inlet pressure 145 psig (10 bar), secondary pressure 91.3 psig (6.3 bar), 14.5 psig (1 bar) pressure drop.

**B**  
Global Air Preparation  
Introduction  
Filters  
Coalescers  
Regulators  
Filter / Regulators  
Lubricators  
Combinations  
Accessories and Kits



**Filter + Regulator + Lubricator Combinations, poly bowl**  
**5 micron element, 116 psig (8 bar) regulator + gauge and wall mounting brackets**

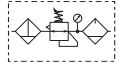

Port size	Flow	Manual drain	Auto drain
1/2"	90 scfm (43 dm <sup>3</sup> /s, ANR)	<b>P33CB94GEMNGLNW</b>	<b>P33CB94GEANGLNW</b>
3/4"	110 scfm (52 dm <sup>3</sup> /s, ANR)	<b>P33CB96GEMNGLNW</b>	<b>P33CB96GEANGLNW</b>



**Filter/Regulator + Lubricator Combinations, poly bowl**  
**5 micron element, 116 psig (8 bar) regulator + gauge and wall mounting brackets**

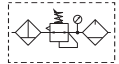

Port size	Flow	Manual drain	Auto drain
1/2"	110 scfm (52 dm <sup>3</sup> /s, ANR)	<b>P33CA94GEMNGLNW</b>	<b>P33CA94GEANGLNW</b>
3/4"	150 scfm (71 dm <sup>3</sup> /s, ANR)	<b>P33CA96GEMNGLNW</b>	<b>P33CA96GEANGLNW</b>



**Ball Valve + Filter + Regulator + Lubricator Combinations, poly bowl**  
**5 micron element, 116 psig (8 bar) regulator + gauge and wall mounting brackets**

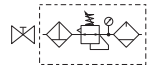

Port size	Flow	Manual drain	Auto drain
1/2"	90 scfm (43 dm <sup>3</sup> /s, ANR)	<b>P33QB94GEMNGLNW</b>	<b>P33QB94GEANGLNW</b>
3/4"	110 scfm (52 dm <sup>3</sup> /s, ANR)	<b>P33QB96GEMNGLNW</b>	<b>P33QB96GEANGLNW</b>



**Ball Valve + Filter/Regulator + Lubricator Combinations, poly bowl**  
**5 micron element, 116 psig (8 bar) regulator + gauge and wall mounting brackets**

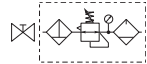

Port size	Flow	Manual drain	Auto drain
1/2"	110 scfm (52 dm <sup>3</sup> /s, ANR)	<b>P33QA94GEMNGLNW</b>	<b>P33QA94GEANGLNW</b>
3/4"	150 scfm (71 dm <sup>3</sup> /s, ANR)	<b>P33QA96GEMNGLNW</b>	<b>P33QA96GEANGLNW</b>

**Filter / Regulator coding**  
(use with codes: A M)

Filter coding (use with combo codes: B F G). For multiple filters, repeat as needed.	Regulator coding (use with combo code: B)	Lubricator coding (use with combo codes: A B)	Assembly configuration
-----------------------------------------------------------------------------------------	----------------------------------------------	--------------------------------------------------	------------------------

<p><b>P33</b></p> <p><b>Combination</b></p> <table border="1"> <tr><td>B/V + Combination</td><td><b>Q</b></td></tr> <tr><td>Combination + B/V</td><td><b>X</b></td></tr> <tr><td>Combination</td><td><b>C</b></td></tr> </table> <p>B/V = Ball valve</p> <p><b>Combination type*</b></p> <table border="1"> <tr><td>F/R+L</td><td><b>A</b></td><td>F+Fc+Fa</td><td><b>G</b></td></tr> <tr><td>F+R+L</td><td><b>B</b></td><td>F/R+Fc</td><td><b>M</b></td></tr> <tr><td>F+Fc</td><td><b>F</b></td><td></td><td></td></tr> </table> <p>* Combination type F = 5μ Fc = 1μ Fc = .01μ Fa = Adsorber</p> <p><b>Bowl type †</b></p> <table border="1"> <tr><td>Poly bowl with bowl guard</td><td><b>G</b></td></tr> <tr><td>Metal bowl without sight gauge</td><td><b>M*</b></td></tr> <tr><td>Metal bowl with sight gauge</td><td><b>S</b></td></tr> </table> <p>† For polycarbonate bowl, see caution in Engineering Section A.</p> <p>* Not available when using lubricator. <b>Note:</b> All bowl types are the same for each component. <b>Example:</b> If a "G" is specified for a F+L, both units would get a poly bowl with bowl guard.</p>	B/V + Combination	<b>Q</b>	Combination + B/V	<b>X</b>	Combination	<b>C</b>	F/R+L	<b>A</b>	F+Fc+Fa	<b>G</b>	F+R+L	<b>B</b>	F/R+Fc	<b>M</b>	F+Fc	<b>F</b>			Poly bowl with bowl guard	<b>G</b>	Metal bowl without sight gauge	<b>M*</b>	Metal bowl with sight gauge	<b>S</b>	<p><b>C B 9 6 G</b></p> <p><b>Thread type</b></p> <table border="1"> <tr><td>BSPP</td><td><b>1</b></td></tr> <tr><td>BSPT</td><td><b>2</b></td></tr> <tr><td>NPT</td><td><b>9</b></td></tr> </table> <p><b>Port size</b></p> <table border="1"> <tr><td>1/2</td><td><b>4</b></td></tr> <tr><td>3/4</td><td><b>6</b></td></tr> </table>	BSPP	<b>1</b>	BSPT	<b>2</b>	NPT	<b>9</b>	1/2	<b>4</b>	3/4	<b>6</b>	<p><b>E M</b></p> <p><b>Element</b></p> <table border="1"> <tr><td>0.01μ Element</td><td><b>C</b></td></tr> <tr><td>0.01μ Element with dpi</td><td><b>D*</b></td></tr> <tr><td>5μ Element</td><td><b>E</b></td></tr> <tr><td>5μ Element with dpi</td><td><b>F*</b></td></tr> <tr><td>1μ Element</td><td><b>9</b></td></tr> <tr><td>1μ Element with dpi</td><td><b>Q*</b></td></tr> <tr><td>Adsorber</td><td><b>A</b></td></tr> </table> <p>* Not available with F/R.</p> <p><b>Drain type</b></p> <table border="1"> <tr><td>Auto drain</td><td><b>A</b></td></tr> <tr><td>Manual drain</td><td><b>M</b></td></tr> </table>	0.01μ Element	<b>C</b>	0.01μ Element with dpi	<b>D*</b>	5μ Element	<b>E</b>	5μ Element with dpi	<b>F*</b>	1μ Element	<b>9</b>	1μ Element with dpi	<b>Q*</b>	Adsorber	<b>A</b>	Auto drain	<b>A</b>	Manual drain	<b>M</b>	<p><b>N G</b></p> <p><b>Relief / Adjustment</b></p> <table border="1"> <tr><td>Non-rising knob relieving</td><td><b>N</b></td></tr> </table> <p><b>Adjustment range</b></p> <table border="1"> <tr><td><b>With round gauge</b></td><td></td></tr> <tr><td>30 psig; 2 bar; 0.2 MPa</td><td><b>Z</b></td></tr> <tr><td>60 psig; 4 bar; 0.4 MPa</td><td><b>M</b></td></tr> <tr><td>125 psig; 8 bar; 0.8 MPa</td><td><b>G</b></td></tr> <tr><td>250 psig; 17 bar; 1.7 MPa</td><td><b>J*</b></td></tr> <tr><td><b>Without gauge</b></td><td></td></tr> <tr><td>30 psig; 2 bar; 0.2 MPa</td><td><b>Y</b></td></tr> <tr><td>60 psig; 4 bar; 0.4 MPa</td><td><b>L</b></td></tr> <tr><td>125 psig; 8 bar; 0.8 MPa</td><td><b>N</b></td></tr> <tr><td>250 psig; 17 bar; 1.7 MPa</td><td><b>H*</b></td></tr> </table> <p>* Not available with poly bowl with bowl guard.</p>	Non-rising knob relieving	<b>N</b>	<b>With round gauge</b>		30 psig; 2 bar; 0.2 MPa	<b>Z</b>	60 psig; 4 bar; 0.4 MPa	<b>M</b>	125 psig; 8 bar; 0.8 MPa	<b>G</b>	250 psig; 17 bar; 1.7 MPa	<b>J*</b>	<b>Without gauge</b>		30 psig; 2 bar; 0.2 MPa	<b>Y</b>	60 psig; 4 bar; 0.4 MPa	<b>L</b>	125 psig; 8 bar; 0.8 MPa	<b>N</b>	250 psig; 17 bar; 1.7 MPa	<b>H*</b>	<p><b>L N</b></p> <p><b>Lub type</b></p> <table border="1"> <tr><td>Oil mist standard sight dome</td><td><b>L</b></td></tr> </table> <p><b>Drain type</b></p> <table border="1"> <tr><td>No drain; closed end</td><td><b>N</b></td></tr> </table>	Oil mist standard sight dome	<b>L</b>	No drain; closed end	<b>N</b>	<p><b>W</b></p> <p><b>Mounting</b></p> <table border="1"> <tr><td>No bracket</td><td><b>A</b></td></tr> <tr><td>Port blocks</td><td><b>C</b></td></tr> <tr><td>Port blocks &amp; wall brkt</td><td><b>D</b></td></tr> <tr><td>Wall bracket</td><td><b>W</b></td></tr> </table>	No bracket	<b>A</b>	Port blocks	<b>C</b>	Port blocks & wall brkt	<b>D</b>	Wall bracket	<b>W</b>
B/V + Combination	<b>Q</b>																																																																																										
Combination + B/V	<b>X</b>																																																																																										
Combination	<b>C</b>																																																																																										
F/R+L	<b>A</b>	F+Fc+Fa	<b>G</b>																																																																																								
F+R+L	<b>B</b>	F/R+Fc	<b>M</b>																																																																																								
F+Fc	<b>F</b>																																																																																										
Poly bowl with bowl guard	<b>G</b>																																																																																										
Metal bowl without sight gauge	<b>M*</b>																																																																																										
Metal bowl with sight gauge	<b>S</b>																																																																																										
BSPP	<b>1</b>																																																																																										
BSPT	<b>2</b>																																																																																										
NPT	<b>9</b>																																																																																										
1/2	<b>4</b>																																																																																										
3/4	<b>6</b>																																																																																										
0.01μ Element	<b>C</b>																																																																																										
0.01μ Element with dpi	<b>D*</b>																																																																																										
5μ Element	<b>E</b>																																																																																										
5μ Element with dpi	<b>F*</b>																																																																																										
1μ Element	<b>9</b>																																																																																										
1μ Element with dpi	<b>Q*</b>																																																																																										
Adsorber	<b>A</b>																																																																																										
Auto drain	<b>A</b>																																																																																										
Manual drain	<b>M</b>																																																																																										
Non-rising knob relieving	<b>N</b>																																																																																										
<b>With round gauge</b>																																																																																											
30 psig; 2 bar; 0.2 MPa	<b>Z</b>																																																																																										
60 psig; 4 bar; 0.4 MPa	<b>M</b>																																																																																										
125 psig; 8 bar; 0.8 MPa	<b>G</b>																																																																																										
250 psig; 17 bar; 1.7 MPa	<b>J*</b>																																																																																										
<b>Without gauge</b>																																																																																											
30 psig; 2 bar; 0.2 MPa	<b>Y</b>																																																																																										
60 psig; 4 bar; 0.4 MPa	<b>L</b>																																																																																										
125 psig; 8 bar; 0.8 MPa	<b>N</b>																																																																																										
250 psig; 17 bar; 1.7 MPa	<b>H*</b>																																																																																										
Oil mist standard sight dome	<b>L</b>																																																																																										
No drain; closed end	<b>N</b>																																																																																										
No bracket	<b>A</b>																																																																																										
Port blocks	<b>C</b>																																																																																										
Port blocks & wall brkt	<b>D</b>																																																																																										
Wall bracket	<b>W</b>																																																																																										



For inventory, lead times, and kit lookup, visit [www.pdnplu.com](http://www.pdnplu.com)

**Popular Combination Dimensions**

inches (mm)

**P31C**

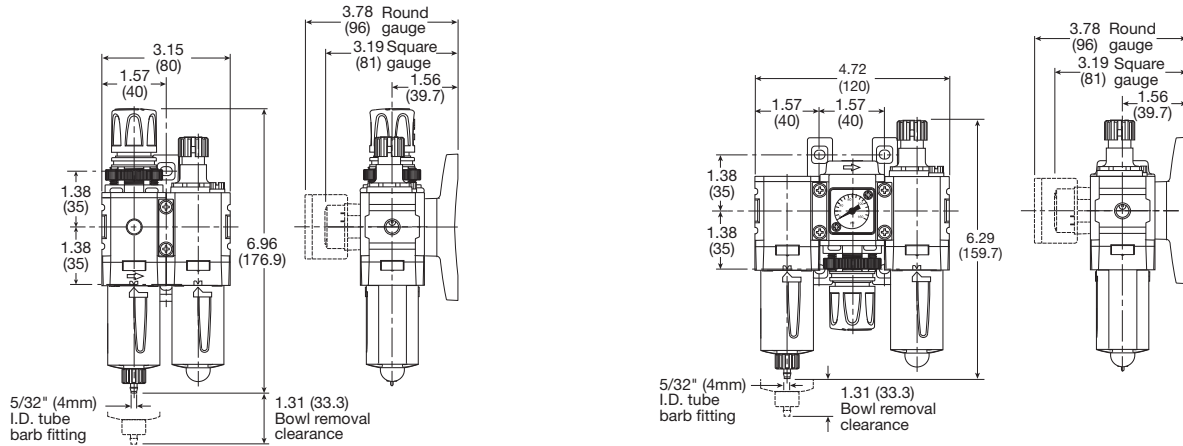

**P32C**

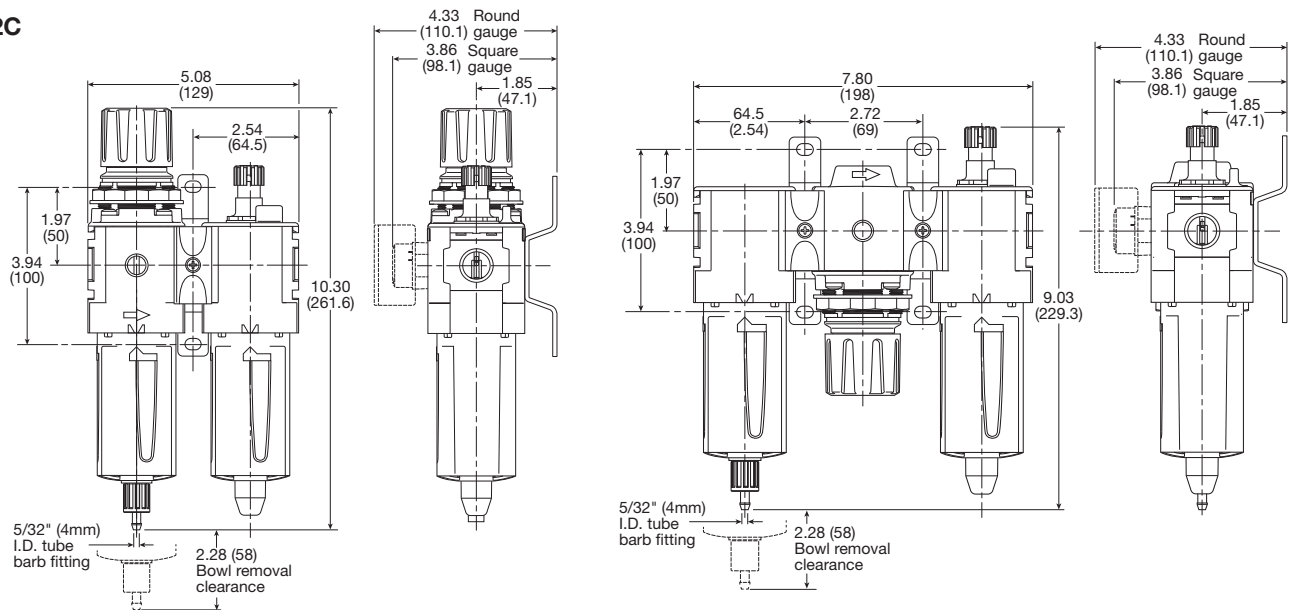

**P33C**

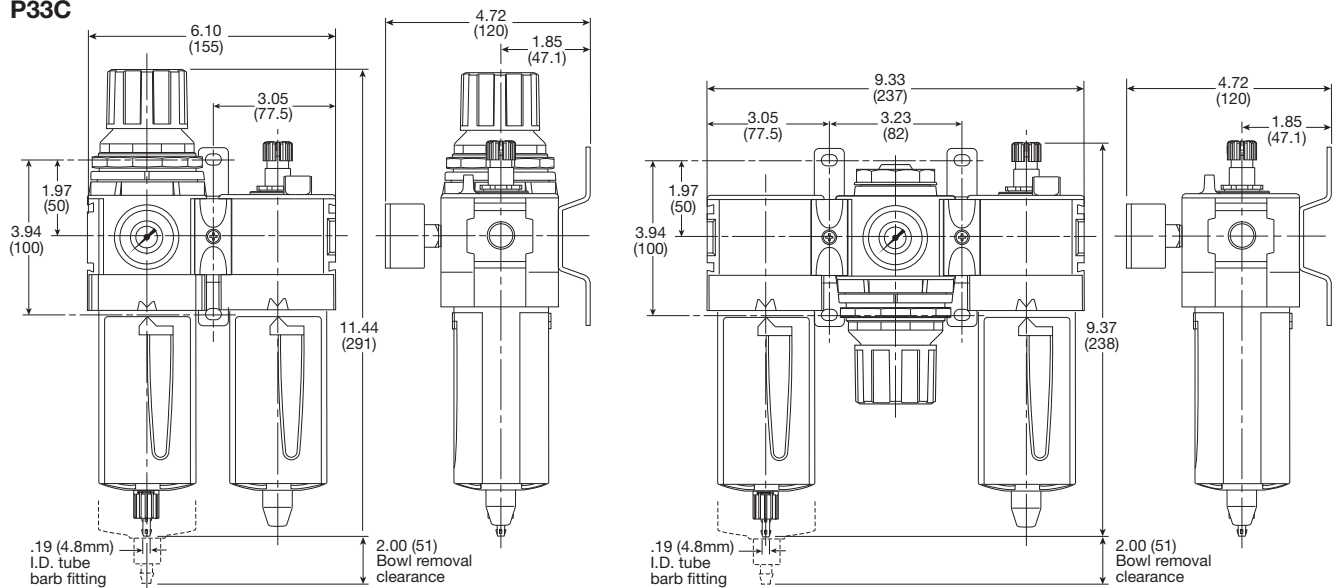

<b>B</b>
Global Air Preparation
Introduction
Filters
Coalescers
Regulators
Filter/Regulators
Lubricators
Combinations
Accessories and Kits



For inventory, lead time, and kit lookup, visit [www.pdnplu.com](http://www.pdnplu.com)

## P31D & P32D Dump Valves

- Modular design with 1/4" or 1/2" integral ports (NPT, BSPP & BSPT)
- The 3-way, 2-position function automatically dumps downstream pressure on the loss of pilot signal
- Solenoid or air pilot options
- High flow & exhaust capability
- Silencer included

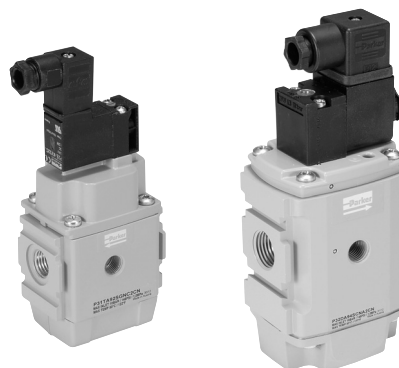
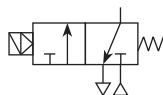

Remotely operated dump valves automatically shut off upstream pressure and exhaust the downstream pressure when the pilot pressure is released.

To maintain these units in the open position a pilot supply to the air pilot operated version or an electrical signal to the solenoid operated version must be maintained.

The valve will automatically dump when the holding signal is removed.

Port size	Description	Weight lbs (kg)	Part number
1/4"	120VAC Solenoid & cable plug	0.8 (0.37)	<b>P31DA92SGNC1FN</b>
1/4"	24VDC Solenoid & cable plug †	0.9 (0.41)	<b>P31DA92SGNC2CN</b>
1/4"	External air pilot operated	0.8 (0.37)	<b>P31DA92PPN</b>
1/2"	120VAC 30mm coil & cable plug incl. †	1.5 (0.69)	<b>P32DA94SCNA3GN</b>
1/2"	24VDC 30mm coil & cable plug incl. †	2.0 (0.91)	<b>P32DA94SCNA2CN</b>
1/2"	External air pilot operated †	1.9 (0.87)	<b>P32DA94PPN</b>

† Includes exhaust silencer

### Operating information

Flow capacity*:	P31D	36 scfm (17 dm <sup>3</sup> /s, ANR)
	P32D	108 scfm (51 dm <sup>3</sup> /s, ANR)
Temperature range (max)†:	Solenoid operated	14°F to 122°F (-10°C to 50°C)
	Air pilot operated	-4°F to 176°F (-20°C to 80°C)
	Pressure (max):	
	Solenoid operated	150 psig (10 bar)
	Air pilot operated	250 psig (17 bar)
Operating pressure (min):	44 psig (3 bar)	
Fluid:	Compressed air	
Ports:	Air pilot	1/8
	Exhaust	P31D - 1/4; P32D - 1/2
	Gauge	P31D - 1/8; P32D - 1/4

\* Inlet pressure 91.3 psig (6.3 bar), inlet pressure and 14.5 psig (1 bar) pressure drop.

† Air supply must be dry enough to avoid ice formation at temperatures below 35.6°F (2°C). Snap pressure: Full flow when downstream pressure reaches 50% of the inlet pressure.

### Ordering Information:

P31DA
9
2
S
G
N

**Body size**

Dump valve (1/4")	P31DA
Dump valve (1/2")	P32DA

**Thread type**

BSPP	1
BSPT	2
NPT	9

**Port size**

Global modular mini (1/4")	2
Global modular compact (1/2")	4

**Actuator interface**

G	15mm solenoid (P31 only)
C	30mm solenoid
P	Threaded air pilot

**Pilot type**

P	External air pilot
S	Solenoid pilot

**Solenoid voltage**

2CN	24VDC non locking manual override
3GN	120VAC non locking manual override
1FN	120VAC non locking manual override (P31 series only)

**Solenoid type**

C	15mm (P31 series only)
A	30mm CNOMO coil (P32 only)
D	30mm CNOMO coil (M12 connection) (P32 only)

Note: P32 unit used for both P32 & P33 series

Most popular.



For inventory, lead times, and kit lookup, visit [www.pdnplu.com](http://www.pdnplu.com)

# Dump Valves

## Material Specifications

Body	Aluminum
Body cover	Polyester
Seals	Nitrile NBR

## Mounting Brackets

	Description	Part number
P31	L-bracket mounting kit	P3HKA00ML
P31	Foot bracket mounting kit	P3HKA00MC

**Note:**

For solenoid operators and cable plugs (connectors) see page B79 and B80.

# Air Preparation Products

## Global Air Preparation

## Flow Charts

**P31DA 1/4" Remote Dump Valve**

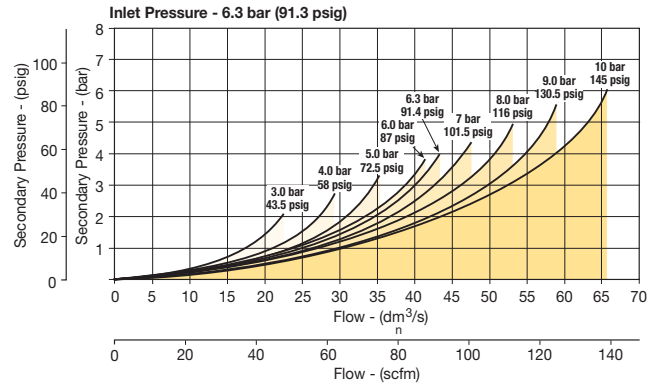

**P32DA 1/2" Remote Dump Valve**

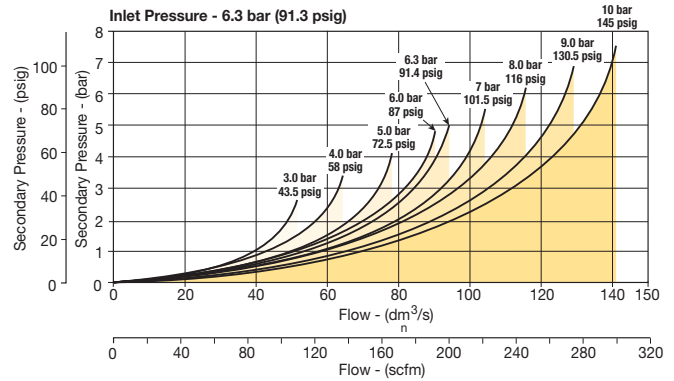

## Dimensions inches (mm)

**P31D**

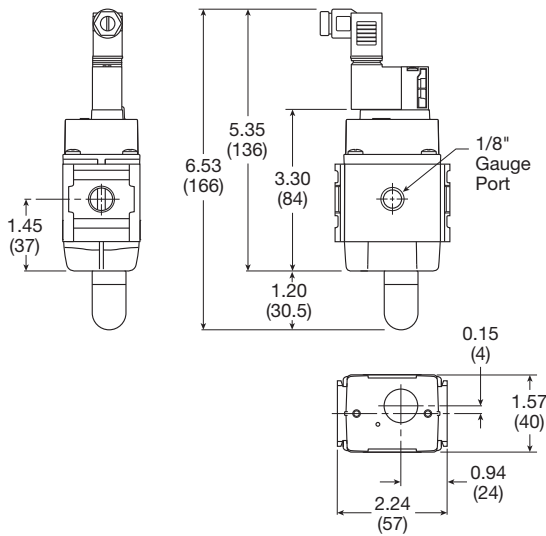

**P32D**

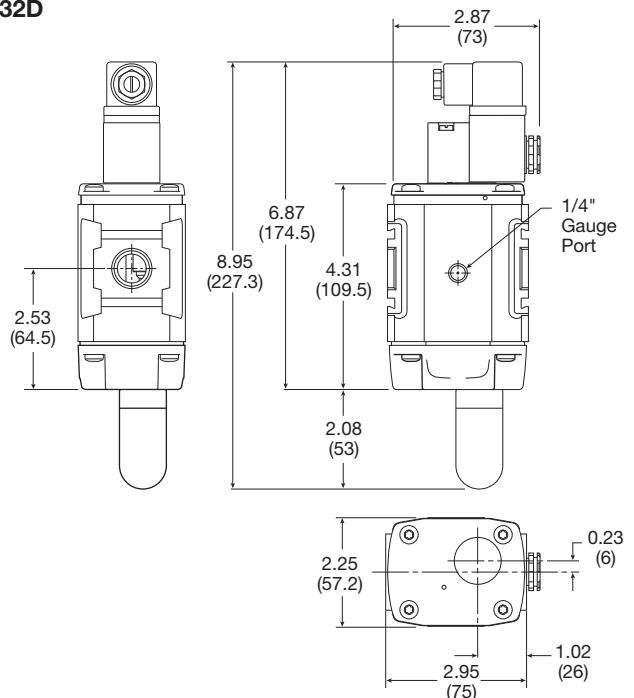

Most popular.



For inventory, lead time, and kit lookup, visit [www.pdnplu.com](http://www.pdnplu.com)

## P31S & P32S Soft Start Valves

- Modular design with 1/4" or 1/2" integral ports (NPT, BSPP & BSPT)
- The 2-way, 2-position function provides for the safe introduction of pressure
- Adjustable slow start
- Solenoid or air pilot options
- High flow

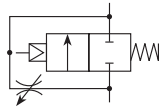

Parker Global Series Soft Start Valves, provide for the safe introduction of pressure to machines or systems. Soft Start Valves, allow the pressure to gradually build to the set point before fully opening to deliver full flow at line pressure.

The controlled introduction of pressure can be an important safety factor and prevent damage to tooling when air pressure is introduced at machine or system start up.

**Note:** Soft Start Valves must be installed downstream of a 3/2 valve with exhaust capability

Port size	Description	Weight lbs (kg)	Part number
1/4"	120VAC Solenoid & cable plug	0.8 (0.37)	<b>P31SA92SGNC1FN</b>
1/4"	24VDC Solenoid & cable plug	0.9 (0.41)	<b>P31SA92SGNC2CN</b>
1/4"	Internal air pilot operated	0.8 (0.37)	<b>P31SA92Y0N</b>
1/4"	External air pilot (1/8" threaded)	0.8 (0.37)	<b>P31SA92PPN</b>
1/2"	120VAC 30mm coil & cable plug incl.	1.5 (0.87)	<b>P32SA94SCNA3GN</b>
1/2"	24VDC 30mm coil & cable plug	2.0 (0.90)	<b>P32SA94SCNA2CN</b>
1/2"	Internal air pilot operated	2.0 (0.90)	<b>P32SA94Y0N</b>
1/2"	External air pilot (1/8 threaded)	1.5 (0.87)	<b>P32SA94PPN</b>

### Operating information

Flow capacity*:	P31S	36 scfm (17 dm <sup>3</sup> /s, ANR)
	P32S	101 scfm (48 dm <sup>3</sup> /s, ANR)
Temperature range (max)†:		
Solenoid operated		14°F to 122°F (-10°C to 50°C)
Air pilot operated		-4°F to 176°F (-20°C to 80°C)
Pressure (max):		
Solenoid operated		150 psig (10 bar)
Air pilot operated		250 psig (7 bar)
Operating pressure (min):		44 psig (3 bar)
Fluid:		Compressed air
Ports:	Air pilot	1/8
	Gauge	P31S - 1/8; P32S - 1/4

\* Inlet pressure 91.3 psig (6.3 bar), inlet pressure and 14.5 psig (1 bar) pressure drop.

† Air supply must be dry enough to avoid ice formation at temperatures below 35.6°F (2°C). Snap pressure: Full flow when downstream pressure reaches 50% of the inlet pressure.

### Ordering Information:

P31SA 9 2 S G N

**Body size**

Soft start	P31SA
Soft start	P32SA

**Thread type**

BSPP	1
BSPT	2
NPT	9

**Port size**

Global modular mini (1/4")	2
Global modular compact (1/2")	4

**Actuator interface**

O	Internal pilot
G	15mm solenoid (P31 only)
C	30mm solenoid
P	Threaded air pilot

**Pilot type**

P	External air pilot
S	Solenoid pilot
Y	Internal air pilot

**Solenoid type only**

C	2CN
---	-----

**Solenoid voltage**

2CN	24VDC non locking manual override
3GN	120VAC non locking manual override
1FN	120VAC non locking manual override (P31 series only)

**Solenoid type**

C	15mm (P31 series only)
A	30mm CNOMO coil (P32 only)
D	30mm CNOMO coil (M12 connection) (P32 only)

**Note:** P32 unit used for both P32 & P33 series

Most popular.





For inventory, lead times, and kit lookup, visit [www.pdnplu.com](http://www.pdnplu.com)

**Material Specifications**

Body	Aluminum
Body cover	Polyester
Seals	Nitrile NBR

**Mounting Brackets**

	Description	Part number
		<b>P31S</b>
	L-bracket mounting kit	<b>P3HKA00ML</b>
	Foot bracket mounting kit	<b>P3HKA00MC</b>

**Note:**

For solenoid operators and cable plugs (connectors) see page B79 and B80.

**Flow Charts**

**P31SA 1/4" Soft Start Valve**

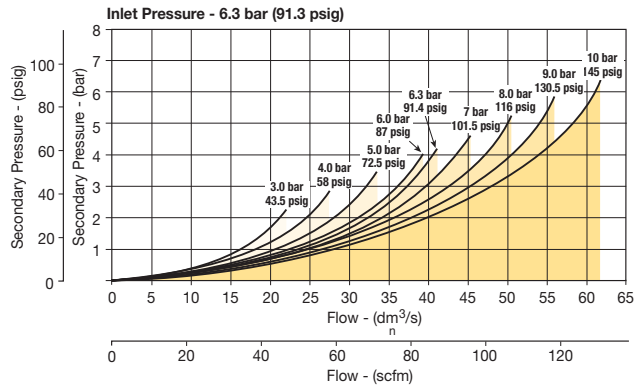

**P32SA 1/2" Soft Start Valve**

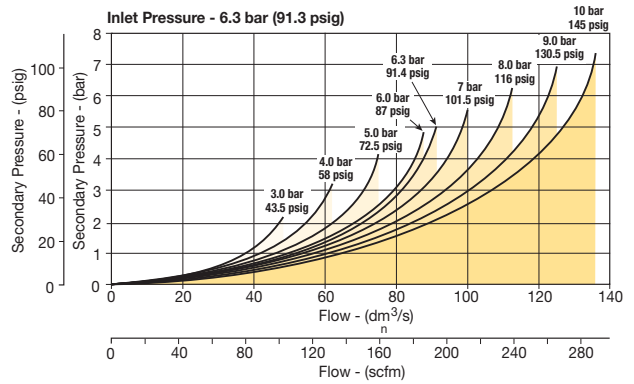

**Dimensions inches (mm)**

**P31S**

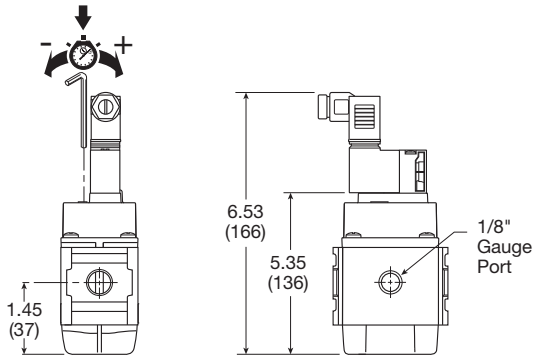

**P32S**

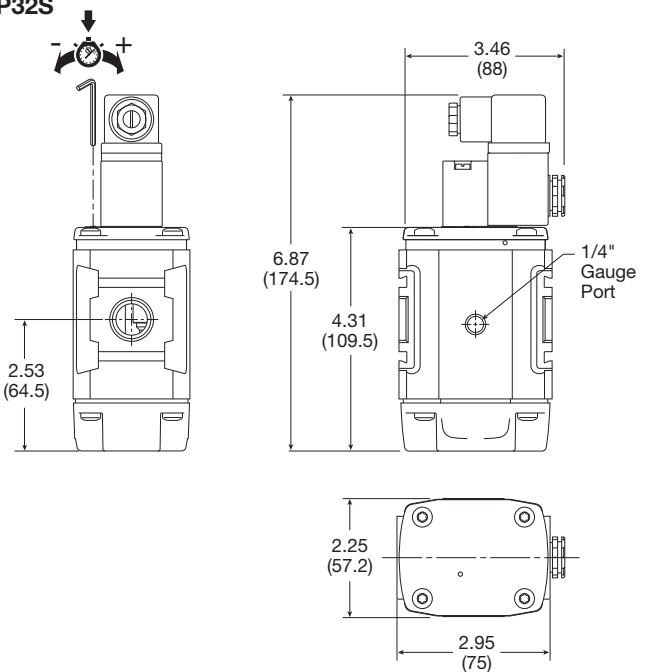

**Soft Start Function:**

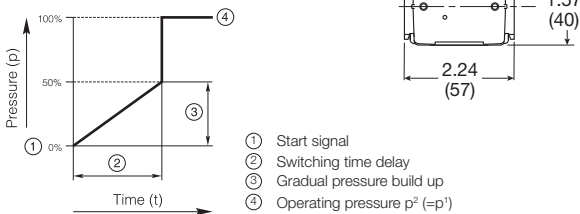

For inventory, lead time, and kit lookup, visit [www.pdnplu.com](http://www.pdnplu.com)

**P31T & P32T Combined Soft Start / Dump Valves**

- Modular design with 1/4" or 1/2" integral ports (NPT, BSPP & BSPT)
- Provides for the safe introduction of pressure
- The 3-way, 2-position function automatically dumps downstream pressure on the loss of pilot signal
- Adjustable slow start
- Solenoid or air pilot options
- High flow & exhaust capability
- Silencer included

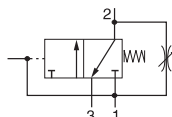

Parker Global Series Combined Soft Start / Dump Valves, provide for the safe introduction of pressure to machines or systems. Soft Start / Dump Valves when set, allow the pressure to gradually build to the set point before fully opening to deliver full flow at line pressure.

The controlled introduction of pressure can be an important safety factor and prevent damage to tooling when air pressure is introduced at machine or system start up.

To maintain these units in the open position a pilot supply to the air pilot operated version or an electrical signal to the solenoid operated version must be maintained. The valve will automatically dump when the holding signal is removed.

Port size	Description	Weight lbs (kg)	Part number
1/4"	120VAC Solenoid & cable plug	0.8 (0.37)	<b>P31TA92SGNC1FN</b>
1/4"	24VDC Solenoid & cable plug	0.9 (0.41)	<b>P31TA92SGNC2CN</b>
1/4"	External air pilot operated	0.8 (0.37)	<b>P31TA92PPN</b>
1/2"	120VAC 30mm coil & cable plug incl.	1.9 (0.87)	<b>P32TA94SCNA3GN</b>
1/2"	24VDC 30mm coil & cable plug incl.	2.0 (0.91)	<b>P32TA94SCNA2CN</b>
1/2"	External air pilot operated	1.9 (0.87)	<b>P32TA94PPN</b>

**Operating information**

Flow capacity*:	P31T	36 scfm (17 dm <sup>3</sup> /s, ANR)
	P32T	108 scfm (51 dm <sup>3</sup> /s, ANR)
Temperature range (max)†:		
	Solenoid operated	14°F to 122°F (-10°C to 50°C)
	Air pilot operated	-4°F to 176°F (-20°C to 80°C)
Pressure (max):		
	Solenoid operated	150 psig (10 bar)
	Air pilot operated	250 psig (7 bar)
Operating pressure (min):		44 psig (3 bar)
Fluid:		Compressed air
Ports:	Air pilot	1/8
	Exhaust	P31T - 1/4; P32T - 1/2
	Gauge	P31T - 1/8; P32T - 1/4

\* Inlet pressure 91.3 psig (6.3 bar), inlet pressure and 14.5 psig (1 bar) pressure drop.

† Air supply must be dry enough to avoid ice formation at temperatures below 35.6°F (2°C). Snap pressure: Full flow when downstream pressure reaches 50% of the inlet pressure.

**Ordering Information:**

**P31TA 9 2 S G N C 2CN**

Body size	Thread type	Pilot type	Actuator interface	Solenoid type	Solenoid voltage
Soft start / dump valve (1/4") P31TA	BSPP 1	P External air pilot	G 15mm solenoid (P31 only)	C 15mm (P31 series only)	2CN 24VDC non locking manual override
Soft start / dump valve (1/2") P32TA	BSPT 2	S Solenoid pilot	C 30mm solenoid	A 30mm CNOMO coil (P32 only)	3GN 120VAC non locking manual override
	NPT 9		P Threaded air pilot	D 30mm CNOMO coil (M12 connection) (P32 only)	1FN 120VAC non locking manual override (P31 series only)

**Note:** P32 unit used for both P32 & P33 series

Port size:  
Global modular mini (1/4") 2  
Global modular compact (1/2") 4

□ Most popular.

**B**  
Global Air  
Preparation

Introduction

Filters

Coalescers

Regulators

Filter /  
Regulators

Lubricators

Combinations

Accessories  
and Kits



For inventory, lead times, and kit lookup, visit [www.pdnplu.com](http://www.pdnplu.com)



# Combined Soft Start / Dump Valves

## Material Specifications

Body	Aluminum
Body cover	Polyester
Seals	Nitrile NBR

## Mounting Brackets

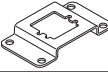
	Description	Part number
		P31T
	L-bracket mounting kit	P3HKA00ML
	Foot bracket mounting kit	P3HKA00MC

**Note:**

For solenoid operators and cable plugs (connectors) see page B79 and B80.

# Air Preparation Products

## Global Air Preparation

## Flow Charts

### P31TA 1/4" Soft Start & Dump Valve

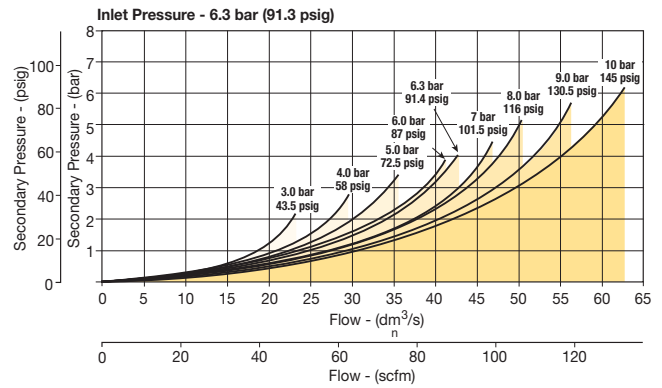

### P32TA 1/2" Soft Start & Dump Valve

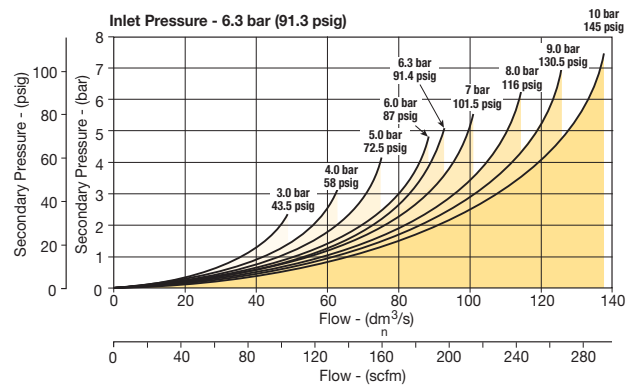

## Dimensions inches (mm)

### P31T

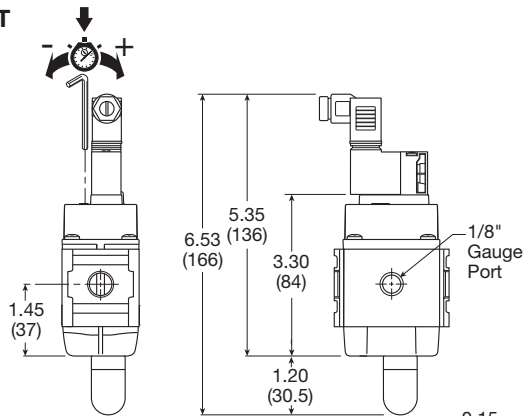

### P32T

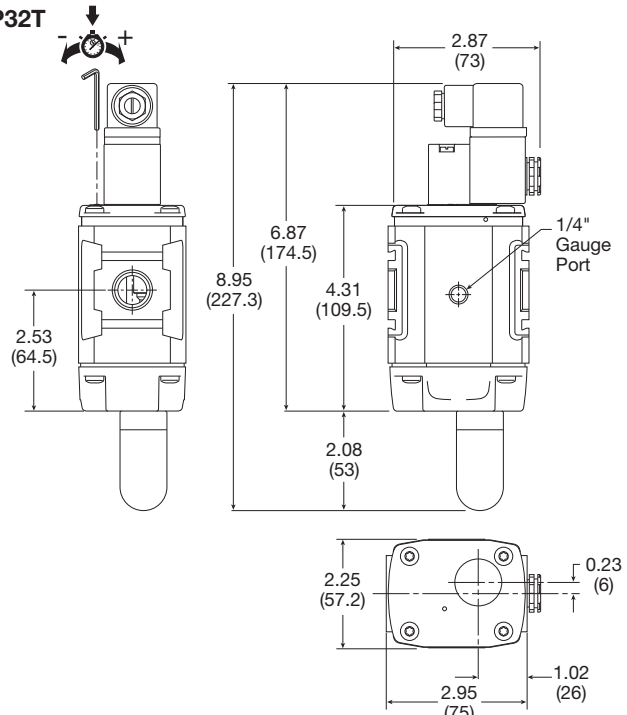

## Soft Start Function:

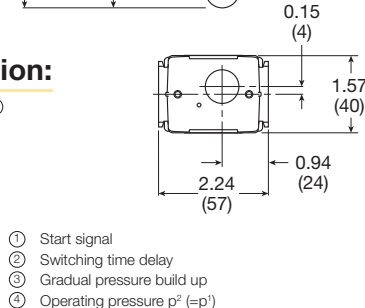
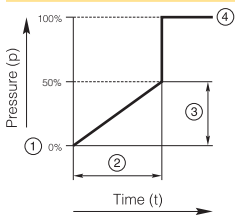

- Start signal
- Switching time delay
- Gradual pressure build up
- Operating pressure p<sub>2</sub> (=p<sub>1</sub>)

**B**

Global Air Preparation

Introduction

Filters

Coalescers

Regulators

Filter/Regulators

Lubricators

Combinations

Accessories and Kits



For inventory, lead time, and kit lookup, visit [www.pdnplu.com](http://www.pdnplu.com)

## P33T Redundant Safety Exhaust Valve

- Proven control reliable technology with integrated soft start
- Soft start application of air to the system when energized; can be adjusted for slower or faster buildup of system pressure
- Rapid exhaust of downstream air when de-energized to remove stored energy and allow safe access
- Memory, monitoring, and air flow control functions are integrated into two identical valve elements. Valves lock-out if asynchronous movement of valve elements occurs during actuation or de-actuation, resulting in a residual outlet pressure of less than 1% of supply.
- Reset can only be accomplished by the integrated electrical (solenoid) reset. Cannot be reset by removing and re-applying supply pressure.
- Basic 3/2 normally closed valve function: Dirt tolerant, wear compensating poppet design for quick response and high flow capacity.
- LED indicators of main solenoid operation, reset solenoid operation, and status indicator condition.
- Optional transducer for monitoring of downstream pressure in the system.
- Dual exhaust silencers included.
- Not for use with clutch / brake applications.
- For use in conjunction with a safety relay or safety PLC.



### Operating information

Pilot Solenoids:	According to VDE 0580
Enclosure rating:	According to DIN 400 50 IP65
Connector socket:	According to DIN 43650 Form A Three solenoids, rated for continuous duty
Standard voltages:	24VDC
Power consumption (each solenoid), for primary & reset solenoids:	1.2 Watts on DC
Enclosure rating:	IP65, IEC 60529
Electrical connection:	M12, 5-pin
Ambient temperature:	15°F to 122°F (-10°C to 50°C)
Media temperature:	40°F to 175°F (4°C to 80°C)
Flow media:	Compressed Air, Filtered to Minimum 40 Micron
Inlet pressure:	30 to 150 psig (2 to 10 bar)
Monitoring:	Dynamically, cyclically, internally during each actuating and de-actuating movement. Monitoring function has memory and requires an overt act to reset unit after lockout.
Mounting orientation:	Vertically with pilot solenoids on top
Port threads:	3/4 NPT, 3/4 BSPP
Control reliable:	Category 4 (Cat 4); performance Level e (PLe) in accordance with Machine directive - EN ISO 13849-1 (Certification pending)
Weight:	16.1 lb (7.3 kg) w/o transducer 16.3 lb (7.4 kg) w/ transducer

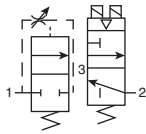

Port size			Cv		Part number*
Inlet	Outlet	Transducer	1 to 2	2 to 3	
3/4	3/4	w/o transducer	3.7	8.5	<b>P33TA96RG4F2CN</b>
3/4	3/4	w/ transducer	3.7	8.5	<b>P33TA96RG4G2CN</b>

\* NPT port threads. For BSPP threads, replace "9" in the part number with a "1".

### Ordering Information:

<b>P33TA</b>	<b>9</b>	<b>6 R</b>	<b>G 4</b>	<b>F</b>	<b>2CN</b>
<b>Body size</b> Standard P33T	<b>Port size</b> 3/4" 6	<b>Operator</b> 15mm Solenoid G	<b>Solenoid</b> Dual M12 connector without transducer F Triple M12 connector with transducer G	<b>Voltage</b> 24VDC with manual override 2CN	
<b>Thread type</b> BSPP 1 NPT 9	<b>Type</b> Solenoid pilot + gauge R	<b>Mounting</b> Cat 4 w/bracket 4			

Most popular.



For inventory, lead times, and kit lookup, visit [www.pdnplu.com](http://www.pdnplu.com)

**B**  
 Global Air Preparation  
 Introduction  
 Filters  
 Coalescers  
 Regulators  
 Filter / Regulators  
 Lubricators  
 Combinations  
 Accessories and Kits

**Repair and Service Kits**

Black grill	<b>1834C05-001</b>
Body connector	<b>P32KA00CB</b>
M12, 5-pin female to flying lead cable, TPE; 6.6 ft (2 m)	<b>RKC 4.5T-2/S1587</b>
M12, 5-pin male to flying lead cable, TPE; 6.6 ft (2 m)	<b>RSC 4.5T-2/S1587</b>
1/2 NPT, port block kit	<b>P32KA94CP</b>
3/4 NPT, port block kit	<b>P32KA96CP</b>
1/2 BSPP, port block kit	<b>P32KA14CP</b>
3/4 BSPP, port block kit	<b>P32KA16CP</b>
1/2 BSPT, port block kit	<b>P32KA24CP</b>
3/4 BSPT, port block kit	<b>P32KA26CP</b>
Pressure switch	<b>1227A30-001</b>
Pressure transducer (optional)	<b>1232H30-001</b>
T-bracket w/ body connector	<b>P32KA00MT</b>
T-bracket (fits to body connector or port block)	<b>P32KA00MB</b>
Silencer(s) 3/4"	<b>5500A5013</b>
Solenoid (main & reset)	<b>1527B7916-001</b>
Square flush mounting gauge kit, 0-160 psig	<b>K4511SCR160</b>

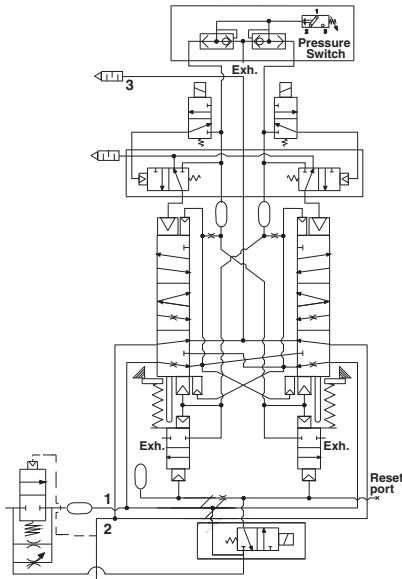

**Valve Wiring**

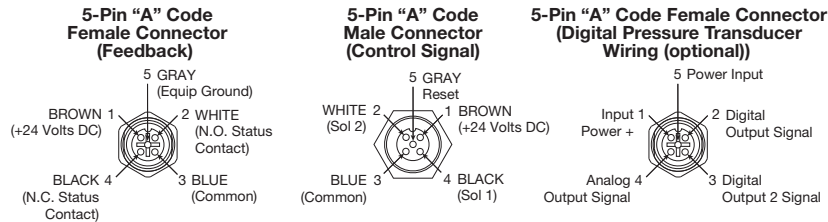

**Dimensions inches (mm)**

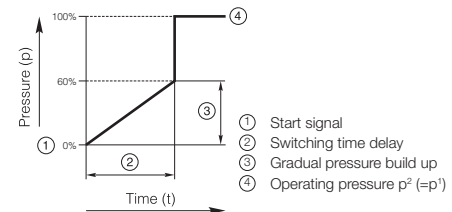
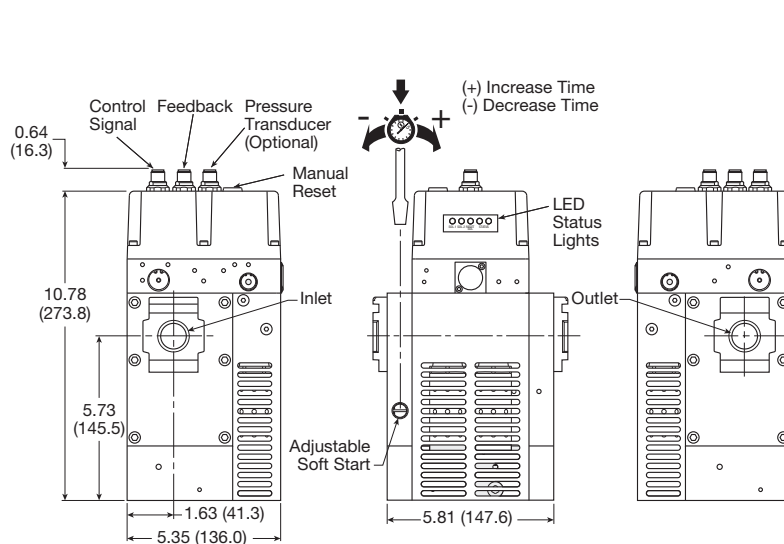

**Angle Mounting Bracket**

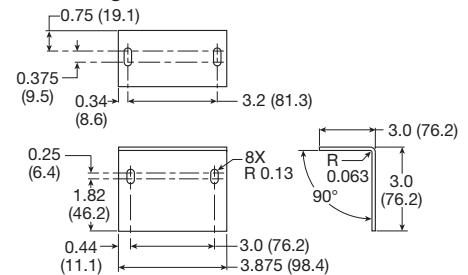

**Note:** Mounting bracket and installation screws included and required to install unit in the system.



For inventory, lead time, and kit lookup, visit [www.pdnplu.com](http://www.pdnplu.com)

B67

**Parker Hannifin Corporation**  
 Pneumatic Division  
 Richland, Michigan  
[www.parker.com/pneumatics](http://www.parker.com/pneumatics)

**B**

Global Air Preparation

Introduction

Filters

Coalescers

Regulators

Filter/Regulators

Lubricators

Combinations

Accessories and Kits

**Valve de-actuated (ready-to-run):**

The flow of inlet air pressure to the inlet chamber of the main valve internals is restricted by a fixed orifice and an adjustable flow control as well as an air piloted 2-way normally closed poppet valve. The flow of inlet air pressure into the crossover passages is restricted by the size of the passage between the stem and the valve body opening. Flow is sufficient to quickly pressurize pilot supply / timing chambers 1 and 2. The inlet poppets prevent air flow from crossover passages into the outlet chamber. Air pressure acting on the inlet poppets and return pistons securely hold the valve elements in the closed position. (Reset adapter omitted for clarity.)

The green "Status" LED will be illuminated indicating the valve is operational.

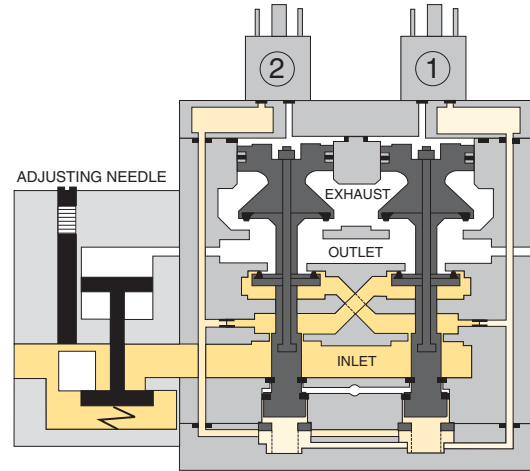
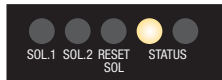

**Valve actuated:**

Energizing the pilot valves simultaneously applies pressure to both pistons, forcing the internal parts to move to their actuated (open) position, where inlet air flow to crossover passages is fully open, inlet poppets are fully open and exhaust poppets are fully closed. The outlet is then pressurized at a rate allowed by the fixed orifice and the adjusted flow control. Once the air pressure in the outlet chamber reaches approximately 60% of inlet pressure, the air piloted 2-way normally closed poppet valve opens fully and the pressure in the inlet, crossovers, outlet, and timing chambers are quickly equalized. The adjustable flow control will control the time it takes for the outlet air pressure to reach approximately 60% of inlet pressure.

De-energizing the pilots quickly causes the valve elements to return to the ready-to-run position.

Solenoid 1, Solenoid 2 and the green "Status" LED's will be illuminated indicating the valve is operating properly.

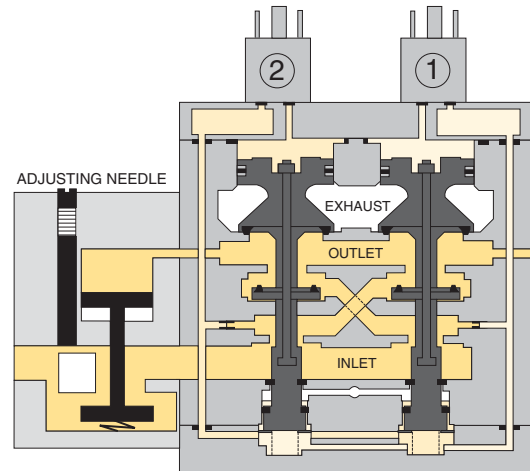
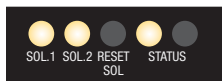

**Soft start function:**

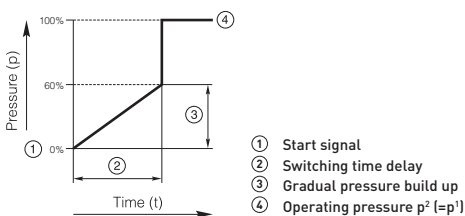

**Global Air Preparation**

Introduction

Filters

Coalescers

Regulators

Filter / Regulators

Lubricators

Combinations

Accessories and Kits



For inventory, lead times, and kit lookup, visit [www.pdnplu.com](http://www.pdnplu.com)

**Valve fault and lock-out:**

Whenever the valve elements operate in a sufficiently asynchronous manner, either on actuation or de-actuation, the valve will move to a locked-out position. In the locked-out position, one crossover and its related timing chamber will be exhausted, and the other crossover and its related timing chamber will be fully pressurized. The valve element (side 2) that is partially actuated has pilot air available to fully actuate it, but no air pressure on the return piston to fully de-actuate the valve element.

Air pressure in the crossover acts on the differential of side 2 stem diameters creating a latching force. Side 1 is in a fully closed position, and has no pilot air available to actuate, but has full pressure on the inlet poppet and return piston to hold the element in the fully closed position. Inlet air flow on side 1 into its crossover is restricted, and flows through the open inlet poppet on side 2, through the outlet into the exhaust port, and from the exhaust port to atmosphere. Residual pressure in the outlet is less than 1% of inlet pressure. The return springs are limited in travel, and can only return the valve elements to the intermediate (locked-out) position. Sufficient air pressure acting on the return pistons is needed to return the valve elements to a fully closed position.

The red "Status" LED will be illuminated indicating the valve in fault and lock-out must be reset

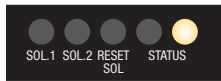

**Valve reset (electrical or manual):**

The reset procedure is as follows:

- Remove the electrical signals to the main coils
- Ensure there is air supplied to the valve
- Energize the reset solenoid for a minimum of 200 ms
- Allow a 200 ms delay after de-energizing the reset solenoid and re-energizing the main solenoids

The valve will remain in the locked-out position, even if the inlet air supply is removed and re-applied.

A remote reset signal must be applied to reset the valve. A momentary, remote electrical signal must be applied to the reset solenoid to apply pressure to the reset pistons in the valve. Actuation of the reset piston physically pushes the main valve elements to their closed position. Inlet air fully pressurizes the crossovers and holds the inlet poppets on seat. Actuation of the reset piston opens the reset poppet, thereby, immediately exhausting pilot supply air, thus, preventing valve operation during reset (Reset adapter added to illustration.). De-actuation of reset pistons causes the reset poppets to close and pilot supply to fully pressurize. Reset air pressure is applied by a 3/2 normally closed solenoid, or a manual push button mounted on the reset adapter in the top valve cover.

The green "Status" LED will be illuminated once the valve is reset.

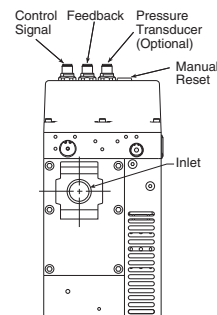
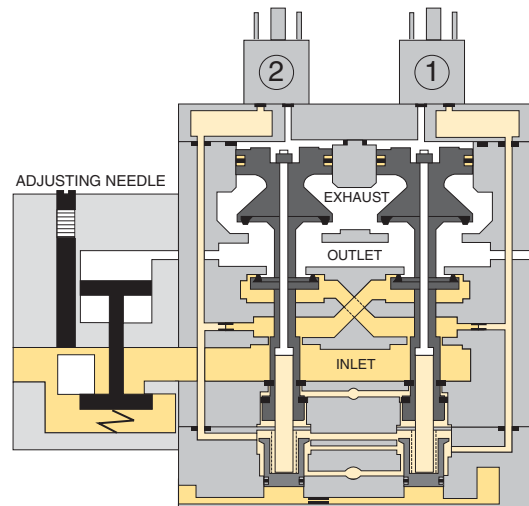
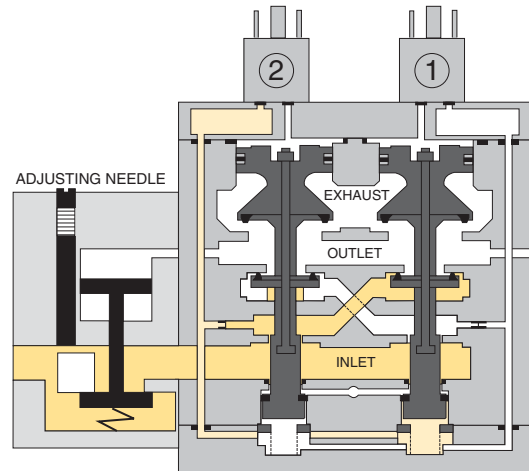
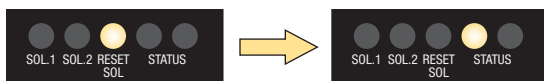

B	Global Air Preparation
Introduction	Filters
Coalescers	Regulators
Filter/Regulators	Lubricators
Combinations	Accessories and Kits



For inventory, lead time, and kit lookup, visit [www.pdnplu.com](http://www.pdnplu.com)

## Ball Valve / Lockout Valve

The Ball / Lockout Valve shuts off downstream line pressure in the closed position with a 90° turn of the handle. In the closed position, inlet air pressure is blocked and downstream / system air is exhausted through a threaded port. To prevent unauthorized adjustment, the padlock slide may be assembled on either side. It is recommended that this slide is installed after final system assembly.

The Safety Lockout valves conform to OSHA #29 CFR part 1910 — control of hazardous energy source (lockout / tagout).

**Note:** This padlock slide is a permanent assembly and may not be removed later, any unauthorized tampering will void any warranty claims. The valve can only be locked in the closed position.

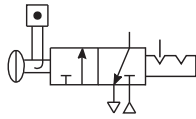
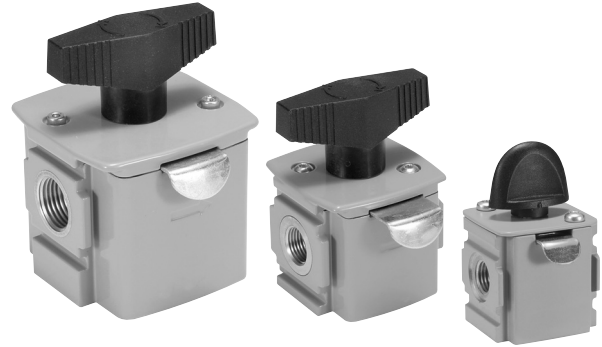

### Ordering Information

Model type	Port size	Exhaust port	Thread type	Flow scfm (dm <sup>3</sup> /s, ANR)	Modular ball valve flow from left to right
P31	1/4"	1/4"	NPT	42.4 (20)	<b>P31VB92LBNN</b>
P32	3/8"	1/4"	NPT	190.7 (90)	<b>P32VB93LBNN</b>
	1/2"	1/4"	NPT	258.5 (122)	<b>P32VB94LBNN</b>
P33	1/2"	1/2"	NPT	561.5 (265)	<b>P33VB94LBNN</b>
	3/4"	1/2"	NPT	678 (320)	<b>P33VB96LBNN</b>

\* Lockout tab and muffler supplied with unit.

For thread type:   BSPP **1**  
                           BSPT **2**  
                           NPT **9**

### Operating information

Operating temperature:	-40°C to 80°C (-40°F to 176°F)
Pressure supply (max):	250 psig (17 bar)
Port size:	BSPP / BSPT / NPT
	1/4, 3/8, 1/2, 3/4
Weight:	P31 0.33 lbs (0.15 kg)
	P32 0.79 lbs (0.36 kg)
	P33 1.21 lbs (0.55 kg)

### Material Specifications

Body	Aluminum
Seals	PTFE
Ball	Stainless Steel
Lockout Tab	Zinc Plated Steel
Screw	Zinc Plated Steel

### Dimensions inches (mm)

#### P31

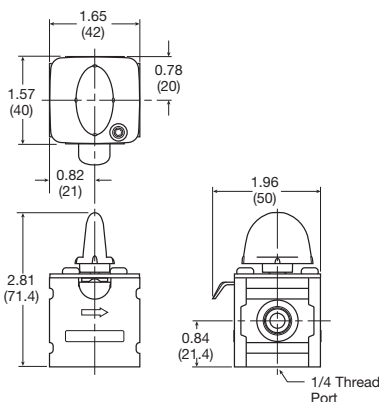

#### P32

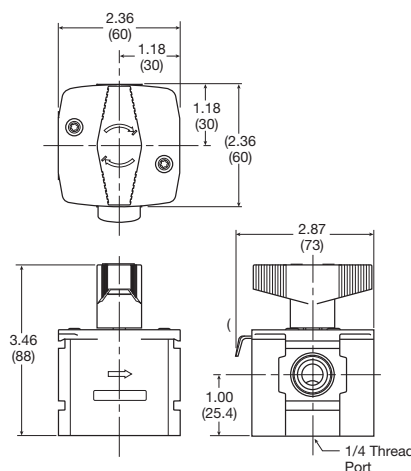

#### P33

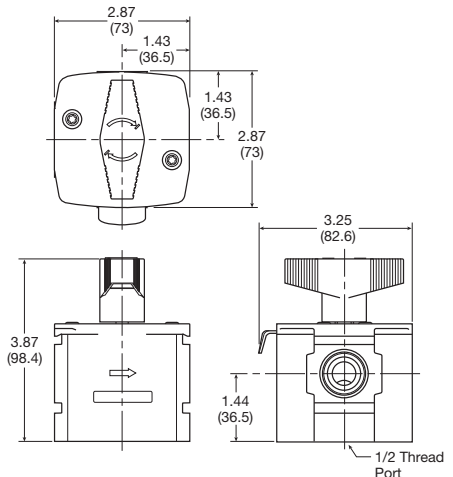

Most popular.



For inventory, lead times, and kit lookup, visit [www.pdnplu.com](http://www.pdnplu.com)

B70

**Parker Hannifin Corporation**  
 Pneumatic Division  
 Richland, Michigan  
[www.parker.com/pneumatics](http://www.parker.com/pneumatics)

## Manifold Blocks

- Available in 1/4" or 3/4" threaded inlet / outlet ports
- Two additional top and bottom auxiliary ports standard
- Can be mounted anywhere in the FRL system

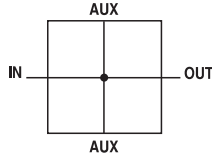

### Ordering Information

Model type	In / Out port size	Auxiliary port size top	Auxiliary port size bottom	Thread type	Part number
P31	1/4"	1/4"	1/4"	NPT	<b>P31MA92022N</b>
P32	1/2"	1/4"	1/2"	NPT	<b>P32MA94024N</b>
P33	3/4"	1/4"	1/2"	NPT	<b>P33MA96024N</b>

For thread type: BSPP **1**  
 BSPT **2**  
 NPT **9**

### Operating information

Operating temperature:	-40°F to 150°F (-40°C to 65.5°C)
Pressure supply (max):	300 psig (20.7 bar)
Weight:	P31 0.26 lbs (0.12 kg)
	P32 0.45 lbs (0.20 kg)
	P33 0.45 lbs (0.20 kg)

### Material Specifications

Body	Aluminum
------	----------

### Dimensions inches (mm)

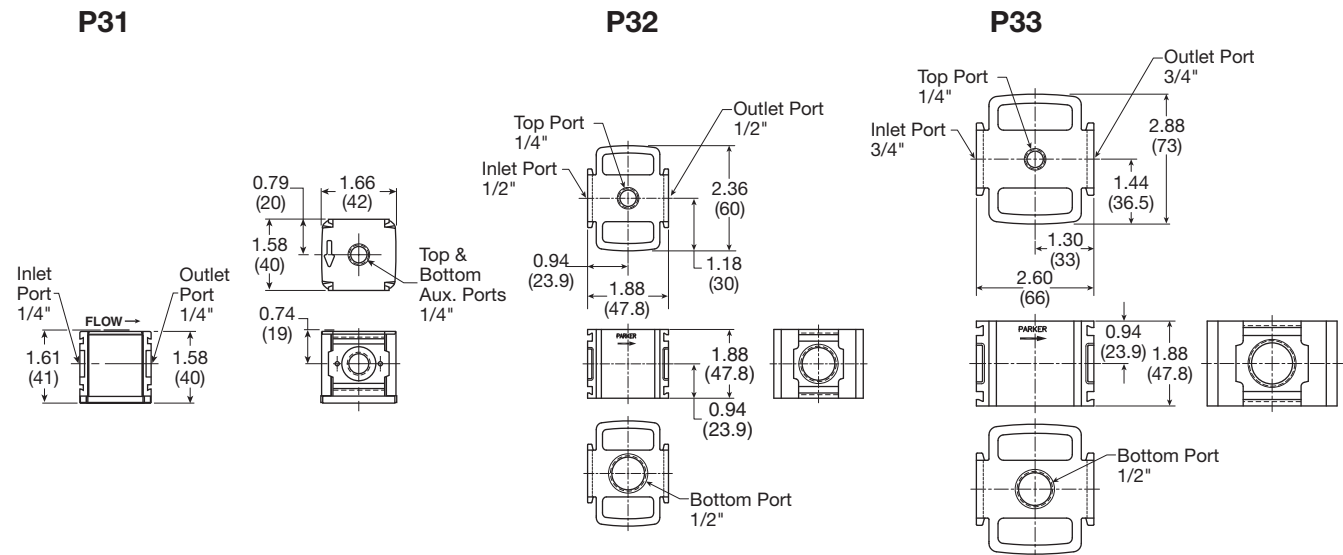

  Most popular.



For inventory, lead time, and kit lookup, visit [www.pdnplu.com](http://www.pdnplu.com)

B71

**Parker Hannifin Corporation**  
 Pneumatic Division  
 Richland, Michigan  
[www.parker.com/pneumatics](http://www.parker.com/pneumatics)

**B**

Global Air Preparation

Introduction

Filters

Coalescers

Regulators

Filter/Regulators

Lubricators

Combinations

Accessories and Kits

## PPS1 Pressure Switch

- Long life elastomer diaphragm
- High quality snap action switch
- Field adjustable
- Compact design
- Easily customized
- Quick delivery
- NEMA 4, 13

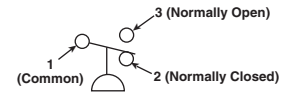

### Definitions and Terminology

**Repeatability** — Accuracy is the maximum allowable set point deviation of a single pressure or temperature switch under one given set of environmental and operational conditions.

**Single Pole Double Throw (SPDT) Switching element** — A SPDT switching element has one normally open, one normally closed and one common terminal. Three terminals mean that the switch can be wired with the circuit either normally open (NO), or normally closed (NC), or both.

**Dead Band** — The dead band, sometimes referred to as “differential” or “hysteresis”, is the change in pressure between actuation and deactuation set points.

### Operating information

Temperature range:	-40°F to 105°F (-40°C to 220°C)
Operating pressure range:	1, 2, 3 - 250 PSI (17.2 bar) 4 - 2000 PSI (137.9 bar)
Set point tolerance	±1 PSI or 5% (.07 bar)
Deadband	10 - 20% of set pressure
Current rating	3A @ 125 VAC 2A @ 30 VDC (Resistive)
Circuit form	SPDT Standard
Cycle life	1 Million

### Ordering Information:

**PPS1 - 1 C 3 - R HM**

Thread	
1/4" NPT male	1
1/8" NPT male	2
1/4" BSPP male	17
1/8" BSPP male	18

Set Point Direction	
R	Rising

Electrical Connection	
HM	DIN 9.4mm
WL	Wire leads 18"

Range*	
1	3-10 PSI
2	6-30 PSI
3	20-120 PSI
4†	100-400 PSI

\* Factory setting for calibration purposes  
Range 1 = 6 PSI  
Range 2 = 18 PSI  
Range 3 = 70 PSI  
Range 4 = 250 PSI

† Only available in 1/4" NPT

**Circuit**  
SPDT C

**Note: Switch is field adjustable.**

### Material Specifications

Adjustment knob	Anodized aluminum
Body	Brass
Diaphragm	Nitrile

### Operation

The pressure switch monitors the air pressure in your pneumatic system. When the pressure in your system either drops below or exceeds the set point pressure, an electrical output is given.

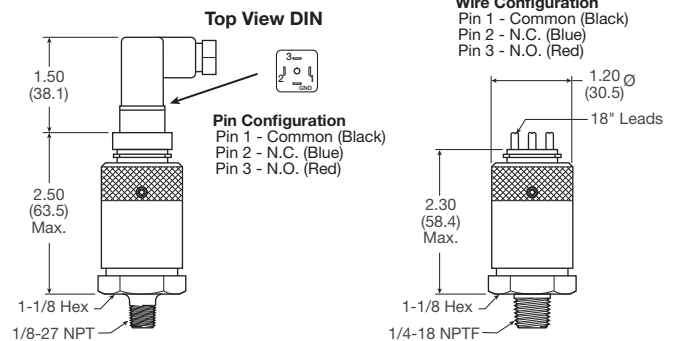
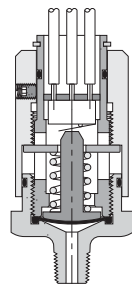



**P31 Accessories**

**C-Bracket**  
 (Fits to filter and lubricator body)  
**P31KA00MW**

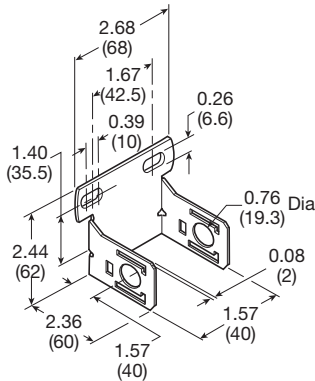
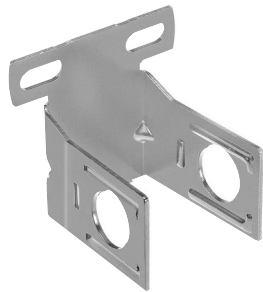

**T-Bracket w/ Body Connector**  
 (O-ring not shown)  
**P31KA00MT**

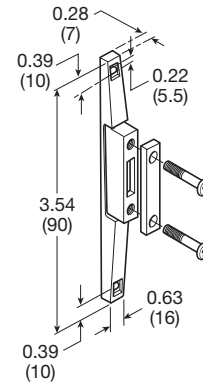

**Body Connector**  
 (O-ring not shown)  
**P31KA00CB**

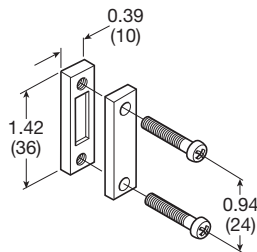
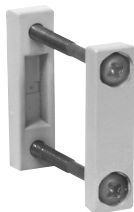

**Port Block Kit**  
 (O-ring not shown)

- |                |                  |                |                  |
|----------------|------------------|----------------|------------------|
| 1/8 NPT .....  | <b>P31KA91CP</b> | 1/8 BSPT ..... | <b>P31KA21CP</b> |
| 1/4 NPT .....  | <b>P31KA92CP</b> | 1/4 BSPT ..... | <b>P31KA22CP</b> |
| 3/8 NPT .....  | <b>P31KA93CP</b> | 3/8 BSPT ..... | <b>P31KA23CP</b> |
| 1/8 BSPP ..... | <b>P31KA11CP</b> |                |                  |
| 1/4 BSPP ..... | <b>P31KA12CP</b> |                |                  |
| 3/8 BSPP ..... | <b>P31KA13CP</b> |                |                  |



**Port Block Kit w/ T-Bracket**  
 (O-ring not shown)

- |                |                  |                |                  |
|----------------|------------------|----------------|------------------|
| 1/8 NPT .....  | <b>P31KA91CN</b> | 1/8 BSPT ..... | <b>P31KA21CN</b> |
| 1/4 NPT .....  | <b>P31KA92CN</b> | 1/4 BSPT ..... | <b>P31KA22CN</b> |
| 3/8 NPT .....  | <b>P31KA93CN</b> | 3/8 BSPT ..... | <b>P31KA23CN</b> |
| 1/8 BSPP ..... | <b>P31KA11CN</b> |                |                  |
| 1/4 BSPP ..... | <b>P31KA12CN</b> |                |                  |
| 3/8 BSPP ..... | <b>P31KA13CN</b> |                |                  |



**Angle Bracket**  
 (Fits to regulator and filter/regulator body)  
**P31KB00MR**

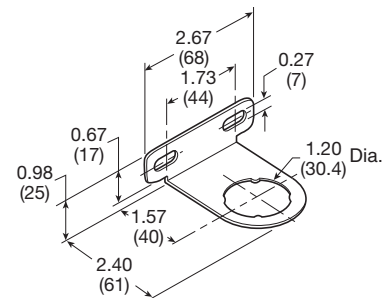

**B**

Global Air Preparation

Introduction

Filters

Coalescers

Regulators

Filter/Regulators

Lubricators

Combinations

Accessories and Kits



For inventory, lead time, and kit lookup, visit [www.pdnplu.com](http://www.pdnplu.com)

**P32 Accessories**

**T-Bracket w/ Body Connector**

P32KA00MT

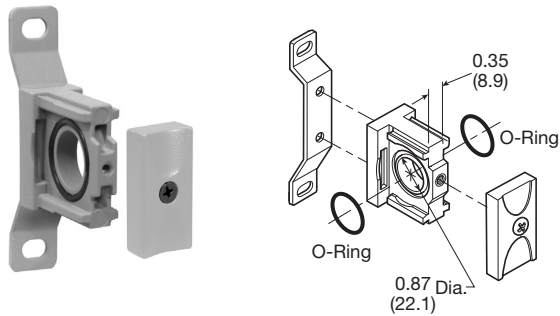

**Body Connector**

P32KA00CB

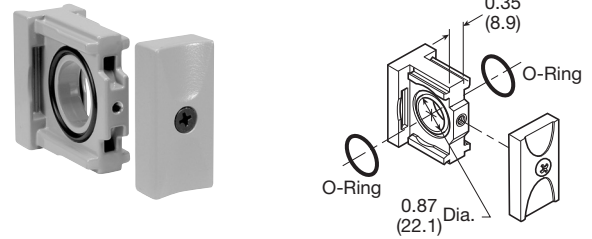

**Port Block Kit**

1/4 NPT.....	<b>P32KA92CP</b>	1/4 BSPT .....	<b>P32KA22CP</b>
3/8 NPT.....	<b>P32KA93CP</b>	3/8 BSPT .....	<b>P32KA23CP</b>
1/2 NPT.....	<b>P32KA94CP</b>	1/2 BSPT .....	<b>P32KA24CP</b>
3/4 NPT.....	<b>P32KA96CP</b>	3/4 BSPT .....	<b>P32KA26CP</b>
1/4 BSPP .....	<b>P32KA12CP</b>		
3/8 BSPP .....	<b>P32KA13CP</b>		
1/2 BSPP .....	<b>P32KA14CP</b>		
3/4 BSPP .....	<b>P32KA16CP</b>		



**Angle Bracket**

(Fits to regulator and filter/regulator bonnet)

P32KB00MR

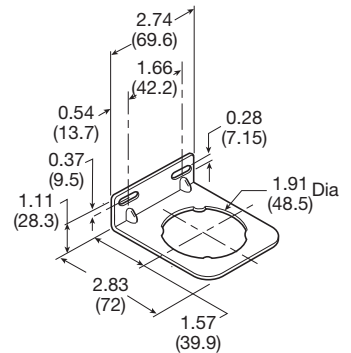

**L-Bracket**

(Fits to filter and lubricator body)

P32KA00ML

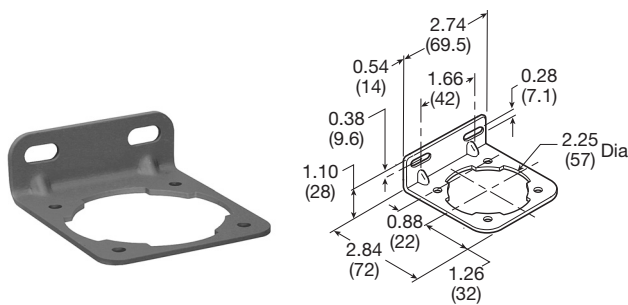

**T-Bracket**

(fits to body connector or port block)

P32KA00MB

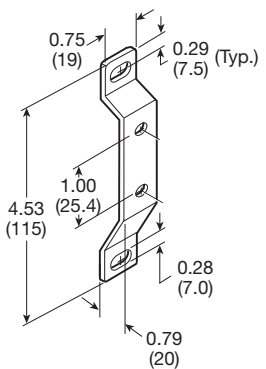

**B**  
 Global Air Preparation  
 Introduction  
 Filters  
 Coalescers  
 Regulators  
 Filter / Regulators  
 Lubricators  
 Combinations  
 Accessories and Kits



For inventory, lead times, and kit lookup, visit [www.pdnplu.com](http://www.pdnplu.com)

**P33 Accessories**

**T-Bracket w/ Body Connector**  
**P32KA00MT**

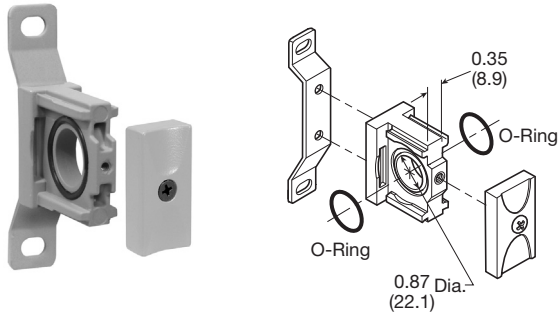

**Body Connector**  
**P32KA00CB**

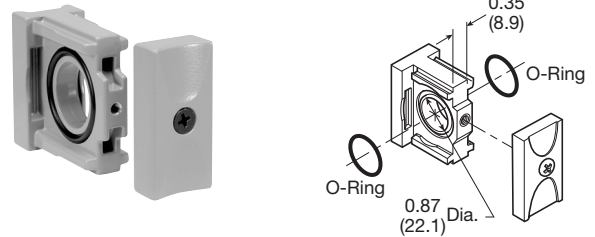

**Port Block Kit**

- |                |                  |                |                  |
|----------------|------------------|----------------|------------------|
| 1/4 NPT.....   | <b>P32KA92CP</b> | 1/4 BSPT ..... | <b>P32KA22CP</b> |
| 3/8 NPT.....   | <b>P32KA93CP</b> | 3/8 BSPT ..... | <b>P32KA23CP</b> |
| 1/2 NPT.....   | <b>P32KA94CP</b> | 1/2 BSPT ..... | <b>P32KA24CP</b> |
| 3/4 NPT.....   | <b>P32KA96CP</b> | 3/4 BSPT ..... | <b>P32KA26CP</b> |
| 1/4 BSPP ..... | <b>P32KA12CP</b> |                |                  |
| 3/8 BSPP ..... | <b>P32KA13CP</b> |                |                  |
| 1/2 BSPP ..... | <b>P32KA14CP</b> |                |                  |
| 3/4 BSPP ..... | <b>P32KA16CP</b> |                |                  |



**Angle Bracket**  
**(Fits to regulator and filter/regulator bonnet)**  
**P33KA00MR**

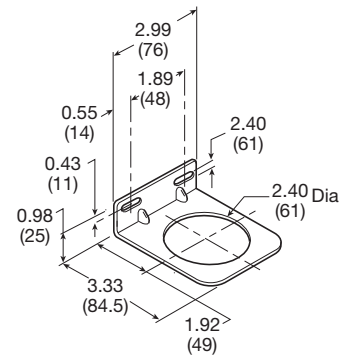



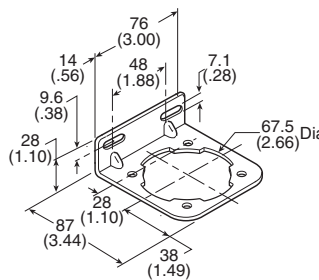



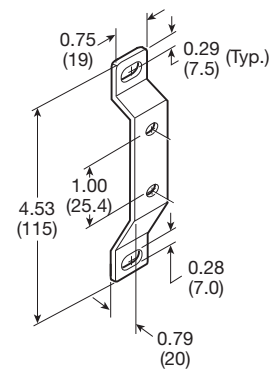



**L-Bracket**  
**(Fits to filter and lubricator body)**  
**P33KA00ML**



**T-Bracket**  
**(fits to body connector or port block)**  
**P32KA00MB**













**B**  
 Global Air Preparation  
 Introduction  
 Filters  
 Coalescers  
 Regulators  
 Filter / Regulators  
 Lubricators  
 Combinations  
 Accessories and Kits

Series	Description	Part number	
P31 P32 P33	Panel Mount Nut (Plastic)	<b>P31KA00MP</b> <b>P32KA00MP</b> <b>P33KA00MP</b>	
P31 P32 P33	Panel Mount Nut (Aluminum)	<b>P31KA00MM</b> <b>P32KA00MM</b> <b>P33KA00MM</b>	
P31 P32 P33	5µ Element Kit	<b>P31KA00ESE</b> <b>P32KA00ESE</b> <b>P33KA00ESE</b>	
P31 P32 P33	1µ Element Kit	<b>P31KA00ES9</b> <b>P32KA00ES9</b> <b>P33KA00ES9</b>	
P31 P32 P33	0.01µ Element Kit	<b>P31KA00ESC</b> <b>P32KA00ESC</b> <b>P33KA00ESC</b>	
P31 P32 P33	Adsorber Element Kit	<b>P31KA00ESA</b> <b>P32KA00ESA</b> <b>P33KA00ESA</b>	
P32 / P33	Auto Drain Kit	<b>P32KA00DA</b>	
P31 P32 / P33	Differential Pressure Indicator Kit	<b>P31KB00RQ</b> <b>P32KA00RQ</b>	
P31 / P32 / P33	Drip Control Assembly Kit	<b>P32KA00PH</b>	
P31 P32 / P33	Fill Plug Kit	<b>P31KA00PL</b> <b>P32KA00PL</b>	
P31 P32 P33	Lubricator - Plastic Bowl w/ Bowl Guard No Drain	<b>P31KB00BGN</b> <b>P32KB00BGN</b> <b>P33KA00BGN</b>	



For inventory, lead times, and kit lookup, visit [www.pdnplu.com](http://www.pdnplu.com)

Series	Description	Part number	
P31 P32 P33	Lubricator - Metal Bowl w/o Sight Gauge No Drain	<b>P31KB00BMN</b> <b>P32KB00BMN</b> <b>P33KA00BMN</b>	
P32 P33	Lubricator - Metal Bowl w/ Sight Gauge No Drain	<b>P32KB00BSN</b> <b>P33KA00BSN</b>	
P31 P32 P33	Metal Bowl w/o Sight Gauge & Manual Drain	<b>P31KB00BMM</b> <b>P32KB00BMM</b> <b>P33KA00BMM</b>	
P31	Metal Bowl w/o Sight Gauge & Pulse Drain	<b>P31KB00BMB</b>	
P32 P33	Metal Bowl w/o Sight Gauge & Auto Drain	<b>P32KB00BMA</b> <b>P33KA00BMA</b>	
P32 P33	Metal Bowl w/ Sight Gauge & Manual Drain	<b>P32KB00BSM</b> <b>P33KA00BSM</b>	
P32 P33	Metal Bowl w/ Sight Gauge & Auto Drain	<b>P32KB00BSA</b> <b>P33KA00BSA</b>	
P31 P32 P33	Plastic Bowl w/ Bowl Guard & Manual Drain	<b>P31KB00BGM</b> <b>P32KB00BGM</b> <b>P33KA00BGM</b>	
P31	Plastic Bowl w/ Bowl Guard & Pulse Drain	<b>P31KB00BGB</b>	
P32 P33	Plastic Bowl w/ Bowl Guard & Auto Drain	<b>P32KB00BGA</b> <b>P33KA00BGA</b>	
P31 P32 P33	Regulator - Relieving Repair Kit	<b>P31KB00RB</b> <b>P32KB00RB</b> <b>P33KA00RB</b>	
P31 P32 P33	Regulator - Non-Relieving Repair Kit	<b>P31KB00RC</b> <b>P32KB00RC</b> <b>P33KA00RC</b>	

**B**

Global Air  
Preparation

Introduction

Filters

Coalescers

Regulators

Filter/  
Regulators

Lubricators





Combinations

Accessories  
and Kits

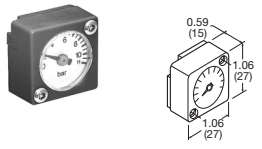
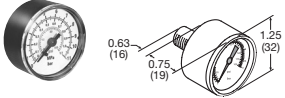
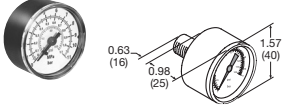
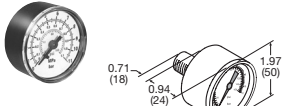

For inventory, lead time, and kit lookup, visit [www.pdnplu.com](http://www.pdnplu.com)

**PD**  
**Global Air Preparation**  
**Introduction**  
**Filters**  
**Coalescers**  
**Regulators**  
**Filter / Regulators**  
**Lubricators**  
**Combinations**  
**Accessories and Kits**

Series	Description	Connection	Part number	
P31 P32 P33	Regulator - Main Adjusting Spring 0-30 psig (0-2 bar) Kit		<b>P31KB00PR</b> <b>P32KB00PR</b> <b>P33KA00PR</b>	
P31 P32 P33	Regulator - Main Adjusting Spring 0-60 psig (0-4.1 bar) Kit		<b>P31KB00PS</b> <b>P32KB00PS</b> <b>P33KA00PS</b>	
P31 P32 P33	Regulator - Main Adjusting Spring 0-125 psig (0-8.6 bar) Kit		<b>P31KB00PT</b> <b>P32KB00PT</b> <b>P33KA00PT</b>	
P31 P32 P33	Regulator - Main Adjusting Spring 0-250 psig (0-17 bar) Kit		<b>P31KB00PV</b> <b>P32KB00PV</b> <b>P33KA00PV</b>	
P31	Square Flush Mounting Gauge Kit	0-60 psig 0-160 psig 0-4 bar 0-11 bar	<b>K4511SCR060</b> <b>K4511SCR160</b> <b>K4511SCR04B</b> <b>K4511SCR11B</b>	
P31 / P32	Square Mounting Gauge with Adapter Kit	0-60 psig 0-160 psig 0-4 bar 0-11 bar	<b>P6G-PR90060</b> <b>P6G-PR90160</b> <b>P6G-PR10040</b> <b>P6G-PR10110</b>	
P31	1" Round Gauge	0-60 psig / 0-4.1 bar 1/8" 0-160 psig / 0-10 bar 1/8"	<b>K4510N18060</b> <b>K4510N18160</b>	
P31	40mm Round Gauge	0-30 psig / 0-2 bar 1/8" 0-60 psig / 0-4.1 bar 1/8" 0-160 psig / 0-10 bar 1/8"	<b>K4515N18030</b> <b>K4515N18060</b> <b>K4515N18160</b>	
P32 / P33	50mm Round Gauge	0-30 psig / 0-2 bar 1/4" 0-60 psig / 0-4.1 bar 1/4" 0-160 psig / 0-10 bar 1/4" 0-300 psig / 0-20 bar 1/4"	<b>K4520N14030</b> <b>K4520N14060</b> <b>K4520N14160</b> <b>K4520N14300</b>	
P31 P32 / P33	Body Connector O-ring (Replacement kit) (Pack of 10)		<b>P31KA00CY</b> <b>P32KA00CY</b>	
P31 P32	Tamperproof Knob Kit		<b>P31KB00AT</b> <b>P32KB00AT</b>	
P31 P32	Tamperproof Lockable Kit		<b>P31KB00AL</b> <b>P32KB00AL</b>	



For inventory, lead times, and kit lookup, visit [www.pdnplu.com](http://www.pdnplu.com)

## Solenoid Operators - CNOMO

### Solenoid operators, coil combinations

	NC Normal Operator with 22 x 30 standard coil	NC Normal Operator with 30 x 30 standard coil
Working pressure	0 to 10 bar	0 to 10 bar
Ambient temperature	-10°C to 60°C *	-10°C to 60°C *
Power (DC)	4.8W	2.7W
Power (AC)	8.5VA	4.9VA
Voltage tolerance	+/-10%	+/-10%
Duty cycle	100%	100%
Insulation class	F	F
Electric connection	B Industrial	DIN 43650A
Protection	IP65	IP65
Approval		UL/CSA
Working media	All neutral media such as compressed air	

\* Limited to 50°C if use with 100% duty cycle

### Transients

Interrupting the current through the solenoid coil produces momentary voltage peaks which, under unfavorable conditions, can amount to several hundred times the rated operating voltage. Normally, these transients do not cause problems, but to achieve the Maximum life of relays in the circuit (and particularly of transistors, thyristors and integrated circuits) it is desirable to provide protection by means of voltage-dependent resistors (varistors). All connectors/cable plugs EN175301-803 with LED's include this type of circuit protection.

### Materials

#### Pilot Valve

Body:	Polyamide
Armature tube:	Brass
Plunger & core:	Corrosion resistant Cr-Ni steel
Seals:	Fluorocarbon
Screws:	Stainless steel

#### Coil

Encapsulation material:	Thermoplastic as standard Duroplast for M12 connection
-------------------------	-----------------------------------------------------------

### P31 Series only - Solenoid coils 15mm NC

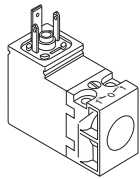

Voltage	Order code Override, blue, non-locking flush	Weight (Kg)
24VDC	<b>PS2982B49P</b>	0.038
115VAC 50Hz / 120VAC 60Hz	<b>PS2982B53P</b>	0.038

### Solenoid Coils with M12 Connection

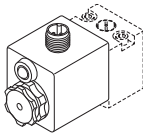

Voltage	Part number	Weight (Kg)
Direct current		
24VDC	<b>P2FC6449</b>	0.065

### Spare Base Solenoid Pilot Operator CNOMO NC

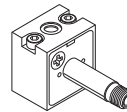

Description	Part number non-lock manual override	Weight (Kg)
Standard Duty	<b>P2FP23N4B</b>	0.065
No Override	<b>P2FP23N4A</b>	0.065

**Note:** Solenoid pilot operators are fitted to the Global range. Order the above part numbers for spares. The operators are supplied with mounting screws and interface 'O' rings. Coils and connectors must be ordered separately.

### Solenoid Coils with DIN A or Industrial B Connection

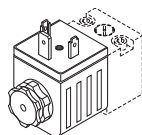

Voltage	22mm x 30mm Part number B industrial standard	Weight (Kg)	30mm x 30mm Part number DIN 43650A standard	Weight (Kg)
Direct current				
24VDC	<b>P2FCB449</b>	0.093	<b>P2FCA449</b>	0.105
Alternative current				
110V 50Hz, 120V 60Hz	<b>P2FCB453</b>	0.093	<b>P2FCA453</b>	0.105

Most popular.



For inventory, lead time, and kit lookup, visit [www.pdnplu.com](http://www.pdnplu.com)

**Solenoid Connectors / Cable Plugs EN175301-803**

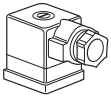
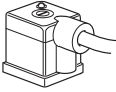
	Description	Part number 22mm Form B Industrial	Part number 30mm Form A DIN 43650A
	With standard screw	<b>PS2429BP</b>	<b>PS2028BP</b>
	With LED and protection 24VAC/DC	<b>PS243079BP</b>	<b>PS203279BP</b>
	With LED and protection 110VAC	<b>PS243083BP</b>	<b>PS203283BP</b>
	With cable	<b>PS2429JBP</b>	<b>PS2028JCP</b>
	24VAC/DC, 2m cable LED and protection IP65	<b>PS2430J79BP</b>	<b>PS2032J79CP</b>
	110VAC/DC, 2m cable LED and protection IP65	<b>PS2430J83BP</b>	<b>PS2032J83CP</b>

**Solenoid coil dimensions inches (mm)**

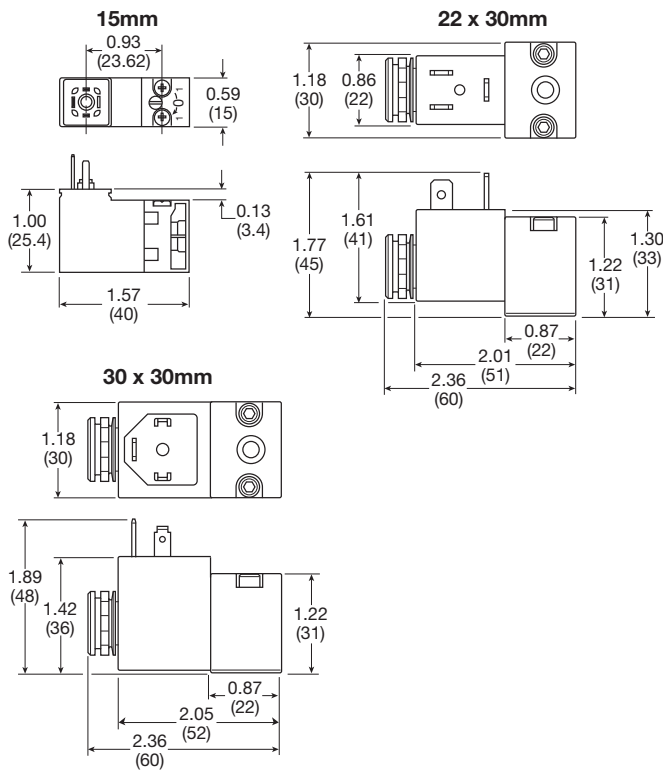

**Electrical schematics**



<b>PS2028BP</b>	<b>PS243079BP</b>	<b>PS203279BP</b>
<b>PS2028JBP</b>	<b>PS2430J79BP</b>	<b>PS2032J79CP</b>
<b>PS2429BP</b>	<b>PS243083BP</b>	<b>PS203283BP</b>
<b>PS2429JBP</b>	<b>PS2430J83BP</b>	<b>PS2032J83CP</b>
<b>PS2932BP</b>	<b>PS294679BP</b>	<b>PS294683BP</b>
<b>PS2932JBP</b>	<b>PS2946J79BP</b>	<b>PS2946J83BP</b>

**Cable plug dimensions inches (mm)**

<b>22mm Form B Industrial Cable plugs</b>	<b>PS2429BP</b>	<b>30mm DIN 43650A Cable plugs</b>	<b>PS2028BP</b>
-----------------------------------------------	-----------------	----------------------------------------	-----------------

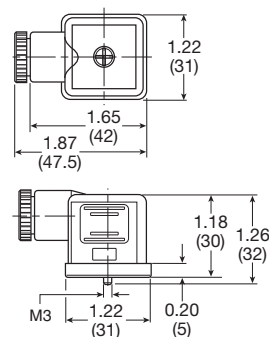
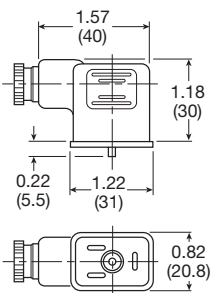

Most popular.



For inventory, lead times, and kit lookup, visit [www.pdnplu.com](http://www.pdnplu.com)

**B**  
 Global Air Preparation  
 Introduction  
 Filters  
 Coalescers  
 Regulators  
 Filter / Regulators  
 Lubricators  
 Combinations  
 Accessories and Kits



# Safety Guide For Selecting And Using Pneumatic Division Products And Related Accessories

## WARNING:

**FAILURE OR IMPROPER SELECTION OR IMPROPER USE OF PNEUMATIC DIVISION PRODUCTS, ASSEMBLIES OR RELATED ITEMS ("PRODUCTS") CAN CAUSE DEATH, PERSONAL INJURY, AND PROPERTY DAMAGE. POSSIBLE CONSEQUENCES OF FAILURE OR IMPROPER SELECTION OR IMPROPER USE OF THESE PRODUCTS INCLUDE BUT ARE NOT LIMITED TO:**

- Unintended or mistimed cycling or motion of machine members or failure to cycle
- Work pieces or component parts being thrown off at high speeds.
- Failure of a device to function properly for example, failure to clamp or unclamp an associated item or device.
- Explosion
- Suddenly moving or falling objects.
- Release of toxic or otherwise injurious liquids or gasses.

Before selecting or using any of these Products, it is important that you read and follow the instructions below.

## 1. GENERAL INSTRUCTIONS

- 1.1. Scope:** This safety guide is designed to cover general guidelines on the installation, use, and maintenance of Pneumatic Division Valves, FRLs (Filters, Pressure Regulators, and Lubricators), Vacuum products and related accessory components.
- 1.2. Fail-Safe:** Valves, FRLs, Vacuum products and their related components can and do fail without warning for many reasons. Design all systems and equipment in a fail-safe mode, so that failure of associated valves, FRLs or Vacuum products will not endanger persons or property.
- 1.3 Relevant International Standards:** For a good guide to the application of a broad spectrum of pneumatic fluid power devices see: ISO 4414:1998, Pneumatic Fluid Power – General Rules Relating to Systems. See [www.iso.org](http://www.iso.org) for ordering information.
- 1.4. Distribution:** Provide a copy of this safety guide to each person that is responsible for selection, installation, or use of Valves, FRLs or Vacuum products. Do not select, or use Parker valves, FRLs or vacuum products without thoroughly reading and understanding this safety guide as well as the specific Parker publications for the products considered or selected.
- 1.5. User Responsibility:** Due to the wide variety of operating conditions and applications for valves, FRLs, and vacuum products Parker and its distributors do not represent or warrant that any particular valve, FRL or vacuum product is suitable for any specific end use system. This safety guide does not analyze all technical parameters that must be considered in selecting a product. The user, through its own analysis and testing, is solely responsible for:
  - Making the final selection of the appropriate valve, FRL, Vacuum component, or accessory.
  - Assuring that all user's performance, endurance, maintenance, safety, and warning requirements are met and that the application presents no health or safety hazards.
  - Complying with all existing warning labels and / or providing all appropriate health and safety warnings on the equipment on which the valves, FRLs or Vacuum products are used; and,
  - Assuring compliance with all applicable government and industry standards.
- 1.6. Safety Devices:** Safety devices should not be removed, or defeated.
- 1.7. Warning Labels:** Warning labels should not be removed, painted over or otherwise obscured.
- 1.8. Additional Questions:** Call the appropriate Parker technical service department if you have any questions or require any additional information. See the Parker publication for the product being considered or used, or call 1-800-CPARKER, or go to [www.parker.com](http://www.parker.com), for telephone numbers of the appropriate technical service department.

## 2. PRODUCT SELECTION INSTRUCTIONS

- 2.1. Flow Rate:** The flow rate requirements of a system are frequently the primary consideration when designing any pneumatic system. System components need to be able to provide adequate flow and pressure for the desired application.
- 2.2. Pressure Rating:** Never exceed the rated pressure of a product. Consult product labeling, Pneumatic Division catalogs or the instruction sheets supplied for maximum pressure ratings.
- 2.3. Temperature Rating:** Never exceed the temperature rating of a product. Excessive heat can shorten the life expectancy of a product and result in complete product failure.
- 2.4. Environment:** Many environmental conditions can affect the integrity and suitability of a product for a given application. Pneumatic Division products are designed for use in general purpose industrial applications. If these products are to be used in unusual circumstances such as direct sunlight and/or corrosive or caustic environments, such use can shorten the useful life and lead to premature failure of a product.
- 2.5. Lubrication and Compressor Carryover:** Some modern synthetic oils can and will attack nitrile seals. If there is any possibility of synthetic oils or greases migrating into the pneumatic components check for compatibility with the seal materials used. Consult the factory or product literature for materials of construction.
- 2.6. Polycarbonate Bowls and Sight Glasses:** To avoid potential polycarbonate bowl failures:
  - Do not locate polycarbonate bowls or sight glasses in areas where they could be subject to direct sunlight, impact blow, or temperatures outside of the rated range.
  - Do not expose or clean polycarbonate bowls with detergents, chlorinated hydro-carbons, ketones, esters or certain alcohols.
  - Do not use polycarbonate bowls or sight glasses in air systems where compressors are lubricated with fire resistant fluids such as phosphate ester and di-ester lubricants.



**2.7. Chemical Compatibility:** For more information on plastic component chemical compatibility see Pneumatic Division technical bulletins Tec-3, Tec-4, and Tec-5

- 2.8. Product Rupture:** Product rupture can cause death, serious personal injury, and property damage.
- Do not connect pressure regulators or other Pneumatic Division products to bottled gas cylinders.
  - Do not exceed the maximum primary pressure rating of any pressure regulator or any system component.
  - Consult product labeling or product literature for pressure rating limitations.

**3. PRODUCT ASSEMBLY AND INSTALLATION INSTRUCTIONS**

- 3.1. Component Inspection:** Prior to assembly or installation a careful examination of the valves, FRLs or vacuum products must be performed. All components must be checked for correct style, size, and catalog number. DO NOT use any component that displays any signs of nonconformance.
- 3.2. Installation Instructions:** Parker published Installation Instructions must be followed for installation of Parker valves, FRLs and vacuum components. These instructions are provided with every Parker valve or FRL sold, or by calling 1-800-CPARKER, or at [www.parker.com](http://www.parker.com).
- 3.3. Air Supply:** The air supply or control medium supplied to Valves, FRLs and Vacuum components must be moisture-free if ambient temperature can drop below freezing

**4. VALVE AND FRL MAINTENANCE AND REPLACEMENT INSTRUCTIONS**

**4.1. Maintenance:** Even with proper selection and installation, valve, FRL and vacuum products service life may be significantly reduced without a continuing maintenance program. The severity of the application, risk potential from a component failure, and experience with any known failures in the application or in similar applications should determine the frequency of inspections and the servicing or replacement of Pneumatic Division products so that products are replaced before any failure occurs. A maintenance program must be established and followed by the user and, at minimum, must include instructions 4.2 through 4.9.

**4.2. Installation and Service Instructions:** Before attempting to service or replace any worn or damaged parts consult the appropriate Service Bulletin for the valve or FRL in question for the appropriate practices to service the unit in question. These Service and Installation Instructions are provided with every Parker valve and FRL sold, or are available by calling 1-800-CPARKER, or by accessing the Parker web site at [www.parker.com](http://www.parker.com).

**4.3. Lockout / Tagout Procedures:** Be sure to follow all required lockout and tagout procedures when servicing equipment. For more information see: OSHA Standard – 29 CFR, Part 1910.147, Appendix A, The Control of Hazardous Energy – (Lockout / Tagout)

- 4.4. Visual Inspection:** Any of the following conditions requires immediate system shut down and replacement of worn or damaged components:
- Air leakage: Look and listen to see if there are any signs of visual damage to any of the components in the system. Leakage is an indication of worn or damaged components.
  - Damaged or degraded components: Look to see if there are any visible signs of wear or component degradation.
  - Kinked, crushed, or damaged hoses. Kinked hoses can result in restricted air flow and lead to unpredictable system behavior.
  - Any observed improper system or component function: Immediately shut down the system and correct malfunction.
  - Excessive dirt build-up: Dirt and clutter can mask potentially hazardous situations.

**Caution: Leak detection solutions should be rinsed off after use.**

**4.5. Routine Maintenance Issues:**

- Remove excessive dirt, grime and clutter from work areas.
- Make sure all required guards and shields are in place.

**4.6. Functional Test:** Before initiating automatic operation, operate the system manually to make sure all required functions operate properly and safely.

**4.7. Service or Replacement Intervals:** It is the user’s responsibility to establish appropriate service intervals. Valves, FRLs and vacuum products contain components that age, harden, wear, and otherwise deteriorate over time. Environmental conditions can significantly accelerate this process. Valves, FRLs and vacuum components need to be serviced or replaced on routine intervals. Service intervals need to be established based on:

- Previous performance experiences.
- Government and / or industrial standards.
- When failures could result in unacceptable down time, equipment damage or personal injury risk.

**4.8. Servicing or Replacing of any Worn or Damaged Parts:** To avoid unpredictable system behavior that can cause death, personal injury and property damage:

- Follow all government, state and local safety and servicing practices prior to service including but not limited to all OSHA Lockout Tagout procedures (OSHA Standard – 29 CFR, Part 1910.147, Appendix A, The Control of Hazardous Energy – Lockout / Tagout).
- Disconnect electrical supply (when necessary) before installation, servicing, or conversion.
- Disconnect air supply and depressurize all air lines connected to system and Pneumatic Division products before installation, service, or conversion.
- Installation, servicing, and / or conversion of these products must be performed by knowledgeable personnel who understand how pneumatic products are to be applied.
- After installation, servicing, or conversions air and electrical supplies (when necessary) should be connected and the product tested for proper function and leakage. If audible leakage is present, or if the product does not operate properly, do not put product or system into use.
- Warnings and specifications on the product should not be covered or painted over. If masking is not possible, contact your local representative for replacement labels.

**4.9. Putting Serviced System Back into Operation:** Follow the guidelines above and all relevant Installation and Maintenance Instructions supplied with the valve FRL or vacuum component to insure proper function of the system.

Part Number  
Index

Safety Guide

Offer of Sale

Part Number Index,  
Safety Guide, Offer of Sale



For inventory, lead time, and kit lookup, visit [www.pdnplu.com](http://www.pdnplu.com)

**PARKER-HANNIFIN CORPORATION**  
**OFFER OF SALE**

1. **Definitions.** As used herein, the following terms have the meanings indicated.

Buyer:	means any customer receiving a Quote for Products from Seller.
Goods:	means any tangible part, system or component to be supplied by the Seller.
Products:	means the Goods, Services and/or Software as described in a Quote provided by the Seller.
Quote:	means the offer or proposal made by Seller to Buyer for the supply of Products.
Seller:	means Parker-Hannifin Corporation, including all divisions and businesses thereof.
Services:	means any services to be supplied by the Seller.
Software:	means any software related to the Products, whether embedded or separately downloaded.
Terms:	means the terms and conditions of this Offer of Sale or any newer version of the same as published by Seller electronically at <a href="http://www.parker.com/saleterms">www.parker.com/saleterms</a> .

2. **Terms.** All sales of Products by Seller are contingent upon, and will be governed by, these Terms and, these Terms are incorporated into any Quote provided by Seller to any Buyer. Buyer's order for any Products whether communicated to Seller verbally, in writing, by electronic data interface or other electronic commerce, shall constitute acceptance of these Terms. Seller objects to any contrary or additional terms or conditions of Buyer. Reference in Seller's order acknowledgement to Buyer's purchase order or purchase order number shall in no way constitute an acceptance of any of Buyer's terms of purchase. No modification to these Terms will be binding on Seller unless agreed to in writing and signed by an authorized representative of Seller.

3. **Price; Payment.** The Products set forth in Seller's Quote are offered for sale at the prices indicated in Seller's Quote. Unless otherwise specifically stated in Seller's Quote, prices are valid for thirty (30) days and do not include any sales, use, or other taxes or duties. Seller reserves the right to modify prices at any time to adjust for any raw material price fluctuations. Unless otherwise specified by Seller, all prices are F.C.A. Seller's facility (INCOTERMS 2010). All sales are contingent upon credit approval and payment for all purchases is due thirty (30) days from the date of invoice (or such date as may be specified in the Quote). Unpaid invoices beyond the specified payment date incur interest at the rate of 1.5% per month or the maximum allowable rate under applicable law.

4. **Shipment; Delivery; Title and Risk of Loss.** All delivery dates are approximate. Seller is not responsible for damages resulting from any delay. Regardless of the manner of shipment, delivery occurs and title and risk of loss or damage pass to Buyer, upon placement of the Products with the shipment carrier at Seller's facility. Unless otherwise agreed, Seller may exercise its judgment in choosing the carrier and means of delivery. No deferment of shipment at Buyer's request beyond the respective indicated shipping date will be made except on terms that will indemnify, defend and hold Seller harmless against all loss and additional expense. Buyer shall be responsible for any additional shipping charges incurred by Seller due to Buyer's acts or omissions.

5. **Warranty.** The warranty related to the Products is as follows: (i) Goods are warranted against defects in material or workmanship for a period of twelve (12) months from the date of delivery or 2,000 hours of use, whichever occurs first; (ii) Services shall be performed in accordance with generally accepted practices and using the degree of care and skill that is ordinarily exercised and customary in the field to which the Services pertain and are warranted for a period of six (6) months from the completion of the Services by Seller; and (iii) Software is only warranted to perform in accordance with applicable specifications provided by Seller to Buyer for ninety (90) days from the date of delivery or, when downloaded by a Buyer or end-user, from the date of the initial download. All prices are based upon the exclusive limited warranty stated above, and upon the following disclaimer:

**DISCLAIMER OF WARRANTY: THIS WARRANTY IS THE SOLE AND ENTIRE WARRANTY PERTAINING TO PRODUCTS. SELLER DISCLAIMS ALL OTHER WARRANTIES, EXPRESS AND IMPLIED, INCLUDING DESIGN, NONINFRINGEMENT, MERCHANTABILITY, AND FITNESS FOR A PARTICULAR PURPOSE. SELLER DOES NOT WARRANT THAT THE SOFTWARE IS ERROR-FREE OR FAULT-TOLERANT, OR THAT BUYER'S USE THEREOF WILL BE SECURE OR UNINTERRUPTED. BUYER AGREES AND ACKNOWLEDGES THAT UNLESS OTHERWISE AUTHORIZED IN WRITING BY SELLER THE SOFTWARE SHALL NOT BE USED IN CONNECTION WITH HAZARDOUS OR HIGH RISK ACTIVITIES OR ENVIRONMENTS. EXCEPT AS EXPRESSLY STATED HEREIN, ALL PRODUCTS ARE PROVIDED "AS IS".**

6. **Claims; Commencement of Actions.** Buyer shall promptly inspect all Products upon receipt. No claims for shortages will be allowed unless reported to the Seller within ten (10) days of delivery. Buyer shall notify Seller of any alleged breach of warranty within thirty (30) days after the date the non-conformance is or should have been discovered by Buyer. Any claim or action against Seller based upon breach of contract or any other theory, including tort, negligence, or otherwise must be commenced within twelve (12) months from the date of the alleged breach or other alleged event, without regard to the date of discovery.

7. **LIMITATION OF LIABILITY.** IN THE EVENT OF A BREACH OF WARRANTY, SELLER WILL, AT ITS OPTION, REPAIR OR REPLACE THE NON-CONFORMING PRODUCT, RE-PERFORM THE SERVICES, OR REFUND THE PURCHASE PRICE PAID WITHIN A REASONABLE PERIOD OF TIME. IN NO EVENT IS SELLER LIABLE FOR ANY SPECIAL, INDIRECT, INCIDENTAL OR CONSEQUENTIAL DAMAGES ARISING OUT OF, OR AS THE RESULT OF, THE SALE, DELIVERY, NON-DELIVERY, SERVICING, NON-COMPLETION OF SERVICES, USE, LOSS OF USE OF, OR INABILITY TO USE THE PRODUCTS OR ANY PART THEREOF, LOSS OF DATA, IDENTITY, PRIVACY, OR CONFIDENTIALITY, OR FOR ANY CHARGES OR EXPENSES OF ANY NATURE INCURRED WITHOUT SELLER'S WRITTEN CONSENT, WHETHER BASED IN CONTRACT, TORT OR OTHER LEGAL THEORY. IN NO EVENT SHALL SELLER'S LIABILITY UNDER ANY CLAIM MADE BY BUYER EXCEED THE PURCHASE PRICE PAID FOR THE PRODUCTS.

8. **Loss to Buyer's Property.** Any designs, tools, patterns, materials, drawings, confidential information or equipment furnished by Buyer or any other items which are or become Buyer's property, will be considered obsolete and may be destroyed by Seller after two (2) consecutive years have elapsed without Buyer ordering the Products manufactured using such property. Seller shall not be responsible for any loss or damage to such property while it is in Seller's possession or control.

9. **Special Tooling.** Special Tooling includes but is not limited to tooling, jigs, fixtures and associated manufacturing equipment acquired or necessary to manufacture Products. A tooling charge may be imposed for any Special Tooling. Such Special Tooling shall be and remain Seller's property notwithstanding payment of any charges by Buyer. In no event will Buyer acquire any interest in Special Tooling belonging to Seller that is utilized in the manufacture of the Products, even if such Special Tooling has been specially converted or adapted for such manufacture and notwithstanding any charges paid by Buyer. Unless otherwise agreed, Seller has the right to alter, discard or otherwise dispose of any Special Tooling or other property in its sole discretion at any time.

10. **Security Interest.** To secure payment of all sums due, Seller retains a security interest in all Products delivered to Buyer and, Buyer's acceptance of these Terms is deemed to be a Security Agreement under the Uniform Commercial Code. Buyer authorizes Seller as its attorney to execute and file on Buyer's behalf all documents Seller deems necessary to perfect its security interest.

11. **User Responsibility.** The Buyer through its own analysis and testing, is solely responsible for making the final selection of the Products and assuring that all performance, endurance, maintenance, safety and warning requirements of the application of the Products are met. The Buyer must analyze all aspects of the application and follow applicable industry standards, specifications, and other technical information provided with the Product. If Seller provides Product options based upon data or specifications provided by the Buyer, the Buyer is responsible for determining that such data and specifications are suitable and sufficient for all applications and reasonably foreseeable uses of the Products. In the event the Buyer is not the end-user, Buyer will ensure such end-user complies with this paragraph.

12. **Use of Products; Indemnity by Buyer.** Buyer shall comply with all instructions, guides and specifications provided by Seller with the Products. **Unauthorized Uses.** If Buyer uses or resells the Products for any uses prohibited in Seller's instructions, guides or specifications, or Buyer otherwise fails to comply with Seller's instructions, guides and specifications, Buyer acknowledges that any such use, resale, or non-compliance is at Buyer's sole risk. Buyer shall indemnify, defend, and hold Seller harmless from any losses, claims, liabilities, damages, lawsuits, judgments and costs (including attorney fees and defense costs), whether for personal injury, property damage, intellectual property infringement or any other claim, brought by or incurred by Buyer, Buyer's employees, or any other person, arising out of: (a) improper selection, application, design, specification or other misuse of Products provided by Seller; (b) any act or omission, negligent or otherwise, of Buyer; (c) Seller's use of patterns, tooling, equipment, plans, drawings, designs or specifications or other information or things furnished by Buyer; (d) damage to the Products from an external cause, repair or attempted repair by anyone other than Seller, failure to follow instructions, guides and specifications provided by Seller, use with goods not provided by Seller, or opening, modifying, deconstructing or tampering with the Products for any reason; or (e) Buyer's failure to comply with these Terms. Seller shall not indemnify Buyer under any circumstance except as otherwise provided in these Terms.

13. **Cancellations and Changes.** Buyer may not cancel or modify any order for any reason, except with Seller's written consent and upon terms that will indemnify, defend and hold Seller harmless against all direct, incidental and consequential loss or damage. Seller, at any time, may change Product features, specifications, designs and availability.

14. **Limitation on Assignment.** Buyer may not assign its rights or obligations without the prior written consent of Seller.

15. **Force Majeure.** Seller does not assume the risk and is not liable for delay or failure to perform any of Seller's obligations by reason of events or circumstances beyond its reasonable control ("Events of Force Majeure"). Events of Force Majeure shall include without limitation: accidents, strikes or labor disputes, acts of any government or government agency, acts of nature, delays or failures in delivery from carriers or suppliers, shortages of materials, or any other cause beyond Seller's reasonable control.

16. **Waiver and Severability.** Failure to enforce any provision of these Terms will not invalidate that provision; nor will any such failure prejudice Seller's right to enforce that provision in the future. Invalidation of any provision of these Terms by legislation or other rule of law shall not invalidate any other provision herein and, the remaining provisions will remain in full force and effect.

17. **Termination.** Seller may terminate any agreement governed by or arising from these Terms for any reason and at any time by giving Buyer thirty (30) days prior written notice. Seller may immediately terminate, in writing, if Buyer: (a) breaches any provision of these Terms (b) appoints a trustee, receiver or custodian for all or any part of Buyer's property (c) files a petition for relief in bankruptcy on its own behalf, or one filed by a third party (d) makes an assignment for the benefit of creditors; or (e) dissolves its business or liquidates all or a majority of its assets.

18. **Ownership of Software.** Seller retains ownership of all Software supplied to Buyer hereunder. In no event shall Buyer obtain any greater right in and to the Software than a right in the nature of a license limited to the use thereof and subject to compliance with any other terms provided with the Software.

19. **Indemnity for Infringement of Intellectual Property Rights.** Seller is not liable for infringement of any patents, trademarks, copyrights, trade dress, trade secrets or similar rights ("Intellectual Property Rights") except as provided in this Section. Seller will defend at its expense and will pay the cost of any settlement or damages awarded in an action brought against Buyer based on a third party claim that one or more of the Products sold hereunder infringes the Intellectual Property Rights of a third party in the country of delivery of the Products by the Seller to the Buyer. Seller's obligation to defend and indemnify Buyer is contingent on Buyer notifying Seller within ten (10) days after Buyer becomes aware of any such claim, and Seller having sole control over the defense of the claim including all negotiations for settlement or compromise. If one or more Products sold hereunder is subject to such a claim, Seller may, at its sole expense and option, procure for Buyer the right to continue using the Products, replace or modify the Products so as to render them non-infringing, or offer to accept return of the Products and refund the purchase price less a reasonable allowance for depreciation. Seller has no obligation or liability for any claim of infringement: (i) arising from information provided by Buyer; or (ii) directed to any Products provided hereunder for which the designs are specified in whole or part by Buyer; or (iii) resulting from the modification, combination or use in a system of any Products provided hereunder. The foregoing provisions of this Section constitute Seller's sole and exclusive liability and Buyer's sole and exclusive remedy for such claims of infringement of Intellectual Property Rights.

20. **Governing Law.** These Terms and the sale and delivery of all Products are deemed to have taken place in, and shall be governed and construed in accordance with, the laws of the State of Ohio, as applicable to contracts executed and wholly performed therein and without regard to conflicts of laws principles. Buyer irrevocably agrees and consents to the exclusive jurisdiction and venue of the courts of Cuyahoga County, Ohio with respect to any dispute, controversy or claim arising out of or relating to the sale and delivery of the Products.

21. **Entire Agreement.** These Terms, along with the terms set forth in the main body of any Quote, forms the entire agreement between the Buyer and Seller and constitutes the final, complete and exclusive expression of the terms of sale. In the event of a conflict between any term set forth in the main body of a Quote and these Terms, the terms set forth in the main body of the Quote shall prevail. All prior or contemporaneous written or oral agreements or negotiations with respect to the subject matter shall have no effect. These Terms may not be modified unless in writing and signed by an authorized representative of Seller.

22. **Compliance with Laws.** Buyer agrees to comply with all applicable laws, regulations, and industry and professional standards, including those of the United States of America, and the country or countries in which Buyer may operate, including without limitation the U.S. Foreign Corrupt Practices Act ("FCPA"), the U.S. Anti-Kickback Act ("Anti-Kickback Act"), U.S. and E.U. export control and sanctions laws ("Export Laws"), the U.S. Food Drug and Cosmetic Act ("FDCA"), and the rules and regulations promulgated by the U.S. Food and Drug Administration ("FDA"), each as currently amended. Buyer agrees to indemnify, defend, and hold harmless Seller from the consequences of any violation of such laws, regulations and standards by Buyer, its employees or agents. Buyer acknowledges that it is familiar with all applicable provisions of the FCPA, the Anti-Kickback Act, Export Laws, the FDCA and the FDA and certifies that Buyer will adhere to the requirements thereof and not take any action that would make Seller violate such requirements. Buyer represents and agrees that Buyer will not make any payment or give anything of value, directly or indirectly, to any governmental official, foreign political party or official thereof, candidate for foreign political office, or commercial entity or person, for any improper purpose, including the purpose of influencing such person to purchase Products or otherwise benefit the business of Seller. Buyer further represents and agrees that it will not receive, use, service, transfer or ship any Product from Seller in a manner or for a purpose that violates Export Laws or would cause Seller to be in violation of Export Laws.