

Pneumatic Valve Products Accessories

Flow Controls & Check Valves

337 Micrometer Series	F2
338 Series	F3
3250 Series	F4-F5
3251 Series	F6
339 Series	F7
3047 Series	F7

Miscellaneous Accessories

EM Series Sintered Bronze Muffler / Filters	F8
Muffler / Flow Controls	F8
Breather Vents	F9
Silencers	F9
Stainless Steel Mufflers	F10
Air Line Silencers, Plastic	F11-F12
ECS Reclassifier	F13
Quick Exhaust & Shuttle Valves	F14-F16
Blocking Valves	F17-F18, F21
Threshold Sensors, PWS Series	F19-F21
Tank Valves	F22
Blow Guns	F23-F24

Integrated Fittings

Index	F25-F26
Compact Flow Control Valves	F27-F28
Miniature Flow Control Valves	F29
Swivel Outlet Flow Control Valves	F30
Plug-In Flow Control Valves	F31
In-Line Flow Control Valves	F32-F33
Compact Metal Flow Control Valves	F34
Flow Control Check Valves	F35-F36
Blocking Flow Control Valves	F37
Threshold Sensors	F38

337 Series Micrometer Flow Control Valves, 1/8" to 3/4" Ports

The "337" Series Flow Control Valves meter flow of air in one direction and allow free flow in the reverse direction.

Valves are manufactured with a fine tapered needle providing precise flow control, even at low flow rates. The perimeter of the adjustment knob features numerical micrometer position markings providing a visual indication of the setting. Once the desired flow is selected, a set screw can be tightened to maintain the setting.

These valves are available with NPTF ports in 1/8", 1/4", 3/8", 1/2", and 3/4" sizes. This series is recommended for pneumatic service.



Material Specifications

Body	Brass
Check Seal	Urethane
Knob	Aluminum
Needle	Stainless steel
Needle Seals	Buna N (Fluorocarbon optional – consult factory)
Retainer	Zinc- Plated Steel
Spring	Stainless Steel
Set Screw	Steel

Operating information

Maximum operating pressure: 250 PSIG
Cracking pressure for return check poppet 1 to 2 PSIG

Operating temperature: *
Standard: 0°F to 180°F
Extended: 0°F to 300°F (consult factory)

* Ambient temperatures below freezing require moisture-free air. Ambient temperatures below freezing and above 180° require lubricants especially selected for suitability at these temperatures. Pneumatic valves should be used with filtered and lubricated air.

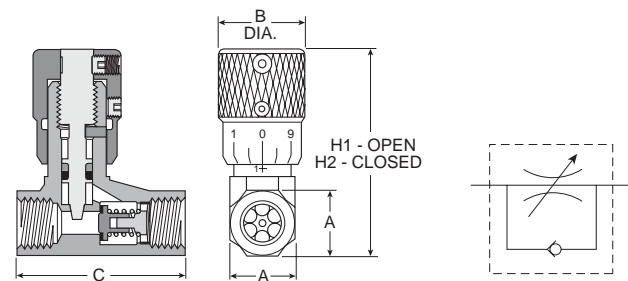

337 Micrometer Flow Control Valves – NPT

Port size	Flow (SCFM †)		A	B	C	H1	H2	Part number	Service kits
	Adj.	Free flow							
1/8"	15	32	9/16"	0.75	1.47	2.03	1.81	003371000	003378000
1/4"	28	75	11/16"	0.75	1.47	2.28	2.03	003371001	003378001
3/8"	59	139	7/8"	0.88	2.31	2.84	2.53	003371002	003378002
1/2"	126	183	1-3/16"	1.06	3.25	3.62	3.22	003371003	003378003
3/4"	140	327	1-3/8"	1.06	3.25	3.72	3.31	003371004	003378004

337 Micrometer Flow Control Valves – BSPP

Port size	Flow (SCFM †)		A	B	C	H1	H2	Part number	Service kits
	Adj.	Free flow							
1/8"	15	32	9/16"	0.75	1.47	2.03	1.81	00337G1000	003378000
1/4"	28	75	11/16"	0.75	1.47	2.28	2.03	00337G1001	003378001

† At 100 PSIG inlet pressure with full pressure drop.

Most popular.



For inventory, lead times, and kit lookup, visit www.pdnplu.com

338 Series Flow Control Valves, 1/8" to 3/4" Ports

"338" Series needle valves bi-directionally meter the flow of air through the valve.

This series features a fine tapered needle providing precise flow of air in both directions. Numerical micrometer position markings are stamped on the perimeter of the adjustment knob which provide a visual indication of the setting. Once the desired flow is selected, a set screw can be tightened to maintain the setting.

These valves are available with NPTF ports in 1/8", 1/4", 3/8" 1/2" and 3/4" sizes. This series is recommended for pneumatic service.



Material Specifications

Body	Brass
Internal Components	Stainless steel
Seals	Buna N (Fluorocarbon optional – consult factory)

Operating information

Maximum operating pressure: 250 PSIG

Operating temperature:*

Standard: 0°F to 180°F

Extended: 0°F to 300°F (consult factory)

* Ambient temperatures below freezing require moisture-free air. Ambient temperatures below freezing and above 180° require lubricants especially selected for suitability at these temperatures. Pneumatic valves should be used with filtered and lubricated air.

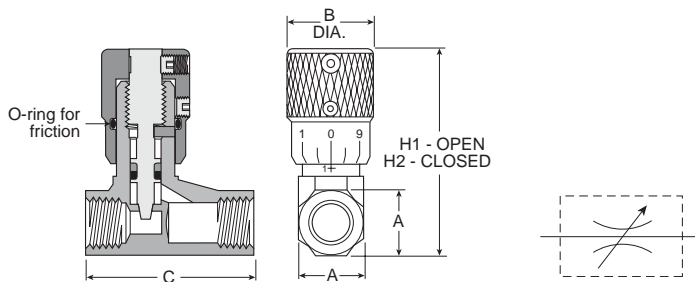

338 Needle Valves – NPT

Port size	Flow (SCFM †)	A	B	C	H1	H2	Part number	Service kits
1/8"	15	9/16"	0.75	1.47	2.03	1.81	003381100	003378000
1/4"	28	11/16"	0.75	1.47	2.28	2.03	003381101	003378001
3/8"	59	7/8"	0.88	2.31	2.84	2.53	003381102	003378002
1/2"	126	1-3/16"	1.06	3.25	3.62	3.22	003381103	003378003
3/4"	140	1-3/8"	1.06	3.25	3.72	3.31	003381104	003378004

338 Needle Valves – BSPP

Port size	Flow (SCFM †)	A	B	C	H1	H2	Part number	Service kits
1/8"	15	9/16"	0.75	1.47	2.03	1.81	00338G1100	003378000
1/4"	28	11/16"	0.75	1.47	2.28	2.03	00338G1101	003378001

† At 100 PSIG inlet pressure with full pressure drop.

 Most popular.



For inventory, lead time, and kit lookup, visit www.pdnplu.com

3250 Series Flow Control Valves, 1/8" to 3/4" Ports

The "3250" Series Flow Control Valves are specifically designed to accurately meter the flow of air in one direction and allow free flow in the opposite direction. The "3250" Series Flow Control Valves are also suitable for low pressure hydraulic service.

When air is moving in the free flow direction through the valve, it forces the poppet off its seat and unrestricted air flow is permitted.

When air is moving in the metered direction through the valve, air pressure and the force of the poppet spring causes the poppet to close. Flow must then be through the orifice that is controlled by the metering screw. Opening this screw allows more flow; closing it, less flow.



Operating information

Operating pressure:	400 PSIG (Air) 800 PSIG (Hydraulic)
Operating temperature:	Standard: -40°F to 180°F Extended: -20°F to 400°F

Valve will operate mounted in any position. Lock nut on metering screw prevents change in setting during operation.

Material Specifications

Body	Brass
Internal Components	Brass, Stainless steel
Seals	Buna N

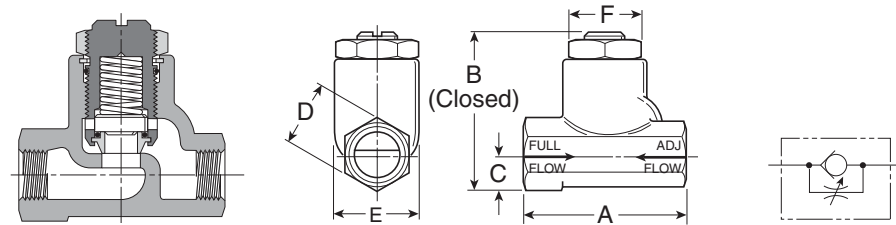

3250 Flow Control Valves, 1/8" to 3/4" Ports – NPT

Port size	Max. flow (SCFM)		A	B	C	D	E	F	Part number
	Metered direction	Free flow direction							
1/8"	70	60	1.75	1.56	0.37	0.62	0.81	0.68	032500119
1/4"	130	120	2.33	1.97	0.44	0.75	1.09	0.94	032500219
3/8"	220	205	2.66	2.44	0.56	1.00	1.38	1.19	032500319
1/2"	295	346	3.11	3.06	0.75	1.25	1.63	1.38	032500419
3/4"	420	615	3.56	3.69	0.88	1.50	2.00	1.75	032500519

3250 Flow Control Valves, 1/8" to 3/4" Ports – BSPP

Port size	Max. flow (SCFM)		A	B	C	D	E	F	Part number
	Metered direction	Free flow direction							
1/8"	70	60	1.75	1.56	0.37	0.62	0.81	0.68	3250G0119
1/4"	130	120	2.33	1.97	0.44	0.75	1.09	0.94	3250G0219
3/8"	220	205	2.66	2.44	0.56	1.00	1.38	1.19	3250G0319
1/2"	295	346	3.11	3.06	0.75	1.25	1.63	1.38	3250G0419
3/4"	420	615	3.56	3.69	0.88	1.50	2.00	1.75	3250G0519

Most popular.



For inventory, lead times, and kit lookup, visit www.pdnplu.com

3250 Series Needle Valves, 1" to 1-1/2" Ports

These extra large flow control valves have been developed to provide effective flow settings for large diameter cylinders and for other similar air applications. Each valve has a fine screw adjustment allowing precise settings which are secured by a sturdy lock nut.

Large internal port passages coupled with unique soft seal poppet and inline design provide maximum full flow capacity and minimum pressure drop in the free flow direction. Their cone shaped brass metering valve will provide consistent cylinder speed by regulating cylinder exhaust.

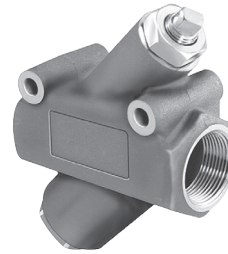

Material Specifications

Body	Cast Aluminum
Internal Components	Brass, Aluminum
Seals	Buna N, Urethane
Spring	Stainless Steel

Operating information

Maximum operating pressure:	250 PSIG
Operating temperature:	
Standard:	-40°F to 180°F
Extended:	-40°F to 350°F (consult factory)

Flow Controls
& Check Valves

Misc
Accessories

Integrated
Fittings

Accessories

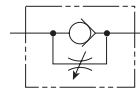
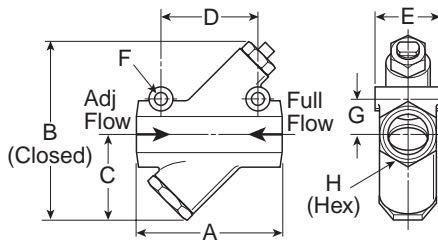
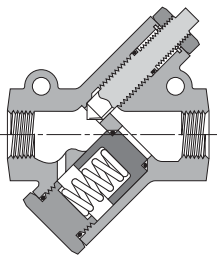

3250 Flow Control Valves, 1" to 1-1/2" Ports – NPT

Port size	Max. flow needle open		A	B	C	D	E	F	G	H	Part number
	SCFM†	Cv									
1"	70	60	5.00	6.50	3.00	3.25	2.25	.39	1.31	2.13	032501000
1-1/4"	130	120	5.00	6.50	3.00	3.25	2.25	.39	1.31	2.13	032501250
1-1/2"	295	346	5.88	8.00	3.75	3.50	2.50	.39	1.50	2.38	032501500

3250 Flow Control Valves, 1" to 1-1/2" Ports – BSPP

Port size	Max. flow needle open		A	B	C	D	E	F	G	H	Part number
	SCFM†	Cv									
1"	70	60	5.00	6.50	3.00	3.25	2.25	.39	1.31	2.13	03250G1000
1-1/4"	130	120	5.00	6.50	3.00	3.25	2.25	.39	1.31	2.13	03250G1250
1-1/2"	295	346	5.88	8.00	3.75	3.50	2.50	.39	1.50	2.38	03250G1500

† At 100 PSIG inlet pressure with full pressure drop.

Most popular.



For inventory, lead time, and kit lookup, visit www.pdnplu.com

3251 Series Right Angle Flow Control Valves, 1/8" to 1/2" Ports

The Right Angle Flow Control is an ideal solution to cylinder speed control where space is at a premium. Costly fittings, connections and piping expenses can be eliminated because the valve can rotate 360°, the piping alignment can be in any direction. It then locks into place. The 1/8" model can be rotated after final assembly.

Install by threading male end directly into cylinder port. The free-flow and metered-flow direction is automatically predetermined. Free-flow direction is into cylinder and metered-flow is out of the cylinder. Flow is adjusted with an Allen wrench and locked with nut.

Right Angle Flow Control also available with Prestolok fittings on inlet port to accommodate 5/32 - 3/8 tube sizes. This allows for quick connection and eliminates need for separate tube fitting.

Material Specifications

Body	Brass
Plunger	Brass and Acetal
Seals	Buna N



Shown with Threaded Inlet



Shown with Prestolok Inlet Fitting

Operating information

Operating pressure:	125 PSIG (863 kPa) max.
Operating temperature:	0°F to 140°F (-18°C to 60°C)

Flow Controls & Check Valves

Misc Accessories

Integrated Fittings

Accessories

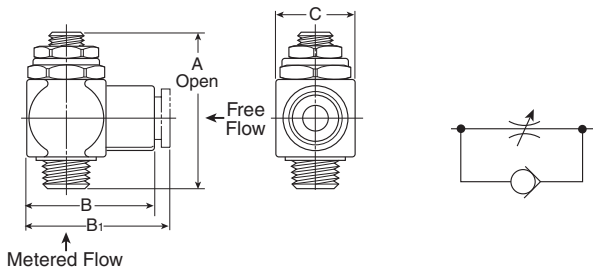

3251 Flow Control Valves – NPT

Thread (NPT) male	Thread (NPT) female	Cv		A mm	B mm	C mm	Weight		Part number
		Adjusted flow	Free flow				oz.	kg.	
1/8	1/8	0.26	0.20	44	30	17	2.0	0.9	032510125
1/4	1/4	0.75	0.68	51	36	23	4.5	2.0	032510250
3/8	3/8	0.84	0.72	58	43	27	7.0	3.2	032510375
1/2	1/2	1.64	1.41	68	53	32	11.0	5.0	032510500

With Prestolok Fittings

1/8	5/32	0.19	0.16	44	30	17	2.0	0.9	032511215
1/8	1/4	0.28	0.22	44	30	17	2.0	0.9	032511225
1/4	1/4	0.51	0.44	51	36	23	4.5	2.0	032512525
1/4	3/8	0.62	0.53	51	36	23	4.5	2.0	032512538
3/8	3/8	0.78	0.65	58	43	27	7.0	3.2	032513838

CAUTION: If it is possible that the ambient temperature may fall below freezing, the medium must be moisture-free to prevent internal damage or unpredictable behavior.

Most popular.



For inventory, lead times, and kit lookup, visit www.pdnplu.com

339 Series Check Valves, 1/8" to 3/4" Ports

"339" Series check valves allow free flow in one direction and provide positive checked flow in the reverse direction. These valves are available with NPTF ports in 1/8", 1/4", 3/8", 1/2" & 3/4" sizes. This series is recommended for pneumatic service.



Material Specifications

Body	Brass
Internal Components	Brass / stainless steel / zinc-plated steel
Seals	Urethane (standard) Fluorocarbon (optional, consult factory)

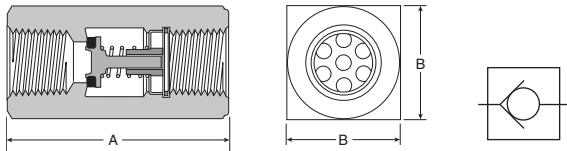

Operating information

Operating pressure: 250 PSIG max.
Cracking pressure 1 to 2 PSIG

Operating temperature: *
Standard: 0°F to 180°F
Extended Option: 0°F to 300°F (consult factory)

* Ambient temperatures below freezing require moisture-free air. Ambient temperatures below freezing and above 180° require lubricants especially selected for suitability at these temperatures. Pneumatic valves should be used with filtered and lubricated air.

339 Check Valve

Port size	Flow (SCFM †)	A	B	Part number	
				NPT	BSPP
1/8"	35	1.22	0.56	003393000	00339G3000
1/4"	75	1.34	0.69	003393001	00339G3001
3/8"	143	2.00	0.88	003393002	–
1/2"	162	2.56	1.19	003393003	–
3/4"	323	2.66	1.38	003393004	–

† At 100 PSIG inlet pressure with full pressure drop.

3047 Series Check Valves, 1/4" Ports

"3047" Series check valves allow free flow in one direction and provide positive checked flow in the reverse direction. This valve is available with a male 1/4" NPTF connection and is recommended for pneumatic service.



Material Specifications

Body	Brass
Internal Components	Brass / stainless steel
Seals	Nitrile

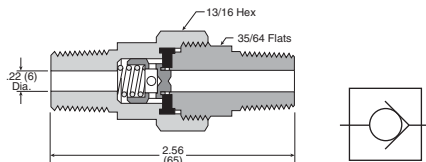

Operating information

Operating pressure: 250 PSIG max.
Cracking pressure 1 to 2 PSIG

Operating temperature: *
Standard: 0°F to 180°F

* Ambient temperatures below freezing require moisture-free air. Ambient temperatures below freezing and above 180° require lubricants especially selected for suitability at these temperatures. Pneumatic valves should be used with filtered and lubricated air.

3047 Check Valve

Port size	Flow (SCFM †)	Part number
1/4"	30	030470099

† At 100 PSIG inlet pressure with full pressure drop.

Most popular.



For inventory, lead time, and kit lookup, visit www.pdnplu.com

EM Series – Sintered Bronze Muffler / Filters

Muffler / filters effectively reduce air exhaust noises to an industry accepted level with minimum flow restriction. They protect valves, impact wrenches, screw drivers and other air tools by preventing dirt and other foreign matter from entering the system. Non-corrosive. Can be cleaned with many common solvents.

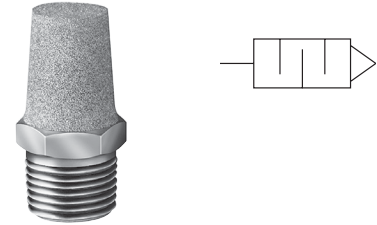

EM Series

Pipe thread	Overall length	Hex size	Part number
M5	.75	5/16"	EMM5
1/8"	1.00	7/16"	EM12
1/4"	1.32	9/16"	EM25
3/8"	1.54	11/16"	EM37
1/2"	1.85	7/8"	EM50
3/4"	2.29	1-1/6"	EM75
1"	2.91	1-5/16"	EM100
1-1/4"	3.25	1-11/16"	EM125
1-1/2"	3.69	2"	EM150

Operating information

Operating pressure: 250 PSIG (Air)
Cracking pressure 1 to 2 PSIG

Operating temperature:* 0°F to 300°F

* Ambient temperatures below freezing require moisture-free air. Ambient temperatures below freezing and above 180° require lubricants especially selected for suitability at these temperatures. Pneumatic valves should be used with filtered and lubricated air.

Muffler / Flow Controls

Muffler / flow controls provide an acceptable exhaust noise level and effectively meter exhaust. Installed in valve exhaust ports, they control cylinder piston speeds throughout a wide range. The adjusting screw cannot be accidentally blown out, can be locked to maintain setting. Brass and bronze construction. Clean with commonly used solvents.

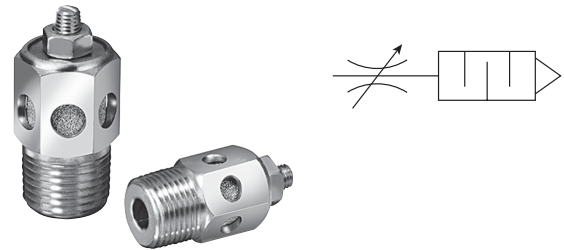

Muffler / Flow Controls

Pipe thread	Overall length	Hex size	Part number
1/8"	1.15	9/16"	045020002
1/4"	1.42	1/2"	045040004
3/8"	1.49	11/16"	045060060
1/2"	1.77	7/8"	045080080
3/4"	1.98	1-1/16"	045120012
1"	2.15	1-5/16"	045160016

Operating information

Operating pressure: 250 PSIG (Air)
Cracking pressure 1 to 2 PSIG

Operating temperature:* 0°F to 300°F

* Ambient temperatures below freezing require moisture-free air. Ambient temperatures below freezing and above 180° require lubricants especially selected for suitability at these temperatures. Pneumatic valves should be used with filtered and lubricated air.

 Most popular.



For inventory, lead times, and kit lookup, visit www.pdnplu.com

Breather Vents

These low silhouette versions of the muffler / filter are useful where space is a problem and / or to prevent contamination. Use for vacuum relief or pressure equalization in gear boxes, oil tanks, reservoirs, etc. Non-corrosive.



Breather Vent

Pipe thread	Overall length	Hex size	Part number
1/8"	0.44	7/16"	047020002
1/4"	0.63	9/16"	047040004
3/8"	0.75	11/16"	047060006
1/2"	0.88	7/8"	047080008
3/4"	1.00	1-1/6"	047120012
1"	1.31	1-5/16"	047160016
1-1/4"	1.41	1-11/16"	047200020
1-1/2"	1.50	2"	047240024

NOTE: Breather vents should not be used as exhaust mufflers.

Operating information

Operating pressure: 150 PSIG (Air) max.

Operating temperature:* 0°F to 300°F

* Ambient temperatures below freezing require moisture-free air. Ambient temperatures below freezing and above 180° require lubricants especially selected for suitability at these temperatures. Pneumatic valves should be used with filtered and lubricated air.

ES Series – Silencer

The silencer is designed to give superior performance in noise control with a minimum effect on air efficiency. "Trimline" design allows location in the tightest places without extra plumbing and fittings. Fits directly into the exhaust port of more than 90% of present commercial valves. Slotted body permits rapid discharge of air without undesirable back pressure. Unique nylon screen element resists dirt buildup or clogging.

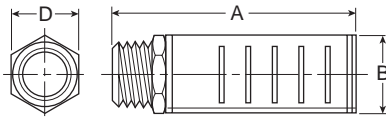

Operating information

Operating pressure: 250 PSIG (Air) max.

Operating temperature:* 0°F to 300°F

* Ambient temperatures below freezing require moisture-free air. Ambient temperatures below freezing and above 180° require lubricants especially selected for suitability at these temperatures. Pneumatic valves should be used with filtered and lubricated air.

ES Series – Silencer

Pipe thread	Flow SCFM @ 100 PSIG inlet	Dimensions			Part numbers	
		A	B	D	NPTF	BSPT (R)
1/8"	115	1.85	0.81	0.63	ES12MC	ESB12MC
1/4"	129	1.85	0.81	0.63	ES25MC	ESB25MC
3/8"	219	3.31	1.26	1.00	ES37MC	ESB37MC
1/2"	549	3.31	1.26	1.00	ES50MC	ESB50MC
3/4"	893	4.56	2.01	1.62	ES75MC	ESB75MC
1"	1,013	4.56	2.01	1.62	ES100MC	ESB100MC
1-1/4"	1,486	5.69	2.88	—	ES125MC	ESB125MC
1-1/2"	1,580	5.69	2.88	—	ES150MC	ESB150MC

Most popular.



For inventory, lead time, and kit lookup, visit www.pdnplu.com

Stainless Steel Mufflers

Corrosion resistant mufflers for harsh environments

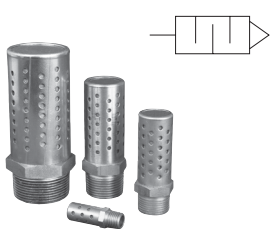

Port size	Construction	Threads	Dimensions In. (mm)		Part number
			Width	Length	
1/4	Stainless steel	Male, NPT	0.56 (14.2)	1.75 (44.5)	5500A2004
1/2	Stainless steel	Male, NPT	0.87 (22.1)	2.75 (69.7)	5500A4004
1	Stainless steel	Male, NPT	1.31 (33.3)	3.87 (98.3)	5500A6004
2	Nickel plated	Male, NPT	2.37 (60.2)	5.50 (139.7)	5500A9004*

* Nickel plated

Flow Controls
& Check Valves

Misc
Accessories

Integrated
Fittings

Accessories



ASN Air Line Silencer, Plastic

- Compact
- Lightweight
- Easy to Install
- Excellent Noise Reduction
- Protects Components from Contamination
- NPT and BSPT Threads Available

The plastic silencer is designed to give excellent noise reduction with a minimum effect on air efficiency. The "Trimline" design allows for locating the silencer in the tightest places without extra plumbing or fittings. Fits directly into the exhaust port of most commercial valves. Open surface area of element allows for rapid discharge of air without undesirable back pressure.

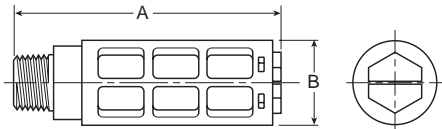

Operating information

Operating pressure:	0 to 150 PSIG (0 to 10 bar, 0 to 1034 kPa)
Operating temperature:	14°F to 140°F (-10°C to 60°C)

Material Specifications

Body	Acetal (Plastic)
Element	Polyethylene

ASN Air Line Silencer, Plastic

Thread size	A (mm)	B (mm)	Maximum flow (SCFM) 100 PSIG inlet	Sound pressure level (dBA)		Part number	
				20 PSIG inlet	100 PSIG inlet	NPT	BSPT
M5	0.43 (11)	0.32 (8)	15	69	79	AS-5	
1/8"	1.57 (40)	0.63 (16)	51	69	81	ASN-6	AS-6
1/4"	2.56 (65)	0.83 (21)	124	67	84	ASN-8	AS-8
3/8"	3.35 (85)	0.98 (25)	247	83	98	ASN-10	AS-10
1/2"	3.74 (95)	1.18 (30)	370	69	96	ASN-15	AS-15

 Most popular.



For inventory, lead time, and kit lookup, visit www.pdnplu.com

P6M G Thread Air Line Silencer, Plastic

- All Plastic Ultra Light Weight Versions
- High Noise Level Reduction
- Low Back Pressure Generation

The plastic silencer is designed to give excellent noise reduction with a minimum effect on air efficiency. The “Trimline” design allows for locating the silencer in the tightest places without extra plumbing or fittings. Fits directly into the exhaust port of most commercial valves. Open surface area of element allows for rapid discharge of air without undesirable back pressure.

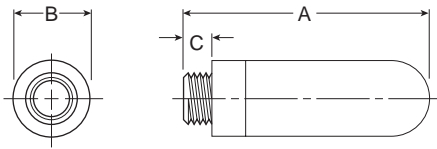
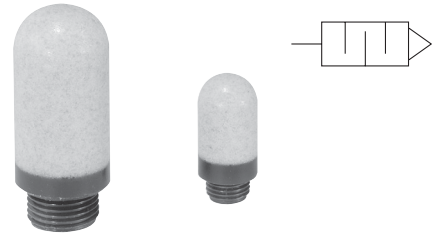

Operating information

Operating pressure:	0 to 246 PSIG (0 to 17 bar, 0 to 1700 kPa)
Operating temperature:	Plastic: 14°F to 176°F (-10°C to 80°C) Metal: 14°F to 165°F (-10°C to 74°C)
Efficiency	92%

P6M G Thread, Air Line Silencer, Plastic

Port thread	A	Diameter B	C	Weight (grams)	Part number
M5	0.91 (23)	0.26 (6,5)	0.16 (4)	0.01	P6M-PAC5
G1/8	1.14 (29)	0.55 (14)	0.24 (6)	0.02	P6M-PAB1
G1/4	1.34 (34)	0.67 (17)	0.24 (6)	0.04	P6M-PAB2
G3/8	2.36 (60)	0.98 (25)	0.35 (9)	0.06	P6M-PAB3
G1/2	2.52 (64)	0.98 (25)	0.43 (11)	0.10	P6M-PAB4
G3/4	5.51 (140)	1.50 (38)	0.55 (14)	0.50	P6M-PAB6
G1	6.30 (160)	1.89 (48)	0.79 (20)	0.62	P6M-PAB8

Most popular.



For inventory, lead times, and kit lookup, visit www.pdnplu.com

Flow Controls
& Check Valves

Misc
Accessories

Integrated
Fittings

Accessories



ECS Reclassifier, Air Line Muffler

The ECS (Muffler-Reclassifier) eliminates unwanted oil mist and reduces exhaust noise from pneumatic valves, cylinders and air motors.

- 99.97% Oil Removal Efficiencies
- 25 dBA Noise Attenuation
- 1/2" NPT and 1" NPT
- Disposable Units
- Continuous or Plugged Drain Option
- Metal Retained Construction
- Fast Exhaust Time

Improve Overall Plant Environment

Exhaust oil mist and noise pollution have a direct impact on worker productivity.

Oil aerosol mist from lubricators and compressors is pervasive and enters the industrial plant environment through the exhaust ports of valves, cylinders and air motors. This rapidly expanding exhaust also produces sudden and excessive noise.

The ECS (Muffler-Reclassifier) is 99.97% efficient at removing the oil aerosols. The ECS also acts as a silencer to lower the dBA levels below O.S.H.A. requirements.

The result is a cleaner, quieter environment which equates to greater work productivity and safety.

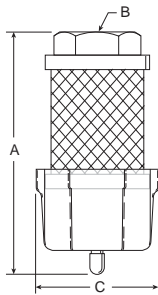

ECS Reclassifier, Air Line Muffler

Thread size	A	B	C	Part number
1/2	5.30 (135 mm)	1/2" NPT	2.57 (65 mm)	ECS3
1	7.30 (185mm)	1" NPT	2.57 (65mm)	ECS5

Performance Characteristics

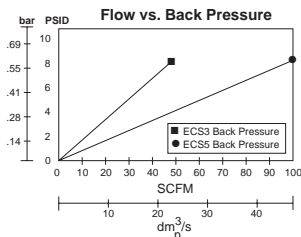
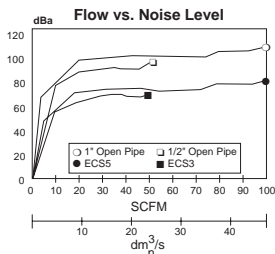

Most popular.



Operating information

Maximum line pressure:	100 PSIG (6.8 bar)
Maximum operating temperature:	125°F (52°C)

Operation

Compressor oils and lubricating oils are exhausted from valves, cylinders and air motors into the ECS. Oil aerosols are “coalesced” into larger droplets and gravity pulls them into the attached drain sump. The sump can then be drained manually or by using a 1/4" ID plastic tube drain. The air flowing into the ECS is also muffled or silenced as it enters the inside of the ECS and passes through the filter media into the atmosphere.

Proven Technology

The ECS units are constructed from the same materials that go into our oil removal coalescing filter elements.

The seamless design insures media uniformity and strength. This proven technology provides high coalescing efficiency with low pressure drop.

The filter media is supported by cylindrical perforated steel retainers both inside and out. These retainers, fully plated for excellent corrosion resistance, give the ECS units high rupture strength in either flow direction. These filters can also be used as high efficiency inlet or bypass filters for vacuum pumps, or breather elements to protect the air above critical process liquids.

ECS3 / ECS5

The ECS solves two problems inherent in compressed air exhaust from valves, cylinders and air motors - oil mist removal and noise abatement.

The ECS will improve your industrial plant environment, thereby improving worker productivity.

Flow Controls
& Check Valves

Misc
Accessories

Integrated
Fittings

Accessories



OR Series Quick Exhaust & Shuttle Valves

Quick exhaust valves provide rapid exhaust of control air when placed between control valve and actuator. They can also be used as shuttle valves. Diaphragm materials are available in urethane, Nitrile, Fluorocarbon, and PTFE to meet a wide variety of operating conditions.

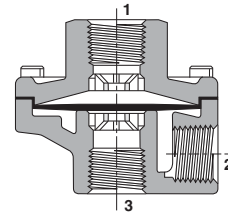

Material Specifications

Body	Die cast aluminum
Static Seals	Nitrile standard with urethane (Others see chart below)
Diaphragm	Standard – Urethane Optional – Fluorocarbon, PTFE, or Nitrile (Depending on size)

Operating information

Operating pressure (Air): 150 PSIG (max), 3 PSIG (min)
200 PSIG (max), 50 PSIG (min) for Model No. OR37TB (PTFE diaphragm)

Operating temperature:*

- Urethane: 0°F to 180°F (-18°C to 80°C)
- Nitrile: 0°F to 180°F (-18°C to 80°C)
- Fluorocarbon: 0°F to 400°F (-18°C to 205°C)
- PTFE: 0°F to 500°F (-18°C to 260°C)

* Ambient temperatures below freezing require moisture-free air. Ambient temperatures below freezing and above 180° require lubricants especially selected for suitability at these temperatures. Pneumatic valves should be used with filtered and lubricated air.

Mounting Bracket Kit – No. 036408100

(Including body screws)

For “OR12” and “OR25” sizes with 7/8” “A” Dimension.

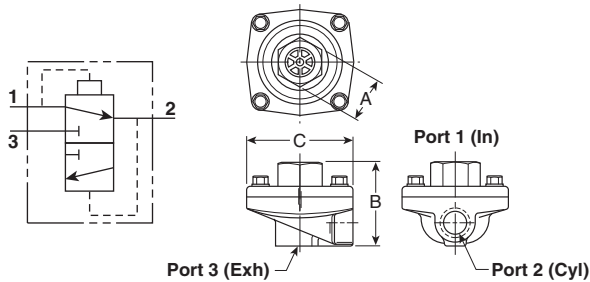
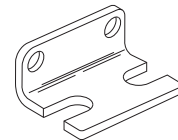

Model Selection, Performance Data and Dimensions

Port 1	Port 2	Port 3	Flow (SCFM †)	Part Number		A	B	C	Service Kit No.
				NPTF	BSPP “G”				
STANDARD Urethane diaphragms (Nitrile static seals)									
1/4"	1/4"	3/8"	150	OR25NB	ORB25NB	1" Hex	2.06	2.44	033400105
	3/8"	3/8"	240	OR25PB	—	1" Hex	2.06	2.44	033400105
3/8"	3/8"	3/8"	240	OR37B	ORB37B	1" Hex	2.06	2.44	033400105
1/2"	1/2"	1/2"	450	OR50B	ORB50B	1-1/2" Hex	2.88	3.38	034750109
3/4"	3/4"	3/4"	550	OR75B	ORB75B	1-1/2" Hex	2.88	3.38	034750109
Nitrile diaphragms (Nitrile static seals)									
1/8"	1/8"	1/8"	70	OR12B	ORB12B	7/8" Sq.	1.75	1.88	033400105
	1/8"	1/4"	70	OR12NB	ORB12NB	7/8" Sq.	1.75	1.88	033400105
1/4"	1/4"	1/4"	90	OR25B	ORB25B	7/8" Sq.	1.75	1.88	036408000
	1/4"	3/8"	90	OR25NFB	ORB25NFB	1" Hex	2.06	2.44	033408000
3/8"	3/8"	3/8"	240	OR37FB	ORB37FB	1" Hex	2.06	2.44	033408000
3/4"	3/4"	3/4"	550	OR75FB	ORB75FB	1-1/2" Hex	2.88	3.38	034759000
Fluorocarbon diaphragms for extended temperature operation (Fluorocarbon static seals)									
1/8"	1/8"	1/8"	70	OR12VB	ORB12VB	7/8" Sq.	1.75	1.88	036508000
	1/8"	1/4"	70	OR12NVB	ORB12NVB	7/8" Sq.	1.75	1.88	036508000
1/4"	1/4"	1/4"	90	OR25VB	ORB25VB	7/8" Sq.	1.75	1.88	036508000
3/8"	3/8"	3/8"	240	OR37VB	ORB37VB	1" Hex	2.06	2.44	033400319
1/2"	1/2"	1/2"	450	OR50VB	ORB50VB	1-1/2" Hex	2.88	3.38	034750120
3/4"	3/4"	3/4"	550	OR75VB	ORB75VB	1-1/2" Hex	2.88	3.38	034750120
PTFE diaphragms for higher pressure and temperature (Fibre static seals)									
3/8"	3/8"	3/8"	240	OR37TB	ORB37TB	1" Hex	2.06	2.44	033400504

† At 100 PSIG inlet pressure with full pressure drop.

Most popular.



For inventory, lead times, and kit lookup, visit www.pdnplu.com

Shuttle Valves

Shuttle valves determine a single pneumatic output from two separate inputs. If pressure is applied to both ports simultaneously, the valve will select the port with the higher pressure.



Material Specifications

Body	Aluminum
Internal Components	Aluminum
Seals	Nitrile

Operating information

Operating pressure:
 Maximum: 200 PSIG
 Minimum: Differential Pressure 3 PSIG

Operating temperature:* 0°F to 160°F

* Ambient temperatures below freezing require moisture-free air. Ambient temperatures below freezing and above 180° require lubricants especially selected for suitability at these temperatures. Pneumatic valves should be used with filtered and lubricated air.

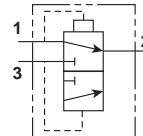
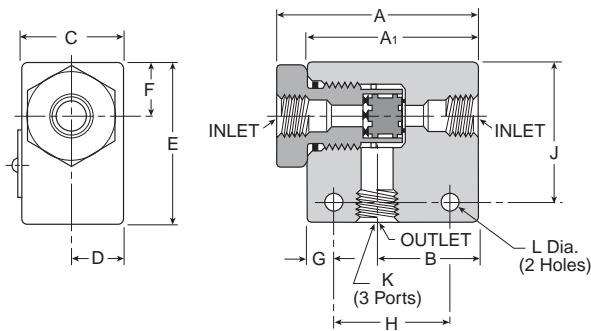

Model Selection and Dimensions

Port size	Flow (Cv)	Dimensions											Part number	
		A	A1	B	C	D	E	F	G	H	J	K		L
1/8"	0.32	N/A	1.62	0.81	0.62	0.31	1.00	0.281	0.312	1.00	0.75	1/8 - 27	0.219	N1641001
1/4"	1.65	2.50	2.12	1.25	1.25	0.62	2.00	0.67	0.265	1.25	1.35	1/4 - 18	0.219	N1642003
3/8"	2.02	2.50	2.12	1.25	1.25	0.62	2.00	0.67	0.265	1.25	1.35	3/8 - 16	0.219	N1643003

Most popular.



For inventory, lead time, and kit lookup, visit www.pdnplu.com



Typical “Quick Exhaust Valve” Applications

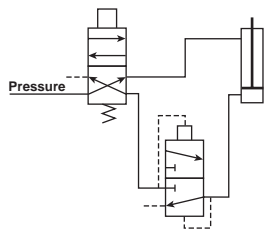

Rapid Retraction – Double Acting Cylinder

In this circuit, air is exhausted through a Quick Exhaust Valve that is **close coupled** to the cap end of the cylinder. Because the Quick Exhaust Valve has a greater exhaust capacity than the four-way Control Valve, increased cylinder speed can be accomplished with a smaller and less expensive control valve.

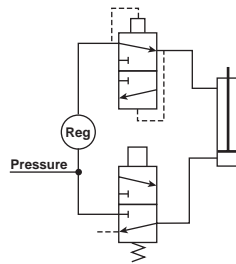

Dual Pressure Actuation of Double Acting Cylinder

This circuit utilizes a Quick Exhaust Valve and a three-way Control Valve to permit rapid extension of the cylinder at a high pressure.

NOTE: Line pressure must be 3 or 4 times greater than rod end pressure. Effective working pressure is the differential between the cap and rod end.

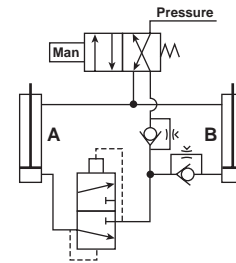

Bi-Directional Control of Two Double Acting Cylinders

This circuit provides maximum control with a minimum of valving. A large four-way Control Valve is not needed to permit the rapid retraction of Cylinder A, as the Quick Exhaust Valve performs this function. The extension of Cylinders A and B and retraction of Cylinder B are controlled by Speed Control Valves.

Flow Controls & Check Valves

Misc Accessories

Integrated Fittings

Typical “Shuttle Valve” Applications

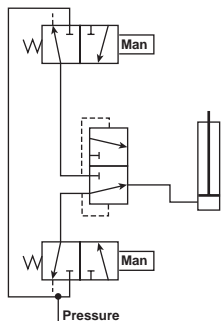

“OR” Circuit

The most common application of the Shuttle Valve is the “OR” Circuit. Here a cylinder or other work device can be actuated by either control valve. The valves can be manually or electrically actuated and located in any position.

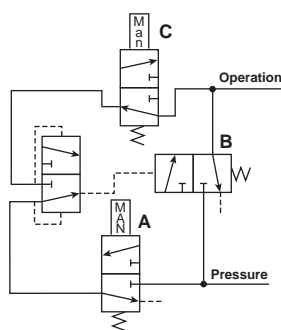

Memory Circuit

This circuit enables continuous operation once initiated. Pressure is delivered to the circuit when Valve A is actuated. This allows pressure to pass through the shuttle valve actuating Valve B. Pressure then flows through Valve B and also the other side of the shuttle valve which holds Valve B open for continuous operation. To unlock the circuit, Valve C must be opened to exhaust the circuit and allow Valve B to return to its normally closed position.

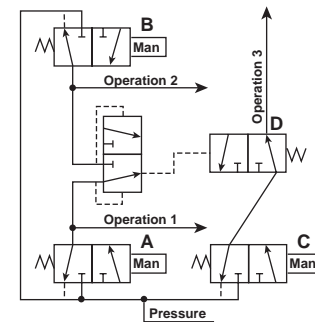

Interlock

This circuit prevents the occurrence of a specific operation while one or another operation takes place. When either Valve A or B is actuated to perform operation 1 or 2, Valve D is shifted to the closed position and prevents operation 3 from occurring.

Accessories



Blocking Valves

The blocking valve is a single acting spring return 2/2 valve in a fitting format. The device requires a pneumatic pilot signal to open, which allows free flow of air or neutral gas. As long as a pilot signal is present, the device will remain open. When the pilot signal is removed, the internal spring will close the blocking valve, bubble tight.

These devices have two primary design uses: (1) to prevent unwanted gravity induced motion in cylinders during shut down procedures or during periods of lost supply pressure and (2) freezing the cylinder position by using a blocking valve at each end of the cylinder. Application needs such as tool or work piece protection, horizontal indexing or inspection stops are often satisfied by these devices.

Material specifications

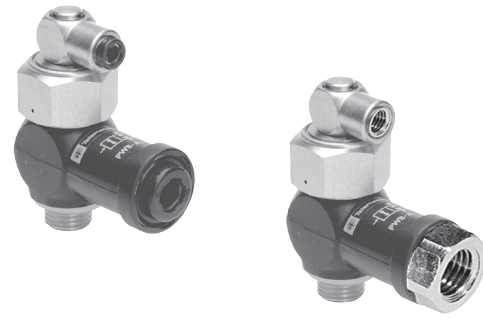

Body Zinc alloy





Operating information

Operating pressure: 0 to 150 PSIG (0 to 10.3 bar)
 Operating temperature:
 Operating 5°F to 140°F (-15°C to 60°C)
 Storage -40°F to 160°F (-40°C to 70°C)

For Cylinder Mounting (Can also be mounted in Threshold Sensor Banjo) With Instant Tube Fittings

BSPP				NPT				
Symbol	Connection for pilot	Cylinder port thread (male)	Connection for tube	Part number	Connection for pilot	Cylinder port thread (male)	Connection for tube	Part number
  4mm Tube PWBA3469		1/8"	6mm	PWBA1468	5/32" Tube	1/8"	1/4"	PWBA3468
		1/4"	6mm	PWBA1469		1/4"	1/4"	PWBA3469
		1/4"	8mm	PWBA1489		3/8"	3/8"	PWBA3493
		3/8"	8mm	PWBA1483		1/2"	1/2"	PWBA3412
		3/8"	10mm	PWBA1493				
		1/2"	12mm	PWBA1412				

With Threaded Connections and Tube Pilot Port

BSPP				NPT				
Symbol	Connection for pilot	Cylinder port thread (male)	Connection from valve (female)	Part number	Connection for pilot	Cylinder port thread (male)	Connection from valve (female)	Part number
  4mm Tube M5 Female PWBA3833		1/8"	1/4"	PWBA1898	5/32" * Tube	1/8"	1/8"	PWBA3888
		1/4"	1/4"	PWBA1899		1/4"	1/4"	PWBA3899
		3/8"	3/8"	PWBA1833		3/8"	3/8"	PWBA3833
		1/2"	1/2"	PWBA1822		1/2"	1/2"	PWBA3822

* Instant fitting

With Threaded Connections and Threaded Pilot Port

NPT			
Connection for pilot	Cylinder port thread (male)	Connection from valve	Part number
1/8" pipe	1/8"	1/8"	PWBA38887
	1/4"	1/4"	PWBA38997
	3/8"	3/8"	PWBA38337
	1/2"	1/2"	PWBA38227

 Most popular.



For inventory, lead time, and kit lookup, visit www.pdnplu.com

Flow Controls
 & Check Valves
 Misc
 Accessories
 Integrated
 Fittings
 Accessories

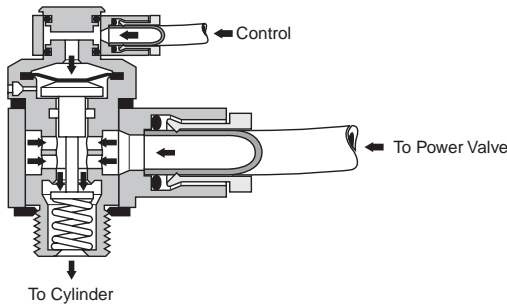
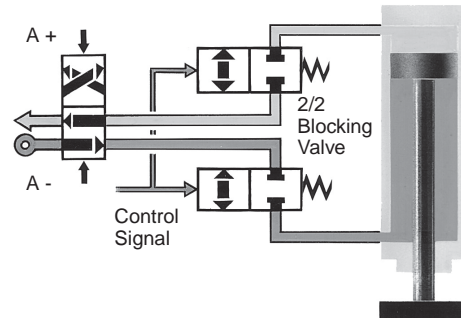
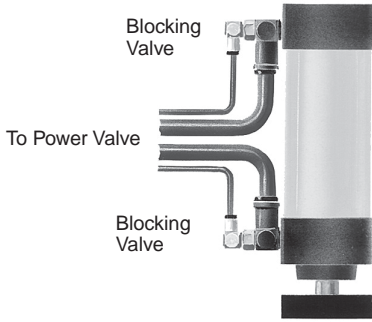

PWBA General Characteristics

Permissible Fluids	Air or neutral gas, 50 µm filtration, lubricated or not
Mechanical Life	10 Million
Maximum Operating Frequency	10Hz
Mounting Screw	Brass
Maximum Mounting Torque:	88 inch pounds
10-32 UNF and M5	
1/8"	70 inch pounds
1/4"	105 inch pounds
3/8"	265 inch pounds
1/2"	310 inch pounds
Adjustment	N/A
Adjustment Locking	N/A
Air Quality – Standard Shop Air, Lubricated or Dry 40 µm Filtration	

Piloting and De-Piloting Pressure

Blocking Valve Sizes	Pilot with Operating Pressure of:			
	30 PSI	60 PSI	90 PSI	120 PSI
1/8" BSP or NPT	33 PSI	40 PSI	45 PSI	50 PSI
1/4" BSP or NPT	33 PSI	40 PSI	45 PSI	50 PSI
3/8" BSP or NPT	35 PSI	40 PSI	45 PSI	50 PSI
1/2" BSP or NPT	45 PSI	50 PSI	55 PSI	60 PSI

Blocking Valve Sizes	Depilot with Operating Pressure of:			
	30 PSI	60 PSI	90 PSI	120 PSI
1/8" BSP or NPT	20 PSI	25 PSI	30 PSI	34 PSI
1/4" BSP or NPT	20 PSI	25 PSI	30 PSI	34 PSI
3/8" BSP or NPT	20 PSI	25 PSI	30 PSI	34 PSI
1/2" BSP or NPT	25 PSI	30 PSI	34 PSI	40 PSI



For inventory, lead times, and kit lookup, visit www.pdnplu.com

Threshold Sensors

The plug-in threshold sensors provide feedback information on pneumatic cylinder status in either pneumatic or electrical outputs. Mounted into the cylinder port, these devices monitor the back pressure of the cylinder's exhaust. When the cylinder's piston stops, the back pressure rapidly drops and the threshold sensor provides the desired output. Ideal for variable stroke applications such as robotics where other sensor type devices such as limit switches are impractical, these devices provide a signal whenever the cylinder stops motion.

The threshold sensor consists of two complementary sub assemblies (1) the banjo fitting and (2) the plug-in sensor element. In all cases, the sensor is easily plugged into the banjo fitting and locked in place with a spring clip. The banjo fitting is designed to accept (piggy backed) other functional fittings such as flow controls or blocking valves. Simply select the sensor based on the type feedback signal that best fits the application.

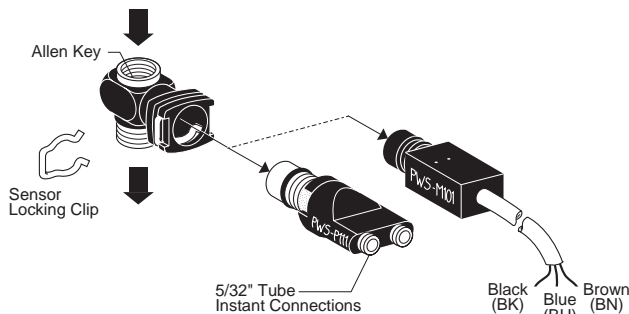

Material specifications

Body	Thermoplastic
Mounting screw	Brass

Banjo Sockets (with Sensor Clip)

Port size	Wrench	Part number
10-32	5/16" Hex	PWSB1557
1/8"	3/16" Allen	PWSB1887
1/4"	5/16" Allen	PWSB1997
3/8"	3/8" Allen	PWSB1337
1/2"	1/2" Allen	PWSB1227

Plug-in Sensors

Output	Connection	Part number
Pneumatic	5/32" push-in	PWSP111
Electrical	3-wire cable (6 ft)	PWSM1012

Most popular.



Operating information

Operating pressure: 0 to 150 PSIG (0 to 10.3 bar)
 Operating temperature:
 Operating 5°F to 140°F (-15°C to 60°C)
 Storage -40°F to 160°F (-40°C to 70°C)

⚠ Caution: If it is possible that the ambient temperature may fall below freezing, the medium must be moisture free to prevent internal damage or unpredictable behavior.

Mounting

Banjo fittings in 10-32 to 1/2" pipe sizes are designed to be installed directly into actuator ports (up to 5" bore cylinders). The banjo fitting can accommodate other functional fittings and components such as right angle flow control valves or blocking valves. Banjo fittings screw into actuators using an Allen wrench or 5/16" hex head wrench for 10-32 size. Electrical or pneumatic feedback element snaps into place using a locking clip.

Operation

Pneumatic sensors have a continuous pressure signal applied to the sensor device. Electrical sensors have a continuous electrical signal applied to the sensor device. The threshold sensor assembly mounted directly into the cylinder Port provides an output signal S, which can be pneumatic or electrical, when the falling back pressure in the exhausting chamber of the cylinder reaches the operating threshold (approximately 6-9 PSIG). (The device is a normally passing device. The output is only on when there is nearly zero pressure at the cylinder.)

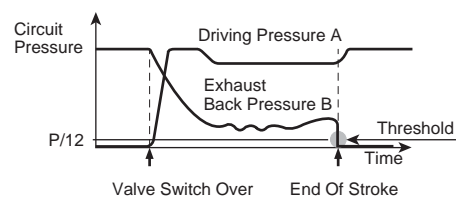

Flow Controls & Check Valves

Misc Accessories

Integrated Fittings

Accessories



For inventory, lead time, and kit lookup, visit www.pdnplu.com

Specifications

Maximum Operating Frequency	10 Hz
Pilot Pressure (PWSP111)	>64 PSIG (4.4 bar)
Threshold Pressure	6 to 9 PSIG (.4 to .6 bar)
Output Flow Rate (PWSP111)	3 SCFM at 90 PSIG
Current Rating (PWSM1012) –	5 VA, 250 VAC 5W, 48 VAC
Life Expectancy –	10 million cycles with dry air at 90 PSIG, 68°F, and 1 Hz operating frequency
Voltage Range (PWSM1012) –	12 - 240 VAC 12 - 48 VDC

Air Quality – Standard Shop Air, Lubricated or Dry 40 µm Filtration

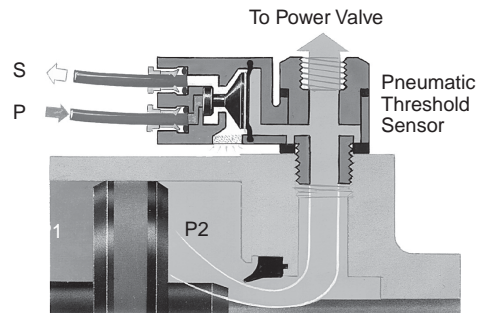
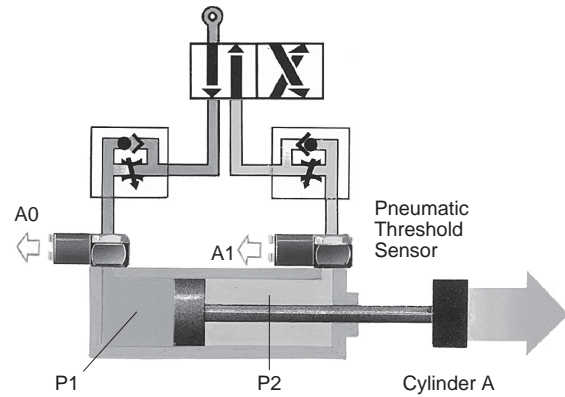
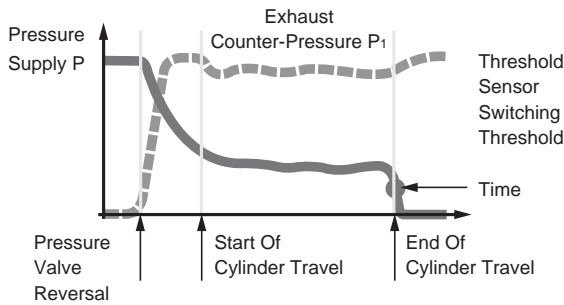

PWS General Characteristics

Permissible Fluids	Air or neutral gas, 50 µm filtration, lubricated or not
Flow	N/A
Mechanical Life	10 Million
Maximum Operating Frequency	10Hz
Maximum Mounting Torque:	
10-32 UNF and M5	88 inch pounds
1/8"	70 inch pounds
1/4"	105 inch pounds
3/8"	265 inch pounds
1/2"	310 inch pounds
Adjustment	N/A
Adjustment Locking	N/A

Piloting and De-Piloting Pressure

Threshold sensors	Pilot with operating pressure of 90 PSI	Depilot with operating pressure of 90 PSI
PWSP111	64 PSI	6 PSI
PWSM1012	15 PSI	9 PSI
PWSE101 and PWSE111	10 PSI	7 PSI

Flow Controls & Check Valves

Misc Accessories

Integrated Fittings

Accessories



Fluid Power		Universal Description	Electrical	
Function	Symbol		Function	Symbol
Normally Closed (N.C.)	2-Way	Normally Non-Passing (NNP)	Normally Open (N.O.)	
	3-Way			
Normally Open (N.O.)	2-Way	Normally Passing (NP)	Normally Closed (N.C.)	
	3-Way			



For inventory, lead times, and kit lookup, visit www.pdnplu.com

Blocking Valves

PWBA14/34

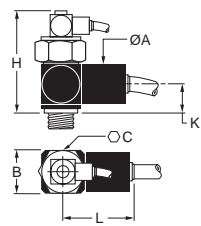

ØA	B	C	K	H	L	Flow*	Part number
0.86" (22)	0.82" (21)	0.94" (24)	0.53" (13.5)	2.32" (59)	1.54" (39)	14.8	PWBA1468/3468
0.86" (22)	0.82" (21)	0.94" (24)	0.53" (13.5)	2.09" (53)	1.54" (39)	19.4	PWBA1469/3469 PWBA1489
1.06" (27)	1.10" (28)	0.94" (24)	0.55" (14)	2.09" (53)	1.98" (50)	45.9	PWBA1483 PWBA1493/3493
1.22" (31)	1.30" (33)	1.30" (33)	0.94" (24)	2.59" (66)	2.59" (66)	81.2	PWBA1412/3412

PWBA18/38

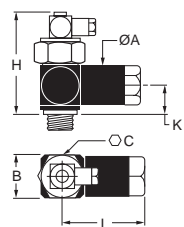

0.86" (22)	0.82" (21)	0.94" (24)	0.53" (13.5)	2.32" (59)	1.71" (43.5)	14.8	PWBA1898/3888
0.86" (22)	0.82" (21)	0.94" (24)	0.53" (13.5)	2.09" (53)	1.71" (43.5)	19.4	PWBA1899/3899
1.06" (27)	1.10" (28)	0.94" (24)	0.55" (14)	2.09" (53)	2.18" (55)	45.9	PWBA1833/3833
1.22" (31)	1.30" (33)	1.30" (33)	0.94" (24)	2.59" (66)	2.47" (63)	81.2	PWBA1822/3822

PWBA38

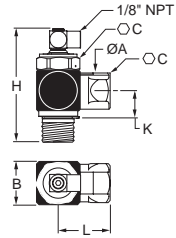

0.75" (19)	0.87" (22)	0.83" (21)	0.67" (17)	2.20" (56)	1.73" (44)	14.8	PWBA38887
0.75" (19)	0.87" (22)	0.83" (21)	0.67" (17)	2.20" (56)	1.73" (44)	19.4	PWBA38997
1.06" (27)	1.18" (30)	1.06" (27)	0.91" (23)	2.64" (67)	1.42" (36)	45.9	PWBA38337
1.06" (27)	1.18" (30)	1.06" (27)	0.91" (23)	2.64" (67)	1.42" (36)	81.2	PWBA38227

Threshold Sensors

Banjo Socket

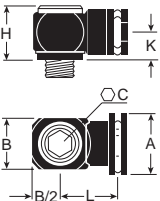

A	B	C	H	K	L	Part number
.98 (25)	.43 (11)	5/16" Hex	.79 (20)	.40 (10)	.67 (17)	PWSB1557
.98 (25)	.63 (16)	3/16" Allen	.71 (18)	.40 (10)	.79 (20)	PWSB1887
.98 (25)	.83 (21)	5/16" Allen	.71 (18)	.40 (10)	.87 (22)	PWSB1997
.98 (25)	1.10 (28)	3/8" Allen	.79 (20)	.47 (12)	.98 (25)	PWSB1337
.98 (25)	1.30 (33)	1/2" Allen	.93 (24)	.55 (14)	1.02 (26)	PWSB1227

PWSP111

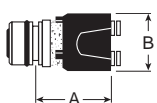

A	B	Part number
.87 (22)	.79 (20)	PWSP111
1.26 (32)	.79 (20)	PWSM1012

PWSM1012



Flow Controls
& Check Valves

Misc
Accessories

Integrated
Fittings

Accessories



Tank Valves

For tanks, steel barrels, compressors and other pneumatic containers where a dependable automatic air valve is needed. Equipped with standard valve core and sealing cap. Maximum operating pressure is 185 PSIG. Temperature range is -40°F to 220°F.

091660060, 1/8" pipe thread, dome shaped cap

Has a 1/8" pipe thread at bottom for minimum protrusion. N/P finish, dome shaped cap.

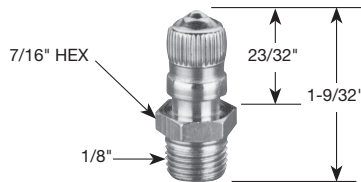

Thread size	Box qty	Part number
1/8	25	091660060

014680006, 1/8" pipe thread part way up the stem, screwdriver type cap

Has a 1/8" pipe thread part way up the stem which allows for minimum protrusion. N/P finish, has screwdriver type cap.

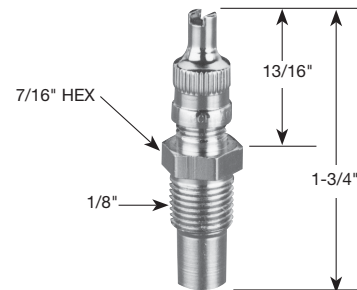

Thread size	Box qty	Part number
1/8	25	014680006

006450060, 1/8" pipe thread at bottom, screwdriver type cap

A 1/8" pipe thread at bottom permits maximum protrusion. N/P finish, screwdriver type cap.

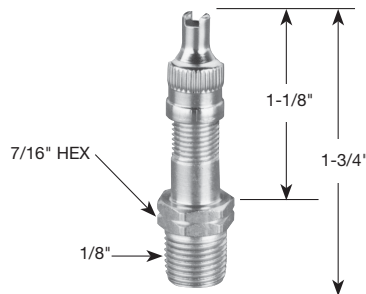

Thread size	Box qty	Part number
1/8	25	006450060

Most popular.



For inventory, lead times, and kit lookup, visit www.pdnplu.com

O.S.H.A. Certification — All safety blow guns conform to the requirements of Compressed Air Standards as currently described in the U.S. Bureau of Labor Standards, paragraph 1910.242, when pressurized at the inlet to a maximum of 100 PSIG. Conform to current O.S.H.A. Directive No. 100-1.

Brass Nozzle Blow Guns

Contoured lever or button control both provide a natural, comfortable grip even when used with gloves. Finger guard and hang-up hook for finger protection and quick safe storage. Die cast zinc body, painted finish.

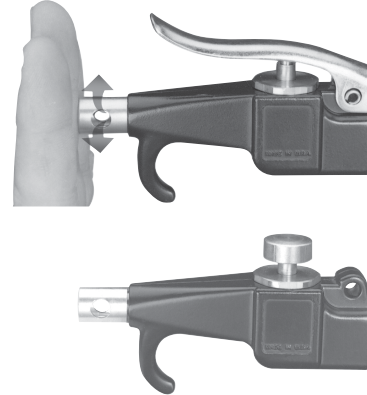

Brass Nozzle Blow Gun

Type	Inlet port	SCFM rating*	Part number
Lever operated	1/4	20	004750010
Button operated	1/4	20	004700010

* Based on 100 PSIG inlet pressure.

Flow Controls
& Check Valves

Misc
Accessories

Integrated
Fittings

Accessories



Vortec FLO-GAIN Blow Guns

A quiet Vortec FLO-GAIN nozzle is combined with a high performance blow gun. Compressed air attains sonic velocity through an adjustable slot and attaches to the exterior surface of the cone shaped nozzle. Settings are shown on a micrometer dial. Sound level of 80 dBA with 80 PSIG inlet. Finger guard and hang-up hook offers desirable finger protection and quick secure storage. Die cast zinc body, painted finish.

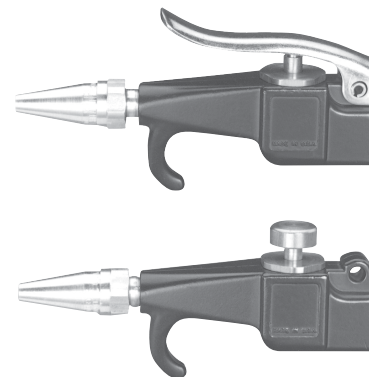

Vortec FLO-GAIN Blow Gun

Type	Inlet port	SCFM rating*	Part number
Lever operated	1/4	70+	004750900
Button operated	1/4	70+	004700900

* Based on 100 PSIG inlet pressure.

Self-Regulating Blow Gun

Designed with integral self-regulating pressure reducing valve for automatic shut-off when nozzle is blocked. Prevents air pressure buildup over 30 PSIG in compliance with U.S. Dept. of Labor standards.

Air shield aids in protecting the operator against blow back of flying chips of dirt. Designed to operate at less than 90 dBA to comply with government regulations. Die cast zinc body, painted finish.



Self-Regulating Blow Gun

Type	Inlet port	SCFM rating*	Part number
Lever operated	1/4	10	004750010

* Based on 100 PSIG inlet pressure.

 Most popular.

Performance Data

Inlet Pressure	Blocked Pressure	Sound Level
70 PSIG	17.0 PSIG	79 dBA
100 PSIG	21.0 PSIG	83 dBA
175 PSIG	28.0 PSIG	87 dBA



For inventory, lead time, and kit lookup, visit www.pdnplu.com

Brass Nozzle

004707020

General purpose nozzles are supplied as standard on 004700010 and 004750010 blow guns. Conform to the requirements of the Williams Steiger Occupational Safety and Health Act of 1970, paragraph 1910.242 when fitted with blow guns pressurized at the inlet to a maximum of 100 PSIG. Conform to O.S.H.A. Directive 100-1.

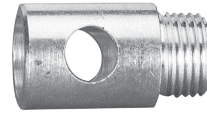

	Part number
Brass Nozzle	004707020

470 and 475 Series Blow Guns

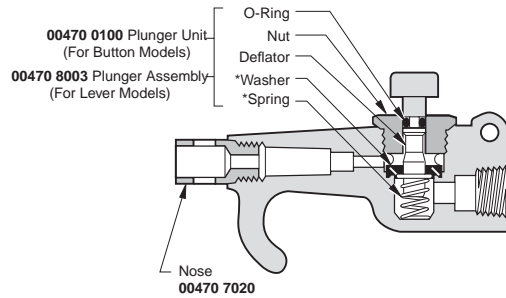

* Contained in Service Kit No. **00470 0090**

Flow Controls
& Check Valves

Misc
Accessories

Integrated
Fittings





























Accessories



Most popular.



For inventory, lead times, and kit lookup, visit www.pdnplu.com

Compact Flow Control Valves	FCC731 Meter Out  Page F27	FCC731 Meter Out - BSPP  Page F27	FCCB731 Bi-Directional Flow Control  Page F27	FCCB731 Bi-Directional Flow Control - BSPP  Page F27	FCCK731 Knobless Meter Out Flow Control  Page F28
	FCCK731 Knobless Flow Control - BSPP  Page F28	FCCKB731 Knobless Bi-Directional Flow Control - BSPP  Page F28	Miniature Flow Control Valves	FCM731 Meter Out Flow Control  Page F29	FCM731 Flow Control - BSPP  Page F29
FCMK731 Knobless Mini Meter Out Flow Control  Page F29	Swivel Outlet Flow Control Valves	FCCS731 Compact Swivel Outlet Flow Control  Page F30		FCMS731 Mini Swivel Outlet Flow Control  Page F30	FCMS731 Miniature Swivel Outlet - BSPP  Page F30
Plug-In Flow Control Valves		FCMSP731 Mini Flow Control  Page F31	FCMSP701 Miniature Flow Control  Page F31	FCCSP731 Compact Flow Control  Page F31	
	In-Line Flow Control Valves	FC832 Flow Control  Page F32	FCB832 Bi-Directional Flow Control  Page F32	FCPM832 Panel Mountable Flow Control  Page F33	FC836 Threaded Flow Control  Page F33
Compact Metal Flow Control Valves		FC705 Push-to-Connect Metal Flow Control  Page F34	FC701 Push-to-Connect Metal Flow Control - BSPP  Page F34	FC708 Threaded Port Meter Out Flow Control  Page F34	FC702 Threaded Port Metal Flow Control - BSPP  Page F34
	Flow Control Check Valves	32PLCK In-Line Check Valve  Page F35	W68PLCK Male Check Valve  Page F35	W68PLCKI Male Check Valve Meter In  Page F35	68PLCK Male Check Valve Meter Out - BSPP  Page F36
VC Check Valve  Page F36					









Flow Controls & Check Valves

Misc Accessories

Integrated Fittings

Accessories



Blocking Flow Control Valves	FC601 Push-to-Connect Lock Out Valves  Page F37	FC601 Push-to-Connect Lock-Out Valve - BSPP  Page F37	FC602 Threaded Port Lock Out Valves  Page F37	FC608 Threaded Port Lock-Out Valve - BSPP  Page F37	
	Threshold Sensor	PSBJ731 Pneumatic - 5/32 Pilot  Page F38	PSBJ731 Pneumatic - 4mm Pilot  Page F38	PSPJ731 Pneumatic - 10-32 Pilot  Page F38	PSBJ708 Pneumatic - M5 Pilot  Page F38

Flow Controls
& Check Valves

Misc
Accessories

Integrated
Fittings

Accessories



Compact Flow Control Valves

Compact flow control regulators ensure excellent performance of flow and are perfectly suited for reduced spaces due to their small size. The sensitivity of the adjustment screw provides very precise air flow control and regulation. A locking nut guarantees stability of adjustment against vibration tampering of the flow setting.



Material Specifications

Body (depending upon the model)	Glass reinforced nylon 6.6 Brass
Gripping Ring	Stainless Steel
Adjustment Screws	Nickel-plated brass
Locking Nut	Nickel-plated brass
Base	Nickel-plated brass

Applicable Tube

Tube O.D.	1/8, 5/32, 1/4, 3/8
Tube O.D. (mm)	4, 6, 8, 10, 12

Operating information

Pressure range:	15 to 145 PSI
Temperature range:	30°F to 160°F
Working fluid:	Compressed air

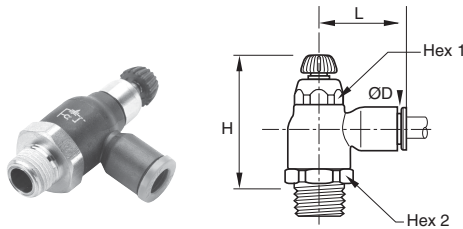

FCC731 Compact Meter Out - NPT

Tube size (In)	NPT	Hex 1 (In)	Hex 2 (In)	H Open	H Closed	L	Part number
5/32	1/8	0.63	0.39	1.67	1.44	0.85	FCC731-5/32-2
	1/4	0.63	0.39	1.67	1.44	0.85	FCC731-5/32-4
1/4	1/8	0.63	0.39	1.67	1.44	0.85	FCC731-4-2
	1/4	0.63	0.39	1.67	1.44	0.85	FCC731-4-4
3/8	1/4	0.91	0.67	2.03	1.71	1.22	FCC731-6-4
	3/8	0.91	0.67	2.03	1.71	1.22	FCC731-6-6

FC731 Compact Meter Out - BSPP

Tube size (mm)	BSPP	Hex 1 (mm)	Hex 2 (mm)	H Open	H Closed	L	Part number
4	1/8	10	16	38.0	44.0	22.0	FCC731-4M-2G
	1/8	10	16	38.0	44.0	22.0	FCC731-6M-2G
6	1/4	10	16	36.5	42.5	22.0	FCC731-6M-4G
	1/8	14	19	41.5	48.0	28.0	FCC731-8M-2G
8	1/4	14	19	41.5	48.0	28.0	FCC731-8M-4G
	3/8	14	19	41.5	48.0	28.0	FCC731-8M-6G
10	1/4	17	23	45.5	53.5	31.5	FCC731-10M-4G
	3/8	17	23	45.5	54.0	31.5	FCC731-10M-6G
12	3/8	17	23	45.5	54.0	35.0	FCC731-12M-6G
	1/2	17	24	45.5	54.0	35.0	FCC731-12M-8G

Most popular.

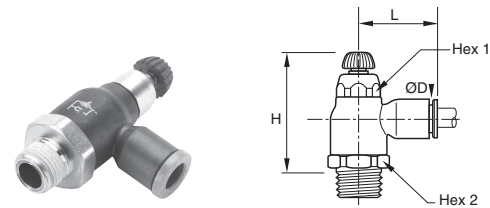

FCCB731 Compact Bi-Directional Flow Control - NPT

Tube size (In)	NPT	Hex 1 (In)	Hex 2 (In)	H Open	H Closed	L	Part number
5/32	1/8	0.63	0.39	1.67	1.44	0.85	FCCB731-5/32-2
	1/8	0.63	0.39	1.67	1.44	0.85	FCCB731-4-2
1/4	1/4	0.63	0.39	1.67	1.44	0.85	FCCB731-4-4

FCCB731 Compact Bi-Directional Flow Control - BSPP

Tube size (mm)	BSPP	Hex 1 (mm)	Hex 2 (mm)	H Open	H Closed	L	Part number
4	1/8	10	16	38.0	44.0	22.0	FCCB731-4M-2G
	1/8	10	16	38.0	44.0	22.0	FCCB731-6M-2G
6	1/4	10	16	36.5	42.5	22.0	FCCB731-6M-4G
	1/8	14	19	41.5	48.0	28.0	FCCB731-8M-2G
8	1/4	14	19	41.5	48.0	28.0	FCCB731-8M-4G
	3/8	14	19	41.5	48.0	28.0	FCCB731-8M-6G

Flow Controls & Check Valves

Misc Accessories

Integrated Fittings

Accessories



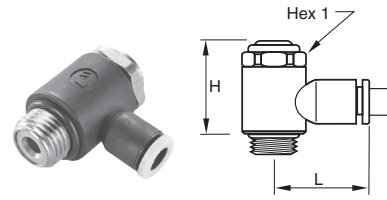
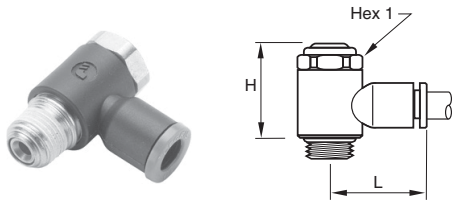

FCKC731 Knobless Meter Out Flow Control - NPT

Tube size (In)	NPT / UNF	Hex 1 (In)	H	L	Part number
1/8	10-32	10-32	-	0.69	FCKC731-2-0
	1/8	1/8	13	0.79	FCKC731-2-2
5/32	10-32	10-32	-	0.69	FCKC731-5/32-0
	1/8	1/8	13	0.79	FCKC731-5/32-2
1/4	10-32	10-32	-	0.69	FCKC731-4-0
	1/8	1/8	13	0.79	FCKC731-4-2
5/16	1/4	1/4	17	1.04	FCKC731-4-4
	1/8	1/8	13	0.79	FCKC731-5-2
3/8	1/4	1/4	17	1.04	FCKC731-5-4
	3/8	3/8	20	1.14	FCKC731-6-6

FCKCB731 Knobless Bi-Directional Flow Control - BSPP

Tube size (In)	BSPP / M5	Hex 1 (In)	H	L	Part number
4	M5X0.8	8	17.5	17.0	FCKCB731-4M-M5
	1/8	13	25.0	19.0	FCKCB731-4M-2G
6	M5X0.8	8	17.5	19.0	FCKCB731-6M-M5
	1/8	13	25.0	21.0	FCKCB731-6M-2G
8	1/4	17	26.5	22.0	FCKCB731-6M-4G
	1/8	13	25.0	26.0	FCKCB731-8M-2G
8	1/4	17	26.5	27.0	FCKCB731-8M-4G
	3/8	20	37.5	29.0	FCKCB731-8M-6G

FCKC731 Knobless Meter Out Flow Control - BSPP

Tube size (mm)	BSPP / M5	Hex 1 (mm)	H	L	Part number
4	M5X0.8	8.0	17.5	17.0	FCKC731-4M-M5
	1/8	13.0	25.0	19.0	FCKC731-4M-2G
6	M5X0.8	8.0	17.5	19.0	FCKC731-6M-M5
	1/8	13.0	25.0	21.0	FCKC731-6M-2G
8	1/4	17.0	26.5	22.0	FCKC731-6M-4G
	1/8	13.0	25.0	26.0	FCKC731-8M-2G
8	1/4	17.0	26.5	27.0	FCKC731-8M-4G
	3/8	20.0	37.5	29.0	FCKC731-8M-6G
10	1/4	17.0	26.5	29.0	FCKC731-10M-4G
	3/8	20.0	37.5	31.0	FCKC731-10M-6G
12	1/2	23.0	43.0	37.0	FCKC731-10M-8G
	3/8	20.0	37.5	6.8	FCKC731-12M-6G
	1/2	23.0	43.0	37.0	FCKC731-12M-8G

Flow Controls & Check Valves

Misc Accessories

Integrated Fittings

Accessories



For inventory, lead times, and kit lookup, visit www.pdnplu.com

Miniature Flow Control Valves

The miniature flow control regulator is especially adapted for all very small sized pneumatic applications (micro-pneumatic in particular). They are specifically designed for use with small bore cylinders (pancake / flat cylinders). Miniature flow control regulators are available in meter out, meter in and Bi-Directional versions.

Material Specifications

Body (depending upon the model)	Glass reinforced nylon 6.6 Brass
Gripping Ring	Stainless Steel
Adjustment Screws	Nickel-plated brass
Locking Nut	Nickel-plated brass
Base	Nickel-plated brass

Applicable Tube

Tube O.D.	1/8, 5/32, 1/4
Tube O.D. (mm)	3, 4, 6, 8

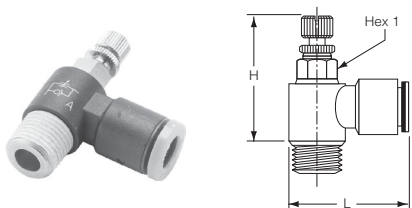

FCM731 Miniature Meter Out Flow Control - NPT

Tube size (in)	NPT	Hex 1 (mm)	H Open	H Closed	L	Part number
1/8	10-32	6	1.14	0.91	0.67	FCM731-2-0
	1/8	7	1.41	1.26	0.69	FCM731-2-2
5/32	10-32	6	1.02	0.93	0.67	FCM731-5/32-0
	1/8	7	1.16	1.06	0.71	FCM731-5/32-2
1/4	10-32	6	1.02	0.93	0.73	FCM731-4-0
	1/8	7	1.16	1.06	0.75	FCM731-4-2
	1/4	8	1.28	1.18	0.77	FCM731-4-4

FCM731 Miniature Meter Out Flow Control - BSPP

Tube size (mm)	BSPP	Hex 1 (mm)	H Closed	H Open	L	Part number
3	M3X0.5	6	23.5	26.0	17.0	FCM731-3M-M3
	M5X0.8	6	23.5	26.0	17.0	FCM731-3M-M5
4	M3X0.5	6	23.5	26.0	16.5	FCM731-4M-M3
	M5X0.8	6	23.5	26.0	17.0	FCM731-4M-M5
6	1/8	7	27.0	29.5	18.0	FCM731-4M-2G
	M5X0.8	6	23.5	26.0	18.0	FCM731-6M-M5
8	1/8	7	27.0	29.5	18.5	FCM731-6M-2G
	1/4	8	30.0	32.5	19.0	FCM731-6M-4G
8	1/8	13	26.5	31.0	26.0	FCM731-8M-2G
	1/4	16	29.0	34.0	27.5	FCM731-8M-4G
	3/8	20	36.0	42.0	29.0	FCM731-8M-6G

Most popular.



Operating information

Pressure range:	15 to 145 PSI
Temperature range:	30°F to 160°F
Working fluid:	Compressed air

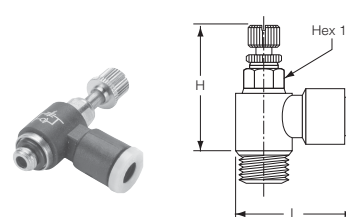

FCMB731 Miniature Bi-Directional Flow Control - BSPP

Tube size (mm)	BSPP	Hex 1	H Open	H Closed	L	Part number
4	M5X0.8	6	23.5	26.0	16.5	FCMB731-4M-M5
	1/8	7	27.0	29.5	17.0	FCMB731-4M-2G
6	M5X0.8	6	23.5	26.0	18.0	FCMB731-6M-M5
	1/8	7	27.0	29.5	18.0	FCMB731-6M-2G
6	1/4	8	30.0	32.5	18.5	FCMB731-6M-4G

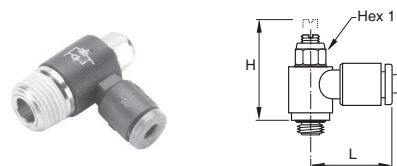

FCMB731 Miniature Bi-Directional Flow Control - BSPP

Tube size (in)	NPT	Hex 1 mm	H Open	H Closed	L	Part number
1/8	10-32	6	0.79	0.65	0.65	FCMK731-2-0
	1/8	6	0.85	0.71	0.71	FCMK731-2-2
5/32	10-32	6	0.79	0.65	0.65	FCMK731-5/32-0
	1/8	6	0.85	0.71	0.71	FCMK731-5/32-2
1/4	10-32	6	0.79	0.65	0.65	FCMK731-4-0
	1/8	6	0.85	0.71	0.73	FCMK731-4-2
	1/4	6	0.97	0.83	0.73	FCMK731-4-4

Flow Controls
& Check Valves

Misc
Accessories

Integrated
Fittings

Accessories



Swivel Outlet Flow Control Valves

Flow control regulators with “swivel outlet” are especially designed to allow a vertical or angled tube exit where access is restricted. The swivel outlet comes with instant push-in connection to ease installation. Flow control regulators with swivel outlet are available in meter out and meter in versions.



Material Specifications

Body	Glass reinforced nylon 6.6
Gripping Ring	Stainless Steel
Adjustment Screws	Nickel-plated brass
Locking Nut	Nickel-plated brass
Base	Nickel-plated brass

Applicable Tube

Tube O.D.	5/32, 1/4, 3/8
Tube O.D. (mm)	4, 6, 8, 10, 12

Operating information

Pressure range:	15 to 145 PSI
Temperature range:	30°F to 160°F
Working fluid:	Compressed air

Flow Controls
& Check Valves

Misc
Accessories

Integrated
Fittings

Accessories

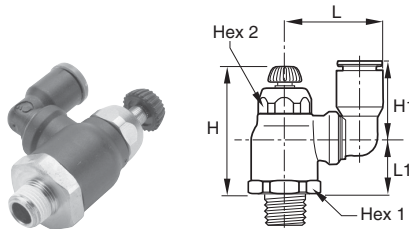

FCCS731 Compact Swivel Outlet Flow Control

Tube size (In)	NPT	Hex 1 mm	Hex 2 mm	H Closed	H Open	H1	L	L1	Part number
1/4	1/8	19	10	1.87	2.09	0.63	0.93	0.65	FCCS731-4-2
	1/4	19	14	1.79	1.99	0.73	1.00	0.89	FCCS731-4-4
3/8	1/4	23	17	1.93	2.20	1.04	1.34	0.97	FCCS731-6-4
	3/8	23	17	1.93	2.20	1.04	1.34	0.97	FCCS731-6-6

FCCS731 Compact Swivel Outlet - BSPP

Tube size (In)	BSPP	Hex 1 mm	Hex 2 mm	H Closed	H Open	H1	L	L1	Part number
6	1/8	16	10	38.0	44.0	16.0	23.5	18.0	FCCS731-6M-2G
	1/4	16	10	36.5	42.5	16.0	23.5	16.5	FCCS731-6M-4G
8	1/8	19	14	41.5	48.0	23.0	28.0	19.0	FCCS731-8M-2G
	1/4	19	14	41.5	48.0	23.0	28.0	19.5	FCCS731-8M-4G
10	3/8	19	14	41.5	48.0	23.0	28.0	17.5	FCCS731-8M-6G
	1/4	23	17	45.5	53.5	26.5	35.0	21.0	FCCS731-10M-4G
	3/8	23	17	45.5	54.0	26.5	35.0	21.5	FCCS731-10M-6G
12	3/8	23	17	45.5	54.0	31.0	38.0	21.5	FCCS731-12M-6G
	1/2	23	17	45.5	54.0	31.0	38.0	21.0	FCCS731-12M-8G

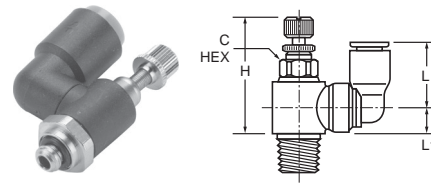

FCMS731 Mini Swivel Outlet Flow Control

Tube size (In)	NPT	Hex 1 mm	H Closed	H Open	H1	L	L1	Part number
5/32	10-32	6	0.96	1.08	0.55	0.73	0.26	FCMS731-5/32-0
	1/8	8	1.08	1.20	0.55	0.73	0.33	FCMS731-5/32-2

FCMS731 Miniature Swivel Outlet - BSPP

Tube size (In)	BSPP	Hex 1 mm	H Closed	H Open	H1	L	L1	Part number
4	M5X0.8	6	24.5	27.5	14.5	19.5	6.5	FCMS731-4M-M5
	1/8	7	27.5	31.0	14.5	20.0	8.5	FCMS731-4M-2G
6	M5X0.8	6	24.5	27.5	16.0	21.5	6.5	FCMS731-6M-M5
6	1/8	7	27.5	31.0	16.0	22.0	8.5	FCMS731-6M-2G



Plug-In Flow Control Valves

Plug-in flow control regulators can be directly mounted into existing fittings and allow very compact installations. They are particularly suited for mounting in manifolds using cartridges. Their design and function give equal performance to that of flow control regulators with threaded connections.

Material Specifications

Body	Glass reinforced nylon 6.6
Gripping Ring	Stainless Steel
Adjustment Screws	Nickel-plated brass
Locking Nut	Nickel-plated brass
Tailpiece	Nickel-plated brass

Applicable Tube

Tube O.D.	1/8, 5/32, 1/4
Tube O.D. (mm)	4, 6, 8, 10, 12



Operating information

Pressure range:	15 to 145 PSI
Temperature range:	30°F to 160°F
Working fluid:	Compressed air

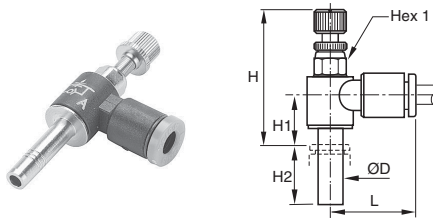

FCMS731 Plug-In Mini Flow Control

Tube size (In)	Hex 1 mm	H Open	H Closed	H1	H2	L	Part number
1/8	6	1.04	0.94	0.12	0.59	0.67	FCMS731-2
5/32	6	1.10	1.00	0.37	0.61	0.67	FCMS731-5/32
1/4	7	1.18	1.08	0.12	0.73	0.73	FCMS731-4

FCMS701 - Plug-In Miniature Flow Control

Tube size (mm)	Hex 1 mm	H Closed	H Open	H1	H2	L	Part number
4	6	25.5	28.0	9.5	15.5	17.0	FCMS701-4M
6	7	27.5	29.0	10.5	17.0	18.5	FCMS701-6M

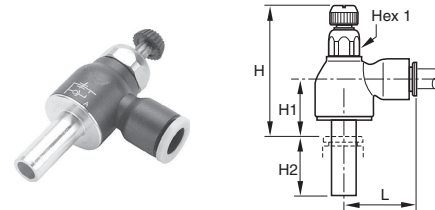

FCCSP731 Plug-In Compact Flow Control

Tube size (mm)	Hex 1 mm	H Closed	H Open	H1	H2	L	Part number
6	10	35.0	41.0	14.0	17.0	22.0	FCCSP731-6M
8	14	39.5	46.5	16.0	21.5	28.0	FCCSP731-8M
10	17	43.5	51.5	17.5	24.5	31.5	FCCSP731-10M
12	17	43.0	51.0	17.0	27.0	31.5	FCCSP731-12M

Flow Controls
& Check Valves

Misc
Accessories

Integrated
Fittings

Accessories



In-Line Flow Control Valves

In-line flow controls are unidirectional flow control valves. Intake air flows freely through the flow control; exhaust air is metered out through a specially designed adjustment screw. An arrow on the body of the valve indicates the direction of controlled flow. They can be easily added to existing circuitry. Simply splice it into the cylinder port line.

They can be used individually or they may be stacked together using two joining clips.

Material Specifications

Body	Glass reinforced nylon 6.6
Gripping Ring	Stainless Steel
Adjustment Screws	Nickel-plated brass
Locking Nut	Nickel-plated brass
Tailpiece	Nickel-plated brass

Applicable Tube

Tube O.D.	5/32, 1/4, 5/16, 3/8, 1/2
Tube O.D. (mm)	4, 6, 8, 10, 12

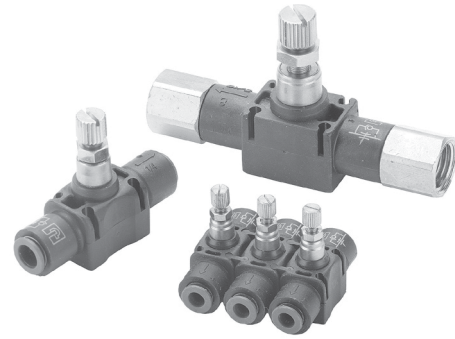

Operating information

Pressure range:	15 to 145 PSI
Temperature range:	30°F to 160°F
Working fluid:	Compressed air

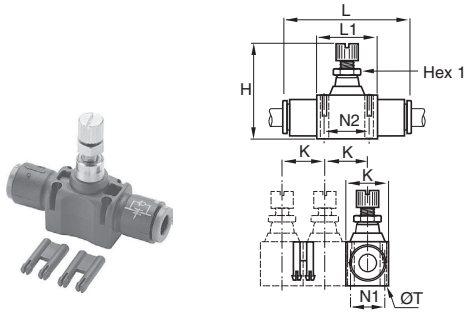

FC832 In-Line Flow Control

Tube size (In)	Hex 1 mm	H Closed	H Open	K	L	L1	N1	N2	T	Part number
5/32	5	1.15	1.31	0.47	1.52	0.59	0.31	0.43	0.09	FC832-5/32
1/4	8	1.54	1.74	0.66	2.00	0.90	0.43	0.66	0.12	FC832-4
5/16	11	1.73	1.97	0.73	2.38	1.02	0.49	0.79	0.13	FC832-5
3/8	14	2.03	2.38	0.94	2.87	1.29	0.62	1.01	1.60	FC832-6
1/2	14	2.24	2.63	1.09	3.35	1.37	0.78	1.07	0.16	FC832-8

FC832 In-Line Flow Control

Tube size (mm)	Hex 1 mm	H Closed	H Open	K	L	L1	N1	N2	T	Part number
4	5	29.5	33.5	12.0	39.0	15.0	8.0	11.0	2.2	FC832-4M
6	8	39.5	44.5	17.0	54.0	23.0	11.0	17.0	3.2	FC832-6M
8	11	44.0	50.0	18.5	60.5	26.0	12.5	20.0	3.2	FC832-8M
10	14	52.0	61.0	24.0	76.0	33.0	16.0	26.0	4.2	FC832-10M
12	14	57.5	67.5	28.0	86.0	35.0	20.0	27.5	4.2	FC832-12M

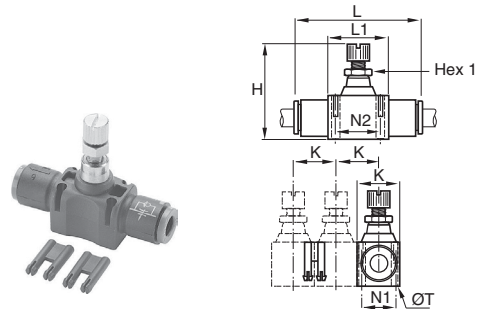

FCB832 In-Line Bi-Directional Flow Control

Tube size (In)	Hex 1 mm	H Closed	H Open	K	L	L1	N1	N2	T	Part number
5/32	5	1.15	1.31	0.47	1.52	0.59	0.31	0.43	0.09	FCB832-5/32
1/4	8	1.54	1.74	0.66	2.00	0.90	0.43	0.66	0.12	FCB832-4
5/16	11	1.73	1.97	0.73	2.38	1.02	0.49	0.79	0.13	FCB832-5

FCB832 In-Line Bi-Directional Flow Control

Tube size (mm)	Hex 1 mm	H Closed	H Open	K	L	L1	N1	N2	T	Part number
4	5	29.5	33.5	12.0	39.0	15.0	8.0	11.0	2.2	FCB832-4M
6	8	39.5	44.5	17.0	54.0	23.0	11.0	17.0	3.2	FCB832-6M
8	11	44.0	50.0	18.5	60.5	26.0	12.5	20.0	3.2	FCB832-8M

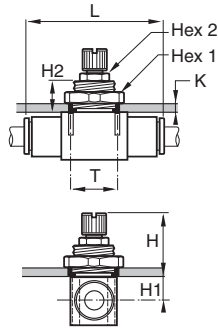
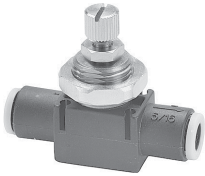

FCPM832 In-Line Panel Mountable Flow Control

Tube size (mm)	Hex 1 mm	Hex 2 mm	H Closed	H Open	K	L	H1	H2	T	Part number
4	14		21.5	25.5	6.0	39.0	6.5	11.0	10.5	FCPM832-4M
6	19		27.5	32.5	7.0	54.0	7.5	13.5	16.5	FCPM832-6M
8	24	11	28.5	34.5	7.0	60.5	9.0	13.5	18.5	FCPM832-8M
10	30	14	29.5	38.5	7.0	76.0	11.5	13.5	24.5	FCPM832-10M
12	32	14	32.0	42.0	8.0	86.0	12.5	15.5	27.5	FCPM832-12M

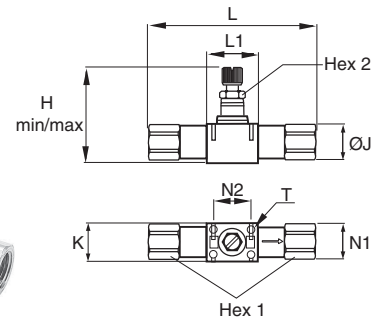

FC836 Threaded In-Line Flow Control

NPT	Hex 1 mm	Hex 2 mm	H Closed	H Open	K	L	L1	N1	N2	T	Part number
1/8	13	8.00	1.56	1.75	0.67	2.70	0.91	0.43	0.67	0.12	FC836-2
1/4	16	11.00	1.73	1.97	0.73	3.27	1.02	0.49	0.79	0.12	FC836-4
3/8	22	14.00	2.05	2.40	0.94	3.82	1.30	0.63	1.02	0.16	FC836-6
1/2	24	14.00	2.26	2.66	1.10	4.76	1.38	0.79	1.08	0.16	FC836-8

FC836 Threaded In-Line Flow Control - BSPP

BSPP	Hex 1 mm	Hex 2 mm	H Closed	H Open	K	L	L1	N1	N2	T	Part number
1/8	13	8	39.5	44.5	17.0	68.5	23.1	11.0	17.0	3.2	FC836-2G
1/4	16	11	44.0	50.0	18.5	83.0	25.9	12.5	20.0	3.2	FC836-4G
3/8	19	14	52.0	61.0	24.0	97.0	33.0	16.0	26.0	4.2	FC836-6G
1/2	24	14	57.5	67.5	28.0	121.0	35.0	20.0	27.5	4.2	FC836-8G

Flow Controls & Check Valves

Misc Accessories

Integrated Fittings

Accessories



Compact Metal Flow Control Valves

Metal flow control regulators are suited for use in severe conditions (temperatures, sparks, abrasion, etc). The screw and locking nut have been designed for easy manipulation, by hand. Adjustment can be made with a screwdriver and locking by use of a wrench.



Material Specifications

Body	Treated brass
Gripping Ring	Stainless Steel
Adjustment Screws	Nickel-plated brass
Locking Nut	Nickel-plated brass
Tailpiece	Nickel-plated brass

Applicable Tube

Tube O.D.	1/8, 5/32, 1/4, 3/8
Tube O.D. (mm)	4, 6, 8, 10, 12, 14

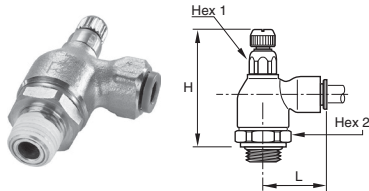

FC705 Push-to-Connect Metal Flow Control

Tube size (In)	NPT	Hex 1 mm	Hex 2 mm	H Closed	H Open	L	Part number
5/32	1/8	19	10	1.79	2.01	0.85	FC705-5/32-2
1/4	1/8	19	10	1.79	2.01	0.97	FC705-4-2
	1/4	19	10	1.79	2.01	0.97	FC705-4-4
3/8	1/4	19	14	1.91	2.11	1.14	FC705-6-4
	3/8	25	17	2.15	2.40	1.40	FC705-6-6

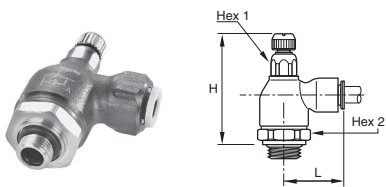

FC701 Push-to-Connect Metal Flow Control - BSPP

Tube size (mm)	BSPP	Hex 1 mm	Hex 2 mm	H Closed	H Open	L	Part number
4	1/8	10	19	47.0	53.0	21.0	FC701-4M-2G
	1/8	10	19	47.0	53.0	24.5	FC701-6M-2G
6	1/4	10	19	47.5	53.0	24.5	FC701-6M-4G
	1/8	14	19	50.0	55.0	29.0	FC701-8M-2G
8	1/4	14	19	50.0	56.0	29.0	FC701-8M-4G
	3/8	17	25	56.0	62.0	30.5	FC701-8M-6G
10	1/4	14	19	50.0	56.0	35.0	FC701-10M-4G
	3/8	17	25	56.0	62.0	35.0	FC701-10M-6G
12	3/8	17	25	56.0	62.0	38.0	FC701-12M-6G
	1/2	17	25	55.0	62.0	38.0	FC701-12M-8G
14	1/2	17	25	55.0	62.0	41.0	FC701-14M-8G

Operating information

Pressure range:	15 to 145 PSI
Temperature range:	30°F to 160°F
Working fluid:	Compressed air

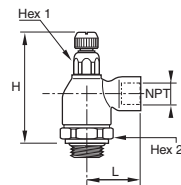

FC708 Threaded Port Meter Out Flow Control

NPT	Hex 1 mm	Hex 2 mm	H Closed	H Open	L	L1	L2	Part number
1/8	19	10	1.79	2.01	0.89	0.87	1.14	FC708-2
1/4	19	14	1.91	2.11	1.28	0.87	1.28	FC708-4
3/8	25	17	2.15	2.40	1.36	0.91	1.44	FC708-6
1/2	25	17	2.15	2.40	1.50	0.91	1.50	FC708-8

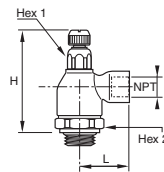

FC702 Threaded Port Meter Out Flow Control - BSPP

BSPP	Hex 1 mm	Hex 2 mm	H Closed	H Open	L	Part number
1/8	10	19	47.0	52.5	22.5	FC702-2G
1/4	14	19	50.5	55.5	32.0	FC702-4G
3/8	17	25	56.0	62.0	34.5	FC702-6G
1/2	17	25	55.0	62.0	37.5	FC702-8G

Flow Control Check Valves

These in-line check valves allows air to pass in one direction while blocking flow in the other direction. Their extreme compactness and light weight make them suitable as a safety item in compressed air circuits. The body of the fitting contains an arrow to indicate the direction of flow.

Material Specifications

Body	32PLCK: Nylon/nickel plated brass
	68PLCK: Nylon body with nickel-plated brass base
	VC: Acetal
Gripping Ring	Stainless Steel
O-ring	Nitrile (32PLCK & 68PLCK)
	EPDM (VC)

Applicable Tube

Tube O.D.	PLCK: 5/32, 1/4, 5/16, 3/8
	VC: 1/4, 5/16, 3/8
Tube O.D. (mm)	PLCK: 4, 6, 8, 10, 12



Operating information

Pressure range:	15 to 145 PSI
Temperature range:	34°F to 150°F
Cracking pressure:	PLCK: 7 PSI
	VC: 1/3 PSI
Working fluid:	Compressed air

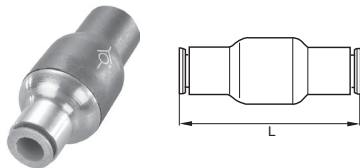

32PLCK In-Line Check Valve - NPT

Tube size (In)	L	Part number
5/32	1.52	32PLCK-5/32
1/4	1.61	32PLCK-4
5/16	2.03	32PLCK-5
3/8	2.50	32PLCK-6

32PLCK In-Line Check Valve - BSPP

Tube size (mm)	L	Part number
4	38.5	32PLCK-4M
6	41.0	32PLCK-6M
8	51.5	32PLCK-8M
10	63.5	32PLCK-10M
12	66.5	32PLCK-12M

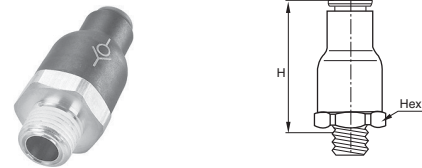

W68PLCK Male Check Valve

Tube size (In)	NPT/ UNF	Hex mm	H	Part number
5/32	10-32	9	1.26	68PLCK-5/32-0
5/32	1/8	16	1.12	W68PLCK-5/32-2
1/4	1/8	19	1.42	W68PLCK-4-2
1/4	1/4	19	1.42	W68PLCK-4-4
3/8	1/4	23	1.65	W68PLCK-6-4
3/8	3/8	23	1.65	W68PLCK-6-6

W68PLCKI Male Check Valve Meter In

Tube size (in)	NPT/ UNF	Hex mm	H	Part number
5/32	10-32	9	1.26	68PLCKI-5/32-0
5/32	1/8	16	1.12	W68PLCKI-5/32-2
1/4	1/8	19	1.42	W68PLCKI-4-2
1/4	1/4	19	1.42	W68PLCKI-4-4
3/8	1/4	23	1.65	W68PLCKI-6-4
3/8	3/8	23	1.65	W68PLCKI-6-6

Flow Controls
& Check Valves

Misc
Accessories

Integrated
Fittings

Accessories



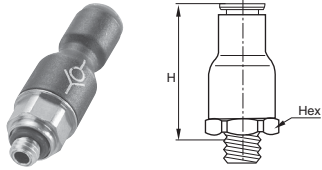

68PLCK Male Check Valve Meter Out - BSPP

Tube size (mm)	BSPP	Hex 1 mm	H	Part number
4	M5X0.8	9	32.0	68PLCK-4M-M5
4	1/8	16	28.5	68PLCK-4M-2G
6	1/8	16	30.5	68PLCK-6M-2G
6	1/4	16	30.5	68PLCK-6M-4G
8	1/8	19	36.0	68PLCK-8M-2G
8	1/4	19	36.0	68PLCK-8M-4G

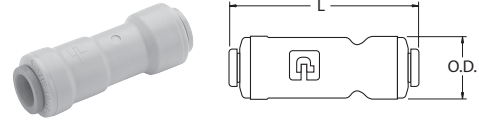

VC - Check Valve

Tube size (in)	BSPP	Hex 1 mm	Part number
1/4	2.00	.66	A4VC4-MG
5/16	2.10	.70	A5VC5-MG
3/8	2.15	.80	A6VC6-MG

68PLCKI Male Check Valve Meter In - BSPP

Tube size (mm)	BSPP	Hex 1 mm	H	Part number
4	M5X0.8	9	32.0	68PLCKI-4M-M5
6	1/8	16	30.5	68PLCKI-6M-2G
8	1/8	19	36.0	68PLCKI-8M-2G
8	1/4	19	36.0	68PLCKI-8M-4G
10	3/8	23	42.0	68PLCKI-10M-6G
12	3/8	23	42.0	68PLCKI-12M-6G
12	1/2	23	44.0	68PLCKI-12M-8G

Flow Controls
 & Check Valves

Misc
 Accessories

Integrated
 Fittings

Accessories



Blocking Flow Control Valves

Blocking valves prevents damage to work and equipment in the event of a loss of pressure. Blocking valves which are mounted in pairs on a cylinder lock the piston by simultaneously cutting off the supply and exhaust. Functional locks are more precise and rapid when blocking valves are located on the cylinder: the volume of air in the pipe work no longer needs to be taken into consideration.



Material Specifications

Body	Treated brass
Gripping Ring	Stainless Steel
Seals, Diaphragm	Nitrile

Applicable Tube

Tube O.D.	1/8, 5/32, 1/4, 3/8
Tube O.D. (mm)	4, 6, 8, 10, 12, 14

Operating information

Pressure range:	15 to 145 PSI
Temperature range:	-4°F to 160°F
Number of cycles:	> 10 million at 68°F and 1 Hz
Leak rate:	< 3.2 CCM
Working fluid:	Compressed air

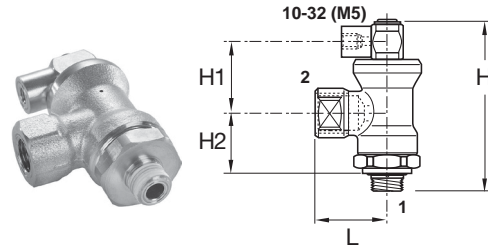
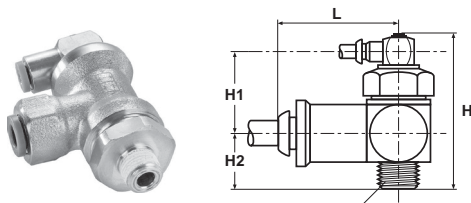

FC601 Push-to-Connect Lockout Valves

Tube size (In)	NPT	Hex mm	H	H1	H2	L	Part number
1/4	1/8	21	2.03	1.24	0.79	1.10	FC601-4-2
1/4	1/4	21	2.03	1.24	0.79	1.10	FC601-4-4
3/8	3/8	24	2.19	1.14	1.04	1.38	FC601-6-6
1/2	1/2	24	2.19	1.14	1.04	1.69	FC601-8-8

FC601 Push-to-Connect Lockout Valve - BSPP

Tube size (mm)	BSPP	Hex 1 mm	H	H1	H2	L	Part number
6	1/8	21	53	24.5	21.0	28.0	FC601-6M-2G
6	1/4	21	53	24.5	21.0	28.0	FC601-6M-4G
8	1/4	21	53	24.5	21.0	28.0	FC601-8M-4G
8	3/8	24	56	25.0	23.0	34.5	FC601-8M-6G
10	3/8	24	56	25.0	23.0	35.0	FC601-10M-6G
12	1/2	24	56	25.0	23.0	37.5	FC601-12M-8G

FC602 Threaded Port Lockout Valves

1 NPT	2 NPT	Hex mm	H	H1	H2	L	Part number
1/4	1/8	21	2.03	1.24	0.79	1.04	FC602-2
1/4	1/4	21	2.03	1.24	0.79	1.04	FC602-4
3/8	3/8	24	2.19	1.14	1.04	1.34	FC602-6
1/2	1/2	24	2.19	1.14	1.04	1.57	FC602-8

FC608 Threaded Port Lockout Valve - BSPP

1 BSPP	2 BSPP	Hex 1 mm	H	H1	H2	L	Part number
1/8	1/4	21	53	24.5	21.0	28.0	FC608-4G-2G
1/4	1/4	21	53	24.5	21.0	28.0	FC608-4G-4G
3/8	3/8	24	56	25.0	23.0	34.0	FC608-6G-6G
1/2	1/2	24	56	25.0	23.0	41.0	FC608-8G-8G

Flow Controls & Check Valves

Misc Accessories

Integrated Fittings

Accessories



Threshold Sensor

The sensor fitting detects the absence of pressure and translates it to a high pressure pneumatic output. When used to monitor the decaying or exhausting side of a pneumatic cylinder's piston, it emits a positive output. When the cylinder comes to the end of its stroke, wherever that may be, the signal emitted from the sensor can then be used to pilot the next step.

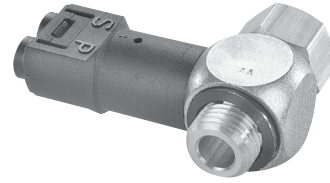

Operating information

	PSBJ, PSPJ	PSPE
Working pressure:	45 to 115 PSI	45 to 115 PSI
Breaking pressure:	8.5 PSI	7 PSI
Working temperature:	5°F to 140°F	–
Response time:	3 Ms	–
Current rating:	–	5A / 250VAC 5W / 48VDC
Reset pressure:	10 PSI	10 PSI
UL listed component		

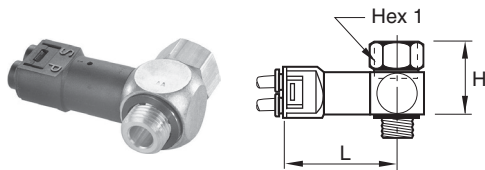

PSBJ731 Pneumatic Threshold Sensor - 5/32 Pilot

NPT / UNF	Hex 1 mm	H	L	Part number
10-32	5/16	0.62	1.70	PSBJ731-0
1/8	9/16	0.90	1.74	PSBJ731-2
1/4	5/8	1.09	1.81	PSBJ731-4
3/8	7/8	1.13	1.91	PSBJ731-6
1/2	1	1.17	2.05	PSBJ731-8

PSBJ731 Pneumatic Threshold Sensor - 4mm Pilot

BSPP	Hex 1 mm	H	L	Part number
M5X0.8	8	16	43.5	PSBJ731-M5
1/8	14	23	44.5	PSBJ731-2G
1/4	17	28	46.5	PSBJ731-4G
3/8	22	29	49.0	PSBJ731-6G
1/2	27	30	52.5	PSBJ731-8G

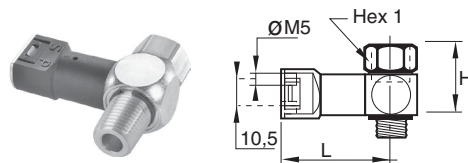

PSPJ731 Pneumatic Threshold Sensor - 10-32 Pilot

NPT	Hex 1 mm	H	L	Part number
1/8	9/16	0.90	1.58	PSPJ731-2
1/4	5/8	1.09	1.66	PSPJ731-4
3/8	7/8	1.13	1.76	PSPJ731-6

PSBJ708 Pneumatic Threshold Sensor - M5 Pilot

BSPP	Hex 1 mm	H	L	Part number
1/8	14	23	40.5	PSBJ708-2G
1/4	17	28	42.5	PSBJ708-4G

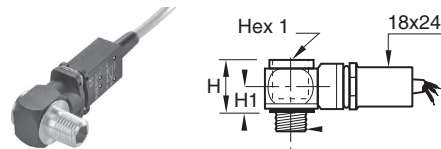

PSPE701 Pneumatic / Electric Threshold Sensor - BSPP

NPT	Hex 1 mm	H	H1	L	Part number
M5X0.8	8	20	10	49	PSPE701-M5
1/8	6	20	10	52	PSPE701-2G
1/4	8	20	10	54	PSPE701-4G
3/8	10	22	12	57	PSPE701-6G
1/2	12	26	14	58	PSPE701-8G

Safety Guide For Selecting And Using Pneumatic Division Products And Related Accessories

WARNING:

FAILURE OR IMPROPER SELECTION OR IMPROPER USE OF PNEUMATIC DIVISION PRODUCTS, ASSEMBLIES OR RELATED ITEMS ("PRODUCTS") CAN CAUSE DEATH, PERSONAL INJURY, AND PROPERTY DAMAGE. POSSIBLE CONSEQUENCES OF FAILURE OR IMPROPER SELECTION OR IMPROPER USE OF THESE PRODUCTS INCLUDE BUT ARE NOT LIMITED TO:

- Unintended or mistimed cycling or motion of machine members or failure to cycle
- Work pieces or component parts being thrown off at high speeds.
- Failure of a device to function properly for example, failure to clamp or unclamp an associated item or device.
- Explosion
- Suddenly moving or falling objects.
- Release of toxic or otherwise injurious liquids or gasses.

Before selecting or using any of these Products, it is important that you read and follow the instructions below.

1. GENERAL INSTRUCTIONS

- 1.1. Scope:** This safety guide is designed to cover general guidelines on the installation, use, and maintenance of Pneumatic Division Valves, FRLs (Filters, Pressure Regulators, and Lubricators), Vacuum products and related accessory components.
- 1.2. Fail-Safe:** Valves, FRLs, Vacuum products and their related components can and do fail without warning for many reasons. Design all systems and equipment in a fail-safe mode, so that failure of associated valves, FRLs or Vacuum products will not endanger persons or property.
- 1.3. Relevant International Standards:** For a good guide to the application of a broad spectrum of pneumatic fluid power devices see: ISO 4414:1998, Pneumatic Fluid Power – General Rules Relating to Systems. See www.iso.org for ordering information.
- 1.4. Distribution:** Provide a copy of this safety guide to each person that is responsible for selection, installation, or use of Valves, FRLs or Vacuum products. Do not select, or use Parker valves, FRLs or vacuum products without thoroughly reading and understanding this safety guide as well as the specific Parker publications for the products considered or selected.
- 1.5. User Responsibility:** Due to the wide variety of operating conditions and applications for valves, FRLs, and vacuum products Parker and its distributors do not represent or warrant that any particular valve, FRL or vacuum product is suitable for any specific end use system. This safety guide does not analyze all technical parameters that must be considered in selecting a product. The user, through its own analysis and testing, is solely responsible for:
 - Making the final selection of the appropriate valve, FRL, Vacuum component, or accessory.
 - Assuring that all user's performance, endurance, maintenance, safety, and warning requirements are met and that the application presents no health or safety hazards.
 - Complying with all existing warning labels and / or providing all appropriate health and safety warnings on the equipment on which the valves, FRLs or Vacuum products are used; and,
 - Assuring compliance with all applicable government and industry standards.
- 1.6. Safety Devices:** Safety devices should not be removed, or defeated.
- 1.7. Warning Labels:** Warning labels should not be removed, painted over or otherwise obscured.
- 1.8. Additional Questions:** Call the appropriate Parker technical service department if you have any questions or require any additional information. See the Parker publication for the product being considered or used, or call 1-800-CPARKER, or go to www.parker.com, for telephone numbers of the appropriate technical service department.

2. PRODUCT SELECTION INSTRUCTIONS

- 2.1. Flow Rate:** The flow rate requirements of a system are frequently the primary consideration when designing any pneumatic system. System components need to be able to provide adequate flow and pressure for the desired application.
- 2.2. Pressure Rating:** Never exceed the rated pressure of a product. Consult product labeling, Pneumatic Division catalogs or the instruction sheets supplied for maximum pressure ratings.
- 2.3. Temperature Rating:** Never exceed the temperature rating of a product. Excessive heat can shorten the life expectancy of a product and result in complete product failure.
- 2.4. Environment:** Many environmental conditions can affect the integrity and suitability of a product for a given application. Pneumatic Division products are designed for use in general purpose industrial applications. If these products are to be used in unusual circumstances such as direct sunlight and/or corrosive or caustic environments, such use can shorten the useful life and lead to premature failure of a product.
- 2.5. Lubrication and Compressor Carryover:** Some modern synthetic oils can and will attack nitrile seals. If there is any possibility of synthetic oils or greases migrating into the pneumatic components check for compatibility with the seal materials used. Consult the factory or product literature for materials of construction.
- 2.6. Polycarbonate Bowls and Sight Glasses:** To avoid potential polycarbonate bowl failures:
 - Do not locate polycarbonate bowls or sight glasses in areas where they could be subject to direct sunlight, impact blow, or temperatures outside of the rated range.
 - Do not expose or clean polycarbonate bowls with detergents, chlorinated hydro-carbons, ketones, esters or certain alcohols.
 - Do not use polycarbonate bowls or sight glasses in air systems where compressors are lubricated with fire resistant fluids such as phosphate ester and di-ester lubricants.

Part Number
Index

Safety
Guide

Offer of
Sale

Part Number Index,
Safety Guide, Offer of Sale

G



For inventory, lead time, and kit lookup, visit www.pdnplu.com

G27

Parker Hannifin Corporation
Pneumatic Division
Richland, Michigan
www.parker.com/pneumatics

2.7. Chemical Compatibility: For more information on plastic component chemical compatibility see Pneumatic Division technical bulletins Tec-3, Tec-4, and Tec-5

2.8. Product Rupture: Product rupture can cause death, serious personal injury, and property damage.

- Do not connect pressure regulators or other Pneumatic Division products to bottled gas cylinders.
- Do not exceed the maximum primary pressure rating of any pressure regulator or any system component.
- Consult product labeling or product literature for pressure rating limitations.

3. PRODUCT ASSEMBLY AND INSTALLATION INSTRUCTIONS

3.1. Component Inspection: Prior to assembly or installation a careful examination of the valves, FRLs or vacuum products must be performed. All components must be checked for correct style, size, and catalog number. DO NOT use any component that displays any signs of nonconformance.

3.2. Installation Instructions: Parker published Installation Instructions must be followed for installation of Parker valves, FRLs and vacuum components. These instructions are provided with every Parker valve or FRL sold, or by calling 1-800-CPARKER, or at www.parker.com.

3.3. Air Supply: The air supply or control medium supplied to Valves, FRLs and Vacuum components must be moisture-free if ambient temperature can drop below freezing

4. VALVE AND FRL MAINTENANCE AND REPLACEMENT INSTRUCTIONS

4.1. Maintenance: Even with proper selection and installation, valve, FRL and vacuum products service life may be significantly reduced without a continuing maintenance program. The severity of the application, risk potential from a component failure, and experience with any known failures in the application or in similar applications should determine the frequency of inspections and the servicing or replacement of Pneumatic Division products so that products are replaced before any failure occurs. A maintenance program must be established and followed by the user and, at minimum, must include instructions 4.2 through 4.9.

4.2. Installation and Service Instructions: Before attempting to service or replace any worn or damaged parts consult the appropriate Service Bulletin for the valve or FRL in question for the appropriate practices to service the unit in question. These Service and Installation Instructions are provided with every Parker valve and FRL sold, or are available by calling 1-800-CPARKER, or by accessing the Parker web site at www.parker.com.

4.3. Lockout / Tagout Procedures: Be sure to follow all required lockout and tagout procedures when servicing equipment. For more information see: OSHA Standard – 29 CFR, Part 1910.147, Appendix A, The Control of Hazardous Energy – (Lockout / Tagout)

4.4. Visual Inspection: Any of the following conditions requires immediate system shut down and replacement of worn or damaged components:

- Air leakage: Look and listen to see if there are any signs of visual damage to any of the components in the system. Leakage is an indication of worn or damaged components.
- Damaged or degraded components: Look to see if there are any visible signs of wear or component degradation.
- Kinked, crushed, or damaged hoses. Kinked hoses can result in restricted air flow and lead to unpredictable system behavior.
- Any observed improper system or component function: Immediately shut down the system and correct malfunction.
- Excessive dirt build-up: Dirt and clutter can mask potentially hazardous situations.

Caution: Leak detection solutions should be rinsed off after use.

4.5. Routine Maintenance Issues:

- Remove excessive dirt, grime and clutter from work areas.
- Make sure all required guards and shields are in place.

4.6. Functional Test: Before initiating automatic operation, operate the system manually to make sure all required functions operate properly and safely.

4.7. Service or Replacement Intervals: It is the user's responsibility to establish appropriate service intervals. Valves, FRLs and vacuum products contain components that age, harden, wear, and otherwise deteriorate over time. Environmental conditions can significantly accelerate this process. Valves, FRLs and vacuum components need to be serviced or replaced on routine intervals. Service intervals need to be established based on:

- Previous performance experiences.
- Government and / or industrial standards.
- When failures could result in unacceptable down time, equipment damage or personal injury risk.

4.8. Servicing or Replacing of any Worn or Damaged Parts: To avoid unpredictable system behavior that can cause death, personal injury and property damage:

- Follow all government, state and local safety and servicing practices prior to service including but not limited to all OSHA Lockout Tagout procedures (OSHA Standard – 29 CFR, Part 1910.147, Appendix A, The Control of Hazardous Energy – Lockout / Tagout).
- Disconnect electrical supply (when necessary) before installation, servicing, or conversion.
- Disconnect air supply and depressurize all air lines connected to system and Pneumatic Division products before installation, service, or conversion.
- Installation, servicing, and / or conversion of these products must be performed by knowledgeable personnel who understand how pneumatic products are to be applied.
- After installation, servicing, or conversions air and electrical supplies (when necessary) should be connected and the product tested for proper function and leakage. If audible leakage is present, or if the product does not operate properly, do not put product or system into use.
- Warnings and specifications on the product should not be covered or painted over. If masking is not possible, contact your local representative for replacement labels.

4.9. Putting Serviced System Back into Operation: Follow the guidelines above and all relevant Installation and Maintenance Instructions supplied with the valve FRL or vacuum component to insure proper function of the system.



PARKER-HANNIFIN CORPORATION
OFFER OF SALE

1. **Definitions.** As used herein, the following terms have the meanings indicated.

Buyer:	means any customer receiving a Quote for Products from Seller.
Goods:	means any tangible part, system or component to be supplied by the Seller.
Products:	means the Goods, Services and/or Software as described in a Quote provided by the Seller.
Quote:	means the offer or proposal made by Seller to Buyer for the supply of Products.
Seller:	means Parker-Hannifin Corporation, including all divisions and businesses thereof.
Services:	means any services to be supplied by the Seller.
Software:	means any software related to the Products, whether embedded or separately downloaded.
Terms:	means the terms and conditions of this Offer of Sale or any newer version of the same as published by Seller electronically at www.parker.com/saleterms .

2. **Terms.** All sales of Products by Seller are contingent upon, and will be governed by, these Terms and, these Terms are incorporated into any Quote provided by Seller to any Buyer. Buyer's order for any Products whether communicated to Seller verbally, in writing, by electronic data interface or other electronic commerce, shall constitute acceptance of these Terms. Seller objects to any contrary or additional terms or conditions of Buyer. Reference in Seller's order acknowledgement to Buyer's purchase order or purchase order number shall in no way constitute an acceptance of any of Buyer's terms of purchase. No modification to these Terms will be binding on Seller unless agreed to in writing and signed by an authorized representative of Seller.

3. **Price; Payment.** The Products set forth in Seller's Quote are offered for sale at the prices indicated in Seller's Quote. Unless otherwise specifically stated in Seller's Quote, prices are valid for thirty (30) days and do not include any sales, use, or other taxes or duties. Seller reserves the right to modify prices at any time to adjust for any raw material price fluctuations. Unless otherwise specified by Seller, all prices are F.C.A. Seller's facility (INCOTERMS 2010). All sales are contingent upon credit approval and payment for all purchases is due thirty (30) days from the date of invoice (or such date as may be specified in the Quote). Unpaid invoices beyond the specified payment date incur interest at the rate of 1.5% per month or the maximum allowable rate under applicable law.

4. **Shipment; Delivery; Title and Risk of Loss.** All delivery dates are approximate. Seller is not responsible for damages resulting from any delay. Regardless of the manner of shipment, delivery occurs and title and risk of loss or damage pass to Buyer, upon placement of the Products with the shipment carrier at Seller's facility. Unless otherwise agreed, Seller may exercise its judgment in choosing the carrier and means of delivery. No deferment of shipment at Buyer's request beyond the respective indicated shipping date will be made except on terms that will indemnify, defend and hold Seller harmless against all loss and additional expense. Buyer shall be responsible for any additional shipping charges incurred by Seller due to Buyer's acts or omissions.

5. **Warranty.** The warranty related to the Products is as follows: (i) Goods are warranted against defects in material or workmanship for a period of twelve (12) months from the date of delivery or 2,000 hours of use, whichever occurs first; (ii) Services shall be performed in accordance with generally accepted practices and using the degree of care and skill that is ordinarily exercised and customary in the field to which the Services pertain and are warranted for a period of six (6) months from the completion of the Services by Seller; and (iii) Software is only warranted to perform in accordance with applicable specifications provided by Seller to Buyer for ninety (90) days from the date of delivery or, when downloaded by a Buyer or end-user, from the date of the initial download. All prices are based upon the exclusive limited warranty stated above, and upon the following disclaimer:

DISCLAIMER OF WARRANTY: THIS WARRANTY IS THE SOLE AND ENTIRE WARRANTY PERTAINING TO PRODUCTS. SELLER DISCLAIMS ALL OTHER WARRANTIES, EXPRESS AND IMPLIED, INCLUDING DESIGN, NONINFRINGEMENT, MERCHANTABILITY, AND FITNESS FOR A PARTICULAR PURPOSE. SELLER DOES NOT WARRANT THAT THE SOFTWARE IS ERROR-FREE OR FAULT-TOLERANT, OR THAT BUYER'S USE THEREOF WILL BE SECURE OR UNINTERRUPTED. BUYER AGREES AND ACKNOWLEDGES THAT UNLESS OTHERWISE AUTHORIZED IN WRITING BY SELLER THE SOFTWARE SHALL NOT BE USED IN CONNECTION WITH HAZARDOUS OR HIGH RISK ACTIVITIES OR ENVIRONMENTS. EXCEPT AS EXPRESSLY STATED HEREIN, ALL PRODUCTS ARE PROVIDED "AS IS".

6. **Claims; Commencement of Actions.** Buyer shall promptly inspect all Products upon receipt. No claims for shortages will be allowed unless reported to the Seller within ten (10) days of delivery. Buyer shall notify Seller of any alleged breach of warranty within thirty (30) days after the date the non-conformance is or should have been discovered by Buyer. Any claim or action against Seller based upon breach of contract or any other theory, including tort, negligence, or otherwise must be commenced within twelve (12) months from the date of the alleged breach or other alleged event, without regard to the date of discovery.

7. **LIMITATION OF LIABILITY.** IN THE EVENT OF A BREACH OF WARRANTY, SELLER WILL, AT ITS OPTION, REPAIR OR REPLACE THE NON-CONFORMING PRODUCT, RE-PERFORM THE SERVICES, OR REFUND THE PURCHASE PRICE PAID WITHIN A REASONABLE PERIOD OF TIME. IN NO EVENT IS SELLER LIABLE FOR ANY SPECIAL, INDIRECT, INCIDENTAL OR CONSEQUENTIAL DAMAGES ARISING OUT OF, OR AS THE RESULT OF, THE SALE, DELIVERY, NON-DELIVERY, SERVICING, NON-COMPLETION OF SERVICES, USE, LOSS OF USE OF, OR INABILITY TO USE THE PRODUCTS OR ANY PART THEREOF, LOSS OF DATA, IDENTITY, PRIVACY, OR CONFIDENTIALITY, OR FOR ANY CHARGES OR EXPENSES OF ANY NATURE INCURRED WITHOUT SELLER'S WRITTEN CONSENT, WHETHER BASED IN CONTRACT, TORT OR OTHER LEGAL THEORY. IN NO EVENT SHALL SELLER'S LIABILITY UNDER ANY CLAIM MADE BY BUYER EXCEED THE PURCHASE PRICE PAID FOR THE PRODUCTS.

8. **Loss to Buyer's Property.** Any designs, tools, patterns, materials, drawings, confidential information or equipment furnished by Buyer or any other items which are or become Buyer's property, will be considered obsolete and may be destroyed by Seller after two (2) consecutive years have elapsed without Buyer ordering the Products manufactured using such property. Seller shall not be responsible for any loss or damage to such property while it is in Seller's possession or control.

9. **Special Tooling.** Special Tooling includes but is not limited to tooling, jigs, fixtures and associated manufacturing equipment acquired or necessary to manufacture Products. A tooling charge may be imposed for any Special Tooling. Such Special Tooling shall be and remain Seller's property notwithstanding payment of any charges by Buyer. In no event will Buyer acquire any interest in Special Tooling belonging to Seller that is utilized in the manufacture of the Products, even if such Special Tooling has been specially converted or adapted for such manufacture and notwithstanding any charges paid by Buyer. Unless otherwise agreed, Seller has the right to alter, discard or otherwise dispose of any Special Tooling or other property in its sole discretion at any time.

10. **Security Interest.** To secure payment of all sums due, Seller retains a security interest in all Products delivered to Buyer and, Buyer's acceptance of these Terms is deemed to be a Security Agreement under the Uniform Commercial Code. Buyer authorizes Seller as its attorney to execute and file on Buyer's behalf all documents Seller deems necessary to perfect its security interest.

11. **User Responsibility.** The Buyer through its own analysis and testing, is solely responsible for making the final selection of the Products and assuring that all performance, endurance, maintenance, safety and warning requirements of the application of the Products are met. The Buyer must analyze all aspects of the application and follow applicable industry standards, specifications, and other technical information provided with the Product. If Seller provides Product options based upon data or specifications provided by the Buyer, the Buyer is responsible for determining that such data and specifications are suitable and sufficient for all applications and reasonably foreseeable uses of the Products. In the event the Buyer is not the end-user, Buyer will ensure such end-user complies with this paragraph.

12. **Use of Products; Indemnity by Buyer.** Buyer shall comply with all instructions, guides and specifications provided by Seller with the Products. **Unauthorized Uses.** If Buyer uses or resells the Products for any uses prohibited in Seller's instructions, guides or specifications, or Buyer otherwise fails to comply with Seller's instructions, guides and specifications, Buyer acknowledges that any such use, resale, or non-compliance is at Buyer's sole risk. Buyer shall indemnify, defend, and hold Seller harmless from any losses, claims, liabilities, damages, lawsuits, judgments and costs (including attorney fees and defense costs), whether for personal injury, property damage, intellectual property infringement or any other claim, brought by or incurred by Buyer, Buyer's employees, or any other person, arising out of: (a) improper selection, application, design, specification or other misuse of Products provided by Seller; (b) any act or omission, negligent or otherwise, of Buyer; (c) Seller's use of patterns, tooling, equipment, plans, drawings, designs or specifications or other information or things furnished by Buyer; (d) damage to the Products from an external cause, repair or attempted repair by anyone other than Seller, failure to follow instructions, guides and specifications provided by Seller, use with goods not provided by Seller, or opening, modifying, deconstructing or tampering with the Products for any reason; or (e) Buyer's failure to comply with these Terms. Seller shall not indemnify Buyer under any circumstance except as otherwise provided in these Terms.

13. **Cancellations and Changes.** Buyer may not cancel or modify any order for any reason, except with Seller's written consent and upon terms that will indemnify, defend and hold Seller harmless against all direct, incidental and consequential loss or damage. Seller, at any time, may change Product features, specifications, designs and availability.

14. **Limitation on Assignment.** Buyer may not assign its rights or obligations without the prior written consent of Seller.

15. **Force Majeure.** Seller does not assume the risk and is not liable for delay or failure to perform any of Seller's obligations by reason of events or circumstances beyond its reasonable control ("Events of Force Majeure"). Events of Force Majeure shall include without limitation: accidents, strikes or labor disputes, acts of any government or government agency, acts of nature, delays or failures in delivery from carriers or suppliers, shortages of materials, or any other cause beyond Seller's reasonable control.

16. **Waiver and Severability.** Failure to enforce any provision of these Terms will not invalidate that provision; nor will any such failure prejudice Seller's right to enforce that provision in the future. Invalidation of any provision of these Terms by legislation or other rule of law shall not invalidate any other provision herein and, the remaining provisions will remain in full force and effect.

17. **Termination.** Seller may terminate any agreement governed by or arising from these Terms for any reason and at any time by giving Buyer thirty (30) days prior written notice. Seller may immediately terminate, in writing, if Buyer: (a) breaches any provision of these Terms (b) appoints a trustee, receiver or custodian for all or any part of Buyer's property (c) files a petition for relief in bankruptcy on its own behalf, or one filed by a third party (d) makes an assignment for the benefit of creditors; or (e) dissolves its business or liquidates all or a majority of its assets.

18. **Ownership of Software.** Seller retains ownership of all Software supplied to Buyer hereunder. In no event shall Buyer obtain any greater right in and to the Software than a right in the nature of a license limited to the use thereof and subject to compliance with any other terms provided with the Software.

19. **Indemnity for Infringement of Intellectual Property Rights.** Seller is not liable for infringement of any patents, trademarks, copyrights, trade dress, trade secrets or similar rights ("Intellectual Property Rights") except as provided in this Section. Seller will defend at its expense and will pay the cost of any settlement or damages awarded in an action brought against Buyer based on a third party claim that one or more of the Products sold hereunder infringes the Intellectual Property Rights of a third party in the country of delivery of the Products by the Seller to the Buyer. Seller's obligation to defend and indemnify Buyer is contingent on Buyer notifying Seller within ten (10) days after Buyer becomes aware of any such claim, and Seller having sole control over the defense of the claim including all negotiations for settlement or compromise. If one or more Products sold hereunder is subject to such a claim, Seller may, at its sole expense and option, procure for Buyer the right to continue using the Products, replace or modify the Products so as to render them non-infringing, or offer to accept return of the Products and refund the purchase price less a reasonable allowance for depreciation. Seller has no obligation or liability for any claim of infringement: (i) arising from information provided by Buyer; or (ii) directed to any Products provided hereunder for which the designs are specified in whole or part by Buyer; or (iii) resulting from the modification, combination or use in a system of any Products provided hereunder. The foregoing provisions of this Section constitute Seller's sole and exclusive liability and Buyer's sole and exclusive remedy for such claims of infringement of Intellectual Property Rights.

20. **Governing Law.** These Terms and the sale and delivery of all Products are deemed to have taken place in, and shall be governed and construed in accordance with, the laws of the State of Ohio, as applicable to contracts executed and wholly performed therein and without regard to conflicts of laws principles. Buyer irrevocably agrees and consents to the exclusive jurisdiction and venue of the courts of Cuyahoga County, Ohio with respect to any dispute, controversy or claim arising out of or relating to the sale and delivery of the Products.

21. **Entire Agreement.** These Terms, along with the terms set forth in the main body of any Quote, forms the entire agreement between the Buyer and Seller and constitutes the final, complete and exclusive expression of the terms of sale. In the event of a conflict between any term set forth in the main body of a Quote and these Terms, the terms set forth in the main body of the Quote shall prevail. All prior or contemporaneous written or oral agreements or negotiations with respect to the subject matter shall have no effect. These Terms may not be modified unless in writing and signed by an authorized representative of Seller.

22. **Compliance with Laws.** Buyer agrees to comply with all applicable laws, regulations, and industry and professional standards, including those of the United States of America, and the country or countries in which Buyer may operate, including without limitation the U.S. Foreign Corrupt Practices Act ("FCPA"), the U.S. Anti-Kickback Act ("Anti-Kickback Act"), U.S. and E.U. export control and sanctions laws ("Export Laws"), the U.S. Food Drug and Cosmetic Act ("FDCA"), and the rules and regulations promulgated by the U.S. Food and Drug Administration ("FDA"), each as currently amended. Buyer agrees to indemnify, defend, and hold harmless Seller from the consequences of any violation of such laws, regulations and standards by Buyer, its employees or agents. Buyer acknowledges that it is familiar with all applicable provisions of the FCPA, the Anti-Kickback Act, Export Laws, the FDCA and the FDA and certifies that Buyer will adhere to the requirements thereof and not take any action that would make Seller violate such requirements. Buyer represents and agrees that Buyer will not make any payment or give anything of value, directly or indirectly, to any governmental official, foreign political party or official thereof, candidate for foreign political office, or commercial entity or person, for any improper purpose, including the purpose of influencing such person to purchase Products or otherwise benefit the business of Seller. Buyer further represents and agrees that it will not receive, use, service, transfer or ship any Product from Seller in a manner or for a purpose that violates Export Laws or would cause Seller to be in violation of Export Laws.