

- > 2x3/2, 5/2 and 5/3 valves, ISO 15407-1/VDMA 24 563, Size 18 mm
- > Solenoid and pilot actuated
- > High performance, compact design
- > Flexible sub-base system
- > Multipressure system capability
- > Dual spool technology:
 - V40 Glandless spool and sleeve (long life)
 - V41 Softseal spool (high flow)
- > Collected pilot exhaust with internal pilot air supply
- > Easy to convert from internal to external pilot supply
- > Valve exchange under pressure

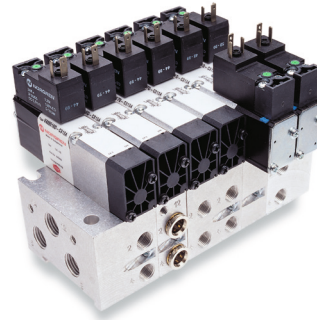

Technical features

Medium:

Compressed air, filtered to 40 µm, lubricated or non-lubricated

Operation:

V40: Glandless spool valve, solenoid pilot or air pilot actuated
 V41: Softseal spool valve, solenoid pilot or air pilot actuated

Flow:

V41 Softseal:				
Function	l/min	Cv	Kv	
2x3/2	610	0,62	0,53	
5/2	650	0,66	0,57	
5/3	680	0,69	0,59	
V40 Glandless:				
Function	l/min	Cv	Kv	
5/2	570	0,58	0,50	
5/3	610	0,62	0,53	

Mounting:

Sub-base

Operating pressure:

Maximum pressure
 10 bar (145 psi) V41 models and V40 solenoid pilot actuated valves with internal pilot supply
 16 bar (232 psi) V40 solenoid pilot actuated valves w. ext. pilot supply and V40 air pilot actuated valves
 Details of minimum and maximum pilot pressure see overleaf

Media/Ambient temperature:

-15 ... +50°C (+5 ... 122°F)
 V40/V41 solenoid and V41 air pilot models
 -15 ... +80°C (+5 ... 176°F)
 V40 air pilot models
 Air supply must be dry enough to avoid ice formation at temperatures below +2°C (+35°F).



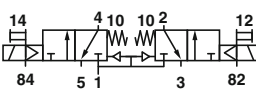
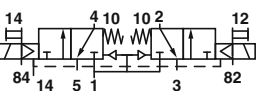
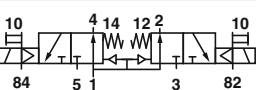
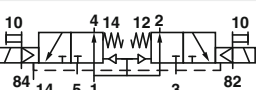
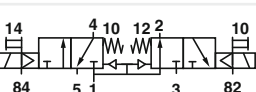
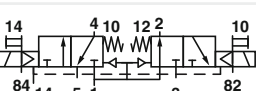

Materials:

Body: die-cast aluminium
 Sub-base: aluminium alloy
 Spool and sleeve: hard anodized, Teflon coated, matched aluminium (V40) or aluminium alloy spool (V41) with HNBR seals
 Plastic parts: POM
 Static seals: NBR
 End cover and screws: zinc plated
 Springs: stainless steel

2 x 3/2 Solenoid pilot actuated softseal valves

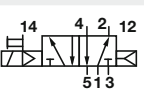
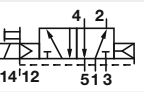
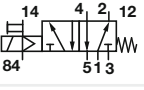
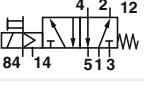
Symbol	Function 2 x 3/2	Actuation/ return	Pilot supply	Pilot exhaust	Operating pressure (bar)	Pilot pressure (bar)	Flow (l/min)	Model
	NC	Solenoid/Spring	Internal	Collected #	2,5 ... 10	–	610	V415A11D-*1)
	NC	Solenoid/Spring	External	Not collected	0 ... 10	1,7 + (0,35 x operating pressure)	610	V415A22D-*1)
	NO	Solenoid/Spring	Internal	Collected #	2,5 ... 10	–	610	V415B11D-*1)
	NO	Solenoid/Spring	External	Not collected	0 ... 10	1,7 + (0,35 x operating pressure)	610	V415B22D-*1)
	NO/NC	Solenoid/Spring	Internal	Collected #	2,5 ... 10	–	610	V415C11D-*1)
	NO/NC	Solenoid/Spring	External	Not collected	0 ... 10	1,7 + (0,35 x operating pressure)	610	V415C22D-*1)

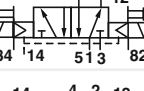
5/2 Solenoid pilot actuated glandless and softseal valves

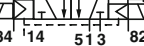
Symbol	Pilot supply	Pilot exhaust	Operator 14	Operator 12	Operating pressure (bar)	Pilot pressure (bar)	Sealing system	Flow (l/min)	Model
	Internal	Collected #	Solenoid	Air spring	1 ... 10	–	Glandless	570	V405513D-*1)
	Internal	Collected #	Solenoid	Air spring	1 ... 10	–	Soft seal	650	V415513D-*1)
	External	Not collected	Solenoid	Air spring	-0,9 ... 16	1 ... 10	Glandless	570	V405523D-*1)
	External	Not collected	Solenoid	Air spring	-0,9 ... 10	1 ... 10	Soft seal	650	V415523D-*1)
	Internal	Collected #	Solenoid	Spring & air spring	1,6 ... 10	–	Glandless	570	V405516D-*1)
	Internal	Collected #	Solenoid	Spring	2 ... 10	–	Soft seal	650	V415517D-*1)
	External	Not collected	Solenoid	Spring & air spring	-0,9 ... 16	1,6 ... 10	Glandless	570	V405526D-*1)
	External	Not collected	Solenoid	Spring	-0,9 ... 10	2 ... 10	Soft seal	650	V415527D-*1)
	Internal	Collected #	Solenoid	Solenoid	2 ... 10	–	Glandless	570	V405511D-*1)
	Internal	Collected #	Solenoid	Solenoid	2 ... 10	–	Soft seal	650	V415511D-*1)
	External	Not collected	Solenoid	Solenoid	-0,9 ... 16	2 ... 10	Glandless	570	V405522D-*1)
	External	Not collected	Solenoid	Solenoid	-0,9 ... 10	2 ... 10	Soft seal	650	V415522D-*1)
	Internal	Collected #	Solenoid (priority)	Solenoid	2 ... 10	–	Glandless	570	V405591D-*1)
	External	Not collected	Solenoid (priority)	Solenoid	-0,9 ... 16	2 ... 10	Glandless	570	V405592D-*1)

*1) Insert voltage code from tables on page 3

Pilot exhaust collected and exhausted via port 14

NO = Normally open, NC = Normally closed

5/3 Solenoid pilot actuated glandless and softseal valves

Symbol	Function	Pilot supply	Pilot exhaust	Operator 14	Operator 12	Operating pressure (bar)	Pilot pressure (bar)	Sealing system	Flow (l/min)	Model
	APB	Internal	Collected #	Solenoid	Solenoid	2 ... 10	–	Glandless	610	V405611D-*1)
	APB	Internal	Collected #	Solenoid	Solenoid	2 ... 10	–	Soft seal	680	V415611D-*1)
	APB	External	Not collected	Solenoid	Solenoid	-0,9 ... 16	2 ... 10	Glandless	610	V405622D-*1)
	APB	External	Not collected	Solenoid	Solenoid	-0,9 ... 10	2 ... 10	Soft seal	680	V415622D-*1)
	COE	Internal	Collected #	Solenoid	Solenoid	2 ... 10	–	Glandless	610	V405711D-*1)
	COE	Internal	Collected #	Solenoid	Solenoid	2,5 ... 10	–	Soft seal	680	V415711D-*1)
	COE	External	Not collected	Solenoid	Solenoid	-0,9 ... 16	2 ... 10	Glandless	610	V405722D-*1)
	COE	External	Not collected	Solenoid	Solenoid	-0,9 ... 10	2,5 ... 10	Soft seal	680	V415722D-*1)
	COP	Internal	Collected #	Solenoid	Solenoid	2 ... 10	–	Glandless	610	V405811D-*1)
	COP	Internal	Collected #	Solenoid	Solenoid	2 ... 10	–	Soft seal	680	V415811D-*1)
	COP	External	Not collected	Solenoid	Solenoid	-0,9 ... 16	2 ... 10	Glandless	610	V405822D-*1)
	COP	External	Not collected	Solenoid	Solenoid	-0,9 ... 10	2 ... 10	Soft seal	680	V415822D-*1)

*1) Insert voltage code from tables below

Pilot exhaust collected and exhausted via port 14

APB = All Ports Blocked COE = Centre Open Exhaust COP = Centre open pressure

Electrical details for solenoid operators

Voltage tolerances	-10%/+15%
Rating	100 % Continuous duty
Inlet orifice	0,8 mm
Electrical connection	15 mm DIN EN 175301-803 (DIN 43 650) Table C
Manual override	Shrouded push button, spring return Convertible into lockable type with set-up kit, part no. V70532-K00 (see next page)
Protection class	IP 65 with sealed plug (ISO 6952) NEMA 4
Materials	PPS (body), FPM and NBR (seal)

Intrinsically safe version available on request.

Voltage codes & spare pilots

Voltage	Coil code	Current	Spare pilot valve
12 V d.c.	C312A	1 W	VZC7L2C1-C312A
24 V d.c.	C313A	1,2 W	VZC7L2C1-C313A
24 V 50/60 Hz.	C314A	2,1/1,5 VA	VZC7L2C1-C314A
48 V 50/60 Hz	C316A	2,1/1,5 VA	VZC7L2C1-C316A
110 V d.c.	C317A	1 W	VZC7L2C1-C317A
115 V 50/60 Hz	C318A	2,1/1,5 VA	VZC7L2C1-C318A
230 V 50/60 Hz	C319A	2,1/1,5 VA	VZC7L2C1-C319A

Other voltages available on request. Spare pilot valves are delivered with mounting screws.

2 x 3/2 Air pilot actuated softseal valves

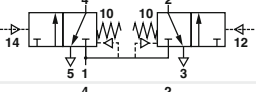
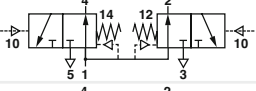
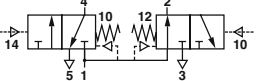
Symbol	Function 2 x 3/2	Actuation/return 2 x 3/2	Operating pressure (bar)	Pilot pressure (bar)	Sealing system	Flow (l/min)	Model
	NC	Air/Spring	0 ... 10	1,7 + (0,35 x operating pressure)	Soft seal	610	V415A33A-X0020
	NO	Air/Spring	0 ... 10	1,7 + (0,35 x operating pressure)	Soft seal	610	V415B33A-X0020
	NO/NC	Air/Spring	0 ... 10	1,7 + (0,35 x operating pressure)	Soft seal	610	V415C33A-X0020

5/2 Air pilot actuated glandless and softseal valves

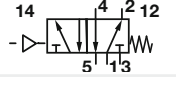
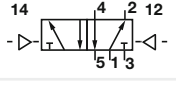
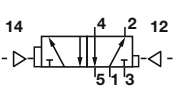
Symbol	Operator 14	Operator 12	Operating pressure (bar)	Pilot pressure (bar)	Sealing system	Flow (l/min)	Model
	Air	Spring	-0,9 ... 16	1,6 ... 16	Glandless	570	V405537A-X0090
	Air	Spring	-0,9 ... 10	2 ... 10	Soft seal	610	V415537A-X0090
	Air	Air	-0,9 ... 16	2 ... 16	Glandless	570	V405533A-X0020
	Air	Air	-0,9 ... 10	2 ... 10	Soft seal	610	V415533A-X0020
	Air (priority)	Air	-0,9 ... 16	2 ... 16	Glandless	570	V405533A-X0070



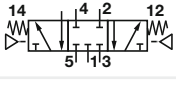
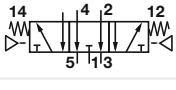
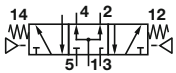



5/3 Air pilot actuated glandless and softseal valves

Symbol	Function	Operator 14	Operator 12	Operating pressure (bar)	Pilot pressure (bar)	Sealing system	Flow (l/min)	Model
	APB	Air	Air	-0,9 ... 16	2 ... 16	Glandless	610	V405633A-X0020
	APB	Air	Air	-0,9 ... 10	2 ... 10	Soft seal	680	V415633A-X0020
	COE	Air	Air	-0,9 ... 16	2 ... 16	Glandless	610	V405733A-X0020
	COE	Air	Air	-0,9 ... 10	2,5 ... 16	Soft seal	680	V415733A-X0020
	COP	Air	Air	-0,9 ... 16	2 ... 16	Glandless	610	V405833A-X0020
	COP	Air	Air	-0,9 ... 10	2 ... 10	Soft seal	680	V415833A-X0020

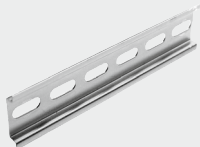
Valve function: NO = Normally open, NC = Normally closed

APB = All Ports Blocked, COE = Centre Open Exhaust, COP = Centre Open Pressure

Accessories







DIN EN 50 022 rail (1 m)	DIN-rail mounting kit	Blanking disc to modular sub-base	Manual override set-up kit	Blanking plate for unused station	Transition plate V40/V41 » V44/V45
					
V10009-C00 (35 x 7,5 mm) V10592-C01 (35 x 15 mm)	V70531-KA0	V70422-K50 (Ports 1,3,5) V70423-K50 (Ports 12 & 14)	V70532-K00	V70400-K50	Page 11 V70436-K00 V70436-B00 *1)

*1) With supply and exhaust ports





Blanking Plug for Fixed Length Sub-base

V70421-K50 (Ports 1, 3, 5)

Sandwich plates

Intermediate supply/exhaust manifold	Single valve shut-off plate	Single pressure regulator plate	Double pressure regulator plate	Flow regulator plate	Sandwich plate with additional pressure port 1
					
Page 10 V70429-A50 (G1/8) V70429-P50 (1/8 NPTF)	Page 10 V70430-K50 (Port 1 blocked)	Page 12 & 13 V70427-K51 (Port 1 reg.) V70427-K52 (Port 2 reg.) V70427-K53 (Port 4 reg.)	Page 13 V70427-K54 (Ports 2+4 reg.)	Page 10 V70428-K50 (Ports 3+5 reg.)	Page 11 V70435-A50 (G1/8) V70435-P50 (1/8NPTF)

Sub-bases and end plates

Single station sub-base	Double station modular sub-base	Single station modular sub-base	End plate kit	Fixed length sub-base
				
Page 7	Page 8 & 9	Page 8 & 9	Page 8 & 9	Page 9

Connector plug - ordered separately

I15 mm DIN EN 175301-803
(DIN 43 650) Table C



V10027-D00
250 V a.c./300 V d.c.

Valve dimensions

V4155*3D-C3***
5/2 Single solenoid pilot valve
Air spring return

V4055D-C3*****
5/2 Single solenoid pilot valve
Mechanical (& air) spring valve

Dimensions in mm
Projection/First angle

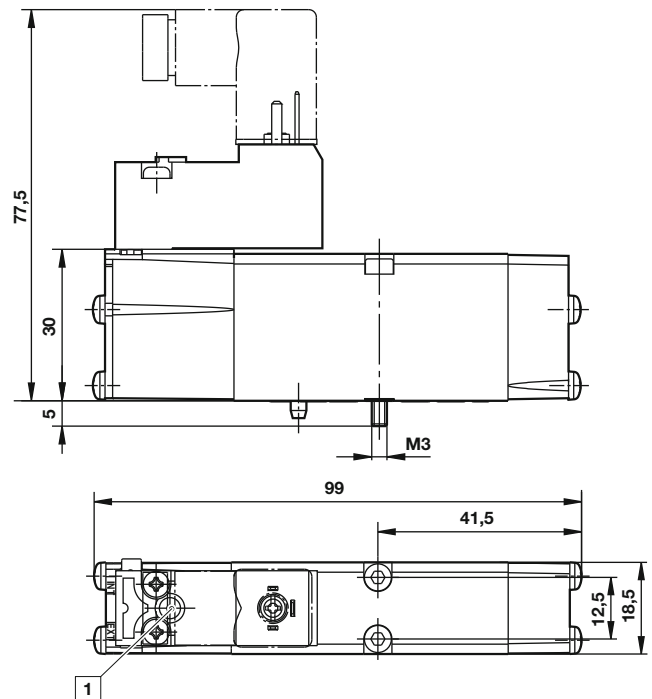
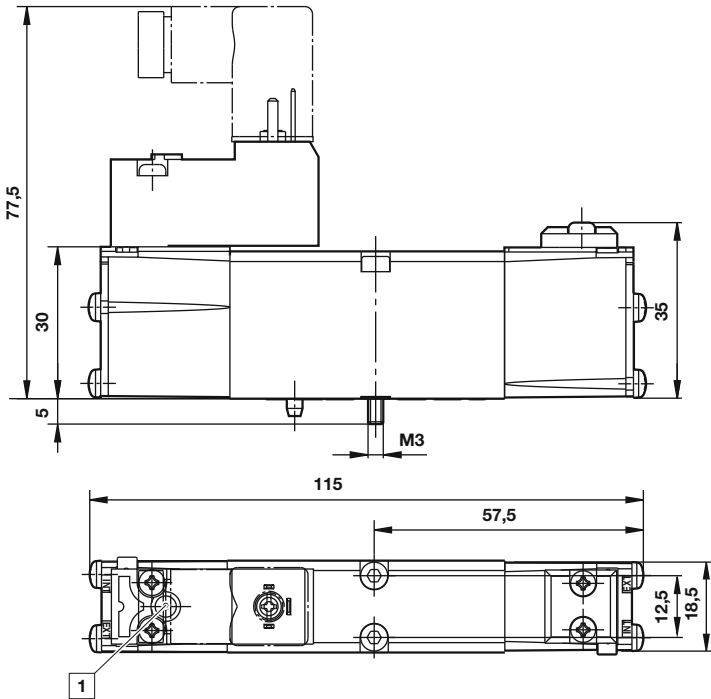

V4055D-C3*** & V4155**D-C3*****
5/2 Double solenoid pilot valve
V405*D-C3*** & V415***D-C3*****
2x3/2 + 5/3 Double solenoid pilot valve

 Manual override

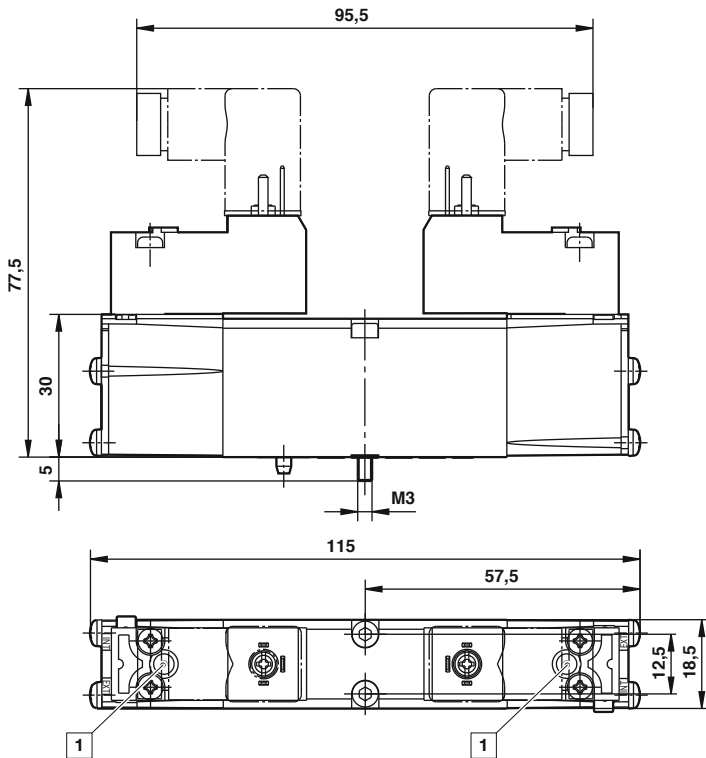

V415537A-X0090
5/2 Single air pilot valve

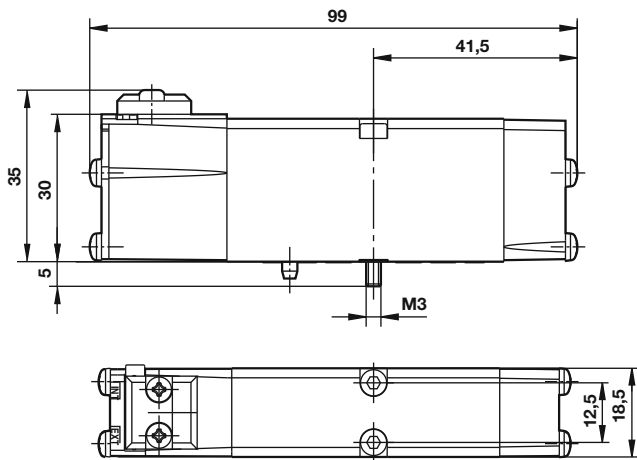

V405537A-X0090
5/2 Single air pilot valve
V405*33A-X00*0 & V415*33A-X00*0
2x3/2, 5/2 + 5/3 Double air pilot valve

Dimensions in mm
Projection/First angle

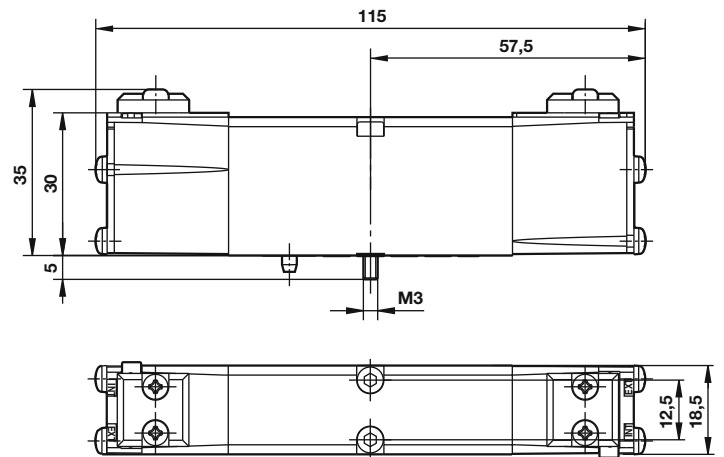

Single station sub-base – side ported with pilot ports

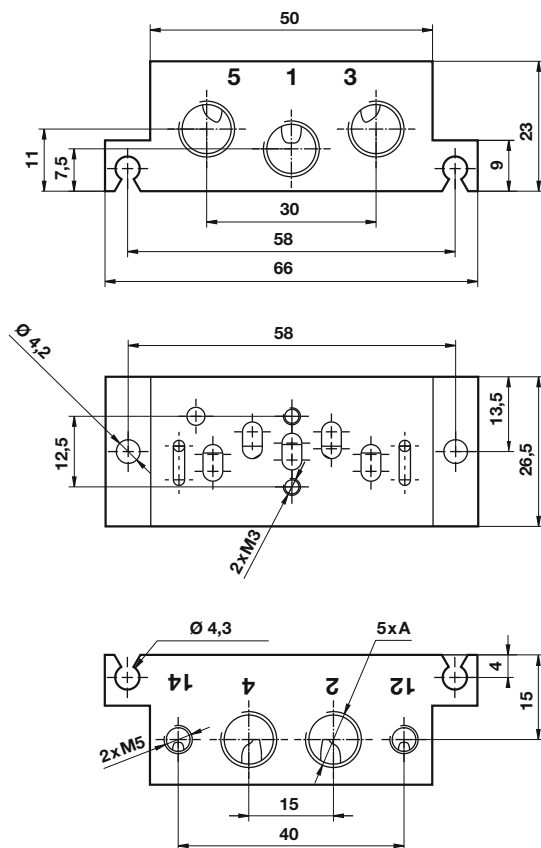

Port size A	Model
G1/8 side ported with pilot ports	V70401-A5B

Note: Pilot ports = M5

Side ported sub-base

Dimensions in mm
Projection/First angle

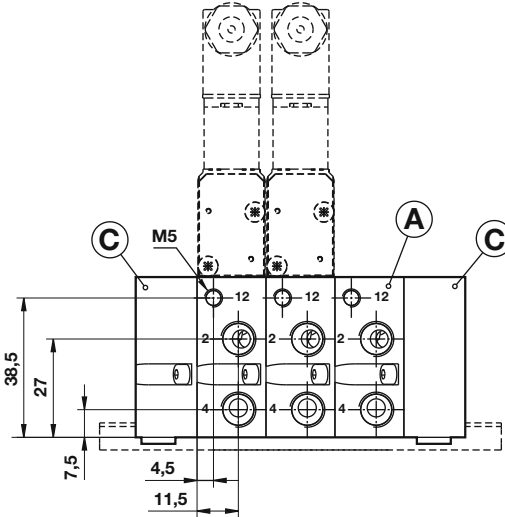
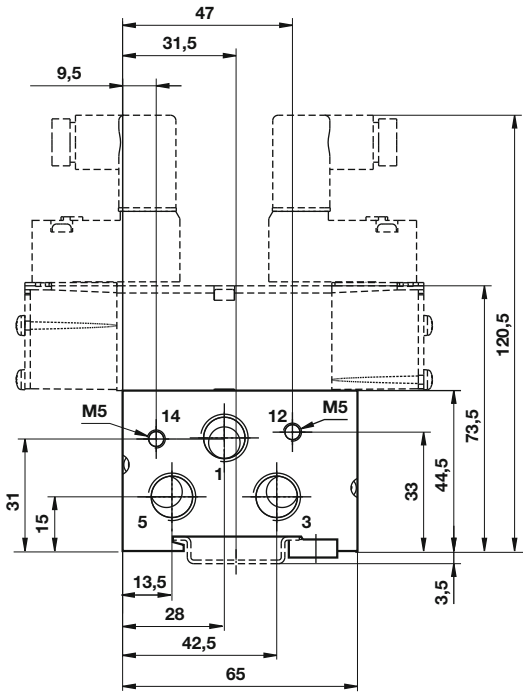

Bottom and side ported sub-base

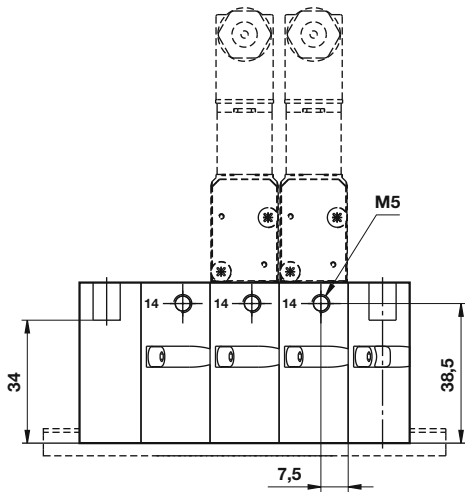

N = number of stations
x/y = Insert port type from table below

- 1 Right hand side
- 2 Left hand side

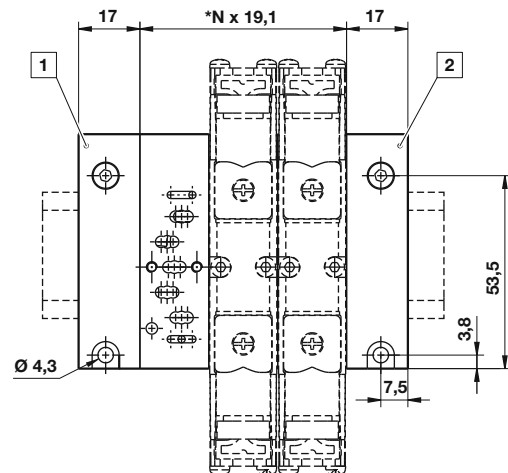

Code x	Code y	Ports 2 & 4	Ports
A	A	G1/8	M5
P	P	1/8 NPTF	M5
8	-	Ø 8 mm PIF	M5
6	-	Ø 6 mm PIF	M5
1	-	Ø 1/4" PIF	M5

Modular sub-bases parts for DIN rail or surface mounting
Bottom ported sub-base

Dimensions in mm
Projection/First angle

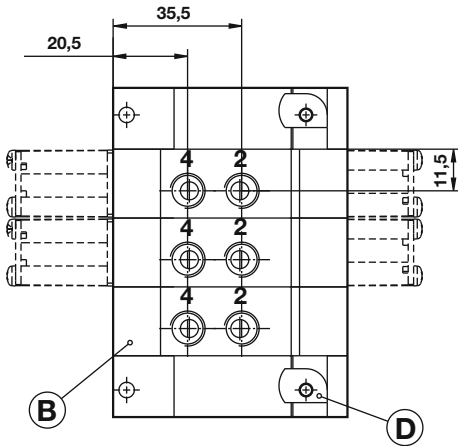

Note: Port 14 either used for external pilot air supply or for collected pilot air exhaust. Therefore, never plug port 14 when using valves with internal pilot air supply. Port 12 is not used, plugging not necessary.

Individual components

Modular sub-base (A)	Ports 2+4 on side	V70425-x5F		
Double station modular sub-base (A)	Ports 2+4 on side	V70432-y5F		
Modular sub-base (A)	Ports 2+4 on side	Pilot ports 12+14 on side	V70426-x5F	
Modular sub-base (B)	Ports 2+4 on bottom	V70425-A5E		
Modular sub-base (B)	Ports 2+4 on bottom	Pilot ports 12+14 on side	V70426-A5E	
End plate kit (C)	End ported	V70424-B5C (G1/4)	V70424-R5C (1/4NPTF)	End ported end caps 1 left hand and 1 right hand
		V70431-A5F (1/3/5 G1/4, 2/4 G1/8)	V70431-P5F (1/3/5 1/4NPTF, 2/4 1/8NPTF)	End ported end caps 1 left and 1 right

Accessories

DIN EN 50022 rail	35 x 7,5 mm, 1m	V10009-C00
DIN EN 50022 rail	35 x 15 mm, 1m	V10592-C01
DIN rail (D)	Mounting kit	V70531-KA0
Blanking disk to modular sub-base	Ports 1, 3, 5	V70422-K50
Blanking disk to modular sub-base	Ports 12+14	V70423-K50

Fixed length sub-base - bottom ported

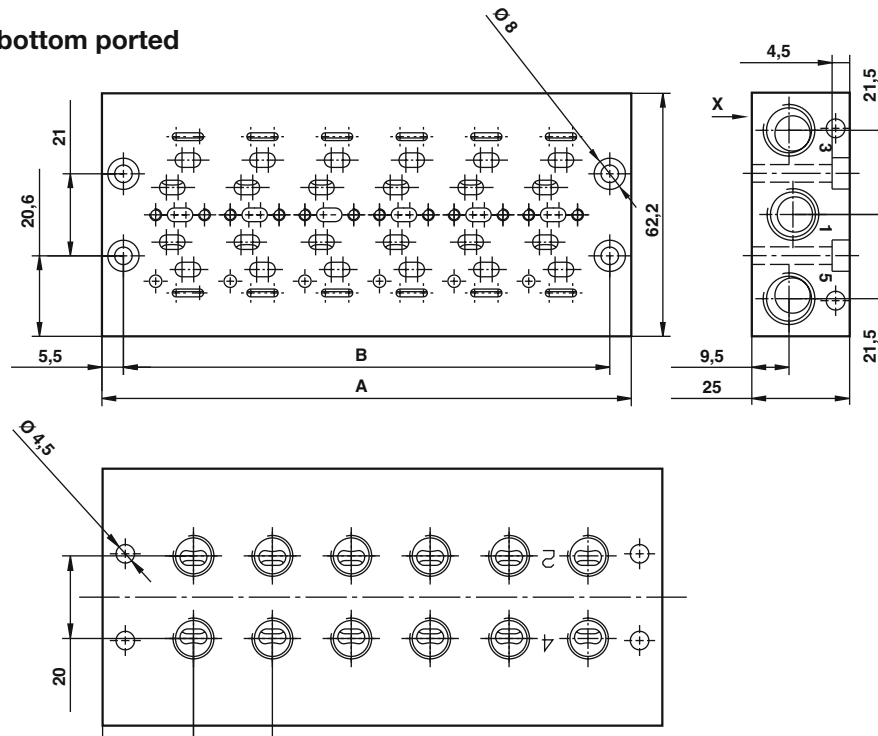

Number of stations	A	B	Ports 2 & 4	Ports 1, 3 & 5	Model
2	59,1	48,1	G1/8	G1/4	V70402-A50
4	97,3	86,3	G1/8	G1/4	V70404-A50
6	135,5	124,5	G1/8	G1/4	V70406-A50
8	173,7	162,7	G1/8	G1/4	V70408-A50
10	211,9	200,9	G1/8	G1/4	V70410-A50
12	250,1	239,1	G1/8	G1/4	V70412-A50

Note: This sub-base is suitable for solenoid pilot actuated valves with internal pilot air supply only

Intermediate supply/exhaust manifold

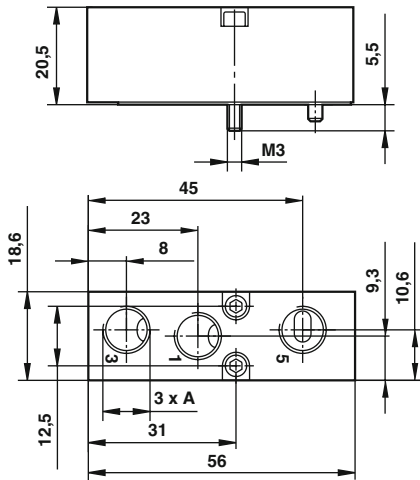

Port size A	Model
G1/8	V70429-A50

Provides additional porting on modular- or fixed length sub-base.
Occupies one valve station. Supplied with gasket for both sub-bases.

Can be used to:

- Improve supply flow
- Increase exhaust capacity
- Pneumatically separate valves for fail-safe emergency
- Multipressure system and system solutions

Single valve shut-off plate

Dimensions in mm
Projection/First angle

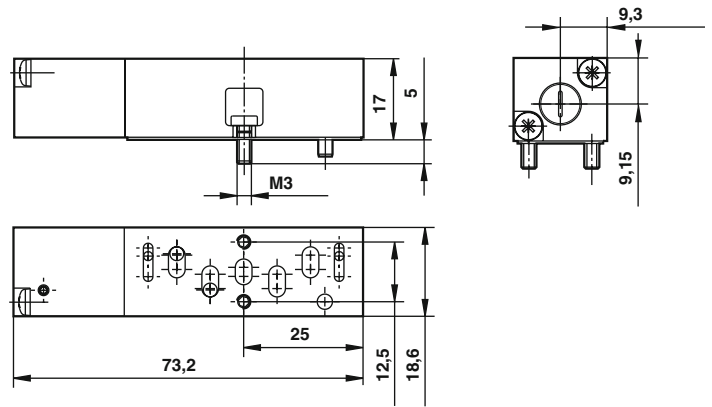

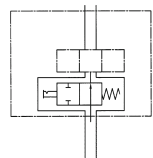
Symbol	Description	Model
	Single shut-off plate supplied with gasket	V70430-K50

Allows individual exchange of valve, while valve island is pressurised by port 1.

Note: Flow restricted to max. 240 l/min.

Flow characteristics for pressure regulator plates

Dual regulation of exhaust ports 3 & 5

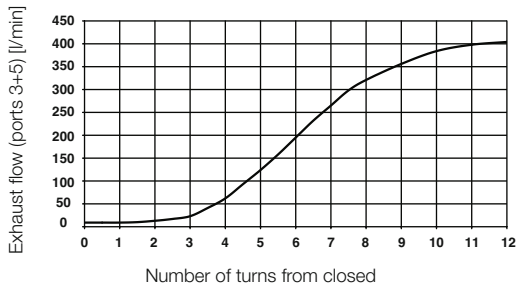

Flow: Port 1 > 2 & 1 > 4: remains unchanged

Flow measured at 6 bar inlet, pressure drop 1 bar

Flow regulator plate

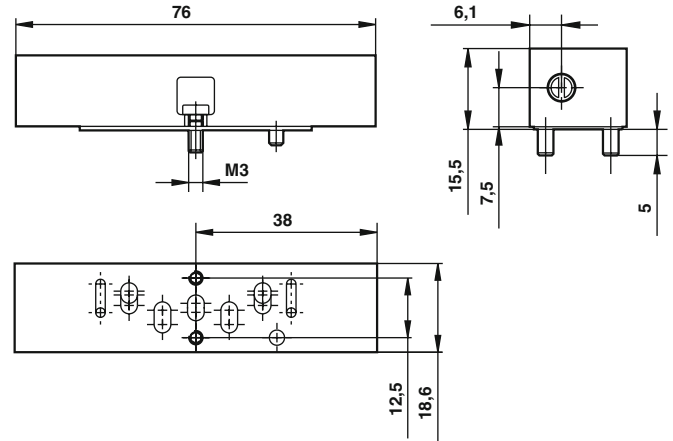

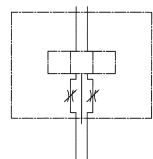
Symbol	Description	Model
	Flow regulator supplied with gasket	V70428-K50

Sandwich plate with additional pressure port 1
Blanking plate

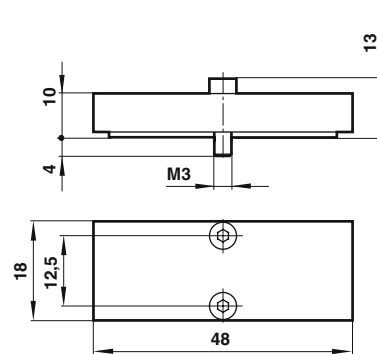
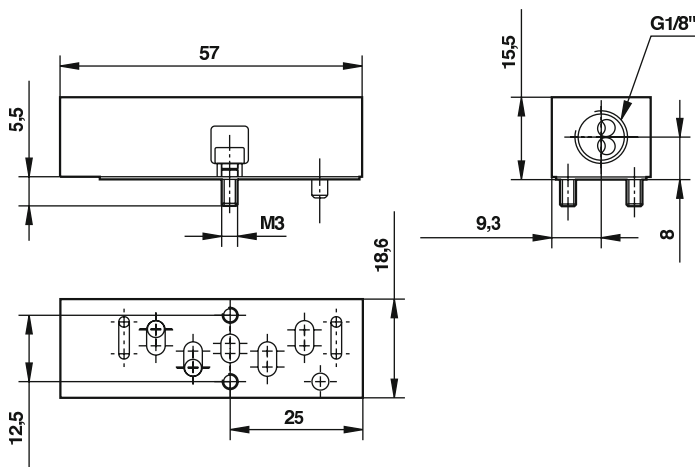
 Dimensions in mm
 Projection/First angle

Description

Sandwich plate with additional port 1 G1/8, supplied with gasket

Model

V70435-A50

Description

Blanking plate for blocking of unused stations (supplied with gasket)

Model

V70400-K50

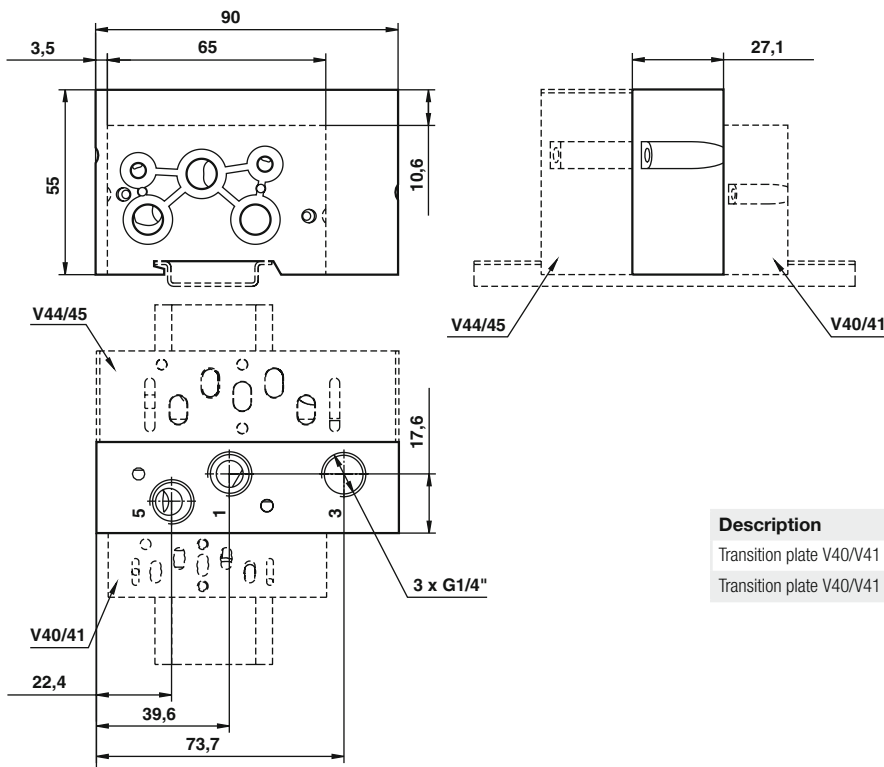
Transition plate #18 mm > #26 mm

Description

Transition plate V40/V41 » V44/V45 Without port 1/3/5

Model

V70436-K00

Transition plate V40/V41 » V44/V45 with supply/exhaust ports G1/4

V70436-B00

Flow characteristics for pressure regulator plates

Inlet pressure = 8 bar

Dimensions in mm
Projection/First angle

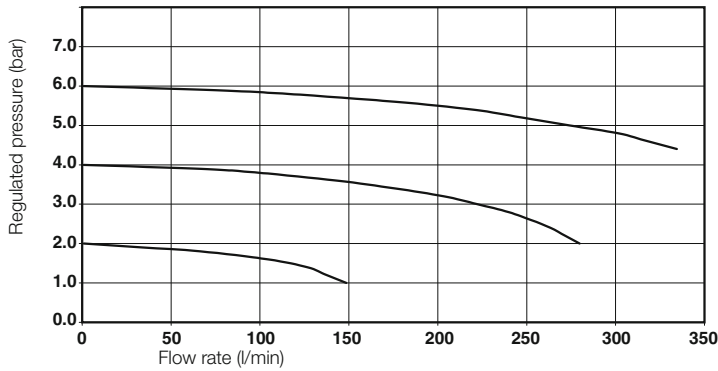

Pressure regulator plates (including gauge and adaptor tube)

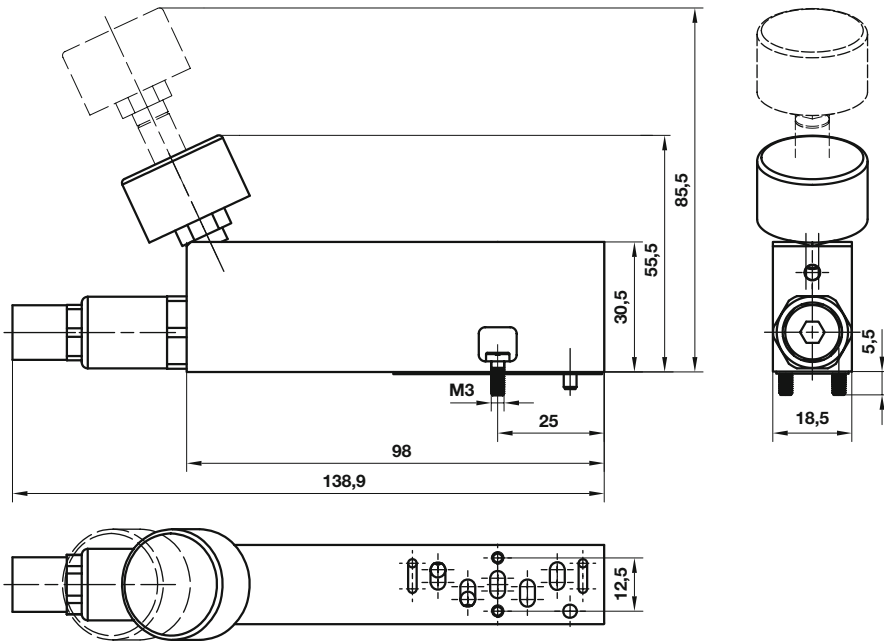

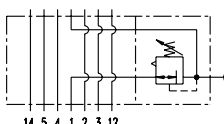
Symbol	Description	Model
	Regulation of port 1	V70427-K51

Maximum inlet pressure 16 bar. Regulated pressure 1 ... 10 bar

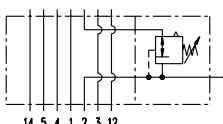
Symbol	Description	Model
	Regulation of port 2	V70427-K52

Maximum inlet pressure 16 bar. Regulated pressure 1 ... 10 bar

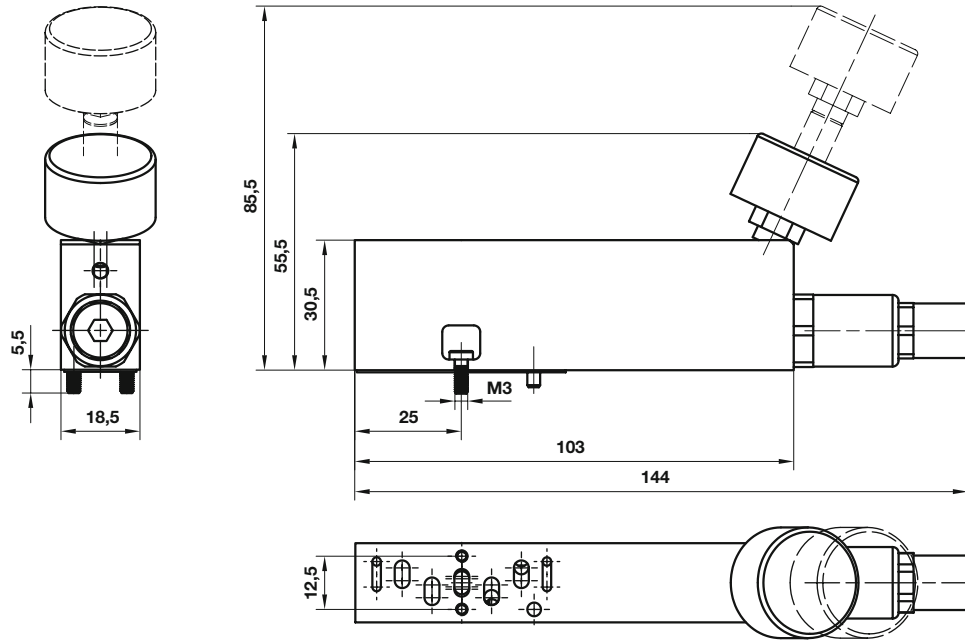
Dimensions in mm
 Projection/First angle

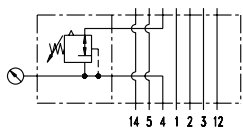
Symbol	Description	Model
	Regulation of port 4	V70427-K53

Maximum inlet pressure 16 bar. Regulated pressure 1 ... 10 bar

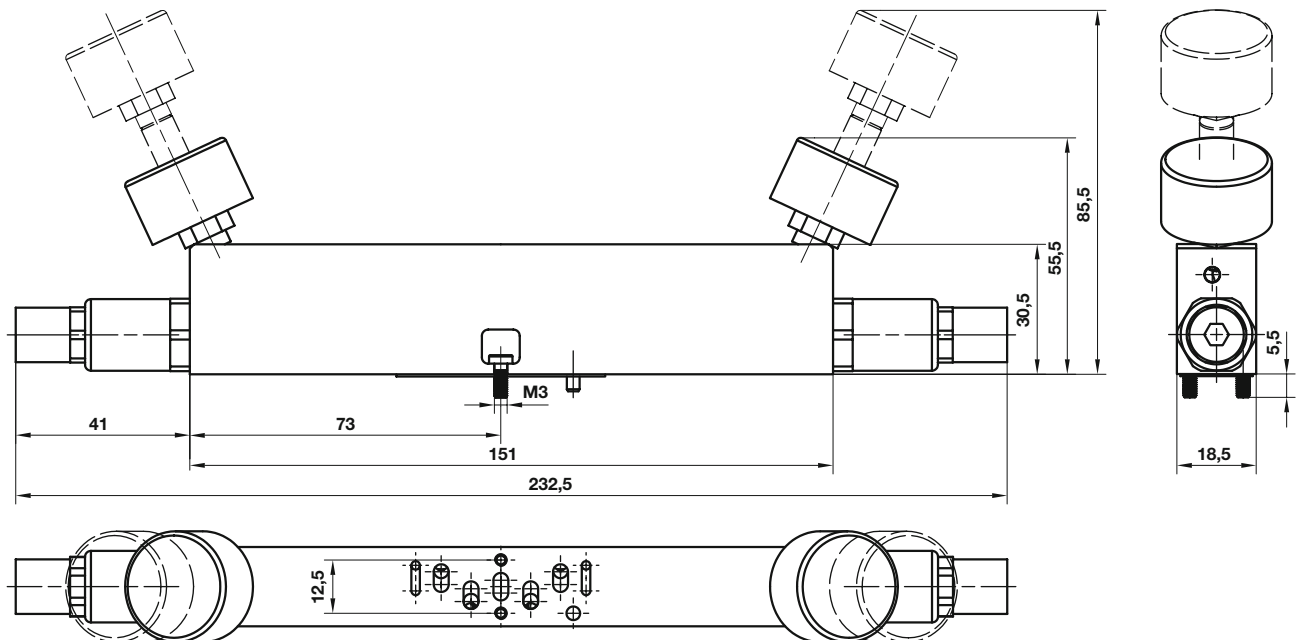

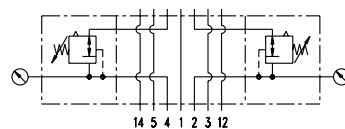
Symbol	Description	Model
	Regulation of ports 2+4	V70427-K54

Maximum inlet pressure 16 bar. Regulated pressure 1 ... 10 bar

Conversion from internal to external pilot supply / Collected pilot exhaust

The lowered and captive gasket between valve body and pilot valve defines and indicates pilot air supply as well as pilot exhaust function of the valve.

Solenoid pilot actuated valves

Drawing shows no pilot valve.

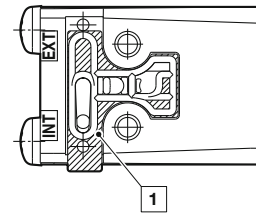
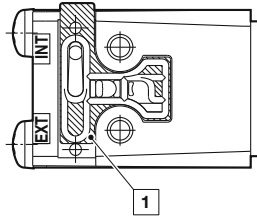

1 Blue gasket

Internal pilot supply, pilot exhaust air collected and exhausted via port 14.

All solenoid pilot valves with code 1 at position 6 in the part number (e.g V41551...) have the gasket mounted in this position on delivery.

External pilot supply from port 14 only, pilot exhaust air not collected but bleed through valve body.

All solenoid pilot valves with code 2 at position 6 in the part number (e.g V41552...) have the gasket mounted in this position on delivery.

Note: Dismounting pilot valve gives access to gasket. Conversion from internal to external pilot supply (or vice versa) by turning the gasket.

Caution: In this case part number and symbol on label shows different function. Therefore check gasket position when mounting valve.

V40-5/2 Solenoid pilot actuated valves with air spring return

Additional to above described work, gasket between end cap and valve body must be turned too at valves with this function. For detailed instructions see Installation- and Maintenance Sheet.

V41-5/2 Solenoid pilot actuated valves with air spring return

Additional to above described work, gasket between cover plate and end cap must be turned too at valves with this function. For detailed instructions see Installation- and Maintenance Sheet.



Drawing shows end cap side 12.

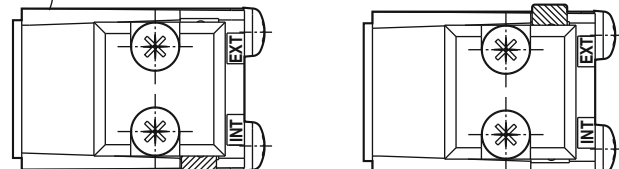

Drawing shows end cap side 12.

Air pilot actuated valves

Drawing includes cover plate.

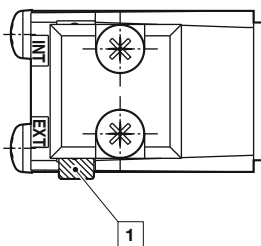

1 Blue gasket

Air pilot actuated valves

External pilot supply.

Warning

These products are intended for use in industrial compressed air systems only. Do not use these products where pressures and temperatures can exceed those listed under »**Technical features/data**«.

Before using these products with fluids other than those specified, for non-industrial applications, life-support systems or other applications not within published specifications, consult IMI Precision Engineering, IMI International s.r.o.

Through misuse, age, or malfunction, components used in fluid power systems can fail in various modes. The system designer is warned to consider the failure modes of all component parts used in fluid power systems and to provide adequate safeguards to prevent personal injury or damage to equipment in the event of such failure.

System designers must provide a warning to end users in the system instructional manual if protection against a failure mode cannot be adequately provided.

System designers and end users are cautioned to review specific warnings found in instruction sheets packed and shipped with these products.